

**Weatherly # 500**  
Replaces 2015  
Automotive Catalog  
Stock # 99948



*THE IGNITION SPECIALIST™*

# *SPARK PLUG CATALOG*

Automotive





NGK Spark Plugs leads the industry in spark plug technology, developing OE and aftermarket solutions for domestic and import vehicles of today and tomorrow.

THE IGNITION SPECIALIST™



### Original Equipment Spark Plugs

- Laser Iridium
- Laser Platinum
- V-Power
- Nickel

Original equipment for many auto, marine, powersports and power equipment applications.



### RUTHENIUM HX™

Offers the highest performance and life expectancy of any Aftermarket spark plug line due to the metal composition and specialized tip design.



### NGK IRIDIUM IX®

Better performance upgrade for all vehicles. Extreme ignitability, throttle response and anti-fouling properties.



### G-POWER®

Affordable replacement over original equipment plugs. Ideal for all vehicles

**INFORMATION AND PRODUCT PAGES**

Design Symbols: Spark Plugs .....	2
Spark Plug Conditions .....	4
Replace Spark Plugs .....	5
Ruthenium HX.....	6
Features of Spark Plugs.....	8
Original Equipment Iridium and Platinum Spark Plugs.....	9
New Part Numbers / Discontinued Numbers / New Applications .....	22
Spark Plug Specification Index.....	25
Spark Plug Specification Chart.....	26
Racing Spark Plug Specification Chart.....	64

**APPLICATIONS**

Passenger Cars, Trucks, Vans and SUV's.....	70
---	----

**SPARK PLUG BUYERS GUIDE**

Primary Application Guide.....	252
Spark Plugs - Cross Reference.....	408
NGK - Stock Number to Part Number .....	449
NGK - Part Number to Stock Number .....	453
Top Selling Spark Plugs.....	457

**SPARK PLUG TROUBLESHOOTING AND REFERENCE GUIDE**

Introduction.....	458
Heat Range Explanation.....	459
Influences on Spark Plug Temperatures/Performance .....	461
Installation Recommendations.....	463
Product Warranty.....	464

**IMPORTANT NOTICE:**

Applications listed in this catalog do not apply to aircraft, racing or modified engines, except where explicitly noted.

# Design Symbols

B		P		5	E		S		-11	
Thread Dimensions / Hex. Size		Construction (One or more letters may be combined)		Heat Rating	Thread Reach		Firing End Construction		Spark Gap	
A	18mm / 1" (25.4mm)	L	Compact Type	2	E	19.0mm (3/4")	A	Special Design	None	Motorcycle: 0.7 - 0.8 mm Car: 0.8 - 0.9 mm
AB	18mm / 13/16" (20.8mm)	M	Compact Type (Bantam) 3/4" Hex Size	4	EH	19.0mm (3/4") Half Thread	B	Integral Terminal (Solid)	-6	0.6mm (.024")
B	14mm / 13/16" (20.8mm)	P	Projecting Insulator Type	5	H	12.7mm (1/2")	C	Low Angle Ground Electrode	-7	0.7mm (.028")
BC	14mm / 5/8" (16.0mm) JIS Type	R	Resistor Type	6	L	11.2mm (7/16")	CM	Low Angle Ground Electrode Compact Type (Insulator Length:18.5mm)	-8	0.8mm (.032")
BK	14mm / 5/8" (16.0mm) ISO Type	U	Surface Gap, Semi-Surface Discharge Gap or Supplementary Gap Inductive Resistor Type	7	S	9.5mm (3/8")	E	V-Grooved Center Electrode (14mm only) 1.5mm Insulator Projection	-9	0.9mm (.036")
C	10mm / 5/8" (16.0mm)			8	Z	9	Z	21mm	F	Tapered Seat
D	12mm (18.0 mm)	Z	Inductive Resistor Type	9	Bantam Type		G	Fine Wire Nickel Alloy Center Electrode	-11	1.1mm (.044")
DC	12mm / 5/8" (16.0mm)			10			-G	Copper Core Ground Electrode	-13	1.3mm (.052")
E	8mm / 13.0mm	Hot Type	Cold Type	11	BM---	9.5mm (3/8')	GP	Platinum Alloy Fine Wire	-14	1.4mm (.055")
J	12mm / 5/8" (16.0mm)			BPM---	9.5mm (3/8')	GV	Gold-Palladium Center Electrode (Racing Line)	-15	1.5mm (.060")	
				CM---	9.5mm (3/8')	HX	Special Design			
				Tapered Seat		I	Single Iridium Spark Plug			
						IX	High Performance Iridium (0.6mmØ)			
				A-F---	10.9mm	K	2-Ground Electrode	-S	Special Gasket	
				B-F---	11.2mm (7/16")	-L	Medium Heat Rating	-E	Special Resistance	
				B-EF---	17.5mm (.708") Reach 5/8" Hex Size	-LM	Compact Type (Insulator Length:14.5mm)			
				BM-F---	7.8mm	N	Special Ground Electrode			
				No Symbol		P	Premium Platinum			
						Q	4-Ground Electrode			
		18mmØ	12mm Reach	S	Standard Type (2.5mm Center Electrode)					
		14mmØ	9.5mm (3/8') Reach	T	3-Ground Electrode					
				U	Semi-Surface Discharge					
				V	Fine Wire Gold-Palladium Center Electrode					
				VX	High Performance Platinum					
				W	Tungsten Electrode					
				Y	V-Grooved Center Electrode (14mm only) 2.5mm Insulator Projection					
				YA	Fouling Resistant					
				Z	Thick 2.9mm Center Electrode					



I		T				R	4	A	15				
(One or more letters may be combined)		Thread	Reach	Seat Type	Hex	RESISTOR	Heat Rating	Firing End Construction		Spark Gap			
D	High ignitability plug with double fine electrode	KA	ø12.0	19.0mm, (3/4")	Gasket		14.0mm	2	Hot Type	A,B,C... Special Code		None	Motorcycle: 0.7-0.8mm Car: 0.8-0.9mm
I	Premium Iridium	KB	ø12.0	19.0mm, (3/4")	Gasket		Bi-Hex, 14mm	4				-7	0.7mm, (.028")
LF	Long thread reach plug Gasket type (26.55mm reach)	MA	ø10.0	19.0mm (3/4")	Gasket		14.0mm	5					-9
IT	Long thread reach plug Tapered seat type (25mm reach)	NA	ø12.0	26.5mm	Tapered		16.0mm, (5/8")	6	I	Single Iridium Spark Plug	-10	1.0mm, (.040")	
P	Premium Platinum	F	ø14.0	19.0mm, (3/4")	Gasket		20.8mm, (13/16")	7	p	Single Platinum Spark Plug	-11	1.1mm, (.044")	
S	Square Tip Type	G	ø14.0	19.0mm, (3/4")	Gasket		18.0mm	8			-13	1.3mm, (.052")	
Z	Extended Projection	J	ø12.0	19.0mm, (3/4")	Gasket		16.0mm, (5/8")	9	zgr-b	1.5 mm Ext. Metal Shell Reach	-14	1.4mm, (.055")	
Above letters are occasionally used in combination. Ex. ILFR, ILZTR  "L", Long thread reach is prior to other letters which stand for thread reach. Exception: PTR5A-13; reach 25 mm  Ex. Gasket type FR5AP-11; reach 19 mm LFR5AP-11; reach 26.5mm  Ex. Tapered-seat type PTR5C-13; reach 17.5 mm PLTR6A-10G; reach 25 mm		K	ø12.0	19.0mm, (3/4")	Gasket		16.0mm, (5/8")	10	zgr-c	3 mm Ext. Metal Shell Reach	-15	1.5mm, (.060")	
		L	ø10.0	12.7mm, (1/2")	Gasket		16.0mm, (5/8")	11	zgr-d	3.5 mm Ext. Metal Shell Reach	-A		Non Gasket
		M	ø10.0	19.0mm, (3/4")	Gasket		16.0mm, (5/8")	zgr-e		3.5 mm Ext. Metal Shell Reach	-B	Special Design	
		T	ø14.0	17.5mm, (0.708")	Tapered	16.0mm, (5/8")			-C	Special Design			
		U	ø14.0	11.2mm, (7/16")	Tapered	20.8mm, (13/16")			-D	Metal Shell Plating Spec Change			
		W	ø18.0	10.9mm	Tapered	20.8mm, (13/16")			-E	Special Resistance			
		X	ø14.0	9.5mm, (3/8")	Gasket	20.8mm, (13/16")			-G	Copper Core Ground Electrode			
		Y	ø14.0	11.2mm, (7/16")	Tapered	16.0mm, (5/8")			-H	Special Thread Type			
		PTR5A-13		ø14.0	25.0mm	Tapered	16.0mm, (5/8")			-J	2-Ground Electrode		
										-K	Vibration-resistant Ground Electrode		
								-N	Special Ground Electrode				
								-Q	4-Ground Electrode				
								-S	Special Gasket				
								-T	3-Ground Electrode				

T					R	5	5	-1	IX					
Thread Dimension / Hex Size					RESISTOR	Heat Rating	Spark Gap		Special Design Type		Firing End Construction			
F	ø14.0	19.0mm, (3/4")	Gasket	Projected		16.0mm	2	Hot Type	None	1.0 mm (.040")	F-1	3.0 mm Ext. Metal Shell Reach	None	3.0 mm Ext. Metal Shell Reach
G	ø14.0	19.0mm, (3/4")	Gasket	Projected		20.8mm, (13/16")	4		5	1.5mm (.060")	T-1	3.0 mm Ext. Metal Shell Reach	IX	3.0 mm Ext. Metal Shell Reach
T	ø14.0	17.5mm, (.708")	Tapered	Projected		16.0mm, (5/8")	5				W-1	13.7mm Thread Reach	GP	13.7mm Thread Reach
U	ø14.0	11.2mm, (7/16")	Tapered	Projected		16.0mm (5/8")	6			HX	Special Design			
W	ø18.0	10.9mm	Tapered	Projected		20.8mm, (13/16")	7							
X	ø14.0	9.5mm, (3/8")	Gasket	Projected		20.8mm, (13/16")	8							
Y	ø14.0	11.2mm, (7/16")	Tapered	Non-Projected		16.0mm, (5/8")	9							
						10								
						11								

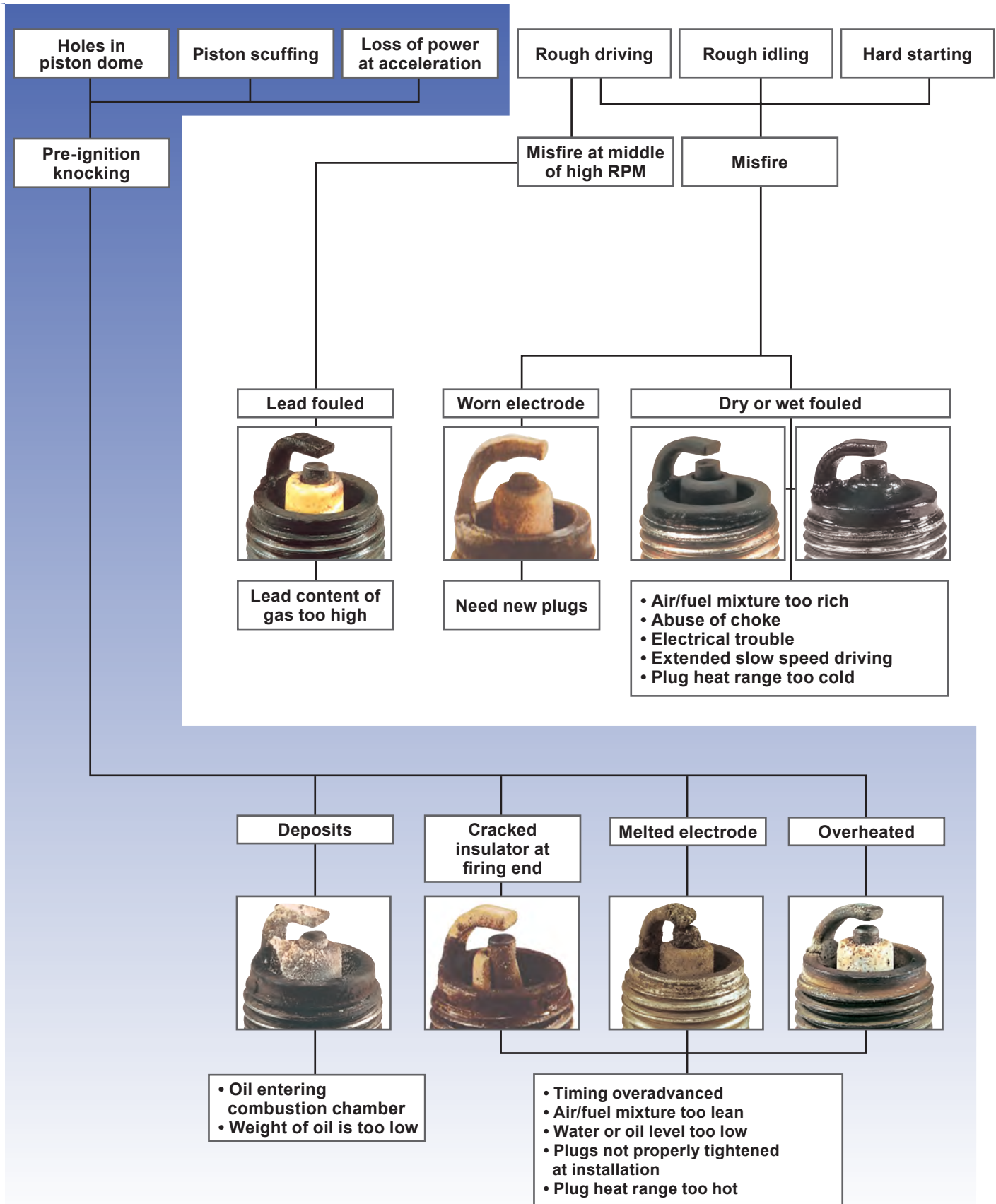



THE IGNITION SPECIALIST™

# REASONS TO REPLACE PLUGS

**#1** *Optimal performance*

 *Quicker starts*

 *Reduces fouling*

 *Better fuel efficiency*

 *Less down time*

 **MORE DRIVE TIME**





# RUTHENIUM<sup>TM</sup> HX

High Ignitability Spark Plugs

## Patented OEM Ruthenium Technology

Provides greater durability than traditional Iridium/  
Platinum spark plugs in high heat engines

## Enhanced blistering/ anti-peeling

Prevents physical wear-out and the peeling  
of microparticles on the center electrode

## Superior oxidation resistance

Prevents chemical breakdown  
of the center electrode

## Advanced high- ignitability technology

Provides the most  
complete fuel  
burn



## How does NGK RUTHENIUM HX<sup>TM</sup> compare to other spark plugs?

NGK's patented Ruthenium technology allows for faster and greater flame growth, resulting in 50% more complete fuel combustion vs. nickel spark plugs. NGK RUTHENIUM HX<sup>TM</sup> provides twice the service life of NGK IRIDIUM IX<sup>®</sup>.

Patented specialized OEM designs to meet the demands of modern engines.

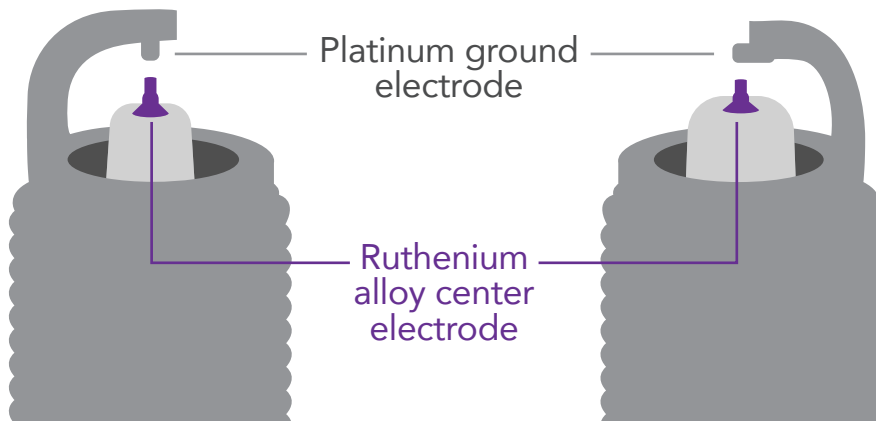

**Double Fine Electrode  
(DFE) design**

**Projected Square Platinum  
Electrode PSPE<sup>®</sup> design**



## DURABILITY

NGK's patented Ruthenium technology is available in our most advanced OEM designs to provide the most optimal durability at high temperatures in various driving conditions.

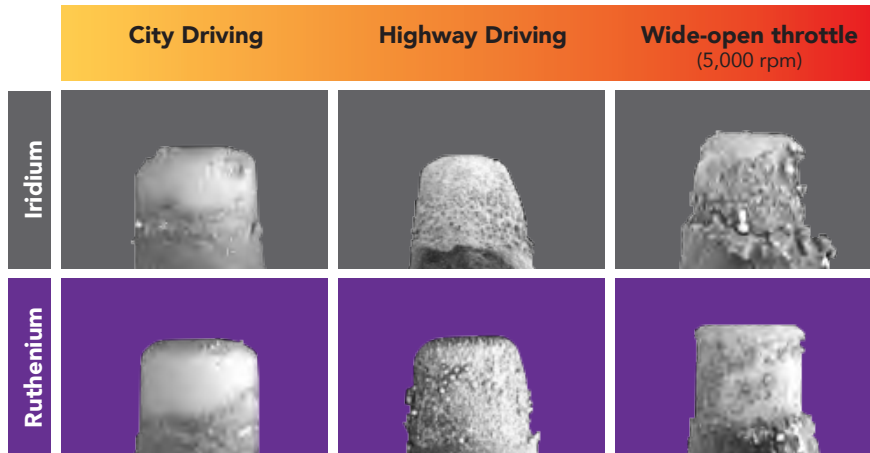

## TESTING & MANUFACTURING

All NGK spark plugs must pass extensive testing procedures and quality checks to ensure fit and performance.

- Combustion pressure testing to maintain stable performance (Diagram 1)
- Acceleration testing for improved acceleration performance (Diagram 2)
- Mechanical vibration testing
- Thermal shock testing to -40°F
- Tightest resistor manufacturing process in the industry
- Manufacturing in our ISO 11565 certified manufacturing facility
- Gap measurement with laser precision throughout production process
- Center electrodes are accurately positioned with 360° welding process

### COMBUSTION PRESSURE TEST *Diagram 1*

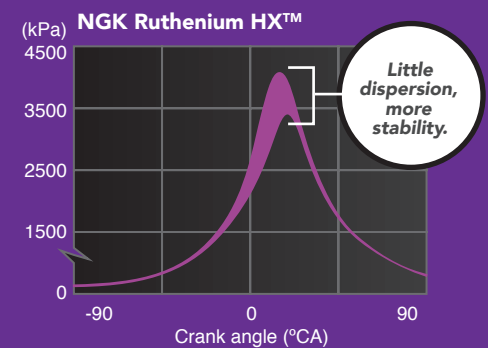

### ACCELERATION TEST *Diagram 2*

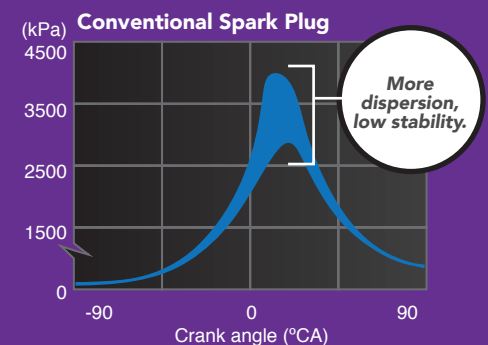
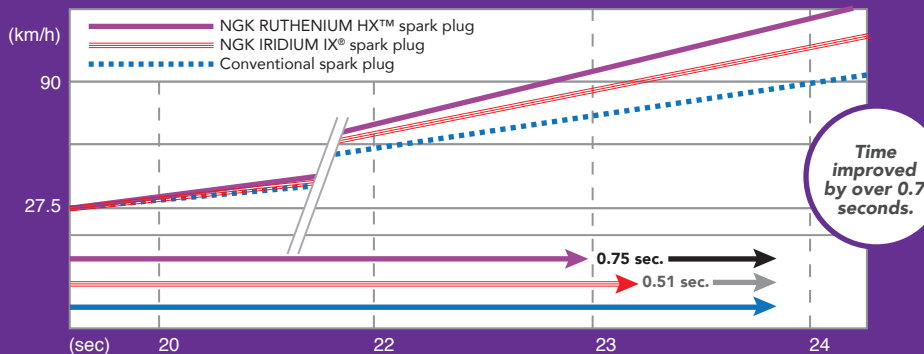



# The NGK Difference

**High-grade alumina silicate ceramic** - Creates a stronger insulator to reduce dielectric punch-through (caused by spark exiting through side of ceramic).

**Corrugated ribs** - Prevents "flashover" of spark, which can lead to harmful misfires and rob you of performance.

**Triple gasket sealing process** - virtually eliminates the possibility of combustion gas leakage back through the shell.

**98% pure copper core** - Increased heat dissipation for reliable starts, prevents spark plug overheating.

**Custom designed ground and center electrodes**

**Longer insulator nose** - this superior design, sometimes called a "power tip". Prevents loading up or fouling, even after prolonged periods of idling, or at slow speeds.

**Cold-rolled threads** - Prevents cross-threading and damage to cylinder heads.

**Trivalent metal plating** - No anti-seize required.





## Original Equipment Iridium and Platinum Spark Plugs

YEAR	MODEL	ENGINE	NGK PART #	STOCK #
<b>ACURA</b>				
1999-98	CL	L4 2.3L	PZFR5F-11	4363
1999-97	CL	V6 3.0L	PZFR5F-11	4363
2003-01	CL	V6 3.2L	PZFR5F-11	4363
2003-01	CL	V6 3.2L	PZFR6E-11	7790
2010-07	CSX	L4 2.0L	IFR7G-11KS	7746
2011-06	CSX	L4 2.0L	IZFR6K11	6994
2000-97	EL	L4 1.6L	PZFR5F-11	4363
2005-01	EL	L4 1.7L	PZFR6F-11	3271
2015-13	ILX	L4 1.5L	DILFR6J11	92491
2015-13	ILX	L4 2.0L	DILZKR7B11GS	95710
2017-16	ILX	L4 2.4L	DILKAR7H11GS	96964
2015-13	ILX	L4 2.4L	ILZKR7B-11S	5787
1993-92	INTEGRA	L4 1.7L	PFR6G-13	4115
2000-97	INTEGRA	L4 1.8L	PFR6G-11	5555
2001-94	INTEGRA	L4 1.8L	PFR6G-13	4115
2001-01	INTEGRA	L4 1.8L	PFR7G-11	2380
2001-00	INTEGRA	L4 1.8L	PZFR5F-11	4363
1995-91	LEGEND	V6 3.2L	PFR6G-11	5555
2017-14	MDX	V6 3.5L	DILZKR7B11G	95350
2006-03	MDX	V6 3.5L	IZFR5K11	3657
2002-01	MDX	V6 3.5L	PZFR5F-11	4363
2013-10	MDX	V6 3.7L	ILZKR7B-11S	5787
2009-07	MDX	V6 3.7L	IZFR6K11	6994
1994-91	NSX	V6 3.0L	PFR6G-11	5555
2005-97	NSX	V6 3.0L	PFR6L-11	4639
1996-95	NSX	V6 3.0L	PFR6N-11	3546
2005-97	NSX	V6 3.2L	PFR6L-11	4639
2012-07	RDX	L4 2.3L	SILKR8A-S	1402
2018-13	RDX	V6 3.5L	ILZKR7B11	7751
2008-05	RL	V6 3.5L	IZFR6K11	6994
2004-96	RL	V6 3.5L	PFR5L-11	5459
2012-09	RL	V6 3.7L	ILZKR7B-11S	5787
2017-14	RLX	V6 3.5L	DILZKR7B11G	95350
2006-02	RSX	L4 2.0L	IFR7G-11KS	7746
2006-02	RSX	L4 2.0L	IZFR6K11	6994
1997-96	SLX	V6 3.2L	PFR5G-11	2647
2008-04	TL	V6 3.2L	IZFR6K11	6994
1998-96	TL	V6 3.2L	PFR5L-11	5459
2003-99	TL	V6 3.2L	PZFR5F-11	4363
2003-02	TL	V6 3.2L	PZFR6E-11	7790
2014-13	TL	V6 3.5L	DILZKR7A11G	92924
2012-09	TL	V6 3.5L	ILZKR7B11	7751
2008-07	TL	V6 3.5L	IZFR6K11	6994
2014-09	TL	V6 3.7L	ILZKR7B-11S	5787
2018-15	TLX	L4 2.4L	DILKAR7H11GS	96964
2018-15	TLX	V6 3.5L	DILZKR7B11G	95350
2014-09	TSX	L4 2.4L	ILZKR7B-11S	5787
2008-04	TSX	L4 2.4L	IZFR6K11	6994
2014-10	TSX	V6 3.5L	ILZKR7B11	7751
2013-10	ZDX	V6 3.7L	ILZKR7B-11S	5787
<b>ALFA ROMEO</b>				
1995-91	164	V6 3.0L	PFR6B	3500
<b>ASTON MARTIN</b>				
2004-04	DB7	V12 6.0L	PTR5D-10	3784
2003-02	DB7	V12 6.0L	PTR5D-13	6644
2000-00	DB7	V12 6.0L	PTR6D-13	5598
2006-02	VANQUISH	V12 6.0L	PTR6D-13	5598
<b>AUDI</b>				
2013-09	A3 QUATTRO	L4 2.0L	PFR7S8EG	1675
2017-15	A3 QUATTRO	L4 2.0L	PLFER7A8EG	94833
2009-06	A3 QUATTRO	V6 3.2L	IZKR7B	7563
2016-15	A3	L4 1.8L	PLFER7A8EG	94833
2013-10	A3	L4 2.0L	PFR7S8EG	1675
2017-17	A3	L4 2.0L	PLFER7A8EG	94833
2016-13	A4 ALLROAD	L4 2.0L	PFR7S8EG	1675
2017-17	A4 ALLROAD	L4 2.0L	PLFER7A8EG	94833
2005-00	A4 QUATTRO	L4 1.8L	PFR6Q	6458
2016-10	A4 QUATTRO	L4 2.0L	PFR7S8EG	1675
2017-17	A4 QUATTRO	L4 2.0L	PLFER7A8EG	94833

YEAR	MODEL	ENGINE	NGK PART #	STOCK #
<b>AUDI</b>				
2006-02	A4 QUATTRO	V6 3.0L	PFR6U-11G	5874
2009-09	A4 QUATTRO	V6 3.2L	PFR6X-11	5757
2009-05	A4 QUATTRO	V6 3.2L	PFR7W-TG	5592
2006-00	A4	L4 1.8L	PFR6Q	6458
2016-10	A4	L4 2.0L	PFR7S8EG	1675
2017-17	A4	L4 2.0L	PLFER7A8EG	94833
2005-02	A4	V6 3.0L	PFR6U-11G	5874
2008-06	A4	V6 3.2L	PFR7W-TG	5592
2017-10	A5 QUATTRO	L4 2.0L	PFR7S8EG	1675
2010-08	A5 QUATTRO	V6 3.2L	PFR6X-11	5757
2014-10	A5	L4 2.0L	PFR7S8EG	1675
2015-13	A6 QUATTRO	L4 2.0L	PFR7S8EG	1675
2017-16	A6 QUATTRO	L4 2.0L	PLFER7A8EG	94833
2004-00	A6 QUATTRO	V6 2.7L	PFR6Q	6458
2004-02	A6 QUATTRO	V6 3.0L	PFR6U-11G	5874
2017-09	A6 QUATTRO	V6 3.0L	PFR8S8EG	94460
2008-05	A6 QUATTRO	V6 3.2L	PFR7W-TG	5592
2011-07	A6 QUATTRO	V8 4.2L	PFR6W-TG	5547
2015-12	A6	L4 2.0L	PFR7S8EG	1675
2017-16	A6	L4 2.0L	PLFER7A8EG	94833
2004-02	A6	V6 3.0L	PFR6U-11G	5874
2011-09	A6	V6 3.2L	PFR6X-11	5757
2008-06	A6	V6 3.2L	PFR7W-TG	5592
2017-12	A7 QUATTRO	V6 3.0L	PFR8S8EG	94460
2017-13	A8 QUATTRO	V6 3.0L	PFR8S8EG	94460
2006-00	A8 QUATTRO	V8 4.2L	BKR6EQUP	3199
2012-07	A8 QUATTRO	V8 4.2L	PFR6W-TG	5547
2009-05	A8 QUATTRO	W12 6.0L	PZFR6J-11	3586
2016-12	A8 QUATTRO	W12 6.3L	ILZKR8A	94290
2002-01	ALLROAD QUATTRO	V6 2.7L	PFR6Q	6458
2015-13	ALLROAD	L4 2.0L	PFR7S8EG	1675
2016-16	ALLROAD	L4 2.0L	PLFER7A8EG	94833
2017-15	Q3 QUATTRO	L4 2.0L	PFR7S8EG	1675
2017-15	Q3	L4 2.0L	PFR7S8EG	1675
2017-11	Q5	L4 2.0L	PFR7S8EG	1675
2017-13	Q5	V6 3.0L	PFR8S8EG	94460
2012-09	Q5	V6 3.2L	PFR6X-11	5757
2017-17	Q7	L4 2.0L	PLFER7A8EG	94833
2017-11	Q7	V6 3.0L	PFR8S8EG	94460
2010-07	Q7	V6 3.6L	ILZKR7A	1961
2010-07	Q7	V8 4.2L	PFR6W-TG	5547
2017-11	R8	V10 5.2L	PFR7S8EG	1675
2010-10	R8	V10 5.2L	PFR7W-TG	5592
2015-11	R8	V8 4.2L	PFR7S8EG	1675
2010-08	R8	V8 4.2L	PFR7W-TG	5592
2008-07	RS4	V8 4.2L	PFR7W-TG	5592
2015-13	RS5	V8 4.2L	PFR7S8EG	1675
2004-03	RS6	V8 4.2L	PFR7Q	7963
2017-15	S3	L4 2.0L	PLFER7A8EG	94833
2002-00	S4	V6 2.7L	PFR6Q	6458
2016-10	S4	V6 3.0L	PFR8S8EG	94460
2017-10	S5	V6 3.0L	PFR8S8EG	94460
2012-08	S5	V8 4.2L	PFR6W-TG	5547
2011-07	S6	V10 5.2L	PFR6W-TG	5547
2009-07	S8	V10 5.2L	PFR6W-TG	5547
2017-14	SQ5	V6 3.0L	PFR8S8EG	94460
2006-00	TT QUATTRO	L4 1.8L	PFR6Q	6458
2015-10	TT QUATTRO	L4 2.0L	PFR7S8EG	1675
2017-16	TT QUATTRO	L4 2.0L	PLFER7A8EG	94833
2009-04	TT QUATTRO	V6 3.2L	IZKR7B	7563
2003-03	TT	L4 1.8L	IZKR7B	7563
2006-00	TT	L4 1.8L	PFR6Q	6458
2009-08	TT	L4 2.0L	PFR7S8EG	1675
<b>BENTLEY</b>				
1999-99	ARNAGE	V8 4.4L	BKR6EQUP	3199
2010-03	CONTINENTAL	W12 6.0L	PZFR6J-11	3586
<b>BMW</b>				
2013-10	128i	L6 3.0L	LZFR6AP11GS	95712
2009-08	128i	L6 3.0L	PLZFR6A-11S	5987

Note: Please refer to application section for detailed model listing



# Original Equipment Iridium and Platinum Spark Plugs

THE IGNITION SPECIALIST

YEAR	MODEL	ENGINE	NGK PART #	STOCK #
BMW				
2016-15	228i XDRIVE	L4 2.0L	SILZKBR8D8S	97506
2016-14	228i	L4 2.0L	SILZKBR8D8S	97506
2017-13	320i XDRIVE	L4 2.0L	SILZKBR8D8S	97506
2017-12	320i	L4 2.0L	SILZKBR8D8S	97506
1995-92	320i	L6 2.0L	BKR6EQUP	3199
2005-01	320i	L6 2.2L	BKR6EQUP	3199
2000-00	323CI	L6 2.5L	BKR6EQUP	3199
2000-98	323i	L6 2.5L	BKR6EQUP	3199
2007-06	323i	L6 2.5L	ILZFR6D11	1208
2011-10	323i	L6 2.5L	LZFR6AP11GS	95712
2009-08	323i	L6 2.5L	PLZFR6A-11S	5987
1999-98	323iS	L6 2.5L	BKR6EQUP	3199
2006-01	325CI	L6 2.5L	BKR6EQUP	3199
2005-01	325i	L6 2.5L	BKR6EQUP	3199
2006-06	325i	L6 3.0L	ILZFR6D11	1208
2005-01	325Xi	L6 2.5L	BKR6EQUP	3199
2006-06	325Xi	L6 3.0L	ILZFR6D11	1208
2000-00	328CI	L6 2.8L	BKR6EQUP	3199
2016-14	328i GT XDRIVE	L4 2.0L	SILZKBR8D8S	97506
2016-13	328i XDRIVE	L4 2.0L	SILZKBR8D8S	97506
2013-10	328i XDRIVE	L6 3.0L	LZFR6AP11GS	95712
2009-09	328i XDRIVE	L6 3.0L	PLZFR6A-11S	5987
2016-12	328i	L4 2.0L	SILZKBR8D8S	97506
2000-96	328i	L6 2.8L	BKR6EQUP	3199
2007-07	328i	L6 3.0L	ILZFR6D11	1208
2013-10	328i	L6 3.0L	LZFR6AP11GS	95712
2009-08	328i	L6 3.0L	PLZFR6A-11S	5987
1999-96	328iS	L6 2.8L	BKR6EQUP	3199
2007-07	328Xi	L6 3.0L	ILZFR6D11	1208
2008-08	328Xi	L6 3.0L	PLZFR6A-11S	5987
2006-01	330CI	L6 3.0L	BKR6EQUP	3199
2017-17	330E	L4 2.0L	SILZKGR8B8S	94201
2017-17	330i	L4 2.0L	SILZKGR8B8S	94201
2005-01	330i	L6 3.0L	BKR6EQUP	3199
2006-06	330i	L6 3.0L	ILZFR6D11	1208
2005-01	330Xi	L6 3.0L	BKR6EQUP	3199
2006-06	330Xi	L6 3.0L	ILZFR6D11	1208
2017-17	340i GT XDRIVE	L6 3.0L	SILZKGR8B8S	94201
2017-16	340i XDRIVE	L6 3.0L	SILZKGR8B8S	94201
2017-16	340i	L6 3.0L	SILZKGR8B8S	94201
2016-15	428i GRAN COUPE	L4 2.0L	SILZKBR8D8S	97506
2016-15	428i XDRIVE GRAN COUPE	L4 2.0L	SILZKBR8D8S	97506
2016-14	428i XDRIVE	L4 2.0L	SILZKBR8D8S	97506
2016-14	428i	L4 2.0L	SILZKBR8D8S	97506
2017-17	440i	L4 2.0L	SILZKGR8B8S	94201
2017-17	440i GRAN COUPE	L6 3.0L	SILZKGR8B8S	94201
2017-17	440i XDRIVE GRAN COUPE	L6 3.0L	SILZKGR8B8S	94201
2017-17	440i XDRIVE	L6 3.0L	SILZKGR8B8S	94201
2017-17	440i	L6 3.0L	SILZKGR8B8S	94201
2005-01	525i	L6 2.5L	BKR6EQUP	3199
2007-06	525i	L6 3.0L	ILZFR6D11	1208
2007-06	525Xi	L6 3.0L	ILZFR6D11	1208
2016-12	528i XDRIVE	L4 2.0L	SILZKBR8D8S	97506
2010-09	528i XDRIVE	L6 3.0L	PLZFR6A-11S	5987
2016-12	528i	L4 2.0L	SILZKBR8D8S	97506
2000-97	528i	L6 2.8L	BKR6EQUP	3199
2011-11	528i	L6 3.0L	LZFR6AP11GS	95712
2010-08	528i	L6 3.0L	PLZFR6A-11S	5987
2008-08	528Xi	L6 3.0L	PLZFR6A-11S	5987
2005-01	530i	L6 3.0L	BKR6EQUP	3199
2007-06	530i	L6 3.0L	ILZFR6D11	1208
2007-06	530Xi	L6 3.0L	ILZFR6D11	1208
2017-17	540i XDRIVE	L6 3.0L	SILZKGR8B8S	94201
2017-17	540i	L6 3.0L	SILZKGR8B8S	94201
2003-98	540i	V8 4.4L	BKR6EQUP	3199
2005-04	545i	V8 4.4L	BKR6EQUP	3199
2010-06	550i	V8 4.8L	IZFR6H11	4294
2005-04	645CI	V8 4.4L	BKR6EQUP	3199

YEAR	MODEL	ENGINE	NGK PART #	STOCK #
BMW				
2010-06	650i	V8 4.8L	IZFR6H11	4294
2017-17	740i XDRIVE	L6 3.0L	SILZKGR8B8S	94201
2017-16	740i	L6 3.0L	SILZKGR8B8S	94201
2001-98	740i	V8 4.4L	BKR6EQUP	3199
2001-98	740iL	V8 4.4L	BKR6EQUP	3199
2005-02	745i	V8 4.4L	BKR6EQUP	3199
2005-02	745Li	V8 4.4L	BKR6EQUP	3199
2008-06	750i	V8 4.8L	IZFR6H11	4294
2001-99	750iL	V12 5.4L	BKR6EQUP	3199
2008-06	750Li	V8 4.8L	IZFR6H11	4294
2006-04	760i	V12 6.0L	BKR6EQUP	3199
2008-03	760Li	V12 6.0L	BKR6EQUP	3199
2016-16	ALPINA B6 GRAN COUPE	V8 4.4L	SILZKBR8D8S	97506
2017-15	ALPINA B6 XDRIVE GRAN COUPE	V8 4.4L	SILZKBR8D8S	97506
2015-13	ALPINA B7 XDRIVE	V8 4.4L	SILZKBR8D8S	97506
2012-11	ALPINA B7 XDRIVE	V8 4.4L	SILZKBR8A8HS	1555
2008-07	ALPINA B7	V8 4.4L	PFR7B	4853
2015-13	ALPINA B7	V8 4.4L	SILZKBR8D8S	97506
2012-11	ALPINA B7	V8 4.4L	SILZKBR8A8HS	1555
2015-13	ALPINA B7L XDRIVE	V8 4.4L	SILZKBR8D8S	97506
2012-11	ALPINA B7L XDRIVE	V8 4.4L	SILZKBR8A8HS	1555
2015-13	ALPINA B7L	V8 4.4L	SILZKBR8D8S	97506
2012-11	ALPINA B7L	V8 4.4L	SILZKBR8A8HS	1555
2017-14	i8	L3 1.5L	SILZKGR8C8S	95248
2017-17	M240i XDRIVE	L6 3.0L	SILZKGR8B8S	94201
2017-17	M240i	L6 3.0L	SILZKGR8B8S	94201
1999-96	M3	L6 3.2L	BKR6EQUP	3199
2006-01	M3	L6 3.2L	DCPR8EKP	7415
2013-08	M3	V8 4.0L	LKR8AP	4471
2010-06	M5	V10 5.0L	LKR8AP	4471
2002-00	M5	V8 5.0L	BKR6EQUP	3199
2010-06	M6	V10 5.0L	LKR8AP	4471
2015-12	X1	L4 2.0L	SILZKBR8D8S	97506
2017-16	X1	L4 2.0L	SILZKGR8B8S	94201
2016-13	X3	L4 2.0L	SILZKBR8D8S	97506
2006-04	X3	L6 2.5L	BKR6EQUP	3199
2006-04	X3	L6 3.0L	BKR6EQUP	3199
2007-07	X3	L6 3.0L	ILZFR6D11	1208
2012-10	X3	L6 3.0L	LZFR6AP11GS	95712
2009-08	X3	L6 3.0L	PLZFR6A-11S	5987
2017-15	X4	L4 2.0L	SILZKBR8D8S	97506
2006-01	X5	L6 3.0L	BKR6EQUP	3199
2007-07	X5	L6 3.0L	ILZFR6D11	1208
2010-10	X5	L6 3.0L	LZFR6AP11GS	95712
2009-08	X5	L6 3.0L	PLZFR6A-11S	5987
2006-00	X5	V8 4.4L	BKR6EQUP	3199
2003-02	X5	V8 4.6L	BKR6EQUP	3199
2010-04	X5	V8 4.8L	IZFR6H11	4294
2002-99	Z3	L6 2.5L	BKR6EQUP	3199
2000-97	Z3	L6 2.8L	BKR6EQUP	3199
2002-01	Z3	L6 3.0L	BKR6EQUP	3199
2000-98	Z3	L6 3.2L	BKR6EQUP	3199
2002-01	Z3	L6 3.2L	DCPR8EKP	7415
2016-12	Z4	L4 2.0L	SILZKBR8D8S	97506
2005-03	Z4	L6 2.5L	BKR6EQUP	3199
2005-03	Z4	L6 3.0L	BKR6EQUP	3199
2007-06	Z4	L6 3.0L	ILZFR6D11	1208
2011-10	Z4	L6 3.0L	LZFR6AP11GS	95712
2009-08	Z4	L6 3.0L	PLZFR6A-11S	5987
2008-06	Z4	L6 3.2L	DCPR8EKP	7415
2003-03	Z8	V8 4.8L	BKR6EQUP	3199
2003-00	Z8	V8 5.0L	BKR6EQUP	3199
BUICK				
2010-10	ALLURE	L4 2.4L	ILTR5D	5476
2010-10	ALLURE	V6 3.0L	ILTR6E11	90117
2010-06	ALLURE	V6 3.6L	ILTR6E11	90117
2009-05	ALLURE	V6 3.8L	ITRA415	5599
2017-16	CASCADA	L4 1.6L	ILNAR8B7G	91970

Note: Please refer to application section for detailed model listing

## Original Equipment Iridium and Platinum Spark Plugs

YEAR	MODEL	ENGINE	NGK PART #	STOCK #
<b>BUICK</b>				
2005-02	CENTURY	V6 3.1L	ITR4A15	5599
2017-08	ENCLAVE	V6 3.6L	ILTR6E11	90117
2016-13	ENCORE	L4 1.4L	IFR7X7G	91039
2017-16	ENVISION	L4 2.0L	ILTR6M9G	94489
2017-17	ENVISION	L4 2.5L	ILTR5L11	96329
2016-10	LACROSSE	L4 2.4L	ILTR5D	5476
2010-10	LACROSSE	V6 3.0L	ILTR6E11	90117
2016-10	LACROSSE	V6 3.6L	ILTR6E11	90117
2009-05	LACROSSE	V6 3.8L	ITR4A15	5599
2005-94	LESABRE	V6 3.8L	ITR4A15	5599
2008-06	LUCERNE	V6 3.8L	ITR4A15	5599
2011-09	LUCERNE	V6 3.9L	IZTR4A11	4213
2005-94	PARK AVENUE	V6 3.8L	ITR4A15	5599
2007-07	RAINIER	L6 4.2L	ILTR5B11	3474
2013-11	REGAL	L4 2.0L	ILTR5D	5476
2017-14	REGAL	L4 2.0L	ILTR6M9G	94489
2017-11	REGAL	L4 2.4L	ILTR5D	5476
2004-94	REGAL	V6 3.8L	ITR4A15	5599
2005-02	RENDEZVOUS	V6 3.4L	ITR4A15	5599
2007-06	RENDEZVOUS	V6 3.5L	ITR4A15	5599
2006-06	RENDEZVOUS	V6 3.6L	PLTR6A-10G	3587
1999-95	RIVIERA	V6 3.8L	ITR4A15	5599
2006-05	TERRAZA	V6 3.5L	ITR4A15	5599
2007-06	TERRAZA	V6 3.9L	IZTR4A11	4213
2016-13	VERANO	L4 2.0L	ILTR5D	5476
2017-12	VERANO	L4 2.4L	ILTR5D	5476
<b>CADILLAC</b>				
2013-13	ATS	L4 2.0L	ILTR5M9G	90882
2017-14	ATS	L4 2.0L	ILTR6M9G	94489
2017-13	ATS	L4 2.5L	ILTR5L11	96329
2015-13	ATS	V6 3.6L	ILTR6E11	90117
2017-16	CT6	L4 2.0L	ILTR6M9G	94489
2017-16	CT6	V6 3.0L	ILTR7E9	90543
2017-14	CTS	L4 2.0L	ILTR6M9G	94489
2014-10	CTS	V6 3.0L	ILTR6E11	90117
2004-04	CTS	V6 3.2L	BKR6EQUP	3199
2015-11	CTS	V6 3.6L	ILTR6E11	90117
2014-14	CTS	V6 3.6L	ILTR7E9	90543
2016-14	ELR	L4 1.4L	IFR6Z7G	95609
2011-10	SRX	V6 2.8L	ILTR6E11	90117
2011-10	SRX	V6 3.0L	ILTR6E11	90117
2016-12	SRX	V6 3.6L	ILTR6E11	90117
2017-13	XTS	V6 3.6L	ILTR6E11	90117
2015-14	XTS	V6 3.6L	ILTR7E9	90543
<b>CHEVROLET</b>				
2005-98	ASTRO	V6 4.3L	ITR4A15	5599
2002-02	AVALANCHE 2500	V8 8.1L	PZTR5A-15	7862
2005-98	BLAZER	V6 4.3L	ITR4A15	5599
1998-98	C1500	V6 4.3L	ITR4A15	5599
2002-01	C3500HD	V8 8.1L	PZTR5A-15	7862
2017-16	CAMARO	L4 2.0L	ILTR6M9G	94489
2015-11	CAMARO	V6 3.6L	ILTR6E11	90117
2002-95	CAMARO	V6 3.8L	ITR4A15	5599
2017-12	CAPRICE	V6 3.6L	ILTR6E11	90117
2015-12	CAPTIVA SPORT	L4 2.4L	ILTR5D	5476
2012-12	CAPTIVA SPORT	V6 3.0L	ILTR6E11	90117
2005-02	CAVALIER	L4 2.2L	ILTR5C11	5581
2005-04	CLASSIC	L4 2.2L	ILTR5C11	5581
2007-05	COBALT	L4 2.0L	IFR6V-10G	92085
2010-08	COBALT	L4 2.0L	ILTR5D	5476
2008-06	COBALT	L4 2.2L	ILTR5B11	3474
2005-05	COBALT	L4 2.2L	ILTR5C11	5581
2010-09	COBALT	L4 2.2L	ILTR5E11	91418
2008-06	COBALT	L4 2.4L	ILTR5B11	3474
2016-15	COLORADO	L4 2.5L	ILTR5L11	96329
2009-07	COLORADO	L4 2.9L	ILTR5B11	3474
2012-10	COLORADO	L4 2.9L	ILTR5E11	91418
2009-07	COLORADO	L5 3.7L	ILTR5B11	3474
2012-10	COLORADO	L5 3.7L	ILTR5E11	91418
2016-15	COLORADO	V6 3.6L	ILTR6E11	90117

YEAR	MODEL	ENGINE	NGK PART #	STOCK #
<b>CHEVROLET</b>				
2016-16	CRUZE LIMITED	L4 1.4L	IFR7X7G	91039
2016-16	CRUZE LIMITED	L4 1.8L	IFR6Z7G	95609
2015-11	CRUZE	L4 1.4L	IFR7X7G	91039
2015-11	CRUZE	L4 1.8L	IFR6Z7G	95609
2006-05	EPICA	L6 2.5L	IFR6E11	6741
2017-10	EQUINOX	L4 2.4L	ILTR5D	5476
2012-10	EQUINOX	V6 3.0L	ILTR6E11	90117
2009-05	EQUINOX	V6 3.4L	ITR4A15	5599
2017-15	EQUINOX	V6 3.6L	ILTR6E11	90117
2014-98	EXPRESS 1500	V6 4.3L	ITR4A15	5599
2005-98	EXPRESS 2500	V6 4.3L	ITR4A15	5599
2010-08	HHR	L4 2.0L	ILTR5D	5476
2008-06	HHR	L4 2.2L	ILTR5B11	3474
2011-09	HHR	L4 2.2L	ILTR5E11	91418
2008-06	HHR	L4 2.4L	ILTR5B11	3474
2011-09	HHR	L4 2.4L	ILTR5E11	91418
2016-14	IMPALA LIMITED	V6 3.6L	ILTR6E11	90117
2014-14	IMPALA	L4 2.4L	ILTR5D	5476
2017-14	IMPALA	L4 2.5L	ILTR5L11	96329
2005-03	IMPALA	V6 3.4L	ITR4A15	5599
2011-06	IMPALA	V6 3.5L	IZTR4A11	4213
2017-12	IMPALA	V6 3.6L	ILTR6E11	90117
2005-00	IMPALA	V6 3.8L	ITR4A15	5599
2011-06	IMPALA	V6 3.9L	IZTR4A11	4213
1998-98	K1500	V6 4.3L	ITR4A15	5599
1995-94	LUMINA APV	V6 3.8L	ITR4A15	5599
1999-98	LUMINA	V6 3.8L	ITR4A15	5599
2016-16	MALIBU LIMITED	L4 2.5L	ILTR5L11	96329
2017-16	MALIBU	L4 1.8L	SILNAR7B7	93227
2013-13	MALIBU	L4 2.0L	ILTR5M9G	90882
2017-14	MALIBU	L4 2.0L	ILTR6M9G	94489
2008-07	MALIBU	L4 2.2L	ILTR5B11	3474
2006-04	MALIBU	L4 2.2L	ILTR5C11	5581
2008-08	MALIBU	L4 2.4L	ILTR5B11	3474
2014-13	MALIBU	L4 2.4L	ILTR5D	5476
2012-09	MALIBU	L4 2.4L	ILTR5E11	91418
2015-13	MALIBU	L4 2.5L	ILTR5L11	96329
2003-03	MALIBU	V6 3.1L	ITR4A15	5599
2006-04	MALIBU	V6 3.5L	ITR4A15	5599
2010-07	MALIBU	V6 3.5L	IZTR4A11	4213
2012-11	MALIBU	V6 3.6L	ILTR6E11	90117
2007-06	MALIBU	V6 3.9L	IZTR4A11	4213
2005-03	MONTE CARLO	V6 3.4L	ITR4A15	5599
2007-06	MONTE CARLO	V6 3.5L	IZTR4A11	4213
2005-98	MONTE CARLO	V6 3.8L	ITR4A15	5599
2006-06	MONTE CARLO	V6 3.9L	IZTR4A11	4213
1988-88	NOVA	L4 1.6L	BCPR5EP-11	2097
2014-12	ORLANDO	L4 2.4L	ILTR5D	5476
1999-98	P30	V6 4.3L	ITR4A15	5599
1998-98	P30	V8 7.4L	ITR4A15	5599
2002-00	PRIZM	L4 1.8L	IFR5T11	4996
2002-98	S10	L4 2.2L	ITR4A15	5599
2004-98	S10	V6 4.3L	ITR4A15	5599
2007-07	SILVERADO 1500 CLASSIC	V6 4.3L	ITR4A15	5599
2013-99	SILVERADO 1500	V6 4.3L	ITR4A15	5599
2004-01	SILVERADO 2500 HD	V8 8.1L	PZTR5A-15	7862
2004-01	SILVERADO 3500	V8 8.1L	PZTR5A-15	7862
2017-12	SONIC	L4 1.4L	IFR7X7G	91039
2017-12	SONIC	L4 1.8L	IFR6Z7G	95609
2017-16	SPARK	L4 1.4L	SILZNR6D9	94051
2002-99	TRACKER	L4 1.6L	IFR6E11	6741
2003-01	TRACKER	L4 2.0L	IFR5J11	7418
2000-99	TRACKER	L4 2.0L	IFR6E11	6741
2004-01	TRACKER	V6 2.5L	IFR5J11	7418
2006-06	TRAILBLAZER EXT	L6 4.2L	ILTR5B11	3474
2009-06	TRAILBLAZER	L6 4.2L	ILTR5B11	3474
2017-09	TRAVERSE	V6 3.6L	ILTR6E11	90117
2017-13	TRAX	L4 1.4L	IFR7X7G	91039

Note: Please refer to application section for detailed model listing



# Original Equipment Iridium and Platinum Spark Plugs

THE IGNITION SPECIALIST

YEAR	MODEL	ENGINE	NGK PART #	STOCK #
<b>CHEVROLET</b>				
2006-05	UPLANDER	V6 3.5L	ITR4A15	5599
2009-06	UPLANDER	V6 3.9L	IZTR4A11	4213
2005-02	VENTURE	V6 3.4L	ITR4A15	5599
2015-11	VOLT	L4 1.4L	IFR6Z7G	95609
2017-16	VOLT	L4 1.5L	SILZNR6D9	94051
<b>CHRYSLER</b>				
2014-11	200	L4 2.4L	ZFR5AP	92041
2005-05	300	V6 2.7L	PLZTR5A-13	4998
2010-05	300	V6 3.5L	ZFR5LP-13G	7781
2017-14	300	V8 5.7L	LZFR5CI-11	92145
2010-05	300	V8 6.1L	PLZTR5A-13	4998
2014-12	300	V8 6.4L	LZTR6AP11EG	97408
2004-02	300M	V6 3.5L	ZFR5LP-13G	7781
2009-09	ASPEN	V8 5.7L	PLZFR5B13EG	97606
2000-95	CIRRUS	V6 2.5L	PFR5G-11	2647
2004-02	CONCORDE	V6 3.5L	ZFR5LP-13G	7781
2006-05	CROSSFIRE	V6 3.2L	IFR6D10	5344
2008-04	CROSSFIRE	V6 3.2L	PFR5R-11	4292
2004-02	INTREPID	V6 3.5L	ZFR5LP-13G	7781
2006-04	PACIFICA	V6 3.5L	ZFR5LP-13G	7781
2008-07	PACIFICA	V6 4.0L	ZFR5LP-13G	7781
2002-02	PROWLER	V6 3.5L	ZFR5LP-13G	7781
2010-08	SEBRING	L4 2.4L	ZFR5AP	92041
2000-95	SEBRING	V6 2.5L	PFR5G-11	2647
2005-01	SEBRING	V6 3.0L	PFR6G-11	5555
2010-07	SEBRING	V6 3.5L	ZFR5LP-13G	7781
2010-08	TOWN & COUNTRY	V6 4.0L	ZFR5LP-13G	7781
<b>DODGE</b>				
2014-08	AVENGER	L4 2.4L	ZFR5AP	92041
2000-95	AVENGER	V6 2.5L	PFR5G-11	2647
2010-08	AVENGER	V6 3.5L	ZFR5LP-13G	7781
2010-08	CALIBER	L4 2.4L	ZFR5AP	92041
2010-09	CHALLENGER	V6 3.5L	ZFR5LP-13G	7781
2017-14	CHALLENGER	V8 5.7L	LZFR5CI-11	92145
2010-08	CHALLENGER	V8 6.1L	PLZTR5A-13	4998
2017-11	CHALLENGER	V8 6.4L	LZTR6AP11EG	97408
2010-06	CHARGER	V6 3.5L	ZFR5LP-13G	7781
2017-14	CHARGER	V8 5.7L	LZFR5CI-11	92145
2010-06	CHARGER	V8 6.1L	PLZTR5A-13	4998
2017-12	CHARGER	V8 6.4L	LZTR6AP11EG	97408
2016-13	DART	L4 1.4L	SIKR9A7	93618
2017-14	DURANGO	V8 5.7L	LZFR5CI-11	92145
2009-09	DURANGO	V8 5.7L	PLZFR5B13EG	97606
2010-08	GRAND CARAVAN	V6 4.0L	ZFR5LP-13G	7781
2004-02	INTREPID	V6 3.5L	ZFR5LP-13G	7781
2010-09	JOURNEY	L4 2.4L	ZFR5AP	92041
2010-09	JOURNEY	V6 3.5L	ZFR5LP-13G	7781
2005-05	MAGNUM	V6 2.7L	PLZTR5A-13	4998
2008-05	MAGNUM	V6 3.5L	ZFR5LP-13G	7781
2008-06	MAGNUM	V8 6.1L	PLZTR5A-13	4998
2011-07	NITRO	V6 4.0L	ZFR5LP-13G	7781
2008-07	SPRINTER 2500	V6 3.5L	PLKR7A	4288
2008-07	SPRINTER 3500	V6 3.5L	PLKR7A	4288
1996-91	STEALTH	V6 3.0L	PFR6J-11	2743
2005-04	STRATUS	L4 2.4L	PLZTR4A-13	4997
2000-95	STRATUS	V6 2.5L	PFR5G-11	2647
2005-01	STRATUS	V6 3.0L	PFR6G-11	5555
<b>FERRARI</b>				
2004-00	360	V8 3.6L	PMR8A	5851
2005-05	360	V8 3.6L	PMR8B	6378
2010-07	599 GTB	V12 6.0L	PMR8B	6378
2011-11	599 GTO	V12 6.0L	PMR8B	6378
2013-09	CALIFORNIA	V8 4.3L	SPMR8A6HDG	92264
2004-03	ENZO	V12 6.0L	PMR8B	6378
1998-98	F355 F1	V8 3.5L	PMR7A	4259
1998-94	F355 GTS	V8 3.5L	PMR7A	4259
1999-96	F355 SPIDER	V8 3.5L	PMR7A	4259
1999-99	F355	V8 3.5L	PMR7A	4259
2009-06	F430	V8 4.3L	PMR8B	6378

YEAR	MODEL	ENGINE	NGK PART #	STOCK #
<b>FERRARI</b>				
1997-95	F50	V12 4.7L	PMR7A	4259
<b>FIAT</b>				
2017-17	124 SPIDER	L4 1.4L	SIKR9A7	93618
2017-14	500	L4 1.4L	IKR7H8	91715
2017-12	500	L4 1.4L	SIKR9A7	93618
2017-14	500L	L4 1.4L	SIKR9A7	93618
2017-16	500X	L4 1.4L	SIKR9A7	93618
<b>FORD</b>				
2017-13	C-MAX	L4 2.0L	ILTR5K13	90607
2017-12	EDGE	L4 2.0L	ILTR6G8G	96621
2014-13	EDGE	L4 2.0L	LTR6DI-8	96588
2017-15	EDGE	V6 2.7L	ILTR7N8	95822
2011-07	EDGE	V6 3.5L	ILTR5K13	90607
2017-12	EDGE	V6 3.5L	LTR6BP13	94806
2014-11	EDGE	V6 3.7L	LTR6BP13	94806
2017-17	ESCAPE	L4 1.5L	ILZNR8A7G	91924
2016-13	ESCAPE	L4 1.6L	ILZTR6A8G	94769
2017-13	ESCAPE	L4 2.0L	LTR6DI-8	96588
2008-05	ESCAPE	L4 2.3L	ITR5H13	97287
2005-05	ESCAPE	L4 2.3L	ITR6F13	4477
2017-09	ESCAPE	L4 2.5L	ILTR5K13	90607
2008-01	ESCAPE	V6 3.0L	ITR5H13	97287
2009-09	ESCAPE	V6 3.0L	TR5BP12	93858
2017-15	EXPEDITION	V6 3.5L	LTR6CI-8	97177
2014-08	EXPEDITION	V8 5.4L	PZNR6A11H	5507
2010-08	EXPLORER SPORT TRAC	V8 4.6L	PZNR6A11H	5507
2013-12	EXPLORER	L4 2.0L	ILTR6G8G	96621
2015-14	EXPLORER	L4 2.0L	LTR6DI-8	96588
2017-16	EXPLORER	L4 2.3L	LTR6DI-8	96588
2017-11	EXPLORER	V6 3.5L	LTR6BP13	94806
2017-13	EXPLORER	V6 3.5L	LTR6CI-8	97177
2010-08	EXPLORER	V8 4.6L	PZNR6A11H	5507
2017-15	F-150	V6 2.7L	ILTR7N8	95822
2017-15	F-150	V6 3.5L	LTR6BP13	94806
2016-11	F-150	V6 3.5L	LTR6CI-8	97177
2014-11	F-150	V6 3.7L	LTR6BP13	94806
2010-09	F-150	V8 4.6L	PZNR6A11H	5507
2014-11	F-150	V8 5.0L	LTR6AI13	95853
2017-15	F-150	V8 5.0L	LTR6DP13	90374
2018-18	F-150	V8 5.0L	LTR7CP13	94862
2010-08	F-150	V8 5.4L	PZNR6A11H	5507
2010-08	F-250 SUPER DUTY	V10 6.8L	PZNR6A11H	5507
2010-08	F-250 SUPER DUTY	V8 5.4L	PZNR6A11H	5507
2010-08	F-350 SUPER DUTY	V10 6.8L	PZNR6A11H	5507
2010-08	F-350 SUPER DUTY	V8 5.4L	PZNR6A11H	5507
2017-08	F-450 SUPER DUTY	V10 6.8L	PZNR6A11H	5507
2017-08	F53	V10 6.8L	PZNR6A11H	5507
2017-08	F-550 SUPER DUTY	V10 6.8L	PZNR6A11H	5507
2017-11	F59	V10 6.8L	PZNR6A11H	5507
2013-12	F650	V10 6.8L	PZNR6A11H	5507
2017-14	FIESTA	L3 1.0L	SILZNR8C7H	93593
2017-11	FIESTA	L4 1.6L	ILTR6H8G	96870
2017-14	FIESTA	L4 1.6L	ILZTR6A8G	94769
2012-09	FLEX	V6 3.5L	ILTR5K13	90607
2017-12	FLEX	V6 3.5L	LTR6BP13	94806
2017-10	FLEX	V6 3.5L	LTR6CI-8	97177
2017-15	FOCUS	L3 1.0L	SILZNR8C7H	93593
2012-12	FOCUS	L4 2.0L	ILTR6F9	90656
2011-11	FOCUS	L4 2.0L	ITR5H13	97287
2005-05	FOCUS	L4 2.0L	ITR6F13	4477
2017-12	FOCUS	L4 2.0L	LTR6BI-9	92182
2017-13	FOCUS	L4 2.0L	LTR6DI-8	96588
2010-06	FOCUS	L4 2.0L	TR6AP-13	5809
2017-16	FOCUS	L4 2.3L	ILTR6G8G	96621
2007-03	FOCUS	L4 2.3L	ITR6F13	4477
2018-14	FUSION	L4 1.5L	ILZNR8A7G	91924
2014-13	FUSION	L4 1.6L	ILZTR6A8G	94769
2018-13	FUSION	L4 2.0L	ILTR5K13	90607

Note: Please refer to application section for detailed model listing



# Original Equipment Iridium and Platinum Spark Plugs

YEAR	MODEL	ENGINE	NGK PART #	STOCK #
<b>FORD</b>				
2018-17	FUSION	L4 2.0L	ILTR6G8G	96621
2016-13	FUSION	L4 2.0L	LTR6DI-8	96588
2009-06	FUSION	L4 2.3L	ILTR5K13	90607
2018-10	FUSION	L4 2.5L	ILTR5K13	90607
2018-17	FUSION	V6 2.7L	ILTR7N8	95822
2010-10	FUSION	V6 3.0L	TR5BP12	93858
2012-10	FUSION	V6 3.5L	ILTR5K13	90607
2017-15	MUSTANG	L4 2.3L	LTR6DI-8	96588
2017-11	MUSTANG	V6 3.7L	LTR6BP13	94806
2010-08	MUSTANG	V8 4.6L	PZNR6A11H	5507
2014-11	MUSTANG	V8 5.0L	LTR6A13	95853
2017-15	MUSTANG	V8 5.0L	LTR6DP13	90374
2018-18	MUSTANG	V8 5.0L	LTR7CP13	94862
2017-15	MUSTANG	V8 5.2L	LTR6DP13	90374
2014-13	MUSTANG	V8 5.8L	ITR6G9	90156
2017-13	POLICE INTERCEPTOR SEDAN	V6 3.5L	LTR6BP13	94806
2017-13	POLICE INTERCEPTOR SEDAN	V6 3.5L	LTR6CI-8	97177
2017-13	POLICE INTERCEPTOR SEDAN	V6 3.7L	LTR6BP13	94806
2017-14	POLICE INTERCEPTOR UTILITY	V6 3.5L	LTR6CI-8	97177
2017-13	POLICE INTERCEPTOR UTILITY	V6 3.7L	LTR6BP13	94806
2011-10	RANGER	L4 2.3L	ITR5H13	97287
2009-01	RANGER	L4 2.3L	PTR5F-11	6579
2017-14	SPECIAL SERVICE POLICE SEDAN	L4 2.0L	LTR6DI-8	96588
2009-08	TAURUS X	V6 3.5L	ILTR5K13	90607
2013-13	TAURUS	L4 2.0L	ILTR6G8G	96621
2017-14	TAURUS	L4 2.0L	LTR6DI-8	96588
1995-89	TAURUS	V6 3.0L	PFR5G-11	2647
1995-93	TAURUS	V6 3.2L	PFR5G-11	2647
2012-08	TAURUS	V6 3.5L	ILTR5K13	90607
2017-13	TAURUS	V6 3.5L	LTR6BP13	94806
2017-10	TAURUS	V6 3.5L	LTR6CI-8	97177
2016-14	TRANSIT CONNECT	L4 1.6L	ILZTR6A8G	94769
2013-10	TRANSIT CONNECT	L4 2.0L	ITR5H13	97287
2017-14	TRANSIT CONNECT	L4 2.5L	ILTR5K13	90607
2017-15	TRANSIT-150	V6 3.5L	LTR6CI-8	97177
2017-15	TRANSIT-150	V6 3.7L	LTR6BP13	94806
2017-15	TRANSIT-250	V6 3.5L	LTR6CI-8	97177
2017-15	TRANSIT-250	V6 3.7L	LTR6BP13	94806
2017-15	TRANSIT-350 HD	V6 3.5L	LTR6CI-8	97177
2017-15	TRANSIT-350 HD	V6 3.7L	LTR6BP13	94806
2017-15	TRANSIT-350	V6 3.5L	LTR6CI-8	97177
2017-15	TRANSIT-350	V6 3.7L	LTR6BP13	94806
<b>FREIGHTLINER</b>				
2008-07	SPRINTER 2500	V6 3.5L	PLKR7A	4288
2008-07	SPRINTER 3500	V6 3.5L	PLKR7A	4288
<b>GENESIS</b>				
2017-17	G80	V6 3.8L	DILKR7A11	93135
2018-18	G80	V6 3.8L	SILZKR7E11	92315
2017-17	G80	V8 5.0L	DILKR7A11	93135
<b>GMC</b>				
2017-17	ACADIA LIMITED	V6 3.6L	ILTR6E11	90117
2017-17	ACADIA	L4 2.5L	ILTR5L11	96329
2016-07	ACADIA	V6 3.6L	ILTR6E11	90117
1998-98	C1500	V6 4.3L	ITR4A15	5599
2002-01	C3500HD	V8 8.1L	PZTR5A-15	7862
2016-15	CANYON	L4 2.5L	ILTR5L11	96329
2006-04	CANYON	L4 2.8L	ILTR5B11	3474
2009-07	CANYON	L4 2.9L	ILTR5B11	3474
2012-10	CANYON	L4 2.9L	ILTR5E11	91418
2006-04	CANYON	L5 3.5L	ILTR5B11	3474
2009-07	CANYON	L5 3.7L	ILTR5B11	3474
2012-10	CANYON	L5 3.7L	ILTR5E11	91418
2016-15	CANYON	V6 3.6L	ILTR6E11	90117
2006-06	ENVOY XL	L6 4.2L	ILTR5B11	3474
2009-06	ENVOY	L6 4.2L	ILTR5B11	3474

YEAR	MODEL	ENGINE	NGK PART #	STOCK #
<b>GMC</b>				
2005-98	JIMMY	V6 4.3L	ITR4A15	5599
1998-98	K1500	V6 4.3L	ITR4A15	5599
1999-98	P3500	V6 4.3L	ITR4A15	5599
2005-98	SAFARI	V6 4.3L	ITR4A15	5599
2014-98	SAVANA 1500	V6 4.3L	ITR4A15	5599
2005-98	SAVANA 2500	V6 4.3L	ITR4A15	5599
2007-07	SIERRA 1500 CLAS-SIC	V6 4.3L	ITR4A15	5599
2013-99	SIERRA 1500	V6 4.3L	ITR4A15	5599
2002-01	SIERRA 3500	V8 8.1L	PZTR5A-15	7862
2004-98	SONOMA	V6 4.3L	ITR4A15	5599
2017-10	TERRAIN	L4 2.4L	ILTR5D	5476
2012-10	TERRAIN	V6 3.0L	ILTR6E11	90117
2017-13	TERRAIN	V6 3.6L	ILTR6E11	90117
<b>HONDA</b>				
2011-10	ACCORD CROSS-TOUR	V6 3.5L	ILZKR7B11	7751
2017-14	ACCORD	L4 2.0L	ILZKR7E11S	96509
2002-00	ACCORD	L4 2.3L	PZFR5F-11	4363
2017-13	ACCORD	L4 2.4L	DILKR7G11GS	91578
2012-08	ACCORD	L4 2.4L	DILZKR7B11GS	95710
2012-08	ACCORD	L4 2.4L	ILZKR7B-11S	5787
2007-03	ACCORD	L4 2.4L	IZFR6K11	6994
2007-03	ACCORD	L4 2.4L	IZFR6K13	6774
2007-03	ACCORD	V6 3.0L	IZFR6K11	6994
2007-03	ACCORD	V6 3.0L	IZFR6K13	6774
2002-98	ACCORD	V6 3.0L	PZFR5F-11	4363
2009-08	ACCORD	V6 3.5L	DILZKR7A11G	92924
2017-08	ACCORD	V6 3.5L	ILZKR7B11	7751
1997-94	CIVIC DEL SOL	L4 1.6L	PFR6L-13	3141
2005-03	CIVIC	L4 1.3L	IFR5G-11K	3107
2011-06	CIVIC	L4 1.3L	IFR6J-11K	4458
2015-12	CIVIC	L4 1.5L	DILFR6J11	92491
2017-16	CIVIC	L4 1.5L	ILZKR8H8S	95112
2017-17	CIVIC	L4 1.5L	ILZKR8J8SY	95660
2000-99	CIVIC	L4 1.6L	PFR6L-13	3141
2000-98	CIVIC	L4 1.6L	PFR7N8DS	93580
2005-01	CIVIC	L4 1.7L	PFR7N8DS	93580
2005-01	CIVIC	L4 1.7L	PZFR6F-11	3271
2015-12	CIVIC	L4 1.8L	DILZKR7B11GS	95710
2011-06	CIVIC	L4 1.8L	IFR7F-8DS	5794
2011-06	CIVIC	L4 1.8L	IZFR6K-11S	5266
2015-12	CIVIC	L4 1.8L	SILKR8B8DS	95705
2017-16	CIVIC	L4 2.0L	DILKR7G11GS	91578
2011-06	CIVIC	L4 2.0L	IFR7G-11KS	7746
2005-02	CIVIC	L4 2.0L	IZFR6K11	6994
2015-12	CIVIC	L4 2.4L	ILZKR7B-11S	5787
2015-12	CROSSTOUR	L4 2.4L	ILZKR7B-11S	5787
2015-12	CROSSTOUR	V6 3.5L	ILZKR7B11	7751
2017-17	CR-V	L4 1.5L	ILZKR8J8SY	95660
2017-15	CR-V	L4 2.4L	DILKR7H11GS	96964
2014-10	CR-V	L4 2.4L	ILZKR7B-11S	5787
2009-02	CR-V	L4 2.4L	IZFR6K11	6994
2016-11	CR-Z	L4 1.5L	DIFR6D13	94167
2011-03	ELEMENT	L4 2.4L	IZFR6K11	6994
2018-15	FIT	L4 1.5L	DILZKR7C11S	90137
2014-07	FIT	L4 1.5L	IZFR6K13	6774
2018-16	HR-V	L4 1.8L	DILZKR7B11GS	95710
2014-10	INSIGHT	L4 1.3L	DILFR6J11	92491
2017-11	ODYSSEY	V6 3.5L	DILZKR7A11G	92924
2018-18	ODYSSEY	V6 3.5L	DILZKR7B11G	95350
2010-08	ODYSSEY	V6 3.5L	ILZKR7B11	7751
2010-05	ODYSSEY	V6 3.5L	IZFR5K11	3657
2004-99	ODYSSEY	V6 3.5L	PZFR5F-11	4363
2002-97	PASSPORT	V6 3.2L	PFR5G-11	2647
2013-12	PILOT	V6 3.5L	DILZKR7A11DS	90074
2015-14	PILOT	V6 3.5L	DILZKR7A11G	92924
2017-16	PILOT	V6 3.5L	DILZKR7B11G	95350
2011-09	PILOT	V6 3.5L	ILZKR7B11	7751
2008-06	PILOT	V6 3.5L	IZFR5K11	3657

Note: Please refer to application section for detailed model listing



# Original Equipment Iridium and Platinum Spark Plugs

THE IGNITION SPECIALIST

YEAR	MODEL	ENGINE	NGK PART #	STOCK #
<b>HONDA</b>				
2005-03	PILOT	V6 3.5L	PZFR5F-11	4363
2001-94	PRELUDE	L4 2.2L	PZFR6F-11	3271
2018-17	RIDGELINE	V6 3.5L	DILZKR7B11G	95350
2014-09	RIDGELINE	V6 3.5L	ILZKR7B11	7751
2008-06	RIDGELINE	V6 3.5L	IZFR5K11	3657
2003-00	S2000	L4 2.0L	PFR7G-11S	7772
2009-04	S2000	L4 2.2L	PFR7G-11S	7772
<b>HUMMER</b>				
2006-06	H3	L5 3.5L	ILTR5B11	3474
2009-07	H3	L5 3.7L	ILTR5B11	3474
2010-10	H3	L5 3.7L	ILTR5E11	91418
2009-09	H3T	L5 3.7L	ILTR5B11	3474
2010-10	H3T	L5 3.7L	ILTR5E11	91418
<b>HYUNDAI</b>				
2017-12	ACCENT	L4 1.6L	SILZKR6B10E	93815
2011-07	AZERA	V6 3.3L	IFR5G11	7854
2017-12	AZERA	V6 3.3L	SILZKR7B11	9723
2011-06	AZERA	V6 3.8L	IFR5G11	7854
2013-13	ELANTRA COUPE	L4 1.8L	SILZKR7B11	9723
2014-14	ELANTRA COUPE	L4 2.0L	SILZKR7B11	9723
2013-13	ELANTRA GT	L4 1.8L	SILZKR7B11	9723
2015-14	ELANTRA GT	L4 2.0L	SILZKR7B11	9723
2011-11	ELANTRA	L4 1.8L	SILZKR6B11	6215
2016-12	ELANTRA	L4 1.8L	SILZKR7B11	9723
2003-03	ELANTRA	L4 2.0L	IFR5G11	7854
2012-07	ELANTRA	L4 2.0L	IZFR5L11	97932
2007-01	ELANTRA	L4 2.0L	PFR5N-11	5838
2015-14	ELANTRA	L4 2.0L	SILZKR7B11	9723
2010-07	ENTOURAGE	V6 3.8L	IFR5G11	7854
2011-11	EQUUS	V8 4.6L	DILFR5E11	92605
2016-12	EQUUS	V8 5.0L	DILKR7A11	93135
2016-10	GENESIS COUPE	V6 3.8L	SILZKR7B11	9723
2016-12	GENESIS	V6 3.8L	DILKR7A11	93135
2009-09	GENESIS	V6 3.8L	ILFR5B11	1637
2009-09	GENESIS	V6 3.8L	SILZKR6B11	6215
2012-09	GENESIS	V8 4.6L	DILFR5E11	92605
2016-12	GENESIS	V8 5.0L	DILKR7A11	93135
2018-13	SANTA FE XL	V6 3.3L	SILZKR7B11	9723
2006-01	SANTA FE	L4 2.4L	PGR5C-11	5760
2009-07	SANTA FE	V6 2.7L	ILFR5B11	1637
2006-01	SANTA FE	V6 2.7L	PFR5N-11	5838
2009-07	SANTA FE	V6 3.3L	IFR5G11	7854
2018-13	SANTA FE	V6 3.3L	SILZKR7B11	9723
2006-03	SANTA FE	V6 3.5L	PFR5N-11	5838
2012-10	SANTA FE	V6 3.5L	SILZKR7B11	9723
2015-15	SONATA	L4 2.0L	SILZKR7E9G	91467
2005-99	SONATA	L4 2.4L	PGR5C-11	5760
2018-15	SONATA	L4 2.4L	SILZKR7E11	92315
2001-99	SONATA	V6 2.5L	PFR5N-11	5838
2005-02	SONATA	V6 2.7L	PFR5N-11	5838
1998-90	SONATA	V6 3.0L	PGR5A-11	3573
2010-06	SONATA	V6 3.3L	IFR5G11	7854
2008-03	TIBURON	L4 2.0L	PFR5N-11	5838
2008-08	TIBURON	V6 2.7L	IFR5G11	7854
2007-03	TIBURON	V6 2.7L	PFR5N-11	5838
2009-05	TUCSON	L4 2.0L	PFR5N-11	5838
2017-14	TUCSON	L4 2.0L	SILZKR7B11	9723
2009-05	TUCSON	V6 2.7L	IFR5G11	7854
2017-12	VELOSTER	L4 1.6L	SILZKR6B10E	93815
2014-13	VELOSTER	L4 1.6L	SILZKR6D8E	91568
2015-14	VELOSTER	L4 1.6L	SILZKR7E8EG	93655
2012-07	VERACRUZ	V6 3.8L	IFR5G11	7854
<b>INFINITI</b>				
2008-03	FX35	V6 3.5L	PLFR5A-11	6240
2008-03	FX45	V8 4.5L	PLFR5A-11	6240
2002-99	G20	L4 2.0L	PFR5G-11	2647
1996-91	G20	L4 2.0L	PFR6B-11	4014
2007-03	G35	V6 3.5L	PLFR5A-11	6240
2001-96	I30	V6 3.0L	PFR5G-11	2647

YEAR	MODEL	ENGINE	NGK PART #	STOCK #
<b>INFINITI</b>				
2004-02	I35	V6 3.5L	PLFR5A-11	6240
1997-93	J30	V6 3.0L	PFR5G-11	2647
1992-90	M30	V6 3.0L	PFR6B-11	4014
2008-06	M35	V6 3.5L	PLFR5A-11	6240
2010-03	M45	V8 4.5L	PLFR5A-11	6240
2013-11	M56	V8 5.6L	DILKAR7B11	1406
2001-97	Q45	V8 4.1L	PFR5G-11	2647
1993-90	Q45	V8 4.5L	PFR5B-11	2300
1996-94	Q45	V8 4.5L	PFR5G-11	2647
2006-02	Q45	V8 4.5L	PLFR5A-11	6240
2017-16	Q50	L4 2.0L	SILZKFR8E7S	90654
2017-14	Q70	V8 5.6L	DILKAR7B11	1406
2017-15	Q70L	V8 5.6L	DILKAR7B11	1406
2000-98	QX4	V6 3.3L	FR5AP-10	6371
2003-01	QX4	V6 3.5L	PLFR5A-11	6240
2010-07	QX56	V8 5.6L	DILFR5A11	93759
2013-11	QX56	V8 5.6L	DILKAR7B11	1406
2006-04	QX56	V8 5.6L	PLFR5A-11	6240
2016-14	QX60	L4 2.5L	DILKAR7C9H	91215
2017-14	QX80	V8 5.6L	DILKAR7B11	1406
<b>ISUZU</b>				
2003-02	AXIOM	V6 3.5L	PFR5G-11	2647
2006-06	I-280	L4 2.8L	ILTR5B11	3474
2008-07	I-290	L4 2.9L	ILTR5B11	3474
2008-08	I-370	L5 3.7L	ILTR5B11	3474
2007-07	I-370	L5 3.7L	ILTR5E11	91418
2003-02	RODEO SPORT	V6 3.2L	PFR5G-11	2647
2004-96	RODEO	V6 3.2L	PFR5G-11	2647
1997-96	TROOPER	V6 3.2L	PFR5G-11	2647
2002-98	TROOPER	V6 3.5L	PFR5G-11	2647
2001-99	VEHICROSS	V6 3.5L	PFR5G-11	2647
<b>JAGUAR</b>				
2017-17	F-PACE	V6 3.0L	SILZKAR7E8S	93476
2017-14	F-TYPE	V6 3.0L	SILZKAR7E8S	93476
2017-14	F-TYPE	V8 5.0L	ILKAR7C10	94940
2008-00	S-TYPE	V6 3.0L	TR6AP-13E	4968
2002-00	S-TYPE	V8 4.0L	PFR5G-13E	2761
2008-07	S-TYPE	V8 4.2L	IFR5N10	7866
2009-06	SUPER V8	V8 4.2L	IFR5N10	7866
1997-97	VANDEN PLAS	L6 4.0L	PFR5G-13E	2761
2002-00	VANDEN PLAS	V8 4.0L	IFR5N10	7866
2003-98	VANDEN PLAS	V8 4.0L	PFR5G-13E	2761
2003-03	VANDEN PLAS	V8 4.0L	PFR6G-13E	2341
2009-06	VANDEN PLAS	V8 4.2L	IFR5N10	7866
2017-17	XE	L4 2.0L	ILTR6G8G	96621
2017-17	XE	V6 3.0L	SILZKAR7E8S	93476
2015-13	XF	L4 2.0L	ILTR6G8G	96621
2017-13	XF	V6 3.0L	SILZKAR7E8S	93476
2010-09	XF	V8 4.2L	IFR5N10	7866
2015-10	XF	V8 5.0L	ILKAR7C10	94940
2015-10	XFR	V8 5.0L	ILKAR7C10	94940
2015-13	XFR-S	V8 5.0L	ILKAR7C10	94940
2016-13	XJ	V6 3.0L	SILZKAR7E8S	93476
2016-10	XJ	V8 5.0L	ILKAR7C10	94940
2002-00	XJ8	V8 4.0L	IFR5N10	7866
2003-98	XJ8	V8 4.0L	PFR5G-13E	2761
2009-08	XJ8	V8 4.2L	IFR5N10	7866
2003-98	XJR	V8 4.0L	PFR6G-13E	2341
2009-07	XJR	V8 4.2L	IFR5N10	7866
2016-14	XJR	V8 5.0L	ILKAR7C10	94940
2009-07	XK	V8 4.2L	IFR5N10	7866
2015-10	XK	V8 5.0L	ILKAR7C10	94940
2002-00	XK8	V8 4.0L	IFR5N10	7866
1999-97	XK8	V8 4.0L	PFR5G-13E	2761
2002-00	XKR	V8 4.0L	IFR5N10	7866
2009-07	XKR	V8 4.2L	IFR5N10	7866
2003-03	XKR	V8 4.2L	PFR6G-13E	2341
2015-10	XKR	V8 5.0L	ILKAR7C10	94940
2015-12	XKR-S	V8 5.0L	ILKAR7C10	94940
2008-02	X-TYPE	V6 3.0L	TR6AP-13E	4968

Note: Please refer to application section for detailed model listing



## Original Equipment Iridium and Platinum Spark Plugs

YEAR	MODEL	ENGINE	NGK PART #	STOCK #
<b>JEEP</b>				
2009-09	COMPASS	L4 2.4L	ZFR5AP	92041
2017-14	GRAND CHEROKEE	V8 5.7L	LZFR5CI-11	92145
2010-06	GRAND CHEROKEE	V8 6.1L	PLZTR5A-13	4998
2017-12	GRAND CHEROKEE	V8 6.4L	LZTR6AP11EG	97408
2009-09	PATRIOT	L4 2.4L	ZFR5AP	92041
2017-15	RENEGADE	L4 1.4L	SIKR9A7	93618
<b>KIA</b>				
2006-04	AMANTI	V6 3.5L	PFR5N-11	5838
2009-07	AMANTI	V6 3.8L	IFR5G11	7854
2009-09	BORREGO	V6 3.8L	ILFR5B11	1637
2011-09	BORREGO	V6 3.8L	SILZKR6B11	6215
2011-09	BORREGO	V8 4.6L	DILFR5E11	92605
2017-14	CADENZA	V6 3.3L	SILZKR7B11	9723
2016-14	FORTE KOUP	L4 1.6L	SILZKR6D8E	91568
2016-14	FORTE KOUP	L4 1.6L	SILZKR7E8EG	93655
2016-14	FORTE KOUP	L4 2.0L	SILZKR7B11	9723
2016-14	FORTE	L4 1.8L	SILZKR7B11	9723
2017-14	FORTE	L4 2.0L	SILZKR7B11	9723
2016-14	FORTE5	L4 1.6L	SILZKR6D8E	91568
2016-14	FORTE5	L4 1.6L	SILZKR7E8EG	93655
2017-14	FORTE5	L4 2.0L	SILZKR7B11	9723
2017-15	K900	V6 3.8L	DILKR7A11	93135
2017-15	K900	V8 5.0L	DILKR7A11	93135
2006-01	MAGENTIS	L4 2.4L	PGR5C-11	5760
2001-01	MAGENTIS	V6 2.5L	PFR5N-11	5838
2010-07	MAGENTIS	V6 2.7L	ILFR5B11	1637
2006-02	MAGENTIS	V6 2.7L	PFR5N-11	5838
2006-01	OPTIMA	L4 2.4L	PGR5C-11	5760
2017-16	OPTIMA	L4 2.4L	SILZKR7E11	92315
2001-01	OPTIMA	V6 2.5L	PFR5N-11	5838
2010-06	OPTIMA	V6 2.7L	ILFR5B11	1637
2006-02	OPTIMA	V6 2.7L	PFR5N-11	5838
2017-12	RIO	L4 1.6L	SILZKR6B10E	93815
2017-14	RONDO	L4 2.0L	SILZKR7B11	9723
2012-07	RONDO	V6 2.7L	ILFR5B11	1637
2017-15	SEDONA	V6 3.3L	SILZKR7B11	9723
2014-11	SEDONA	V6 3.5L	IFR5G11	7854
2005-02	SEDONA	V6 3.5L	PFR5N-11	5838
2014-11	SEDONA	V6 3.5L	SILZKR7B11	9723
2010-06	SEDONA	V6 3.8L	IFR5G11	7854
2016-16	SORENTO	L4 2.0L	SILZKR7E9G	91467
2017-15	SORENTO	L4 2.4L	SILZKR7E11	92315
2009-08	SORENTO	V6 3.3L	IFR5G11	7854
2017-14	SORENTO	V6 3.3L	SILZKR7B11	9723
2006-03	SORENTO	V6 3.5L	PFR5N-11	5838
2013-11	SORENTO	V6 3.5L	SILZKR7B11	9723
2009-07	SORENTO	V6 3.8L	IFR5G11	7854
2017-12	SOUL	L4 1.6L	SILZKR6B10E	93815
2011-10	SOUL	L4 2.0L	IZFR5L11	97932
2017-12	SOUL	L4 2.0L	SILZKR7B11	9723
2009-08	SPECTRA	L4 2.0L	IZFR5L11	97932
2007-04	SPECTRA	L4 2.0L	PFR5N-11	5838
2009-08	SPECTRA5	L4 2.0L	IZFR5L11	97932
2007-05	SPECTRA5	L4 2.0L	PFR5N-11	5838
2010-05	SPORTAGE	L4 2.0L	PFR5N-11	5838
2017-16	SPORTAGE	L4 2.4L	SILZKR7E11	92315
2010-05	SPORTAGE	V6 2.7L	IFR5G11	7854
<b>LAND ROVER</b>				
2016-15	DISCOVERY SPORT	L4 2.0L	ILTR6G8G	96621
2015-13	LR2	L4 2.0L	ILTR6G8G	96621
2012-08	LR2	L6 3.2L	ILFR6B	6481
2009-05	LR3	V8 4.4L	IFR5N10	7866
2016-14	LR4	V6 3.0L	SILZKAR7E8S	93476
2013-10	LR4	V8 5.0L	ILKAR7C10	94940
2016-12	RANGE ROVER EVOQUE	L4 2.0L	ILTR6G8G	96621
2016-14	RANGE ROVER SPORT	V6 3.0L	SILZKAR7E8S	93476
2009-06	RANGE ROVER SPORT	V8 4.2L	IFR5N10	7866

YEAR	MODEL	ENGINE	NGK PART #	STOCK #
<b>LAND ROVER</b>				
2009-06	RANGE ROVER SPORT	V8 4.4L	IFR5N10	7866
2016-10	RANGE ROVER SPORT	V8 5.0L	ILKAR7C10	94940
2016-14	RANGE ROVER	V6 3.0L	SILZKAR7E8S	93476
2009-06	RANGE ROVER	V8 4.2L	IFR5N10	7866
2005-03	RANGE ROVER	V8 4.4L	BKR6EQUP	3199
2009-06	RANGE ROVER	V8 4.4L	IFR5N10	7866
2016-10	RANGE ROVER	V8 5.0L	ILKAR7C10	94940
<b>LEXUS</b>				
1991-90	ES250	V6 2.5L	BCPR6EP-11	3350
1993-92	ES300	V6 3.0L	BCPR6EP-11	3350
1998-96	ES300	V6 3.0L	BKR6EKP-11	3452
1995-94	ES300	V6 3.0L	BKR6EP-11	2978
2003-99	ES300	V6 3.0L	IFR6T11	4589
2017-17	GS TURBO	L4 2.0L	DILFR7K9G	91961
2016-16	GS200T	L4 2.0L	DILFR7K9G	91961
2000-98	GS300	L6 3.0L	BKR5EKP-11	4302
1997-94	GS300	L6 3.0L	BKR5EP-11	3440
2005-93	GS300	L6 3.0L	BKR6EP-11	2978
2002-01	GS300	L6 3.0L	IFR6T11	4589
2000-98	GS400	V8 4.0L	IFR6T11	4589
2005-01	GS430	V8 4.3L	IFR6T11	4589
2017-17	IS TURBO	L4 2.0L	DILFR7K9G	91961
2016-16	IS200T	L4 2.0L	DILFR7K9G	91961
2005-01	IS300	L6 3.0L	IFR6T11	4589
1997-90	LS400	V8 4.0L	BKR6EP-11	2978
2000-98	LS400	V8 4.0L	IFR6T11	4589
2005-01	LS430	V8 4.3L	IFR6T11	4589
2002-98	LX470	V8 4.7L	IFR6T11	4589
2017-15	NX200T	L4 2.0L	DILFR7K9G	91961
2017-17	RC TURBO	L4 2.0L	DILFR7K9G	91961
2016-16	RC200T	L4 2.0L	DILFR7K9G	91961
2003-99	RX300	V6 3.0L	IFR6T11	4589
2000-99	SC300	L6 3.0L	BKR5EKP-11	4302
1998-92	SC300	L6 3.0L	BKR5EP-11	3440
1994-93	SC300	L6 3.0L	BKR6EP-11	2978
1997-92	SC400	V8 4.0L	BKR6EP-11	2978
2000-98	SC400	V8 4.0L	IFR6T11	4589
<b>LINCOLN</b>				
2017-17	CONTINENTAL	V6 2.7L	ILTR7N8	95822
2017-17	CONTINENTAL	V6 3.0L	ILTR7N8	95822
2017-17	CONTINENTAL	V6 3.7L	LTR6BP13	94806
2006-03	LS	V8 3.9L	FR5AP-11E	6569
2008-08	MARK LT	V8 5.4L	PZNR6A11H	5507
2017-15	MKC	L4 2.0L	LTR6DI-8	96588
2017-15	MKC	L4 2.3L	LTR6DI-8	96588
2016-10	MKS	V6 3.5L	LTR6CI-8	97177
2013-09	MKS	V6 3.7L	ILTR5K13	90607
2016-14	MKS	V6 3.7L	LTR6BP13	94806
2016-13	MKT	L4 2.0L	LTR6DI-8	96588
2017-10	MKT	V6 3.5L	LTR6CI-8	97177
2012-10	MKT	V6 3.7L	ILTR5K13	90607
2017-12	MKT	V6 3.7L	LTR6BP13	94806
2017-16	MKX	V6 2.7L	ILTR7N8	95822
2010-07	MKX	V6 3.5L	ILTR5K13	90607
2017-11	MKX	V6 3.7L	LTR6BP13	94806
2017-13	MKZ	L4 2.0L	ILTR5K13	90607
2017-13	MKZ	L4 2.0L	LTR6DI-8	96588
2012-11	MKZ	L4 2.5L	ILTR5K13	90607
2017-17	MKZ	V6 3.0L	ILTR7N8	95822
2012-07	MKZ	V6 3.5L	ILTR5K13	90607
2016-13	MKZ	V6 3.7L	LTR6BP13	94806
2017-15	NAVIGATOR	V6 3.5L	LTR6CI-8	97177
2014-08	NAVIGATOR	V8 5.4L	PZNR6A11H	5507
<b>LOTUS</b>				
2006-06	ELISE	L4 1.8L	PFR6N-11	3546
2006-06	EXIGE	L4 1.8L	PFR6N-11	3546

Note: Please refer to application section for detailed model listing



# Original Equipment Iridium and Platinum Spark Plugs

THE IGNITION SPECIALIST

YEAR	MODEL	ENGINE	NGK PART #	STOCK #
<b>MASERATI</b>				
2006-05	COUPE	V8 4.2L	PMR8B	6378
2006-05	GRANSPORT	V8 4.2L	PMR8B	6378
2011-08	GRANTURISMO	V8 4.2L	PMR8C-H	96361
2011-09	GRANTURISMO	V8 4.7L	PMR8C-H	96361
2007-04	QUATTROPORTE	V8 4.2L	PMR8B	6378
2011-07	QUATTROPORTE	V8 4.2L	PMR8C-H	96361
2011-09	QUATTROPORTE	V8 4.7L	PMR8C-H	96361
2006-05	SPYDER	V8 4.2L	PMR8B	6378
<b>MAYBACH</b>				
2012-03	57	V12 5.5L	IFR6Q-G	5648
2012-06	57	V12 6.0L	IFR6Q-G	5648
2012-03	62	V12 5.5L	IFR6Q-G	5648
2012-07	62	V12 6.0L	IFR6Q-G	5648
<b>MAZDA</b>				
2016-12	3 SPORT	L4 2.0L	ILKAR7L11	94124
2013-09	3 SPORT	L4 2.0L	LTR5BI-13	90083
2016-14	3 SPORT	L4 2.5L	ILKAR7L11	94124
2013-10	3 SPORT	L4 2.5L	LTR5BI-13	90083
2016-12	3	L4 2.0L	ILKAR7L11	94124
2005-04	3	L4 2.0L	ITR6F13	4477
2013-06	3	L4 2.0L	LTR5BI-13	90083
2009-07	3	L4 2.3L	ILTR6A-8G	3787
2005-04	3	L4 2.3L	ITR6F13	4477
2009-06	3	L4 2.3L	LTR5BI-13	90083
2013-10	3	L4 2.3L	SILTR6A7G	95369
2016-14	3	L4 2.5L	ILKAR7L11	94124
2013-10	3	L4 2.5L	LTR5BI-13	90083
2010-08	5	L4 2.3L	LTR5BI-13	90083
2007-06	5	L4 2.3L	TR5AI-13	90813
2015-12	5	L4 2.5L	LTR5BI-13	90083
2007-06	6	L4 2.3L	ILTR6A-8G	3787
2008-06	6	L4 2.3L	LTR5BI-13	90083
2005-03	6	L4 2.3L	TR5AI-13	90813
2017-14	6	L4 2.5L	ILKAR7L11	94124
2013-09	6	L4 2.5L	LTR5BI-13	90083
2010-01	B2300	L4 2.3L	PTR5F-11	6579
2017-16	CX-3	L4 2.0L	ILKAR7L11	94124
2016-13	CX-5	L4 2.0L	ILKAR7L11	94124
2016-14	CX-5	L4 2.5L	ILKAR7L11	94124
2009-07	CX-7	L4 2.3L	ILTR6A-8G	3787
2012-10	CX-7	L4 2.3L	SILTR6A7G	95369
2012-10	CX-7	L4 2.5L	LTR5BI-13	90083
2005-04	MIATA	L4 1.8L	IFR5T-8N	3508
2002-95	MILLENNIA	V6 2.3L	PZFR5F	3741
2017-16	MX-5 MIATA	L4 2.0L	ILKAR7L11	94124
2015-06	MX-5 MIATA	L4 2.0L	LTR6BI-13	91725
2003-03	PROTEGE	L4 2.0L	PZFR6F-11	3271
1995-93	RX-7	R2 1.3L	BUR7EQP	4764
1995-93	RX-7	R2 1.3L	BUR9EQP	5255
2011-04	RX-8	R2 1.3L	RE7C-L	6700
2011-04	RX-8	R2 1.3L	RE9B-T	6701
2008-05	TRIBUTE	L4 2.3L	TR5AI-13	90813
2011-09	TRIBUTE	L4 2.5L	LTR5BI-13	90083
2008-01	TRIBUTE	V6 3.0L	TR5AI-13	90813
2011-09	TRIBUTE	V6 3.0L	TR5BP12	93858
<b>MERCEDES-BENZ</b>				
2014-14	B250	L4 2.0L	SILZKFR8D7S	95875
2017-13	B250	L4 2.0L	SILZKFR8E7S	90654
2002-02	C230	L4 2.3L	IFR6D10	5344
2009-06	C230	V6 2.5L	PLKR7A	4288
2002-01	C240	V6 2.6L	PFR5R-11	4292
2015-12	C250	L4 1.8L	PLKR7B8E	94716
2000-99	C280	V6 2.8L	PFR5R-11	4292
2017-15	C300	L4 2.0L	SILZKFR8E7S	90654
2004-02	C32 AMG	V6 3.2L	IFR6D10	5344
2002-01	C320	V6 3.2L	PFR5R-11	4292
2017-16	C350E	L4 2.0L	SILZKFR8E7S	90654
2015-15	C400	V6 3.0L	SILZKFR8D7S	95875
2017-17	C43 AMG	V6 3.0L	SILZKFR8D7S	95875

YEAR	MODEL	ENGINE	NGK PART #	STOCK #
<b>MERCEDES-BENZ</b>				
2000-98	C43 AMG	V8 4.3L	PFR5R-11	4292
2016-16	C450 AMG	V6 3.0L	SILZKFR8D7S	95875
2006-05	C55 AMG	V8 5.5L	IFR6D10	5344
2015-08	C63 AMG	V8 6.3L	ILZKAR7A10	6043
2002-00	CL500	V8 5.0L	PFR5R-11	4292
2006-03	CL55 AMG	V8 5.5L	ILFR6A	3588
2002-01	CL55 AMG	V8 5.5L	PFR5R-11	4292
2010-07	CL550	V8 5.5L	PLKR7A	4288
2014-03	CL600	V12 5.5L	IFR6Q-G	5648
2001-01	CL600	V12 5.8L	PFR5R-11	4292
2010-08	CL63 AMG	V8 6.3L	ILZKAR7A10	6043
2014-05	CL65 AMG	V12 6.0L	IFR6Q-G	5648
2017-14	CLA250	L4 2.0L	SILZKFR8E7S	90654
2017-14	CLA45 AMG	L4 2.0L	SILZKFR8D7S	95875
2002-98	CLK320	V6 3.2L	PFR5R-11	4292
2002-99	CLK430	V8 4.3L	PFR5R-11	4292
2006-03	CLK55 AMG	V8 5.5L	IFR6D10	5344
2002-01	CLK55 AMG	V8 5.5L	PFR5R-11	4292
2009-07	CLK550	V8 5.5L	PLKR7A	4288
2009-07	CLK63 AMG	V8 6.3L	ILZKAR7A10	6043
2016-15	CLS400	V6 3.0L	SILZKFR8D7S	95875
2006-06	CLS55 AMG	V8 5.5L	ILFR6A	3588
2011-07	CLS550	V8 5.5L	PLKR7A	4288
2011-07	CLS63 AMG	V8 6.3L	ILZKAR7A10	6043
2017-17	E300	L4 2.0L	SILZKFR8E7S	90654
2002-98	E320	V6 3.2L	PFR5R-11	4292
2017-15	E400	V6 3.0L	SILZKFR8D7S	95875
2017-17	E43 AMG	V6 3.0L	SILZKFR8D7S	95875
2002-98	E430	V8 4.3L	PFR5R-11	4292
2006-03	E55 AMG	V8 5.5L	ILFR6A	3588
2002-99	E55 AMG	V8 5.5L	PFR5R-11	4292
2011-07	E550	V8 5.5L	PLKR7A	4288
2011-07	E63 AMG	V8 6.3L	ILZKAR7A10	6043
2002-02	G500	V8 5.0L	PFR5R-11	4292
2011-05	G55 AMG	V8 5.5L	ILFR6A	3588
2017-16	G550	V8 4.0L	SILZKFR8D7S	95875
2015-09	G550	V8 5.5L	PLKR7A	4288
2017-16	G65 AMG	V12 6.0L	IFR6Q-G	5648
2016-15	GL450	V6 3.0L	SILZKFR8D7S	95875
2012-07	GL450	V8 4.6L	PLKR7A	4288
2012-08	GL550	V8 5.5L	PLKR7A	4288
2017-15	GLA250	L4 2.0L	SILZKFR8E7S	90654
2017-15	GLA45 AMG	L4 2.0L	SILZKFR8D7S	95875
2017-16	GLC300	L4 2.0L	SILZKFR8E7S	90654
2017-17	GLC43 AMG	V6 3.0L	SILZKFR8D7S	95875
2017-16	GLE400	V6 3.0L	SILZKFR8D7S	95875
2017-17	GLE43 AMG	V6 3.0L	SILZKFR8D7S	95875
2016-16	GLE450 AMG	V6 3.0L	SILZKFR8D7S	95875
2017-16	GLE550E	V6 3.0L	SILZKFR8D7S	95875
2017-17	GLS450	V6 3.0L	SILZKFR8D7S	95875
2017-16	MAYBACH S600	V12 6.0L	IFR6Q-G	5648
2017-16	METRIS	L4 2.0L	SILZKFR8E7S	90654
2002-98	ML230	V6 3.2L	PFR5R-11	4292
2005-03	ML350	V6 3.7L	PFR5R-11	4292
2015-15	ML400	V6 3.0L	SILZKFR8D7S	95875
2001-99	ML430	V8 4.3L	PFR5R-11	4292
2002-02	ML500	V8 5.0L	PFR5R-11	4292
2006-05	ML500	V8 5.0L	PLKR7A	4288
2002-00	ML55 AMG	V8 5.5L	PFR5R-11	4292
2011-08	ML550	V8 5.5L	PLKR7A	4288
2011-07	ML63 AMG	V8 6.3L	ILZKAR7A10	6043
2007-07	R63 AMG	V8 6.3L	ILZKAR7A10	6043
2002-00	S430	V8 4.3L	PFR5R-11	4292
2011-08	S450	V8 4.6L	PLKR7A	4288
2006-03	S55 AMG	V8 5.5L	ILFR6A	3588
2002-01	S55 AMG	V8 5.5L	PFR5R-11	4292
2011-07	S550	V8 5.5L	PLKR7A	4288
2017-15	S550E	V6 3.0L	SILZKFR8D7S	95875
2013-03	S600	V12 5.5L	IFR6Q-G	5648

Note: Please refer to application section for detailed model listing

## Original Equipment Iridium and Platinum Spark Plugs

YEAR	MODEL	ENGINE	NGK PART #	STOCK #
<b>MERCEDES-BENZ</b>				
2001-01	S600	V12 5.8L	PFR5R-11	4292
2017-15	S600	V12 6.0L	IFR6Q-G	5648
2010-08	S63 AMG	V8 6.3L	ILZKAR7A10	6043
2017-06	S65 AMG	V12 6.0L	IFR6Q-G	5648
2016-15	SL400	V6 3.0L	SILZKFR8D7S	95875
2017-17	SL450	V6 3.0L	SILZKFR8D7S	95875
2002-01	SL500	V8 5.0L	PFR5R-11	4292
2008-03	SL55 AMG	V8 5.5L	ILFR6A	3588
2012-07	SL550	V8 5.5L	PLKR7A	4288
2011-04	SL600	V12 5.5L	IFR6Q-G	5648
2012-09	SL63 AMG	V8 6.3L	ILZKAR7A10	6043
2017-05	SL65 AMG	V12 6.0L	IFR6Q-G	5648
2017-17	SLC300	L4 2.0L	SILZKFR8E7S	90654
2017-17	SLC43 AMG	V6 3.0L	SILZKFR8D7S	95875
2004-01	SLK230	L4 2.3L	IFR6D10	5344
2015-12	SLK250	L4 1.8L	PLKR7B8E	94716
2016-16	SLK300	L4 2.0L	SILZKFR8E7S	90654
2004-02	SLK32 AMG	V6 3.2L	IFR6D10	5344
2002-01	SLK320	V6 3.2L	PFR5R-11	4292
2011-05	SLK55 AMG	V8 5.5L	IFR6D10	5344
2009-05	SLR MCLAREN	V8 5.5L	ILFR6A	3588
<b>MERCURY</b>				
2008-05	MARINER	L4 2.3L	ITR5H13	97287
2011-09	MARINER	L4 2.5L	ILTR5K13	90607
2009-09	MARINER	V6 3.0L	TR5BP12	93858
2009-06	MILAN	L4 2.3L	ILTR5K13	90607
2011-10	MILAN	L4 2.5L	ILTR5K13	90607
2010-10	MILAN	V6 3.0L	TR5BP12	93858
2010-08	MOUNTAINEER	V8 4.6L	PZNR6A11H	5507
2009-08	SABLE	V6 3.5L	ILTR5K13	90607
2002-99	VILLAGER	V6 3.3L	PFR5G-11	2647
<b>MINI</b>				
2017-16	COOPER CLUBMAN	L3 1.5L	SILZKGR8B8S	94201
2017-16	COOPER CLUBMAN	L4 2.0L	SILZKGR8B8S	94201
2017-17	COOPER COUNTRY-MAN	L3 1.5L	SILZKGR8B8S	94201
2017-17	COOPER COUNTRY-MAN	L4 2.0L	SILZKGR8B8S	94201
2017-14	COOPER	L3 1.5L	SILZKGR8B8S	94201
2008-02	COOPER	L4 1.6L	BKR6EQUP	3199
2012-07	COOPER	L4 1.6L	ILZKBR7B8DG	95770
2017-14	COOPER	L4 2.0L	SILZKGR8B8S	94201
<b>MITSUBISHI</b>				
1999-91	3000GT	V6 3.0L	PFR6J-11	2743
1995-92	DIAMANTE	V6 3.0L	PFR6J-11	2743
2012-06	ECLIPSE	L4 2.4L	LZFR6AI	3656
2005-04	ECLIPSE	V6 3.0L	FR5EI	1313
2005-04	ECLIPSE	V6 3.0L	FR6EI	2687
2003-03	ECLIPSE	V6 3.0L	IFR6B	6507
2003-01	ECLIPSE	V6 3.0L	PFR5G-11	2647
2000-00	ECLIPSE	V6 3.0L	PFR6G-11	5555
2012-06	ECLIPSE	V6 3.8L	IFR6B-K	4867
2011-04	ENDEAVOR	V6 3.8L	FR6EI	2687
2012-04	GALANT	L4 2.4L	LZFR6AI	3656
2003-01	GALANT	V6 3.0L	PFR5G-11	2647
2000-99	GALANT	V6 3.0L	PFR6G-11	5555
1988-88	GALANT	V6 3.0L	PGR5A-11	3573
2009-04	GALANT	V6 3.8L	FR6EI	2687
2009-07	GALANT	V6 3.8L	IFR6B-K	4867
2017-11	LANCER	L4 2.0L	DIFR6C11	1312
2015-11	LANCER	L4 2.0L	DILKR7B6	96957
2015-11	LANCER	L4 2.0L	DILKR8B6	91448
2010-08	LANCER	L4 2.0L	FR6EI	2687
2005-03	LANCER	L4 2.0L	IGR7A-G	3106
2006-06	LANCER	L4 2.0L	ILFR7H	5245
2010-09	LANCER	L4 2.0L	ILKR7E6	93053
2010-08	LANCER	L4 2.0L	ILKR8E6	1422
2017-11	LANCER	L4 2.4L	DIFR5C11	1311
2010-09	LANCER	L4 2.4L	FR5EI	1313
2006-04	LANCER	L4 2.4L	LZFR6AI	3656

YEAR	MODEL	ENGINE	NGK PART #	STOCK #
<b>MITSUBISHI</b>				
2015-14	MIRAGE	L3 1.2L	LZFR5BI-11	93298
2003-99	MONTERO SPORT	V6 3.0L	IFR5E11	7994
1998-97	MONTERO SPORT	V6 3.0L	PFR6J-11	2743
1996-95	MONTERO	V6 3.0L	PFR6J-11	2743
1996-94	MONTERO	V6 3.5L	PFR5J-11	4642
2006-03	MONTERO	V6 3.8L	IFR6B	6507
2017-11	OUTLANDER SPORT	L4 2.0L	DIFR6C11	1312
2017-15	OUTLANDER SPORT	L4 2.4L	DIFR5C11	1311
2013-11	OUTLANDER	L4 2.4L	DIFR5C11	1311
2017-14	OUTLANDER	L4 2.4L	DILKR6D11G	95264
2010-08	OUTLANDER	L4 2.4L	FR5EI	1313
2006-04	OUTLANDER	L4 2.4L	LZFR6AI	3656
2017-14	OUTLANDER	V6 3.0L	DILKR7C11	94731
2013-07	OUTLANDER	V6 3.0L	ILKR7B8	1989
2017-11	RVR	L4 2.0L	DIFR6C11	1312
2017-15	RVR	L4 2.4L	DIFR5C11	1311
1990-89	SIGMA	V6 3.0L	PGR5A-11	3573
<b>NISSAN</b>				
1998-95	200SX	L4 2.0L	PFR6B-11	4014
1998-94	240SX	L4 2.4L	PFR5C-11	2271
1996-90	300ZX	V6 3.0L	PFR5B-11	2300
1996-90	300ZX	V6 3.0L	PFR5B-11B	2867
2006-03	350Z	V6 3.5L	PLFR5A-11	6240
1999-99	ALTIMA	L4 2.4L	FR5AP-10	6371
2001-00	ALTIMA	L4 2.4L	PFR5G-11	2647
2013-07	ALTIMA	L4 2.5L	DILKAR6A11	9029
2006-02	ALTIMA	L4 2.5L	PLFR5A-11	6240
2006-02	ALTIMA	V6 3.5L	PLFR5A-11	6240
2015-07	ARMADA	V8 5.6L	DILFR5A11	93759
2015-07	ARMADA	V8 5.6L	DILFR5A-11D	98376
2017-17	ARMADA	V8 5.6L	DILKAR7B11	1406
2006-05	ARMADA	V8 5.6L	PLFR5A-11	6240
2000-99	FRONTIER	L4 2.4L	FR5AP-10	6371
2004-01	FRONTIER	L4 2.4L	PFR5G-11	2647
2017-05	FRONTIER	L4 2.5L	PLZKAR6A-11	5118
2000-99	FRONTIER	V6 3.3L	FR5AP-10	6371
2004-01	FRONTIER	V6 3.3L	PFR5G-11	2647
2004-01	FRONTIER	V6 3.3L	PFR6G-11	5555
2017-07	FRONTIER	V6 4.0L	DILFR5A11	93759
2017-17	FRONTIER	V6 4.0L	DILFR5A-11D	98376
2006-05	FRONTIER	V6 4.0L	PLFR5A-11	6240
2017-09	GT-R	V6 3.8L	DILKAR8A8	93026
2017-11	JUKE	L4 1.6L	DILKAR7C9H	91215
1994-92	MAXIMA	V6 3.0L	PFR5C-11	2271
2001-95	MAXIMA	V6 3.0L	PFR5G-11	2647
2008-02	MAXIMA	V6 3.5L	PLFR5A-11	6240
2016-16	MURANO	L4 2.5L	DILKAR7C9H	91215
2007-03	MURANO	V6 3.5L	PLFR5A-11	6240
2017-12	NV1500	V6 4.0L	DILFR5A11	93759
2017-12	NV2500	V6 4.0L	DILFR5A11	93759
2017-12	NV2500	V8 5.6L	DILFR5A11	93759
2018-18	NV2500	V8 5.6L	DILKAR7B11	1406
2017-12	NV3500	V6 4.0L	DILFR5A11	93759
2017-12	NV3500	V8 5.6L	DILFR5A11	93759
2018-18	NV3500	V8 5.6L	DILKAR7B11	1406
1993-91	NX	L4 2.0L	PFR6B-11	4014
2004-04	PATHFINDER ARMADA	V8 5.6L	PLFR5A-11	6240
2014-14	PATHFINDER	L4 2.5L	DILKAR7C9H	91215
2000-98	PATHFINDER	V6 3.3L	FR5AP-10	6371
2004-01	PATHFINDER	V6 3.5L	PLFR5A-11	6240
2012-07	PATHFINDER	V6 4.0L	DILFR5A11	93759
2006-05	PATHFINDER	V6 4.0L	PLFR5A-11	6240
2012-08	PATHFINDER	V8 5.6L	DILFR5A11	93759
1987-87	PULSAR NX	L4 1.6L	PFR6A-11	4045
1989-88	PULSAR NX	L4 1.8L	PFR6A-11	4045
2000-99	QUEST	V6 3.3L	FR5AP-10	6371
2002-01	QUEST	V6 3.3L	PFR5G-11	2647
2009-04	QUEST	V6 3.5L	PLFR5A-11	6240

Note: Please refer to application section for detailed model listing



# Original Equipment Iridium and Platinum Spark Plugs

THE IGNITION SPECIALIST

YEAR	MODEL	ENGINE	NGK PART #	STOCK #
<b>NISSAN</b>				
2015-14	ROGUE SELECT	L4 2.5L	DILKAR6A11	9029
2013-08	ROGUE	L4 2.5L	DILKAR6A11	9029
2017-13	SENTRA	L4 1.8L	DILKAR6A11	9029
2006-00	SENTRA	L4 1.8L	PLFR5A-11	6240
2017-13	SENTRA	L4 1.8L	PLZKAR6A-11	5118
2001-00	SENTRA	L4 2.0L	PFR5G-11	2647
1999-91	SENTRA	L4 2.0L	PFR6B-11	4014
2010-07	SENTRA	L4 2.0L	PLZKAR6A-11	5118
2012-07	SENTRA	L4 2.5L	DILKAR6A11	9029
2006-02	SENTRA	L4 2.5L	PLFR5A-11	6240
2017-16	TITAN XD	V8 5.6L	DILKAR7B11	1406
2015-07	TITAN	V8 5.6L	DILFR5A11	93759
2015-07	TITAN	V8 5.6L	DILFR5A-11D	98376
2017-17	TITAN	V8 5.6L	DILKAR7B11	1406
2006-04	TITAN	V8 5.6L	PLFR5A-11	6240
2011-09	VERSA	L4 1.6L	DILKAR6A11	9029
2000-00	XTERRA	L4 2.4L	FR5AP-10	6371
2004-01	XTERRA	L4 2.4L	PFR5G-11	2647
2000-00	XTERRA	V6 3.3L	FR5AP-10	6371
2004-01	XTERRA	V6 3.3L	PFR5G-11	2647
2004-02	XTERRA	V6 3.3L	PFR6G-11	5555
2015-07	XTERRA	V6 4.0L	DILFR5A11	93759
2006-05	XTERRA	V6 4.0L	PLFR5A-11	6240
2006-05	X-TRAIL	L4 2.5L	PLFR5A-11	6240
<b>OLDSMOBILE</b>				
1999-94	88	V6 3.8L	ITR4A15	5599
1996-94	98	V6 3.8L	ITR4A15	5599
2004-02	ALERO	L4 2.2L	ILTR5C11	5581
2004-02	ALERO	V6 3.4L	ITR4A15	5599
2002-01	AURORA	V6 3.5L	PTR5C-13	7740
2002-99	INTRIGUE	V6 3.5L	PTR5C-13	7740
1999-98	INTRIGUE	V6 3.8L	ITR4A15	5599
1999-96	LSS	V6 3.8L	ITR4A15	5599
1998-97	REGENCY	V6 3.8L	ITR4A15	5599
2004-02	SILHOUETTE	V6 3.4L	ITR4A15	5599
1995-94	SILHOUETTE	V6 3.8L	ITR4A15	5599
<b>PLYMOUTH</b>				
2001-01	PROWLER	V6 3.5L	ZFR5LP-13G	7781
<b>PONTIAC</b>				
2005-03	AZTEK	V6 3.4L	ITR4A15	5599
2005-93	BONNEVILLE	V6 3.8L	ITR4A15	5599
2002-95	FIREBIRD	V6 3.8L	ITR4A15	5599
2010-07	G5	L4 2.2L	ILTR5B11	3474
2008-07	G5	L4 2.4L	ILTR5B11	3474
2009-06	G6	L4 2.4L	ILTR5B11	3474
2010-10	G6	L4 2.4L	ILTR5E11	91418
2006-05	G6	V6 3.5L	ITR4A15	5599
2010-07	G6	V6 3.5L	IzTR4A11	4213
2009-06	G6	V6 3.9L	IzTR4A11	4213
2005-02	GRAND AM	L4 2.2L	ILTR5C11	5581
2005-03	GRAND AM	V6 3.4L	ITR4A15	5599
2008-97	GRAND PRIX	V6 3.8L	ITR4A15	5599
2005-03	MONTANA	V6 3.4L	ITR4A15	5599
2006-05	MONTANA	V6 3.5L	ITR4A15	5599
2009-06	MONTANA	V6 3.9L	IzTR4A11	4213
2006-05	PURSUIT	L4 2.2L	ILTR5C11	5581
2009-08	SOLSTICE	L4 2.0L	ILTR5D	5476
2009-06	SOLSTICE	L4 2.4L	ILTR5B11	3474
2005-02	SUNFIRE	L4 2.2L	ILTR5C11	5581
2009-06	TORRENT	V6 3.4L	ITR4A15	5599
1995-94	TRANS SPORT	V6 3.8L	ITR4A15	5599
2008-03	VIBE	L4 1.8L	IFR5T11	4996
2006-03	VIBE	L4 1.8L	IFR6T11	4589
2010-09	VIBE	L4 2.4L	IFR6T11	4589
<b>PORSCHE</b>				
2017-11	CAYENNE	V6 3.0L	PFR8S8EG	94460
2006-04	CAYENNE	V6 3.2L	IzKR7B	7563
2010-08	CAYENNE	V6 3.6L	ILZKR7A	1961
2017-11	CAYENNE	V6 3.6L	ILZKR8A	94290
2016-12	PANAMERA	V6 3.0L	PFR8S8EG	94460

YEAR	MODEL	ENGINE	NGK PART #	STOCK #
<b>RAM</b>				
2017-14	1500	V8 5.7L	LZFR5C1-11	92145
2017-14	2500	V8 5.7L	LZFR5C1-11	92145
2017-14	3500	V8 5.7L	LZFR5C1-11	92145
<b>ROLLS-ROYCE</b>				
2002-02	PARK WARD	V12 5.4L	BKR6EQUP	3199
2013-04	PHANTOM	V12 6.7L	BKR6EQUP	3199
2002-99	SILVER SERAPH	V12 5.4L	BKR6EQUP	3199
<b>SAAB</b>				
2005-05	9-2X	H4 2.0L	PFR6G	4793
2006-05	9-2X	H4 2.5L	FR5AP-11	5463
2006-06	9-2X	H4 2.5L	ILFR6B	6481
2003-00	9-3	L4 2.0L	PFR6H-10	6290
2011-04	9-3	L4 2.0L	PFR6T-10G	5542
2002-99	9-3	L4 2.3L	PFR6H-10	6290
2009-06	9-3	V6 2.8L	PLFR6C-10G	1959
2011-10	9-3X	L4 2.0L	PFR6T-10G	5542
2011-11	9-4X	V6 2.8L	DILFR7B10G	97218
2011-11	9-4X	V6 3.0L	ILTR6E11	90117
2011-11	9-5	L4 2.0L	ILTR5D	5476
2009-00	9-5	L4 2.3L	PFR6H-10	6290
2011-10	9-5	V6 2.8L	DILFR7B10G	97218
2009-05	9-7X	L6 4.2L	ILTR5B11	3474
<b>SATURN</b>				
2008-07	AURA	L4 2.4L	ILTR5B11	3474
2010-09	AURA	L4 2.4L	ILTR5E11	91418
2008-07	AURA	V6 3.5L	IzTR4A11	4213
2007-04	ION	L4 2.0L	IFR6V-10G	92085
2007-03	ION	L4 2.2L	ILTR5C11	5581
2007-06	ION	L4 2.4L	ILTR5B11	3474
2002-01	L100	L4 2.2L	ILTR5C11	5581
2003-01	L200	L4 2.2L	ILTR5C11	5581
2004-04	L300	L4 2.2L	ILTR5C11	5581
2000-00	LS	L4 2.2L	ILTR5C11	5581
2000-00	LS1	L4 2.2L	ILTR5C11	5581
2000-00	LW1	L4 2.2L	ILTR5C11	5581
2003-01	LW200	L4 2.2L	ILTR5C11	5581
2010-07	OUTLOOK	V6 3.6L	ILTR6E11	90117
2006-05	RELAY	V6 3.5L	ITR4A15	5599
2007-06	RELAY	V6 3.9L	IzTR4A11	4213
2010-07	SKY	L4 2.0L	ILTR5D	5476
2008-07	SKY	L4 2.4L	ILTR5B11	3474
2010-09	SKY	L4 2.4L	ILTR5E11	91418
2007-02	VUE	L4 2.2L	ILTR5C11	5581
2010-07	VUE	L4 2.4L	ILTR5B11	3474
2010-08	VUE	V6 3.5L	IzTR4A11	4213
2010-10	VUE	V6 3.6L	ILTR6E11	90117
<b>SUBARU</b>				
2007-06	B9 TRIBECA	H6 3.0L	ILFR6B	6481
2006-04	BAJA	H4 2.5L	FR5AP-11	5463
2006-04	BAJA	H4 2.5L	ILFR6B	6481
2016-16	CROSSTREK	H4 2.0L	DILZKAR7B11	90935
2017-16	CROSSTREK	H4 2.0L	SILZKAR7B11	93482
2017-14	FORESTER	H4 2.0L	ILKAR8H6	96024
2010-05	FORESTER	H4 2.5L	FR5AP-11	5463
2008-04	FORESTER	H4 2.5L	ILFR6B	6481
1998-98	FORESTER	H4 2.5L	PFR5B-11	2300
2013-09	FORESTER	H4 2.5L	SILFR6A	7913
2018-11	FORESTER	H4 2.5L	SILZKAR7B11	93482
2018-17	IMPREZA	H4 2.0L	DILKAR7B8	92217
2005-02	IMPREZA	H4 2.0L	PFR6G	4793
2016-12	IMPREZA	H4 2.0L	SILZKAR7B11	93482
2011-05	IMPREZA	H4 2.5L	FR5AP-11	5463
2007-04	IMPREZA	H4 2.5L	ILFR6B	6481
1998-98	IMPREZA	H4 2.5L	PFR5B-11	2300
2014-08	IMPREZA	H4 2.5L	SILFR6A	7913
2009-04	LEGACY	H4 2.5L	FR5AP-11	5463
1999-96	LEGACY	H4 2.5L	PFR5B-11	2300
2012-10	LEGACY	H4 2.5L	SIFR6A11	127
2009-05	LEGACY	H4 2.5L	SILFR6A	7913
2012-10	LEGACY	H4 2.5L	SILFR6B8	373

Note: Please refer to application section for detailed model listing



## Original Equipment Iridium and Platinum Spark Plugs

YEAR	MODEL	ENGINE	NGK PART #	STOCK #
<b>SUBARU</b>				
2017-13	LEGACY	H4 2.5L	SILZKAR7B11	93482
2009-08	LEGACY	H6 3.0L	ILFR6B	6481
2017-10	LEGACY	H6 3.6L	SILFR6C11	7505
2009-04	OUTBACK	H4 2.5L	FR5AP-11	5463
2012-10	OUTBACK	H4 2.5L	SIFR6A11	127
2009-05	OUTBACK	H4 2.5L	SILFR6A	7913
2017-13	OUTBACK	H4 2.5L	SILZKAR7B11	93482
2009-05	OUTBACK	H6 3.0L	ILFR6B	6481
2004-01	OUTBACK	H6 3.0L	PLFR6A-11	7654
2017-10	OUTBACK	H6 3.6L	SILFR6C11	7505
1997-92	SVX	H6 3.3L	PFR6B-11	4014
2009-08	TRIBECA	H6 3.6L	SILFR6A	7913
2014-10	TRIBECA	H6 3.6L	SILFR6C11	7505
2018-13	WRX STI	H4 2.5L	SILFR6A	7913
2018-15	WRX	H4 2.0L	ILKAR8H6	96024
2014-13	WRX	H4 2.5L	SILFR6A	7913
2015-14	XV CROSSTREK	H4 2.0L	DILZKAR7B11	90935
2015-13	XV CROSSTREK	H4 2.0L	SILZKAR7B11	93482
<b>SUZUKI</b>				
2003-02	AERIO	L4 2.0L	IFR5J11	7418
2007-04	AERIO	L4 2.3L	IFR5J11	7418
2012-09	EQUATOR	L4 2.5L	PLFR5A-11	6240
2012-09	EQUATOR	V6 4.0L	PLFR5A-11	6240
2002-01	ESTEEM	L4 1.8L	IFR6J11	7658
2012-09	GRAND VITARA	L4 2.4L	SILFR6A11	5468
2005-00	GRAND VITARA	V6 2.5L	IFR5J11	7418
2001-01	GRAND VITARA	V6 2.7L	IFR5J11	7418
2008-06	GRAND VITARA	V6 2.7L	IFR6J11	7658
2012-10	KIZASHI	L4 2.4L	SILFR6A11	5468
2012-12	SX4 CROSSOVER	L4 2.0L	SILFR5A11	92373
2009-07	SX4	L4 2.0L	IFR5J11	7418
2013-10	SX4	L4 2.0L	SILFR5A11	92373
2006-05	VERONA	L6 2.5L	IFR6E11	6741
2002-01	VITARA	L4 1.6L	IFR6E11	6741
2003-00	VITARA	L4 2.0L	IFR5J11	7418
2004-04	VITARA	V6 2.5L	IFR5J11	7418
2003-02	XL-7	V6 2.7L	IFR5J11	7418
2006-04	XL-7	V6 2.7L	IFR6J11	7658
<b>TOYOTA</b>				
1999-96	AVALON	V6 3.0L	BKR6EKP-11	3452
1995-95	AVALON	V6 3.0L	BKR6EP-11	2978
2002-00	AVALON	V6 3.0L	IFR6T11	4589
2001-97	CAMRY	L4 2.2L	BKR6EKP-11	3452
1996-92	CAMRY	L4 2.2L	BKR6EP-11	2978
2004-02	CAMRY	L4 2.4L	IFR6T11	4589
1991-88	CAMRY	V6 2.5L	BCPR6EP-11	3350
1993-92	CAMRY	V6 3.0L	BCPR6EP-11	3350
2001-96	CAMRY	V6 3.0L	BKR6EKP-11	3452
1995-94	CAMRY	V6 3.0L	BKR6EP-11	2978
2006-02	CAMRY	V6 3.0L	IFR6T11	4589
2004-04	CAMRY	V6 3.3L	IFR6T11	4589
2003-00	CELICA	L4 1.8L	IFR5T11	4996
2003-00	CELICA	L4 1.8L	IFR6T11	4589
1989-86	CELICA	L4 2.0L	BCPR5EP-11	2097
1993-90	CELICA	L4 2.0L	BKR6EP-8	2215
1999-91	CELICA	L4 2.2L	BKR6EP-11	2978
1985-83	CELICA	L6 2.8L	BPR5EP-11	3971
1989-85	COROLLA	L4 1.6L	BCPR5EP-11	2097
2004-00	COROLLA	L4 1.8L	IFR5T11	4996
1988-82	CRESSIDA	L6 2.8L	BPR5EP-11	3971
2003-01	HIGHLANDER	V6 3.0L	IFR6T11	4589
2004-98	LAND CRUISER	V8 4.7L	IFR6T11	4589
2006-03	MATRIX	L4 1.8L	IFR6T11	4589
2002-00	MR2 SPYDER	L4 1.8L	IFR5T11	4996
1989-85	MR2	L4 1.6L	BCPR5EP-11	2097
1989-88	MR2	L4 1.6L	BCPR6EP-11	3350
1995-91	MR2	L4 2.0L	BKR6EP-8	2215
1995-92	MR2	L4 2.2L	BKR6EP-11	2978
1995-91	PREVIA	L4 2.4L	BKR5EP-11	3440

YEAR	MODEL	ENGINE	NGK PART #	STOCK #
<b>TOYOTA</b>				
1997-95	PREVIA	L4 2.4L	BKR6EP-11	2978
2003-01	PRIUS	L4 1.5L	IFR5T11	4996
2000-97	RAV4	L4 2.0L	BKR6EKP-11	3452
1996-96	RAV4	L4 2.0L	BKR6EP-11	2978
2003-01	RAV4	L4 2.0L	IFR6T11	4589
2000-98	SIENNA	V6 3.0L	BKR6EKP-11	3452
2003-01	SIENNA	V6 3.0L	IFR6T11	4589
2001-99	SOLARA	L4 2.2L	BKR6EKP-11	3452
2003-02	SOLARA	L4 2.4L	IFR6T11	4589
2001-99	SOLARA	V6 3.0L	BKR6EKP-11	3452
2003-02	SOLARA	V6 3.0L	IFR6T11	4589
2006-05	SOLARA	V6 3.3L	IFR6T11	4589
1984-83	STARLET	L4 1.3L	BPR5EP-11	3971
1992-86	SUPRA	L6 3.0L	BCPR5EP-11	2097
1992-87	SUPRA	L6 3.0L	BCPR6EP-N-8	5275
1998-98	SUPRA	L6 3.0L	BKR5EKP-11	4302
1997-93	SUPRA	L6 3.0L	BKR5EP-11	3440
1998-93	SUPRA	L6 3.0L	BKR6EP-11	2978
2004-03	TACOMA	L4 2.4L	IFR5T11	4996
1985-84	VAN	L4 2.0L	BPR5EP-11	3971
1989-86	VAN	L4 2.2L	BPR5EP-11	3971
<b>VOLKSWAGEN</b>				
2005-99	BEETLE	L4 1.8L	PFR6Q	6458
2017-14	BEETLE	L4 1.8L	PLFER7A8EG	94833
2013-12	BEETLE	L4 2.0L	PFR7S8EG	1675
2016-13	BEETLE	L4 2.0L	PLFER7A8EG	94833
2005-01	BEETLE	L4 2.0L	PZFR5D-11	7968
2008-06	BEETLE	L5 2.5L	PZFR5Q-11	6737
2002-02	CABRIO	L4 2.0L	PFR6Q	6458
2017-09	CC	L4 2.0L	PFR7S8EG	1675
2017-09	CC	V6 3.6L	ILZKR7A	1961
2016-09	EOS	L4 2.0L	PFR7S8EG	1675
2008-07	EOS	V6 3.2L	IZKR7B	7563
2003-97	EUROVAN	V6 2.8L	BKR5EKUP	2890
2002-01	EUROVAN	V6 2.8L	PZFR5D-11	7968
2017-17	GOLF ALLTRACK	L4 1.8L	PLFER7A8EG	94833
2010-07	GOLF CITY	L4 2.0L	PZFR5D-11	7968
2017-15	GOLF R	L4 2.0L	PLFER7A8EG	94833
2017-15	GOLF SPORTWAGEN	L4 1.8L	PLFER7A8EG	94833
2006-00	GOLF	L4 1.8L	PFR6Q	6458
2017-15	GOLF	L4 1.8L	PLFER7A8EG	94833
2013-13	GOLF	L4 2.0L	PFR7S8EG	1675
2006-01	GOLF	L4 2.0L	PZFR5D-11	7968
2002-02	GOLF	V6 2.8L	BKR5EKUP	2890
2005-02	GOLF	V6 2.8L	PZFR5D-11	7968
2004-04	GOLF	V6 3.2L	IZKR7B	7563
2014-10	GTI	L4 2.0L	PFR7S8EG	1675
2017-15	GTI	L4 2.0L	PLFER7A8EG	94833
2009-07	JETTA CITY	L4 2.0L	PZFR5D-11	7968
2005-00	JETTA	L4 1.8L	PFR6Q	6458
2017-14	JETTA	L4 1.8L	PLFER7A8EG	94833
2013-12	JETTA	L4 2.0L	PFR7S8EG	1675
2017-13	JETTA	L4 2.0L	PLFER7A8EG	94833
2005-01	JETTA	L4 2.0L	PZFR5D-11	7968
2007-05	JETTA	L5 2.5L	PZFR5Q-11	6737
2002-94	JETTA	V6 2.8L	BKR5EKUP	2890
2004-02	JETTA	V6 2.8L	PZFR5D-11	7968
2010-09	PASSAT CC	L4 2.0L	PFR7S8EG	1675
2010-09	PASSAT CC	V6 3.6L	ILZKR7A	1961
2005-01	PASSAT	L4 1.8L	PFR6Q	6458
2017-14	PASSAT	L4 1.8L	PLFER7A8EG	94833
2010-09	PASSAT	L4 2.0L	PFR7S8EG	1675
2017-06	PASSAT	V6 3.6L	ILZKR7A	1961
2006-06	PHAETON	W12 6.0L	PZFR5J-11	7743
2005-04	PHAETON	W12 6.0L	PZFR6J-11	3586
2008-08	R32	V6 3.2L	IZKR7B	7563
2009-06	RABBIT	L5 2.5L	PZFR5Q-11	6737
2010-09	ROUTAN	V6 4.0L	ZFR5LP-13G	7781
2017-09	TIGUAN	L4 2.0L	PFR7S8EG	1675

Note: Please refer to application section for detailed model listing



# Original Equipment Iridium and Platinum Spark Plugs

THE IGNITION SPECIALIST

YEAR	MODEL	ENGINE	NGK PART #	STOCK #
VOLKSWAGEN				
2015-11	TOUAREG	V6 3.0L	PFR8S8EG	94460
2006-04	TOUAREG	V6 3.2L	IZKR7B	7563
2016-07	TOUAREG	V6 3.6L	ILZKR7A	1961
2009-07	TOUAREG	V8 4.2L	PFR6W-TG	5547
VOLVO				
2011-07	S80	L6 3.2L	ILFR6B	6481
2010-07	S80	V8 4.4L	IFR6B11	5368
2010-08	V70	L6 3.2L	ILFR6B	6481
2011-10	XC60	L6 3.2L	ILFR6B	6481
2011-08	XC70	L6 3.2L	ILFR6B	6481
2011-07	XC90	L6 3.2L	ILFR6B	6481
2011-05	XC90	V8 4.4L	IFR6B11	5368

Note: Please refer to application section for detailed model listing







# Superseded and Discontinued Part Numbers

THE IGNITION SPECIALIST

OLD PART #	STK #	NEW PART #	STK #
B105EGV	2171	BR10EIX	6801
B11EGV	5831	BR10EIX	6801
B8EGV	5627	BR8EIX	5044
B95EGV	2145	BR10EIX	6801
B9EGV	5827	BR9EIX	3981
BP6EF	4666	BPR6EFS	3623
BPMR4A	6028	BPMR4A SOLID	5113
BR10ECS	5880	BR10ECS SOLID	5940
BR8EQ	3328	BR8EQ-14	2329
BUR6EFSZ	6837	---	---
CY51	2696	---	---
DF8H-11B	1305	DF8H-11B	90174
FR2A-D	4768	FR2B-D	1598
ILFR6G	5588	ILFR6G-E	4212
ILKAR6C10	95843	ILKAR7C10	94940
ILTR5A-13G	3811	ILTR5K13 / LTR5BI-13	90607 / 90083
ILTR6A-13G	3789	LTR6BI-13	91725
ILZKBR7A-8G	5992	ILZKBR7B8DG	95770
IZFR6J	4462	---	---
IZFR6J11	92383	IZFR6J	4462
LTR6AI-9	96780	LTR6CI-8	97177
PFR6W-T	6740	PFR6W-TG	5547
PFR7N-D	6504	PFR7N8DS	93580
PGR6A-11	3738	---	---
PLZKBR7A-G	5843	PLZKBR7B8DG	90223
PZFR6B	5200	---	---
R0045J-10	7400	R0045Q-10	4216
R0161-11	5187	---	---
R0373A-8	3407	---	---

OLD PART #	STK #	NEW PART #	STK #
R4118S-7	2777	---	---
R4118S-85	7035	---	---
R4118S-9	3245	BR9EIX	3981
R4304A-10	2184	BPR10EIX	95236
R4304A-9	2158	BPR9EIX	6853
R5184-10	7457	---	---
R5525-10	2098	BR10HIX	6692
R5525-11	2844	---	---
R5525-7	6241	BR7HIX	7067
R5525-8	7383	BR8HIX	7001
R5525-9	3914	BR9HIX	5687
R5883-11	6077	---	---
R6179A-105P	2697	R6252E-105	2396
R6179A-11P	3698	---	---
R6252E-9	4741	---	---
R7282A-10	3920	---	---
R7282A-11	4754	---	---
R7433-10	4891	---	---
R7435-8	4895	BKR8EIX	2668
R7436-10	4900	---	---
R7436-9	4899	---	---
R7440A-9L	3795	---	---
R7440B-10T	5009	---	---
R7440B-11T	5495	---	---
R847-11	4653	---	---
Y-303	3079	---	---
Y-904M1	7995	---	---
Y-918R	4182	Y-918J	3704
Y-925R	5045	---	---

## New Spark Plug Primary Applications

NEW PART #	STK #	PRIMARY APPLICATIONS
BKR6EZB	4293	MERCEDES BENZ B200 2011-06
BKUR6ETB	6992	CHEVROLET OPTRA 2004, SUZUKI VERONA 2004
BPR5EFS-13	2359	MERCUSIER 4.5L
CMR7A-5	4641	C/SAW - MAKITA
CPR6EA-9S	1582	M/C - 2013 HONDA
CR9EIB-9	92579	M/C - 2013 MV AGUSTA
CZ159	92053	MERCEDES BENZ 2015-14
DCPR7EGP	1682	FIAT 2015-14
DF6H-11A	94702	NISSAN 2013
DF8H-11B	90174	INFINITI 2014-11, NISSAN 2014-11
DILKAR7H11GS	96964	ACURA ILX 2016, TLX 2015, HONDA CR-V 2015
DILZKAR7B11	90935	SUBARU XV CROSSTREK 2015-14
DILZKAR7C11S	90137	HONDA 2015
DILZKR7B11G	95350	ACURA 2014
ER9EHIX	96652	M/C - PIAGGIO 2016, VESPA 2011-09
IFR6G-11K	1314	M/C - HONDA 2014-13
IFR6V-10G	92085	CHEVROLET COBALT 2007-05, SAAB 9-3 2011-03, 9-3X 2011, SATURN ION 2007-04
IKR7H8	91715	FIAT 2014
ILKR8Q7	93819	SNOW - 2017 SKI-DOO
ILTR5K13	90607	FORD EDGE 2011-07, ESCAPE 2011-09, FLEX 2012-09, FUSION 2012-06, TAURUS 2012-08, TAURUS X 2009-08; LINCOLN MKS 2013-09, MKT 2012-10, MKX 2010-07, MKZ 2012-07; MERCURY MARINER 2011-09, MILAN 2011-06, SABLE 2009-08
ILTR5L11	96329	CADILLAC ATS 2014, CHEVROLET IMPALA 2014-13, MALIBU 2014-13
ILTR5M9G	90882	CHEVROLET MALIBU 2013
ILTR6M9G	94489	BUICK REGAL 2014, CHEVROLET MALIBU 2014
ILTR7E9	90543	CADILLAC CTS 2014, XTS 2014
ILZKAR8H8S	95112	HONDA 2017-16
ILZKAR8J8SY	95660	HONDA 2017
ILZKBR7B8DG	95770	MINI COOPER 2012-07
ILZNR8A7G	91924	FORD FUSION 2017-14
ILZTR6A8G	94769	FORD 2015

## New Spark Plug Primary Applications

NEW PART #	STK #	PRIMARY APPLICATIONS
ITR6G9	90156	Ford Shelby GT500 2014-13
IZFR6K-11E	6748	OUTBOARD - HONDA
KR8BI	4347	M/C- 2016-10CAN-AM
KR9C-G	90893	PWC - 2016 BOMBARDIER (SEA-DOO)
LKAR7AGP-D	93220	2015-08 INFINITI, 2015-11 LEXUS, 2015-12 MAZDA, 2015-07 NISSAN, 2010-09 PONTIAC, 2014-08 SCION, 2015-09 TOYOTA
LKR7AIX	93911	2014-11 Chrysler 300, Dodge Challenger/Charger, Jeep Grand Cherokee
LMAR8A-9	4313	M/C - YAMAHA 2016-15
LMAR8A-9S	6817	M/C - HONDA 2013
LMAR8AI-8	92288	M/C - BMW 2016-10
LMAR8BI-9	91909	M/C - SUZUKI 2016-15
LMAR8F-9	90894	M/C - MOTO GUZZI 2016-14
LR4C-E	94931	GENERATOR - HONDA
LTR5BI-13	90083	MAZDA 3 2013-06, 3 SPORT 2013-12, 5 2014-12 2010-08, 6 2013-06, CX-7 2012-10, TRIBUTE 2011-09
LTR6AI13	95853	FORD F-150 2013-11, MUSTANG 2013-11
LTR6BI-13	91725	MAZDA 2014-06
LTR6BI-9	92182	FORD FOCUS 2014-12
LTR6CI-8	97177	Ford Taurus, F-150 2014-13
LTR6DI-8	96588	Ford Edge 2014, Ford Escape 2014-13
LTR6DP13	90374	FORD 2015-11
LZFR5CI-11	92145	CHRYSLER 2015-14, DODGE 2015-14
LZKR6AIX	92873	HYUNDAI 2012-09, KIA 2011-09
LZTR6AP11EG	97408	Chrysler Town & Country 2014-12, Jeep Cherokee/ Grand Cherokee 2014, Ram ProMaster 1500-3500 2014
MR7F	95897	ATV - Polaris RZR 900 2015, RZR 570, Ranger 570, Sportsman 570, M/C - Indian 2016-15
MR8BI-8	91360	SNOW - 2015 SKI-DOO
MR8F	90299	ATV - POLARIS 2016
MR9F	95884	ATV - POLARIS 2017
PLFER7A8EG	94833	VOLKSWAGEN BEETLE 2015-13, JETTA 2014-13, PASSAT 2015-14
PLZKBR7B8DG	90223	MINI COOPER 2014-11, COOPER COUNTRYMAN 2014-11, COOPER PACEMAN 2014-13
R0465B-10	7506	RACING PLUG
R8102B-10	95746	RACING PLUG
SILMAR8A9S	90992	M/C- 2016 HONDA
SILMAR9B9	95399	KAWASAKI 2016-15
SILZKAR7E8S	93476	JAGUAR 2016-12, LAND ROVER 2016-14
SILZKBR8D8S	97506	BMW 2015
SILZKBR8E8S	96987	BMW 528i 2012, 528i XDRIVE 2012, Z4 2012
SILZKFR8D7S	95875	MERCEDES-BENZ 2014
SILZKFR8E7S	90654	MERCEDES-BENZ 2013-2012
SILZKR7B8E	93411	Hyundai Veloster Turbo 2014 - from Prod. Date 12/13/2013
SILZKR7E8EG	93655	HYUNDAI 2015
SILZKR7E9G	91467	HYUNDAI 2015
SPMR8A6HDG	92264	FERRARI CALIFORNIA 2013-09
TR45-1IX	6744	FORD FREESTAR 2007-06
TR65IX	3692	ASTON MARTIN VANQUISH 2006-03, FORD ESCAPE 2005, F-150 2003, FOCUS 2010-03, MUSTANG 2004-03, JAGUAR S-TYPE 2006-05, X-TYPE 2006-03, MAZDA 3 2005-04
TR6AP-13E	4968	JAGUAR 2013
Y1013J	94288	TOYOTA 2002-93
Y1021J	97627	AGRICULTURE - JOHN DEERE, INDUSTRIAL ENGINE - YANMAR
Y-510R	91712	AGRICULTURE - MASSEY FERGUSON
Y-543J	6600	SMART FORTWO 2007-05
Y-546J	95275	LAWN MOWER - CUB CADET, FERRIS, JOHN DEERE, KOBELCO, PE ENGINES- YANMAR
Y-724U	3973	LAWN MOWER - CUB CADET, MAHINDRA, PE ENGINES- MITSUBISHI
Y-930U	5568	MERCEDES BENZ E300 1995



## Spark Plug Specification Chart Index

<b>Plug Style:</b>	<b>Page</b>
8mm Spark Plug Profile and Spark Plug Tip Images.....	14-15
10mm Spark Plug Profile and Spark Plug Tip Images.....	14-17
PF1/2S Spark Plug Profile and Spark Plug Tip Images.....	16-17
12mm Spark Plug Profile and Spark Plug Tip Images.....	18-23
14mm Spark Plug Profile and Spark Plug Tip Images.....	24-47
18mm Spark Plug Profile and Spark Plug Tip Images.....	46-47
Racing Spark Plug Profile and Spark Plug Tip Images.....	48-51

**Spark Plug Specification Chart Index**

<b>Plug Style:</b>	<b>Page</b>
8mm Spark Plug Profile and Spark Plug Tip Images.....	26-27
10mm Spark Plug Profile and Spark Plug Tip Images.....	26-29
PF1/2S Spark Plug Profile and Spark Plug Tip Images.....	30-31
12mm Spark Plug Profile and Spark Plug Tip Images.....	30-37
14mm Spark Plug Profile and Spark Plug Tip Images.....	38-61
18mm Spark Plug Profile and Spark Plug Tip Images.....	60-61
HX Spark Plug Profile and Spark Plug Tip Images.....	62-63
Racing Spark Plug Profile and Spark Plug Tip Images.....	64-67





# NGK Spark Plug Specification Chart

THE IGNITION SPECIALIST™

Spark Plug charts are sorted by thread size, thread reach, hex size. Hotter plugs are listed above the colder plugs. Plug images are located on the opposite page.

	STD. NON-RESISTOR			STD. RESISTOR			V-POWER			PLATINUM			IRIDIUM		
	Part No.	Stk No.	Image	Part No.	Stk No.	Image	Part No.	Stk No.	Image	Part No.	Stk No.	Image	Part No.	Stk No.	Image
<b>8mm Spark Plugs</b>															
3/4" Reach 13mm Hex Gasket, Stud				ER9EH	5869	215 FW							ER8EHIX ER9EHIX	8201 96652	321 JA 321 JA
<b>10mm Spark Plugs</b>															
8.5mm Reach 13/16" Hex Gasket, Loose	C-50	5712	205 FP												
8.6mm Reach 5/8" Hex Gasket, Solid	CM-6	5812	211 FT												
3/8" Reach 5/8" Hex Compact Gasket, Solid				CMR4A CMR6A CMR7A CMR7A-5	5474 1223 7543 4641	9 I 9 I 9 I 9 I									
1/2" Reach 5/8" Hex Compact Gasket, Solid				CMR4H CMR5H CMR6H CMR7H CMR8H	5246 7599 3365 3066 95741	300 IK 300 IK 300 IK 300 IK 300 IK									
1/2" Reach 5/8 Hex Compact Wide Gap Gasket, Solid				CMR7H-10	1656	300 IK									
1/2" Reach 5/8" Hex Gasket, Stud	C2H	2211	33 DN	CR4HSA CR5HSA CR6HS CR6HSA CR7HS CR7HSA	2430 7840 7023 2983 7223 4549	44 DN 44 DN 44 DN 44 DN 44 DN 44 DN						CR6HIX	7274	280 HW	
	C6HSA	3228	73 DN	CR6HSA CR7HS CR7HSA	2983 7223 4549	44 DN 44 DN 44 DN						CR7HIX	7544	280 HW	
	C7HSA	4629	73 DN	CR7HSA	4549	44 DN						CR8HIX	7669	280 HW	
	C8HA	2168	73 DN	CR8HSA	2086	44 DN									
	C8HSA	6821	73 DN	CR8HSA	2086	44 DN									
1/2" Reach 5/8" Hex Wide Gap Gasket, Stud				CR7HSA-9	95372	44 DN									
1/2" Reach 5/8" Hex Gasket, Solid				CR4HSB LR4C-E CR5HSB CR6HSB LR8B	4695 94931 6535 6500 6208	148 DN 233 GK 148 DN 148 DN 233 GK									
3/4" Reach 5/8" Hex Gasket, Stud	C7E C8E C9E	5096 7471 7499	177 EJ 177 EJ 177 EJ	CR6E CR7E CR8E CR9E CR10E	6965 4578 1275 6263 6264	235 EJ 235 EJ 235 EJ 235 EJ 235 EJ									
3/4" Reach 5/8" Hex Gasket, Loose													CR7EIX CR8EIX CR9EIX CR10EIX	7385 4218 3521 6482	285 IB 285 IB 285 IB 285 IB
3/4" Reach 5/8" Hex Gasket, Solid				CR7EB CR8EB CR9EB	4663 7784 6955	146 EJ 146 EJ 146 EJ			PMR7A PMR8B PMR8A PMR9A	4259 6378 5851 4717	146 CM 146 CM 146 CM 146 CM	MR7BI-8 MR8A19 MR8BI-8 CR8EIB-9 CR9EIB-9	90982 7692 91360 5258 92579	303 IM 303 IM 319 IM 169 EC 169 EC	
3/4" Reach 5/8" Hex Wide Gap Gasket, Solid													CR8EIB-10	4948	169 EC
3/4" Reach 5/8" Hex Wide Gap Gasket, Stud													CR6EIA-9 CR7EIA-9 CR8EIA-9 CR8EIA-10 CR9EIA-9	7967 91175 4286 4708 6289	319 IX 319 IX 319 IX 319 IX 319 IX
3/4" Reach 5/8" Hex Projected Gasket, Solid				MR7F MR8F CPR8E MR9F	95897 90299 7411 95844	146 EJ 146 EJ 221 GB 146 EJ									
3/4" Reach 14mm Hex 2-Ground Electrode Gasket, Solid				MAR9A-J MAR10A-J	6869 4706	150 DL 150 DL									
3/4" Reach 14 mm Hex Partial Thread 2-Ground Electrode Gasket, Solid				MAR8B-JDS	8765	364 KT									

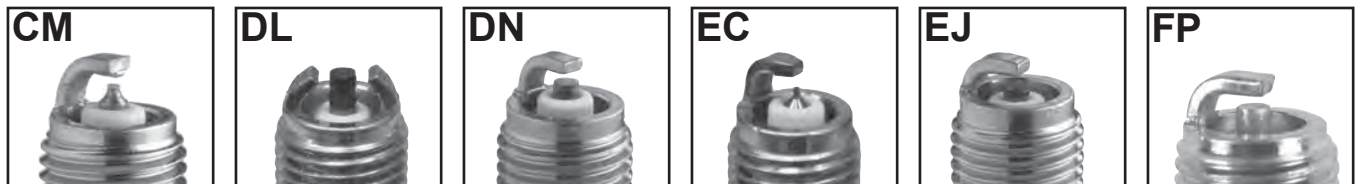



# NGK Spark Plug Specification Chart

THE IGNITION SPECIALIST™

Spark Plug charts are sorted by thread size, thread reach, hex size. Hotter plugs are listed above the colder plugs. Plug images are located on the opposite page.

	STD. NON-RESISTOR			STD. RESISTOR			V-POWER			PLATINUM			IRIDIUM		
	Part No.	Stk No.	Image	Part No.	Stk No.	Image	Part No.	Stk No.	Image	Part No.	Stk No.	Image	Part No.	Stk No.	Image
<b>10mm Spark Plugs cont'd</b>															
3/4" Reach 5/8" Hex Projected, Wide Gap Gasket, Stud				CPR6EA-9 CPR6EA-9S CPR7EA-9 CPR8EA-9 CPR9EA-9	6899 1582 3901 2306 2308	107 CF 107 CF 107 CF 107 CF 107 CF							CPR7EAIX-9	9198	322 JB
3/4" Reach 5/8" Hex Projected, Wide Gap Gasket, Solid				CPR6EB-9 CPR8EB-9 CPR9EB-9	5958 6607 6508	221 GB 221 GB 221 GB							IMR8E-9HES	95397	207 FQ
3/4" Reach 5/8" Hex Partial Thread, Wide Gap Gasket, Stud	C8EH-9	7473	293 HC	CR5EH-9 CR6EH-9 CR7EH-9 CR8EH-9 CR9EH-9	6689 2688 3486 5666 7502	253 HC 253 HC 253 HC 253 HC 253 HC							CR8EHIX-9 IMR8C-9H IMR8E-9HES CR9EHI-9 CR9EHIX-9 IMR9A-9H IMR9C-9H IMR9C-9HE IMR9C-9HES IMR9E-9HES IMR9B-9H IMR9D-9H	3797 3653 95397 6419 6216 6966 6777 6501 5766 7756 4888 6544	103 CD 94 BU 207 FQ 240 GQ 103 CD 240 GQ 240 HF 94 BU 207 FQ 207 FQ 249 GZ 249 GZ
3/4" Reach 5/8" Hex Partial Thread, Wide Gap Gasket, Solid				CR7EK CR8EK CR9EK CR10EK	7546 3478 4548 2360	41 AD 41 AD 41 AD 41 AD				CR8EKPA CR9EKPA	6985 7785	269 HN 269 HN			
3/4" Reach 5/8" Hex 2-Ground Electrode Gasket, Solid				CR7EKB CR8EKB CR9EKB	4455 4374 2305	36 Z 36 Z 36 Z									
3/4" Reach 5/8" Hex Projected, Wide Gap Dual Fine Electrode Gasket, Solid													DIMR8C10	92743	176 EI
22 mm Reach 5/8" Hex Gasket, Solid										SPMR8A6HDG	92264	151Q			
26.5 mm Reach 14 mm Hex Gasket, Solid				LMAR8F-9	90894	360 KP							LMAR8AI-8 LMAR8BI-9 LMAR9AI-8	92288 91909 97225	362 KK 362 KK 362 KK
26.5 mm Reach 14 mm Hex Wide Gap Gasket, Solid													LMAR9AI-10	93188	362 KK
26.5mm Reach 14mm Hex Projected Gasket, Stud				LMAR6A-9 LMAR7A-9 LMAR8A-9 LMAR8A-9S	5946 4908 4313 6817	166 DZ 166 DZ 166 DZ 166 DZ							LMAR7DI-10	96956	382 LP
26.5mm Reach 14mm Hex Projected Gasket, Solid				LMAR6C-9 LMAR8C-9	1679 93833	360 KP 360 KP									
26.5mm Reach 14mm Hex 2-Ground Electrode Gasket, Solid				LMAR8D-J LMAR9D-J	93444 1633	361 KQ 361 KQ									
26.5mm Reach 14mm Hex Projected 2-Ground Electrode Gasket,				LMAR9E-J	6884	264 HK									
26.5mm Reach 14mm Hex, SPE Gasket, Solid													SILMAR7A9S SILMAR8A9S SILMAR9A9S SILMAR10A9S SILMAR9B9	93675 90992 6213 7764 95399	308 IQ 308 IQ 308 IQ 308 IQ 382 LP
26.5mm Reach 5/8" Hex, SPE Gasket, Stud															

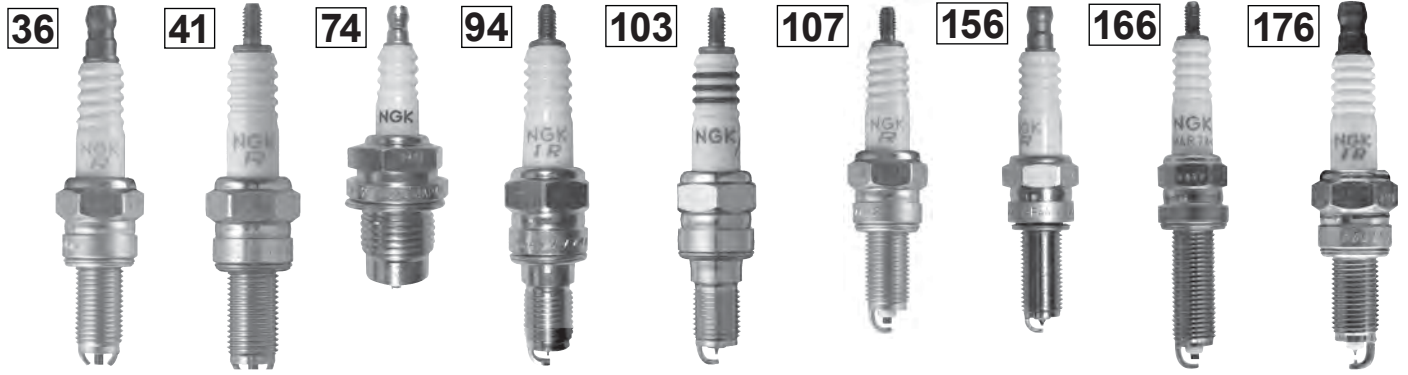



# NGK Spark Plug Specification Chart

THE IGNITION SPECIALIST™

Spark Plug charts are sorted by thread size, thread reach, hex size. Hotter plugs are listed above the colder plugs. Plug images are located on the opposite page.

	STD. NON-RESISTOR			STD. RESISTOR			V-POWER			PLATINUM			IRIDIUM		
	Part No.	Stk No.	Image	Part No.	Stk No.	Image	Part No.	Stk No.	Image	Part No.	Stk No.	Image	Part No.	Stk No.	Image
<b>PF1/2S Spark Plugs</b>															
22.5mm Reach 23.8mm Hex Gasket, Stud	G-2Z	3320	74 BE												
<b>12mm Spark Plugs</b>															
1/2" Reach 18mm Hex Gasket, Stud	D6HA D8HA	6512 7112	248 GY 248 GY	DR4HS DR5HS DR6HS DR8HS	3326 4623 4823 5123	77 GY 77 GY 77 GY 77 GY									
3/4" Reach 5/8" Hex Projected Gasket, Loose				DCPR7E DCPR8E	3932 4339	130 BL 130 BL							DCPR6EIX DCPR7EIX DCPR8EIX KR8DI DCPR9EIX	8196 6046 6546 4742 2316	229 GH 229 GH 229 GH 154 DP 229 GH
3/4" Reach 5/8" Hex Projected, Wide Gap Gasket, Solid				DCPR7E-N-10	4983	130 B									
3/4" Reach 5/8" Hex Projected Gasket, Solid				DCPR6E DCPR8E DCPR9E KR9C-G KR9E-G	3481 4179 2641 90893 93226	84 BL 84 BL 84 BL 84 BL 84 BL				DCPR7EGP PKR7A	1682 3641	93 BT 93 BT	IKR7H8 KR8AI KR8BI KR9CI	91715 5477 4347 7795	387 DP 229 GH 387 DP 154 DP
3/4" Reach 5/8" Hex 2-Ground Electrode Gasket, Solid				DCPR8EKC	7168	287 ID				DCPR8EKP	7415	287 ID			
3/4" Reach 5/8" Hex Extended Shell Gasket, Solid													IZKR7B	7563	298 II
3/4" Reach 18mm Hex Gasket, Stud	D6EA D7EA D8EA D9EA J9A J10A	7512 7912 2120 2420 2170 7444	296 IE 296 IE 296 IE 296 IE 296 IE 296 IE	DR7ES DR7EA DR8EA DR8ES DR9EA JR9B JR10B	3123 7839 7162 5423 3437 3188 1299	67 IE 312 IE 67 IE 67 IE 67 IE 15 N 15 N							DR7EIX DR8EIX DR9EIX	5686 6681 4772	203 FN 203 FN 203 FN
3/4" Reach 18mm Hex Half Heat Range Cooler Gasket, Stud				DR8ES-L	2923	67 IE									
3/4" Reach 18mm Hex Gasket, Solid				DR7EB DR8EB	5469 4855	67 IE 67 IE									



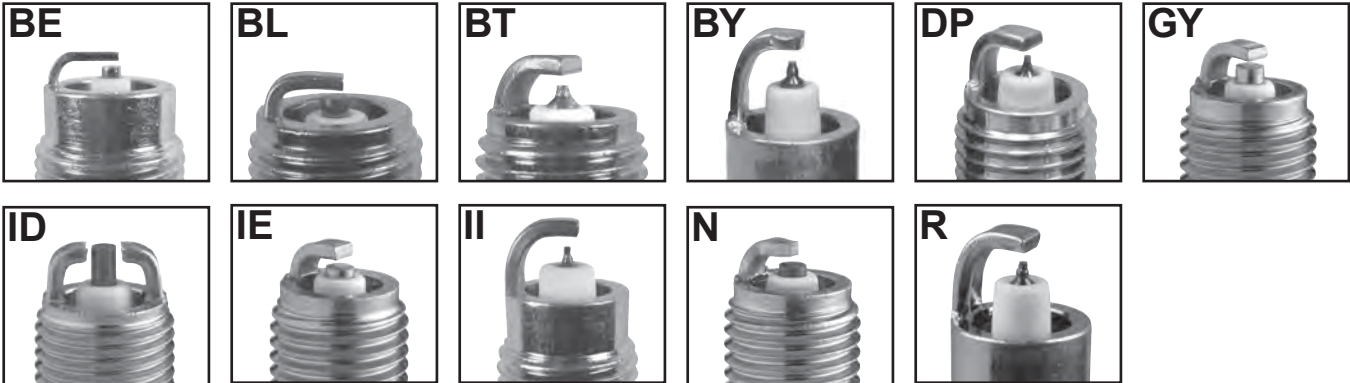
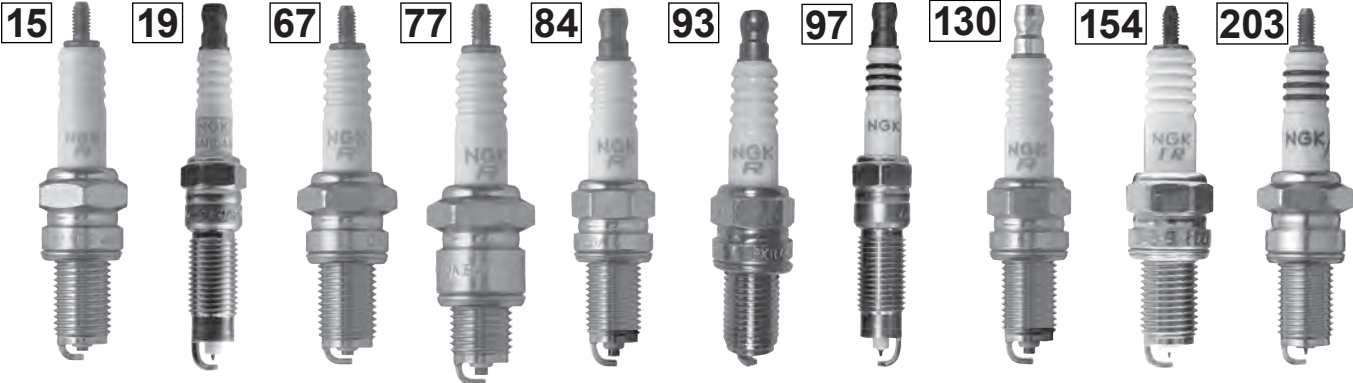



# NGK Spark Plug Specification Chart

THE IGNITION SPECIALIST™

Spark Plug charts are sorted by thread size, thread reach, hex size. Hotter plugs are listed above the colder plugs. Plug images are located on the opposite page.

	STD. NON-RESISTOR			STD. RESISTOR			V-POWER			PLATINUM			IRIDIUM		
	Part No.	Stk No.	Image	Part No.	Stk No.	Image	Part No.	Stk No.	Image	Part No.	Stk No.	Image	Part No.	Stk No.	Image
<b>12mm Spark Plugs cont'd</b>															
3/4" Reach 18mm Hex Projected Gasket, Stud										PJR7A	2842	314 IT			
3/4" Reach 18mm Hex Projected, Wide Gap Gasket, Stud	DP6EA-9 DP7EA-9 DP8EA-9 DP9EA-9	1068 5629 5829 6629	2 B 2 B 2 B 2 B	DPR5EA-9 DPR6EA-9 DPR7EA-9 DPR8EA-9 DPR9EA-9	2887 5531 5129 4929 5329	56 B 56 B 56 B 56 B 56 B							IJR7AP DPR7EIX-9 DPR8EIX-9 DPR9EIX-9	7901 7803 2202 5545	314 IT 309 IR 309 IR 309 IR
3/4" Reach 18mm Hex Projected, Wide Gap Gasket, Solid				DPR6EB-9	3108	64 AX									
3/4" Reach 18mm Hex 2-Ground Electrode Gasket, Stud				JR8C JR9C	5139 6193	181 EN 181 EN									
3/4" Reach 18mm Hex Projected, Extended Shell Gasket, Stud				DPR8Z DPR9Z	4730 4830	153 DO 153 DO									
23.7 mm Reach Bi-Hex, 14 mm Extended Shell Extended Projection SPE Gasket, Solid													SIZKBR8A8HS	1555	371 KR
25mm Reach 14mm Hex Projected Tapered Solid													SILZNR6D9 SILNAR7B7 SILZNR8C7H ILNAR8B7G	94051 93227 93593 91970	394 LY 391 FN 395 LZ 391 GH





# NGK Spark Plug Specification Chart

THE IGNITION SPECIALIST™

Spark Plug charts are sorted by thread size, thread reach, hex size. Hotter plugs are listed above the colder plugs. Plug images are located on the opposite page.

	STD. NON-RESISTOR			STD. RESISTOR			V-POWER			PLATINUM			IRIDIUM		
	Part No.	Stk No.	Image	Part No.	Stk No.	Image	Part No.	Stk No.	Image	Part No.	Stk No.	Image	Part No.	Stk No.	Image
<b>12mm Spark Plugs cont'd</b>															
25 mm Reach 14 mm, Hex Extended Shell Extended Projection Tapered, Solid													ILZNR8A7G	91924	19 R
26.5mm Reach 14mm Hex Extended Projection Wide Gap Tapered, Solid										ZNAR6AGP PZNAR6A11H	1698 5507	19 R 194 FC	ZNAR6AIX-11 ZNAR7AIX	372 7554	97 BY 97 BY
26.5mm Reach 14mm Hex Projected Dual Fine Electrode Gasket, Solid													DILKAR7B8 DILKAR8A8 DF8H-11B	92217 93026 90174	324 JD 324 JD 324 JD
26.5mm Reach 14mm Hex Projected Gasket, Solid													ILKAR8H6	96024	339 KO
26.5mm Reach 14mm Hex Projected Wide Gap Gasket, Stud													LKAR8BI9 LKAR9BI9 LKAR9BI-10	1553 6205 95371	339 KO 339 KO 339 KO
26.5mm Reach 14mm Hex Projected Wide Gap Gasket, Solid				LKAR8A-9	4786	157 DS				LKR6BGP-E LKAR6AGP LKAR7AGP-D LKAR7BGP-S	96002 95830 93220 92649	180 KM 180 KM 180 KM 180 KM	ILKAR6C10 LKAR6AIX-11 ILKAR7B11 ILKAR7C10 ILKAR7L11 LKAR7BIX-11S LKAR8AI-9	95843 91187 4912 94940 94124 93501 6706	356 KL 30 V 357 KM 356 KL 356 KK TBD 339 JQ
26.5mm Reach 14mm Hex Extended Shell Projected Gasket, Solid													SILZKAR7E8S	93476	180 JM
26.5mm Reach 14mm Hex Extended Shell Extended Projection Gasket, Solid													SILZKFR8D7S SILZKFR8E7S	95875 90654	384 LN 384 LN
26.5mm Reach 14mm Hex Extended Shell Extended Projection Wide Gap Dual Fine Electrode Gasket, Solid													DF6H-11A	94702	390 LV
26.5mm Reach 14mm Hex Extended Projection Wide Gap Gasket, Solid										PLZKAR6A-11	5118	180 EM	ILZKAR7A10 ILZKAR7B11	6043 1654	228 GG 18 Q
26.5mm Reach 14mm Hex Extended Projection PSPE, Wide Gap Gasket, Solid													SILZKAR7B11	93482	369 KY
26.5mm Reach 14mm Hex Projected Wide Gap Dual Fine Electrode Gasket, Solid													DILKAR6A11 DILKAR7G11GS DILKAR7H11GS	9029 91578 96964	324 JD 353 KG 353 KG







# NGK Spark Plug Specification Chart

THE IGNITION SPECIALIST™

Spark Plug charts are sorted by thread size, thread reach, hex size. Hotter plugs are listed above the colder plugs. Plug images are located on the opposite page.

	STD. NON-RESISTOR			STD. RESISTOR			V-POWER			PLATINUM			IRIDIUM				
	Part No.	Stk No.	Image	Part No.	Stk No.	Image	Part No.	Stk No.	Image	Part No.	Stk No.	Image	Part No.	Stk No.	Image		
<b>12mm Spark Plugs cont'd</b>																	
26.5mm Reach Bi-Hex 14mm Extended Projection Gasket, Solid												PLZKBR7B8DG	90223	224 GE	ILZKBR7B8DG SILZKBR8D8S	95770 97506	224 GE 224 JM
26.5mm Reach Bi-Hex 14mm Extended Projection Gasket, Special Terminal															SILZKGR8B8S SILZKGR8C8S	94201 95248	392 LW 393 LX
26.5mm Reach 5/8" Hex Projected Gasket, Solid				LKR6E LKR7B-9 LKR7E	92650 5847 1643	326 JE 326 JE 326 JE				PLKR6A PLKR7A PLKR7B8E LKR7BGP-8	5149 4288 94716 95983	183 EP 183 EP 183 EP 291 LQ	LKR6CIX LKR7AIX ILKR7B8 ILKR7E6 ILKR8E6 SILKR8B8DS ILKR8Q7 ILKR9Q7G	93126 93911 1989 93053 1422 95705 93819 97312	186 ES 186 ES 328 JH 328 JH 325 JE 328 JH 328 JH		
26.5mm Reach 5/8" Hex Projected Wide Gap Gasket, Solid															LKR7BGP-S LKR7DIX-11S	97390 93175	291 LQ 359 LR
26.5mm Reach 5/8" Hex Projected Dual Fine Electrode Gasket, Solid															DILKR7B6 DILKR8B6	96957 91448	353 KH 353 KH
26.5mm Reach 5/8" Hex Projected, Wide Gap Dual Fine Electrode Gasket, Solid															DILKR6D11G DILKR7A11	95264 93135	353 JD 353 JD
26.5mm Reach 5/8" Hex Extended Projection Gasket, Solid				LZKAR7A	6799	331 JK				LZKR6AGP-E	94017	389 LU	LZKR6AIX SILZKR6B11 SILZKR6B10E SILZKR7E8EG SILZKR7E9G SILZKR7B11 SILZKR7E11 SILKR8A-S	92873 6215 93815 93655 91467 9723 92315 1402	325 JM 333 JM 333 JM 325 JM 325 JM 325 JM 333 JM 325 JE		
26.5mm Reach 5/8" Hex Extended Projected Extended Shell Gasket, Solid															ILZKR7A ILZKR8A ILZKAR8H8S ILZKAR8J8SY	1961 94290 95112 95660	20 S 20 S 20 S 20 S
26.5mm Reach 5/8" Hex Extended Projection Wide Gap Gasket, Solid															DILZKAR7B11 ILZKR7B11 ILZKR7B-11S	90935 7751 5787	324 KH 306 IP 306 IP
26.5mm Reach 5/8" Hex Extended Projection Extended Shell, DFE Gasket, Solid, Wide Gap															DILZKR7A11G DILZKR711DS DILZKR7B11GS DILZKAR7C11S DILZKAR7B11G	92924 90074 95710 90137 95350	354 KI 354 KI 354 KI 354 KI 354 KI
26.5mm Reach 5/8" Hex Projected 2-Ground Electrode Gasket, Solid				LKR8A	5214	185 ER				LKR8AP	4471	137 ER					
28.5mm Reach 14mm Hex Projected Dual Fine Electrode Gasket, Solid															DILKAR7C9H	91215	324 JD

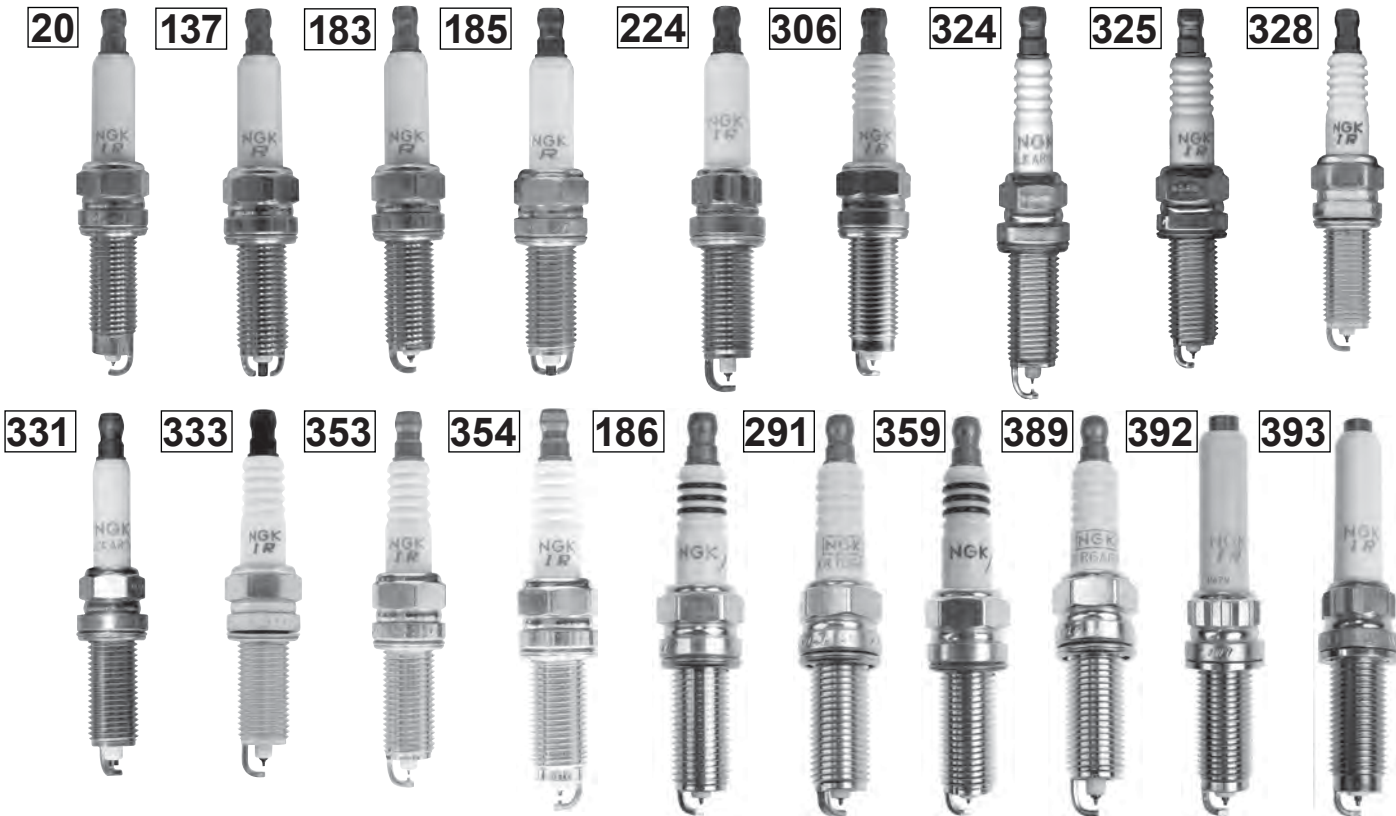



# NGK Spark Plug Specification Chart

THE IGNITION SPECIALIST™

Spark Plug charts are sorted by thread size, thread reach, hex size. Hotter plugs are listed above the colder plugs. Plug images are located on the opposite page.

	STD. NON-RESISTOR			STD. RESISTOR			V-POWER			PLATINUM			IRIDIUM		
	Part No.	Stk No.	Image	Part No.	Stk No.	Image	Part No.	Stk No.	Image	Part No.	Stk No.	Image	Part No.	Stk No.	Image
<b>14mm Spark Plugs</b>															
3/8" Reach 5/8" Hex Compact Tapered, Loose	BM6F	6221	241 GR				BM6FY BL1	2967	241 GR						
3/8" Reach 5/8" Hex Compact, Projected Tapered, Loose				BPMR6F	1270	11 GA									
3/8" Reach 5/8" Hex Compact, Projected Tapered, Solid	BPM6F	5950	220 GA												
3/8" Reach 3/4" Hex Compact Gasket, Loose	BM4A BM6A BM7A	5628 5921 6521	219 BI 219 BI 219 BI	BMR2A BMR4A BMR6A BMR7A	7677 5728 7421 4226	288 BI 288 BI 288 BI 288 BI	BM4Y BL1 BM6Y BL1 BM7Y BL1	4739 5466 3147	219 BI 219 BI 219 BI						
3/8" Reach 3/4" Hex Compact Gasket, Solid	BM4A SOLID BM6A SOLID	4000 6021	114 BI 114 BI	BMR2A SOLID BMR4A SOLID BMR6A SOLID	4013 4004 4002	117 BI 117 BI 117 BI									
3/8" Reach 3/4" Hex Compact, Wide Gap Gasket, Loose				BMR2A-10	4452	302 BI									
3/8" Reach 3/4" Hex Compact, Projected Gasket, Loose	BPM4A BPM6A BPM7A	5928 7021 7321	272 HP 272 HP 272 HP	BPMR6A BPMR7A	6726 4626	227 HP 227 HP	BPM6Y BPM7Y BPM7Y BL1	4562 4921 2101	139 DC 139 DC 139 DC						
3/8" Reach 3/4" Hex Compact, Projected Gasket, Solid	BPM7A SOLID	7472	292 IF	BPMR4A SOLID BPMR7A SOLID	5113 6703	256 HP 256 HP	BPMR6Y BL1 BPMR7Y BPMR8Y BPM8Y SOLID	5414 1589 2218 5574	139 DC 139 DC 139 DC 139 DC						
3/8" Reach 3/4" Hex Compact, Projected Wide Gap Gasket, Solid	BPM6A-10	6026	272 HP	BPMR4A-10 BPMR6A-10	6328 1029	227 HP 227 HP									
3/8" Reach 13/16" Hex Gasket, Loose	B-2 B-4 B6S B7S B8S	3110 3210 3510 3710 3810	65 AY 65 AY 65 AY 65 AY 65 AY	BR6S	3522	86 AY									
3/8" Reach 13/16" Hex Compact Gasket, Loose	B2-LM B4-LM	1147 3410	4 BI 4 BI	BR2-LM BR4-LM	5798 4133	210 BI 210 BI	B2LMY BL1 B4LMY BL1	4146 6150	4 BI 4 BI						
3/8" Reach 13/16" Hex Compact Gasket, Solid				BR2-LM SOLID	3841	106 BI									
3/8" Reach 13/16" Hex Projected Gasket, Solid							XR4 XR5	5858 3332	214 DC 214 DC			XR4IX XR5IX	7189 7355	283 HZ 283 HZ	
3/8" Reach 13/16" Hex Projected, Wide Gap Gasket, Solid							XR45	4536	214 DC			XR45IX	7293	283 HZ	
7/16" Reach 13/16" Hex Gasket, Loose	B4-L B6-L	3112 3212	66 AZ 66 AZ				B6LY BL1	7612	66 BI						

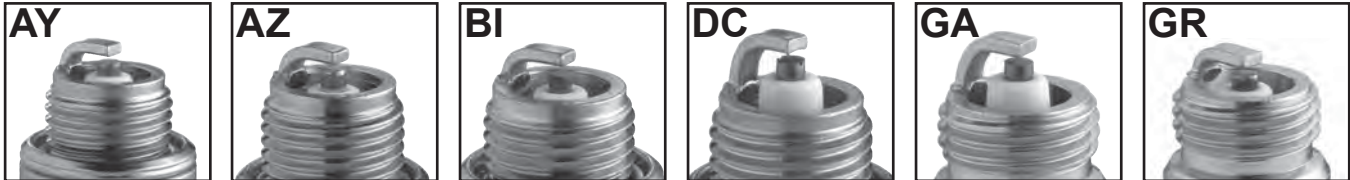
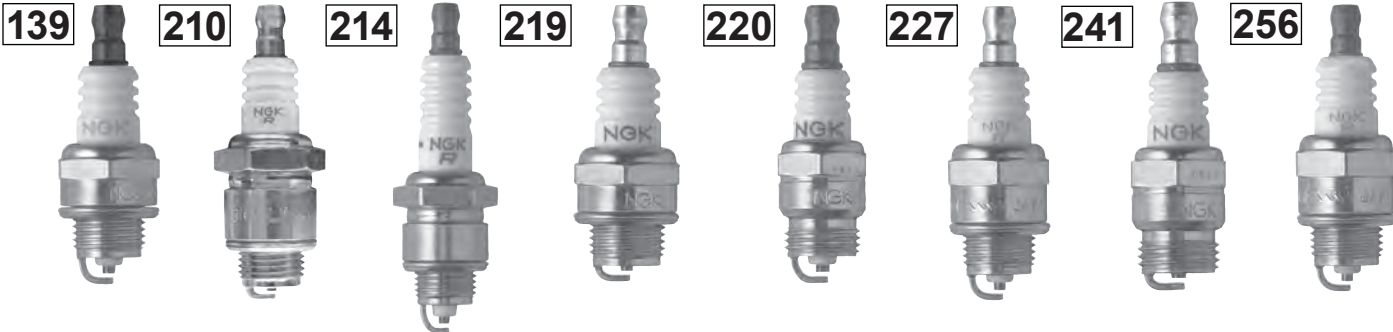
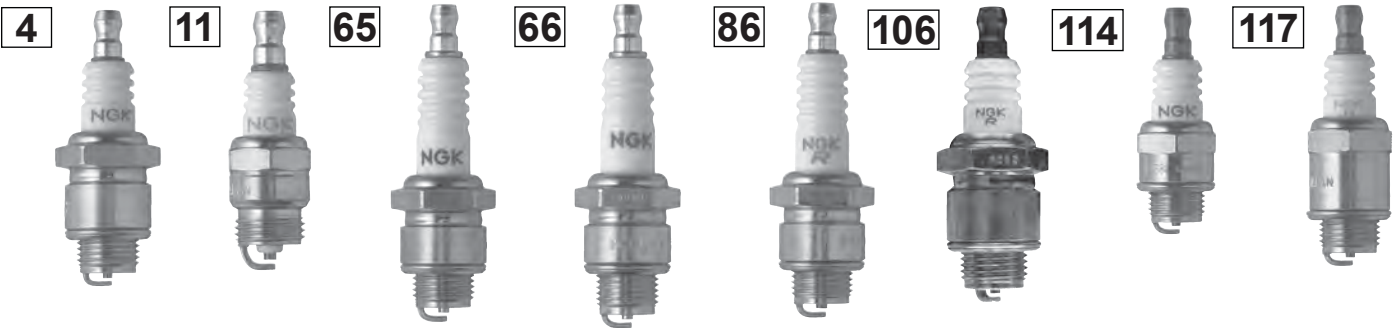



# NGK Spark Plug Specification Chart

THE IGNITION SPECIALIST™

Spark Plug charts are sorted by thread size, thread reach, hex size. Hotter plugs are listed above the colder plugs. Plug images are located on the opposite page.

	STD. NON-RESISTOR			STD. RESISTOR			V-POWER			PLATINUM			IRIDIUM		
	Part No.	Stk No.	Image	Part No.	Stk No.	Image	Part No.	Stk No.	Image	Part No.	Stk No.	Image	Part No.	Stk No.	Image
<b>14mm Spark Plugs cont'd</b>															
.460" Reach 5/8" Hex Tapered, Solid				BR6FS	4323	129 CS	YR5	7052	129 HQ	YR5GP	2953	59 AU	YR5IX BR6FIX	7516 2318	299 IJ 38 AB
.460" Reach 5/8" Hex Wide Gap Tapered, Solid							YR55	7240	129 HQ				YR55IX	7588	299 IJ
.460" Reach 5/8" Hex Projected Tapered, Solid				BPR6FS	2623	47 AJ	UR4 UR5 UR6	6630 2771 7773	47 HB 47 HB 47 HB	UR4GP UR5GP UR6GP	2869 3547 7966	72 BC 72 BC 72 BC	UR4IX UR5IX UR6IX	7401 7177 7348	297 IH 297 IH 297 IH
.460" Reach 5/8" Hex Projected, Wide Gap Tapered, Solid							UR45 UR55	6945 2248	47 HB 47 HB	UR45GP	3207	72 BC	UR45IX UR55IX	7559 7272	297 IH 297 IH
1/2" Reach 13/16" Hex Gasket, Stud				BR6HSA BR8HSA	4296 5539	126 CP 126 CP									
1/2" Reach 13/16" Hex Gasket, Loose	B4H B5HS B6HS B7HS B8HS B9HS B10HS	4110 4210 7534 5110 5510 5810 2399	43 AF 43 AF 43 AF 43 AF 43 AF 43 AF	BR4HS BR5HS BR6HS BR7HS BR8HS BR9HS	3322 3722 3922 4122 4322 4522	75 AF 75 AF 75 AF 75 AF 75 AF 75 AF							BR6HIX BR7HIX BR8HIX BR9HIX BR10HIX	3419 7067 7001 5687 6692	254 HD 254 HD 254 HD 254 HD 254 HD
1/2" Reach 13/16" Hex Gasket, Solid				BR8HS SOLID	6715	257 AF									
1/2" Reach 13/16" Hex Wide Gap Gasket, Loose	B6HS-10 B7HS-10 B8HS-10 B9HS-10	1052 2129 5126 3626	43 AF 43 AF 43 AF 43 AF	BR6HS-10 BR7HS-10 BR8HS-10 BR9HS-10	1090 1098 1134 4551	75 AF 75 AF 75 AF 75 AF									
1/2" Reach 13/16" Hex Inductive Resistor, Wide Gap Gasket, Solid				BZ7HS-10	3579	75 AF									
1/2" Reach 13/16" Hex Low Angle Ground Electrode Wide Gap Gasket, Loose				BR8HCS-10	1157	5 E									
1/2" Reach 13/16" Hex Projected Gasket, Loose	BP4HS BP5HS BP6HS BP7HS BP8HS	3611 4111 7331 5111 2630	90 BR 90 BR 90 BR 90 BR 90 BR	BPR4HS BPR5HS BPR6HS BPR7HS BPR8HS	7823 6222 7022 6422 3725	175 BR 175 BR 175 BR 175 BR 175 BR							BPR6HIX BPR7HIX BPR8HIX	4085 5944 6742	120 CI 120 CI 120 CI
1/2" Reach 13/16" Hex Projected Gasket, Stud				BPR6HSA	4632	142 DF									
1/2" Reach 13/16" Hex Projected, Wide Gap Gasket, Loose	BP4HS-10 BP6HS-10 BP7HS-10 BP8HS-10	5011 6326 7829 3823	90 BR 90 BR 90 BR 90 BR	BPR4HS-10 BPR6HS-10 BPR7HS-10	5024 2633 1092	175 BR 175 BR 175 BR									
1/2" Reach 13/16" Hex Projected, Wide Gap Inductive Resistor Gasket, Solid				BPZ8HS-10 BPZ8HS-15	3133 3180	175 BR 175 BR	BPZ8H-N-10	4495	175 BR						



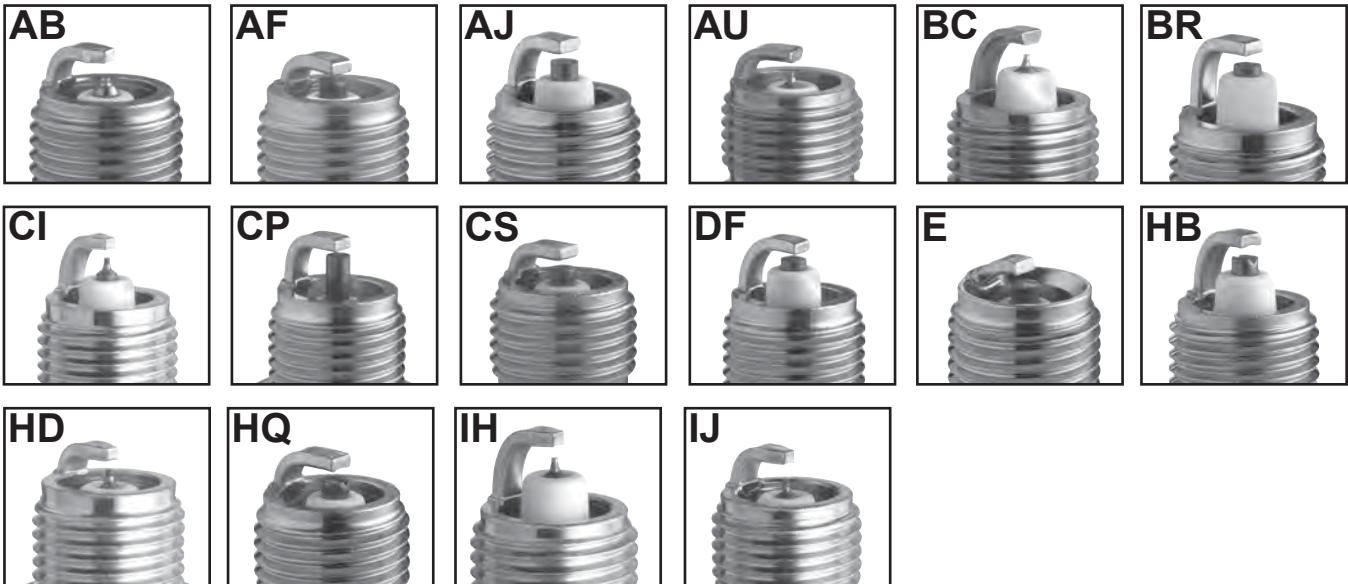
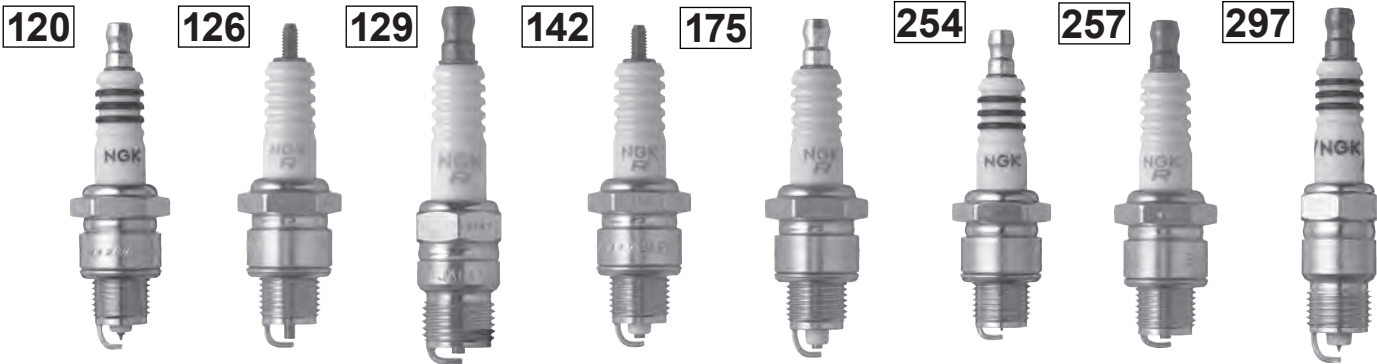



# NGK Spark Plug Specification Chart

THE IGNITION SPECIALIST™

Spark Plug charts are sorted by thread size, thread reach, hex size. Hotter plugs are listed above the colder plugs. Plug images are located on the opposite page.

	STD. NON-RESISTOR			STD. RESISTOR			V-POWER			PLATINUM			IRIDIUM		
	Part No.	Stk No.	Image	Part No.	Stk No.	Image	Part No.	Stk No.	Image	Part No.	Stk No.	Image	Part No.	Stk No.	Image
<b>14mm Spark Plugs cont'd</b>															
1/2" Reach 13/16" Hex Projected, Wide Gap Gasket, Solid	BP8HS-15	6729	258 BR				BP8H-N-10	4838	159 BR						
1/2" Reach 13/16" Hex Surface Discharge Gasket, Solid	BU8H BUH BUHX	6431 2422 2522	242 GS 242 AG 242 AG												
1/2" Reach 13/16" Hex Surface Discharge Inductive Resistor Gasket, Solid				BUZ8H	7447	290 GS									
1/2" Reach 13/16" Hex Tungsten Electrode Gasket, Solid	BUHW BUHW-2 BUHXW-1	2622 5626 5526	242 AG 242 FJ 242 FD												
1/2" Reach 13/16" Hex Tungsten Electrode Inductive Resistor Gasket, Solid				BUZHW BUZHW-2	2147 2173	290 AG 290 FJ									
.708" Reach 5/8" Hex Tapered, Loose	B8EFS B9EFS	1049 1085	1 A 1 A							ITR6G9	90156	138 DB			
.708" Reach 5/8" Hex Tapered, Solid				BR7EFS	1094	69 A	BR6EF BR7EF	3177 3346	69 BA 69 BA						
.708" Reach 5/8" Hex Projected Tapered, Loose	BP7EFS	3526	87 BN												
.708" Reach 5/8" Hex Projected Tapered, Solid				BPR6EFS	3623	91 BN	TR4 TR5 TR6	3754 2238 4177	98 IZ 98 IZ 98 IZ	TR4GP TR5GP TR6GP PTR5D-10	2815 3186 5141 3784	53 AP 53 AP 53 AP 182 EO	TR4IX TR5IX TR6IX TR7IX TR8IX	7300 7397 3689 3690 3691	284 IA 284 IA 284 IA 284 IA 284 IA
.708" Reach 5/8" Hex Projected, Wide Gap Tapered, Solid				BPR5EFS-13 TR5C-12	2359 92838	373 LC 373 LC				PTR4G-15 PTR5F-11 PTR5C-13 PTR5D-13 TR5BP12 TR55GP PTR6D-13 TR6AP-13E TR6AP-13	1209 6579 7740 6644 93858 3403 5598 4968 5809	7 G 182 EO 182 EO 182 EO 372 LB 53 AP 182 EO 374 LD 374 LD	ITR4A15 ITR5H13 TR5AI-13 TR55IX TR65IX ITR6F13	5599 97287 90813 7164 3692 4477	198 FI 138 DB 138 DB 284 IA 284 IA 138 DB
.708" Reach 5/8" Hex Extended Projection Wide Gap Tapered, Solid							TR55	3951	98 IZ	PZTR5A-15	7862	182 IY	IZTR4A11 IZTR5B11	4213 1465	122 CK 16 O

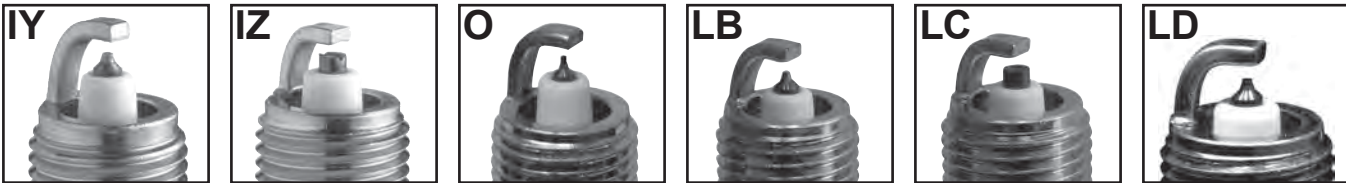
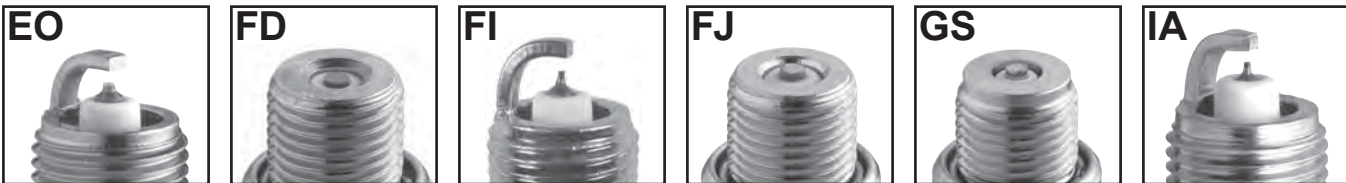
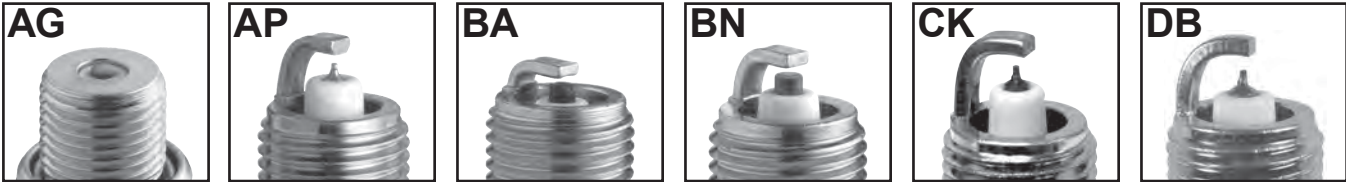
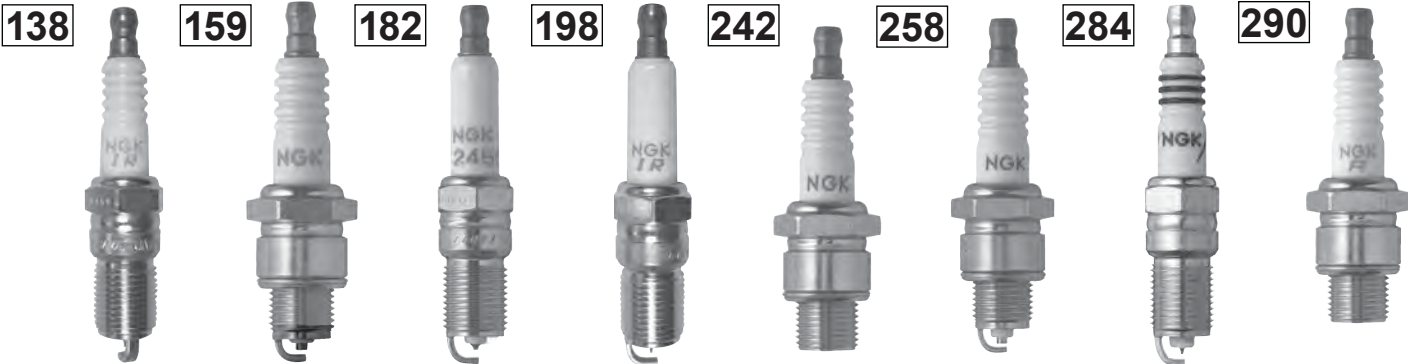



# NGK Spark Plug Specification Chart

THE IGNITION SPECIALIST™

Spark Plug charts are sorted by thread size, thread reach, hex size. Hotter plugs are listed above the colder plugs. Plug images are located on the opposite page.

	STD. NON-RESISTOR			STD. RESISTOR			V-POWER			PLATINUM			IRIDIUM		
	Part No.	Stk No.	Image	Part No.	Stk No.	Image	Part No.	Stk No.	Image	Part No.	Stk No.	Image	Part No.	Stk No.	Image
<b>14mm Spark Plugs cont'd</b>															
.708" Reach 5/8" Hex Projected Extended Shell Tapered, Solid							TR5-1	7060	274 HR	TR5-1GP	3716	96 BX	TR5-1IX	7243	281 HX
.708" Reach 5/8" Hex Projected Extended Shell Wide Gap Tapered, Solid							TR55-1	2683	274 HR	TR45-1GP TR55-1GP	5684 7159	96 BX 96 BX	TR45-1IX TR55-1IX	6744 7316	281 HX 281 HX
3/4" Reach 5/8" Hex ISO Projected BK-Series Gasket, Solid				BKR5ES	2460	13 C	BKR4E BKR5E BKR5EY BKR5EYA	4421 7938 7390 2087	13 L 13 L 13 J 13 J	BKR5EGP	7090	276 HS	BKR4EIX BKR5EIX	5693 6341	204 FO 204 FO
				BKR6ES	6364	13 C	BKR6E BKR6EY BKR6EYA BKR6EZB BKR7E BKR7E-E	6962 3696 7990 4293 4644 4776	13 L 13 J 13 J 13 L 13 L 13 L	BKR6EGP BKR6EP-8	7092 2215	276 HS 23 GO	BKR6EIX  BKR7EIX BKR8EIX BKR9EIX	6418  2667 2668 2669	204 FO  204 FO 204 FO 204 FO
3/4" Reach 5/8" Hex ISO Projected BK-Series Wide Gap Gasket, Solid				BKR4ESA-11 BKR5ES-11 BKR5ESA-11	7755 2382 5643	307 C 13 C 307 C	BKR4E-11 BKR5E-11	5424 6953	13 L 13 L	BKR5EP-11	3440	23 GO	BKR5EIX-11	5464	204 FO
				BKR6ES-11 BKR7ES-11	5553 4952	13 C 13 C	BKR5E-N-11 BKR5EY-11 BKR5EYA-11 BKR6E-11 BKR6E-N-11 BKR7E-11	2391 6745 2526 2756 5724 5791	13 L 13 J 13 J 13 L 13 L 13 L	BKR6EP-11	2978	23 GO	BKR6EIX-11 BKR7EIX-11	3764 6988	204 FO 204 FO
3/4" Reach 5/8" Hex ISO Projected FR-Series Gasket, Solid							FR4 FR5	5155 7373	13 J 13 J	FR4GP FR5GP	2685 3248	276 HS 276 HS			
										PFR6B PFR6G PFR6Q PFR7AB PFR7S8EG PFR7N8DS PFR7B PFR7Q PFR8S8EG	3500 4793 6458 93322 1675 93580 4853 7963 94460	189 EV 141 Y 141 Y 141 JG 327 JG 330 JJ 141 EV 141 Y 327 JG	IFR5T-8N FR5EI IFR6B IFR6Q-G IFR6B-K FR6EI IFR7F-4D IFR7F-8DS IFR7X7G	3508 1313 6507 5648 4867 2687 5115 5547 91039	335 JO 49 AL 336 JP 200 FK 160 DT 49 AL 179 EL 197 FH 336 JP

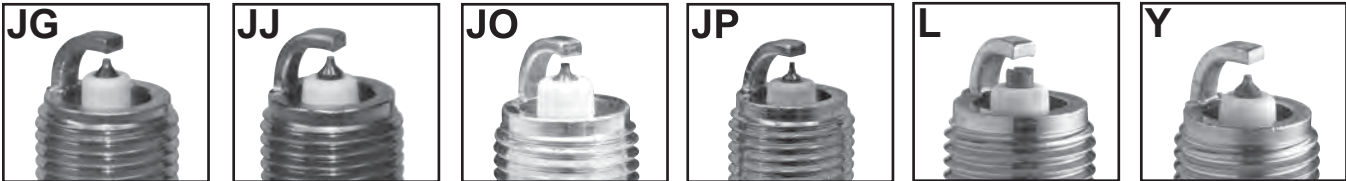
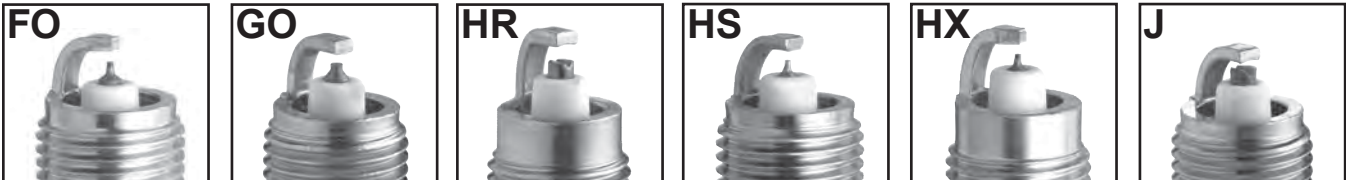
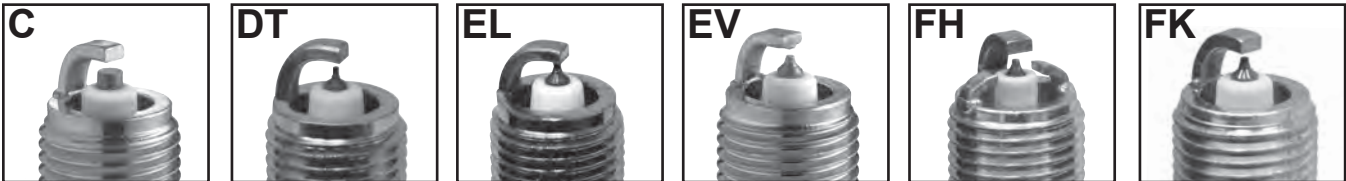
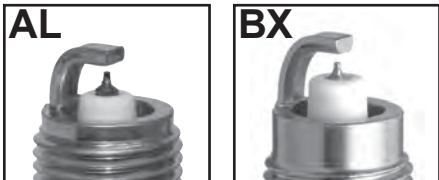
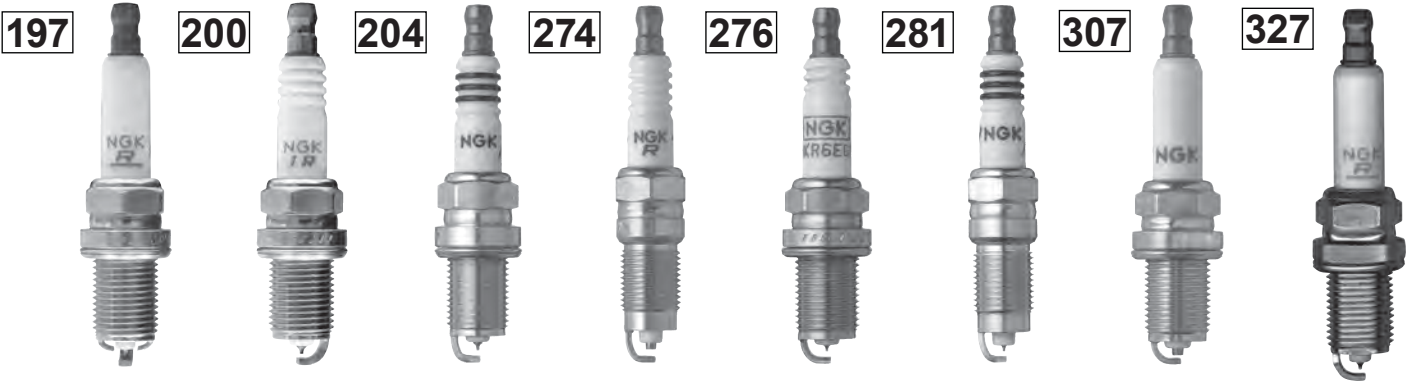
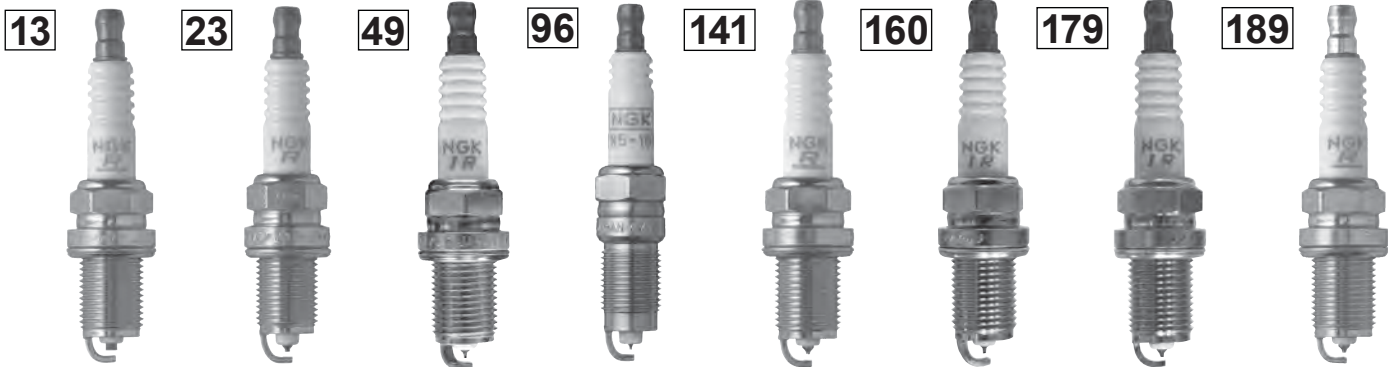





# NGK Spark Plug Specification Chart

THE IGNITION SPECIALIST™

Spark Plug charts are sorted by thread size, thread reach, hex size. Hotter plugs are listed above the colder plugs. Plug images are located on the opposite page.

	STD. NON-RESISTOR			STD. RESISTOR			V-POWER			PLATINUM			IRIDIUM		
	Part No.	Stk No.	Image	Part No.	Stk No.	Image	Part No.	Stk No.	Image	Part No.	Stk No.	Image	Part No.	Stk No.	Image
<b>14mm Spark Plugs cont'd</b>															
3/4" Reach 5/8" Hex ISO Projected Partial Thread FR - Series Gasket, Solid				FR2B-D	1598	334 JN									
3/4" Reach 5/8" Hex ISO Projected FR-Series Wide Gap Gasket, Solid							FR45	3686	13 J	FR45GP FR5AP-10 FR5AP-11 FR5AP-11E PFR5B-11 PFR5B-11B PFR5C-11 PFR5J-11 PFR5R-11 PFR5N-11 PFR5L-11  PFR5G-11 PFR5G-13E  PFR6B-11  PFR6T-10G PFR6U-11G PFR6G-11 PFR6G-13 PFR6L-13  PFR6G-13E PFR6L-11 PFR6J-11 PFR6N-11  PFR6X-11 PFR7G-11 PFR7G-11S	3072 6371 5463 6569 2300 2867 2271 4642 4292 5838 5459  2647 2761  4014  5542 5874 5555 4115 3141  2341 4639 2743 3546  5757 2380 7772	276 HS 238 GO 238 GO 276 HS 141 EV 55 AR 141 Y 141 DG 125 CO 141 FU 141 FA  141 Y 141 Y  141 EV  195 FE 216 FX 141 Y 141 Y 141 DG  141 Y 141 FA 141 DG 141 FU  141 Y 42 AE 141 Y	IFR5D10 IFR5N10 IFR5J11 IFR5G11 IFR5G-11K IFR5E11 IFR5L11 IFR5T11   IFR6B11 IFR6D10 IFR6E11 IFR6T11 IFR6G-11K IFR6L11 IFR6J11 IFR6V-10G  IFR7G-11KS IFR7L11 IFR8H11 IFR9H11  FR9BI-11	4696 7866 7418 7854 3107 7994 6502 4996   5368 5344 6741 4589 1314 3678 7658 92085  7746 5114 5068 6588  4709	151 DM 313 BW 151 DM 151 DM 63 AW 151 DM 63 AW 151 DM   151 DM 151 DM 151 DM 151 DM 151 DM 151 DM 151 DM 151 DM 151 DM 151 DM 151 DM 151 DM 151 DM 151 DM 151 DM
3/4" Reach 5/8" Hex ISO Projected PSPE Wide Gap Gasket, Solid													SIFR6A11	127	365 KU
3/4" Reach 5/8" Hex ISO Extended Projection Gasket, Solid							ZFR5N	3459	82 BJ	ZFR5FGP ZFR5AP	7098 92041	278 HU 42 IY	IZFR5B	4080	119 CH

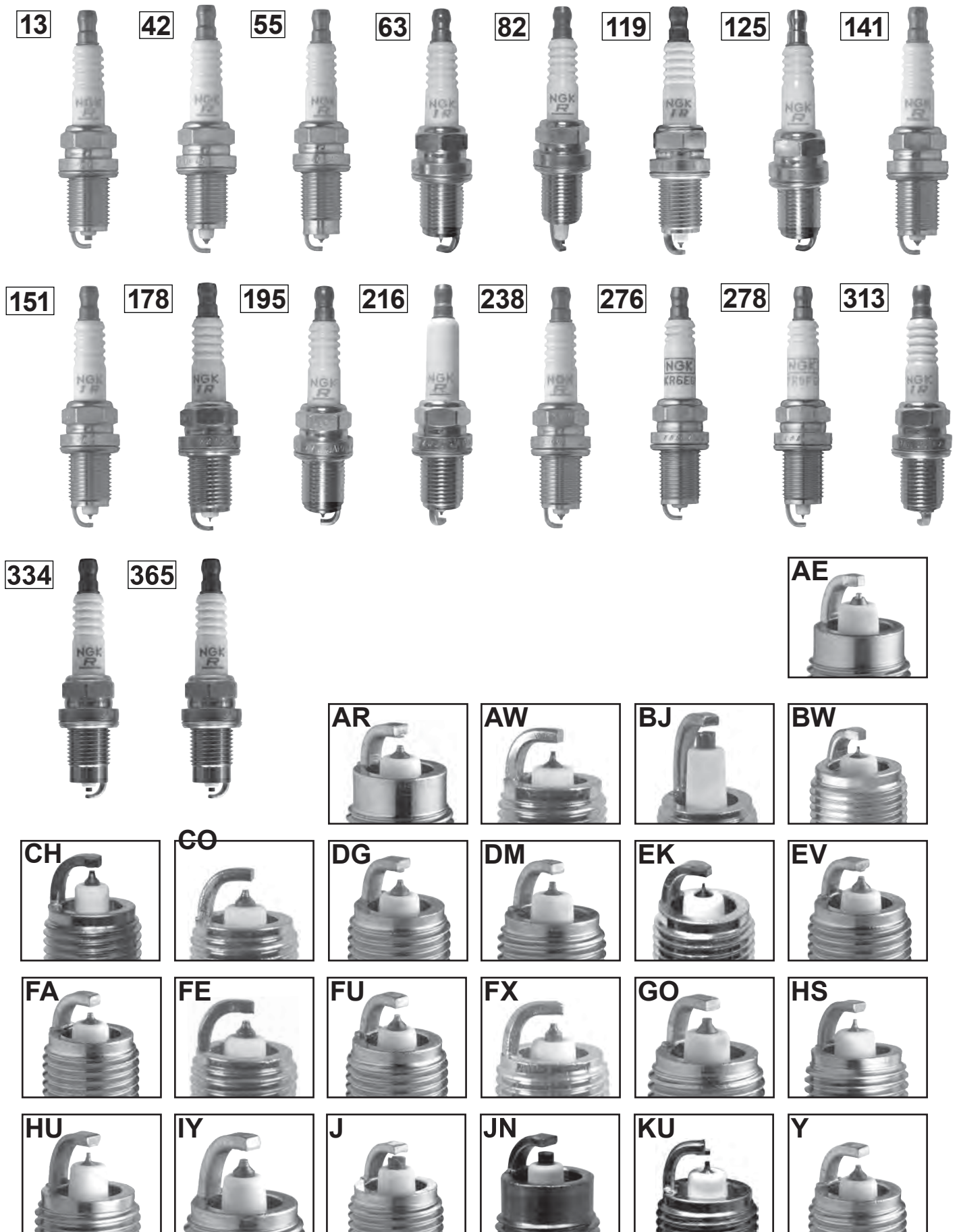



# NGK Spark Plug Specification Chart

THE IGNITION SPECIALIST™

Spark Plug charts are sorted by thread size, thread reach, hex size. Hotter plugs are listed above the colder plugs. Plug images are located on the opposite page.

	STD. NON-RESISTOR			STD. RESISTOR			V-POWER			PLATINUM			IRIDIUM			
	Part No.	Stk No.	Image	Part No.	Stk No.	Image	Part No.	Stk No.	Image	Part No.	Stk No.	Image	Part No.	Stk No.	Image	
<b>14mm Spark Plugs cont'd</b>																
3/4" Reach 5/8" Hex ISO Extended Projection Gasket, Solid							ZFR5F-4 ZFR5F	96830 7558	184 EQ 184 EQ		ZFR5BGP ZFR5EGP ZFR5FGP-8E ZFR5FGP-E PZFR5F PZFR6F ZFR6BGP-S ZFR6FGP PZFR6H ZFR7F	90804 7096 92459 94407 3741 6876 92213 7100 7696 4253	277 HT 277 HT 278 HU 278 HU 42 IY 42 IY 278 HU 278 HU 42 IY 42 IY	IZFR5B IZFR5J  IZFR5G ZFR5FIX-E IZFR6J IZFR6N-E IZFR6Q IZFR7M	4080 5899  5887 95332 4462 4757 91234 4214	119 CH 218 FZ  218 FZ 218 FZ 135 CY 155 DQ 135 CY 123 CL
3/4" Reach 5/8" Hex ISO Extended Projection Wide Gap Gasket, Solid							ZFR4F-11 ZFR5A-11 ZFR5D-11 ZFR5E-11 ZFR5F-11 ZFR5J-11 ZFR6A-11 ZFR6F-11 ZFR6F-11G ZFR6J-11 ZFR6U-9 ZFR6K-9E ZFR7F-11	4043 5084 4936 4435 2262 5584 1041 4291 6987 5585 90318 92566 6855	184 EQ 184 EQ 167 EA 167 CU 184 EQ 184 FF 184 EQ 184 EQ 184 EQ 184 FF 184 FF 184 FF 184 EQ	PZFR5D-11  PZFR5F-11 ZFR5LP-13G PZFR5J-11 PZFR5Q-11 ZFR6AGP  PZFR6E-11 PZFR6F-11  PZFR6J-11	7968  4363 7781 7743 6737 7094  7790 3271  3586	42 IY  42 IY 42 IY 305 IO 305 IO 278 HU  42 AE 42 IY  305 IO	ZFR5AIX-11 ZFR5FIX-11 ZFR5FIX-11E  IZFR5K11 IZFR5L11 IZFR6F11 IZFR6H11 ZFR6FIX-11 ZFR6AIX-11S IZFR6K-11S IZFR6K11 IZFR6K-11E IZFR6K13	94553 2477 96807  3657 97932 4095 4294 6441 97138 5266 6994 6748 6774	270 HO 270 HO 218 FZ 218 FZ 218 FZ 218 FZ 218 FZ 270 HO 270 HO 270 HO 270 HO 270 HO	
3/4" Reach 5/8" Hex ISO Extended Projection Extended Shell Projection Gasket, Solid							FR5-1	7252	282 HY							
3/4" Reach 5/8" Hex ISO Projected 2-Ground Electrode Gasket, Solid				BKR5EK BKR6EK BKR6EKC BKR7EKC-N	7797 2288 4959 2095	318 IW 318 IW 54 AQ 54 AQ										
3/4" Reach 5/8" Hex ISO Projected 2-Ground Electrode Wide gap Gasket, Solid				BKR5EKB-11	3967	110 CG				BKR5EKP-11 BKR6EKP-11	4302 3452	127 CQ 127 CQ				

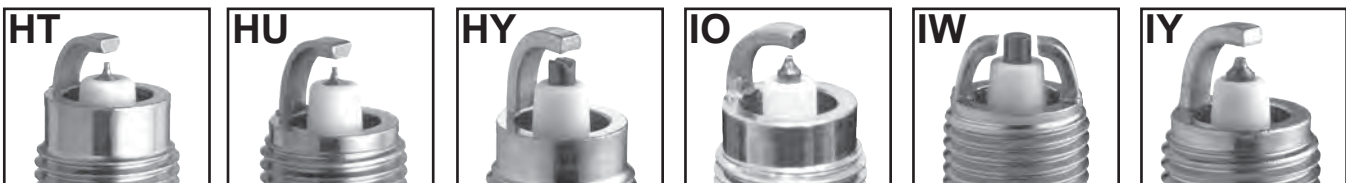
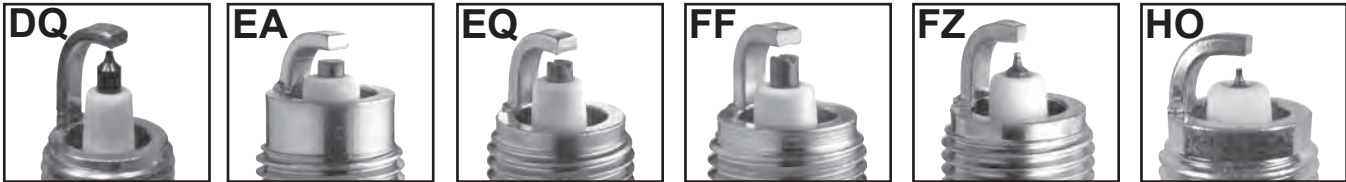
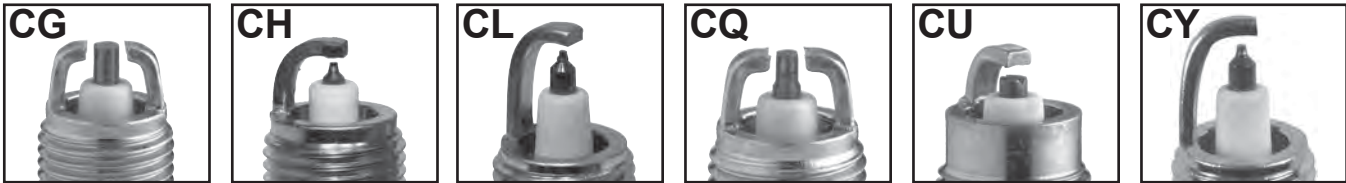
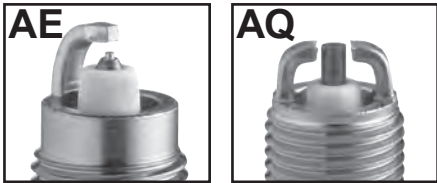
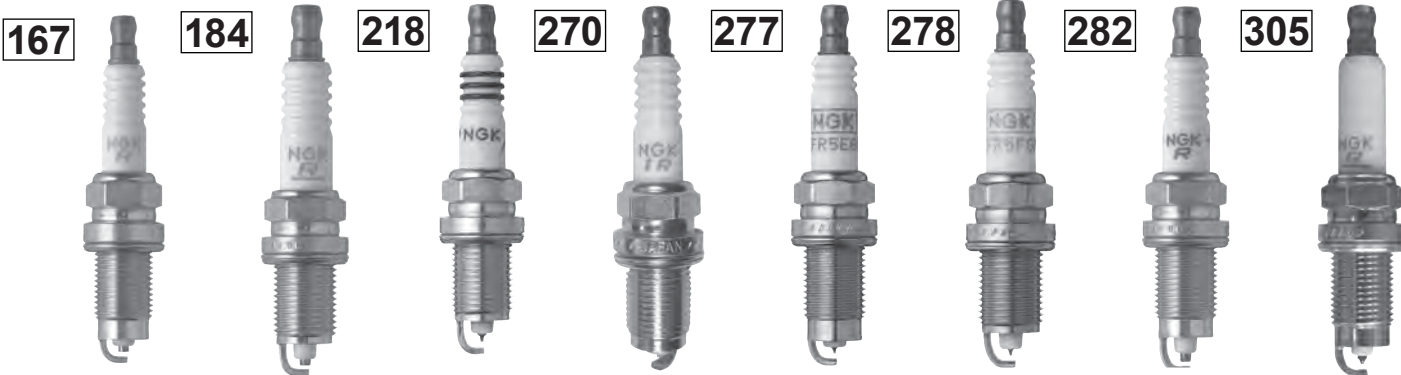
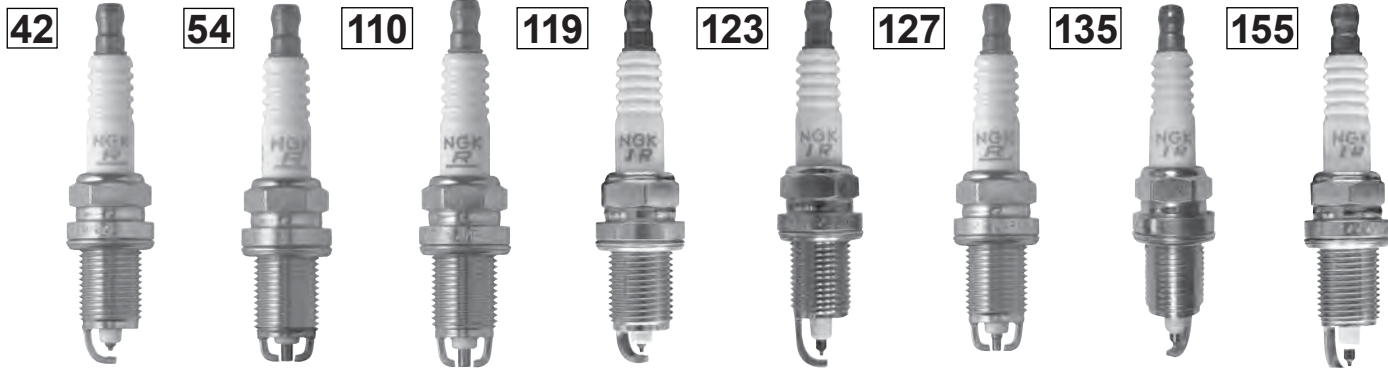



# NGK Spark Plug Specification Chart

THE IGNITION SPECIALIST™

Spark Plug charts are sorted by thread size, thread reach, hex size. Hotter plugs are listed above the colder plugs. Plug images are located on the opposite page.

	STD. NON-RESISTOR			STD. RESISTOR			V-POWER			PLATINUM			IRIDIUM		
	Part No.	Stk No.	Image	Part No.	Stk No.	Image	Part No.	Stk No.	Image	Part No.	Stk No.	Image	Part No.	Stk No.	Image
<b>14mm Spark Plugs cont'd</b>															
3/4" Reach 5/8" Hex ISO Projected Semi-Surface Discharge Gasket, Solid				BKR5EKU BKR6EKU BKR6EKUE BKR6EKUB BKR7EKU	3964 6993 7892 7969 5881	109 FM 109 FM 109 FM 88 BP 109 FM				BKR5EKUP	2890	57 AS			
3/4" Reach 5/8" Hex ISO Projected 2-Ground Electrode Gasket, Loose				BKR6EKE	5649	201 FL									
3/4" Reach 5/8" Hex ISO Projected Dual Fine Electrode Wide Gap Gasket, Solid													DIFR5C11 DIFR6C11 DIFR6D13	1311 1312 94167	337 KD 337 KD 337 KD
3/4" Reach 5/8" Hex 3-Ground Electrode Gasket, Solid				BKUR6ETB BKUR6ET BKUR6ET-10 BKUR7ET	6992 7808 2397 7873	243 GT 243 GT 243 GT 243 GT				PFR6W-TG PFR7W-TG	5547 5592	197 FH 197 FH			
3/4" Reach 5/8" Hex 4-Ground Electrode Gasket, Solid				BKR6EQUA	5767	263 HJ				BKR6EQUA BKR7EQUA	3199 4285	70 BB 70 BB			
3/4" Reach 5/8" Hex JIS Projected Gasket, Solid	BCP5ES BCP6ES BCP7ES	7496 4930 5030	294 C 294 C 294 C	BCPR5ES BCPR6ES BCPR7ES	6130 2330 6282	230 C 230 C 230 C	BCPR5EY BCPR6E	1266 3735	13 J 13 L	BCPR5EP-8 BCPR5EGP BCPR6EGP	2950 7086 7088	23 GO 276 HS 276 HS	BCPR5EIX BCPR6EIX BCPR7EIX	5688 5689 5690	204 FO 204 FO 204 FO
3/4" Reach 5/8" Hex JIS Projected Wide Gap Gasket, Solid	BCP4ES-11 BCP6ES-11	1086 7210	3 C 3 C	BCPR5ES-11 BCPR6ES-11	6696 6779	13 C 13 C	BCPR5E-11 BCPR5EY-11 BCPR6E-11 BCPR6EY-11	1273 2441 5632 3720	13 L 13 J 13 L 13 J	BCPR5EP-11 PFR5A-11 BCPR6EP-11	2097 4588 3350	23 GO 141 DE 23 GO	BCPR5EIX-11 BCPR6EIX-11	3306 4919	204 FO 204 FO
3/4" Reach 5/8" Hex JIS Projected Wide Gap Gasket, Solid				BCPR7ES-11	1095	13 C	BCPR6EY-N-11 BCPR7EY-11	6262 1271	13 J 12 K	PFR6H-10 PFR6A-11 BCPR6EP-N-11 BCPR6EP-N-8 PFR7H-10	6290 4045 4497 5275 3978	141 Y 141 DE 23 GO 23 GO 141 Y	BCPR7EIX-11	5691	204 FO
3/4" Reach 5/8" Hex 3-Ground Electrode JIS Projected Gasket, Loose	BCP6ET	4563	140 DD	BCPR7ET	5509	29 DD									



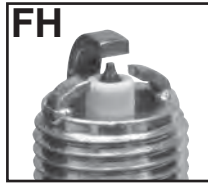
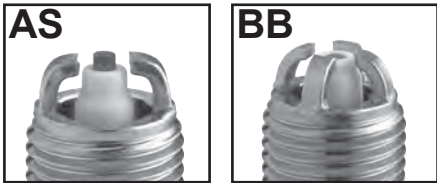
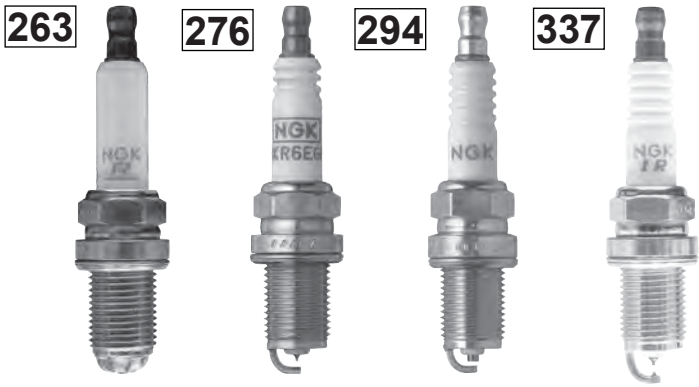
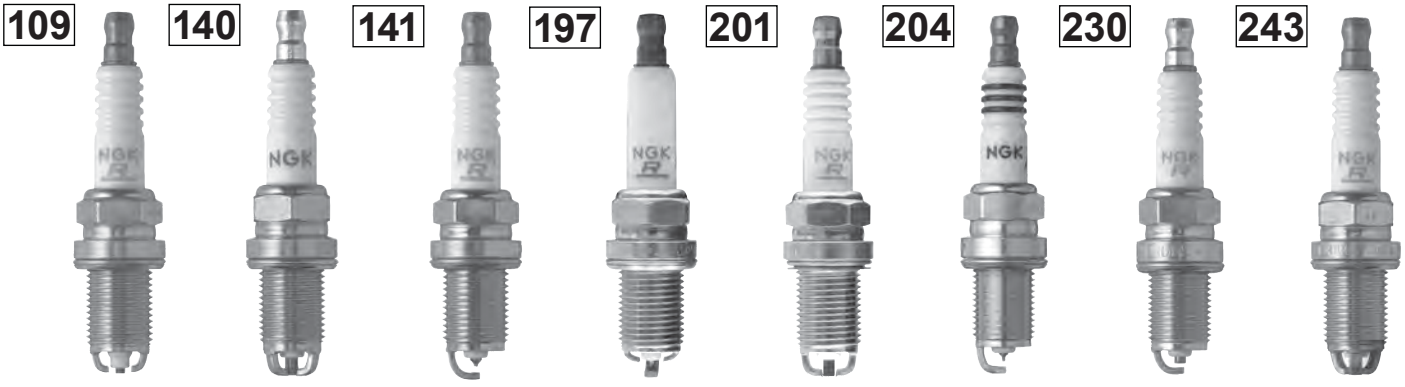
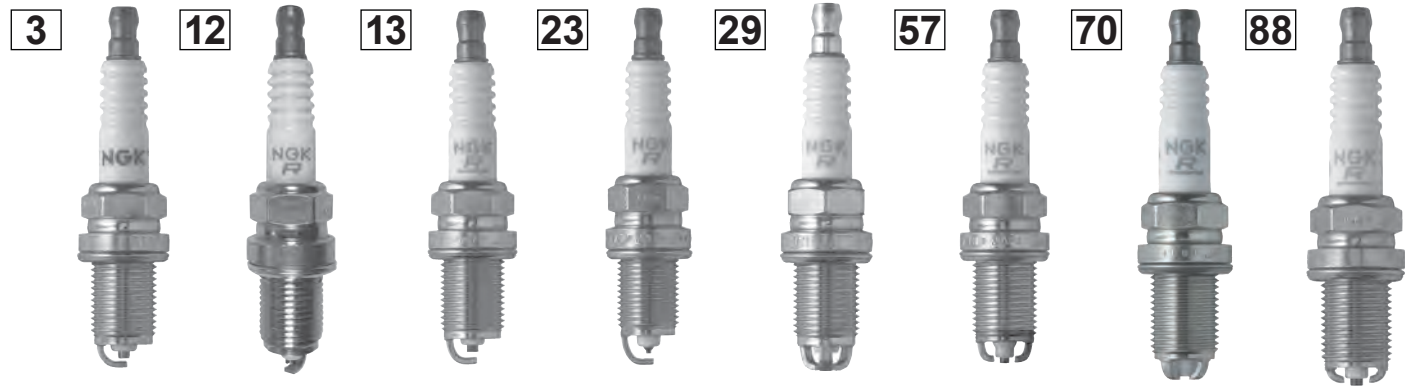



# NGK Spark Plug Specification Chart

THE IGNITION SPECIALIST™

Spark Plug charts are sorted by thread size, thread reach, hex size. Hotter plugs are listed above the colder plugs. Plug images are located on the opposite page.

	STD. NON-RESISTOR			STD. RESISTOR			V-POWER			PLATINUM			IRIDIUM		
	Part No.	Stk No.	Image	Part No.	Stk No.	Image	Part No.	Stk No.	Image	Part No.	Stk No.	Image	Part No.	Stk No.	Image
<b>14mm Spark Plugs cont'd</b>															
3/4" Reach 13/16" Hex Gasket, Loose	B4ES	4129	317 IV	BR4ES	1097	158 IV									
	B5ES	6410	317 IV	BR5ES	5866	158 IV									
	B6ES	7432	317 IV	BR6ES	4922	158 IV									
	B7ES	1111	317 IV	BR7ES	5122	158 IV							BR7EIX	6664	260 HG
	B8ES	2411	317 IV	BR8ES	5422	158 IV							BR8EIX	5044	260 HG
	B9ES	2611	317 IV	BR9ES	5722	158 IV							BR9EIX	3981	260 HG
	B10ES	7928	317 IV	BR10ES	4832	158 IV							BR10EIX	6801	260 HG
3/4" Reach 13/16" Hex Gasket, Solid	B7ES SOLID	2877	315 IV	BR7ES SOLID	6615	147 IV							IGR7A-G	3106	62 AV
	B8ES SOLID	3683	315 IV	BR8ES SOLID	3961	147 IV							BR8EIX SOLID	6747	268 HG
	B9ES SOLID	7148	315 IV	BR9ES SOLID	3194	147 IV	BR9EYA	7548	301 IL				BR9EIX SOLID	3089	268 HG
				BR10ES SOLID	4684	147 IV	BR10EYA	7613	301 IL				BR10EIX SOLID	6957	268 HG
3/4" Reach 13/16" Hex Wide Gap Gasket, Solid	B6ES-11	7910	315 IV	BR6ES-11	3824	147 IV	BR6EB-L-11	6931	147 IV						
	B7ES-11	2311	315 IV	BR8ES-11	7986	147 IV									
3/4" Reach 13/16" Hex Compact Gasket, Solid				BR8ECM	3035	61 FY							BR8ECMIX	3520	52 AO
				BR9ECM	3252	61 FY							BR9ECMIX	2707	52 AO
				BR10ECM	4234	61 FY							BR10ECMIX	3006	52 AO
3/4" Reach 13/16" Hex Projected Gasket, Loose	BP5ES	7832	267 C	BPR2ES	2264	34 C							GR4IX	97382	250 FO
				BPR5ES	7734	34 C	BP5EY	7327	311 J	BPR5EGP	7082	275 HS	BPR5EIX	6597	250 FO
	BP6ES	7333	267 C	BPR6ES	7131	34 C	BPR5EY BL1	3664	34 J				BPR6EIX	6637	250 FO
	BP7ES	1034	267 C	BPR7ES	5534	34 C	BPR6EY BL1	2489	34 J	BPR6EGP	7084	275 HS	BPR7EIX	4055	250 FO
	BP8ES	2912	267 C	BPR8ES	3923	34 C							BPR8EIX	6684	250 FO
	BP9ES	7526	267 C									BPR9EIX	6853	250 FO	
												BPR10EIX	95236	250 FO	
3/4" Reach 13/16" Hex Projected Gasket, Solid				BPR2ES SOLID	2015	22 C									
				BPR4ES SOLID	6578	22 C	BPR4EY GR4	3432	22 J						
	BP5EA-L	7834	311 IS							GR4GP	2763	68 HS			
	BP5ES SOLID	2140	27 C	BPR5ES SOLID	4006	22 C	BPR5EY GR5	1233	22 J						
							BP6EY	2851	22 J	GR5GP	3351	68 HS	GR5IX	7214	25 FO
							BPR6EY	7727	311 J						
	BP6ES SOLID	4007	27 C	BPR6ES SOLID	4008	22 C				PGR6A	4984	14 GL			
	BP7ES SOLID	3995	27 C	BPR7ES SOLID	3785	99 BZ				PGR7A	3200	14 GL			
	BP8ES SOLID	3994	27 C	GR9A-EG	94841	355 KJ									
				BPR9ES	7788	22 C									

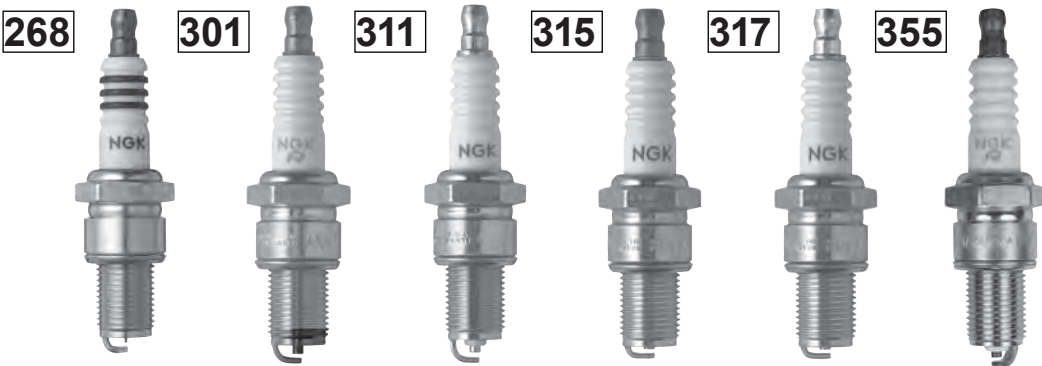
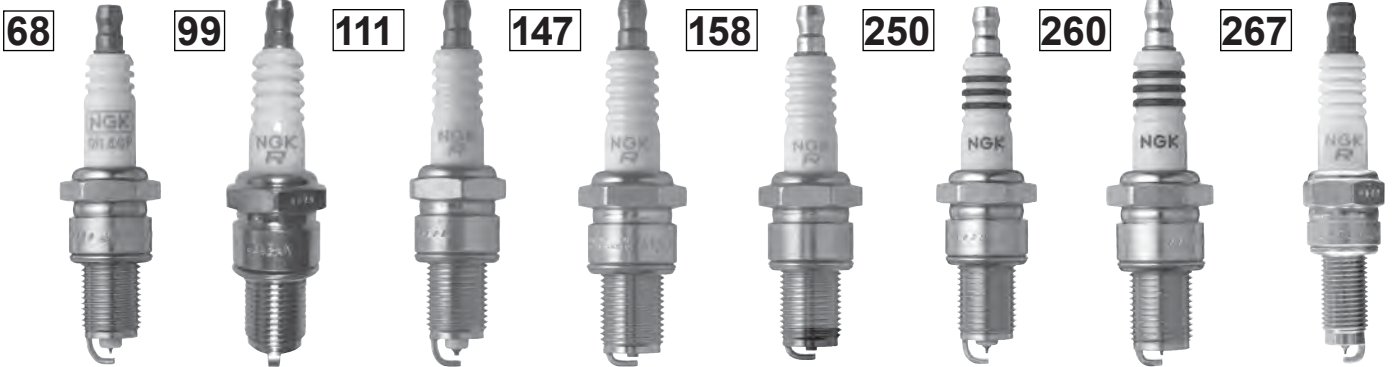



# NGK Spark Plug Specification Chart

THE IGNITION SPECIALIST™

Spark Plug charts are sorted by thread size, thread reach, hex size. Hotter plugs are listed above the colder plugs. Plug images are located on the opposite page.

	STD. NON-RESISTOR			STD. RESISTOR			V-POWER			PLATINUM			IRIDIUM		
	Part No.	Stk No.	Image	Part No.	Stk No.	Image	Part No.	Stk No.	Image	Part No.	Stk No.	Image	Part No.	Stk No.	Image
<b>14mm Spark Plugs cont'd</b>															
3/4" Reach Extended Thread Shell 13/16" Hex Projected Gasket, Solid				BPR4ES-H	1671	237 JN									
3/4" Reach 13/16" Hex Projected, Wide Gap Gasket, Solid	BP5ES-11	7732	27 C	BPR4ES-11	4224	22 C	GR45	4268	22 J	GR45GP	3142	68 HS	BPR5EIX-11	2115	25 FO
	BP6ES-11	7334	27 C	BPR5ES-11	7634	22 C	BPR5EY-11	6937	22 J	BPR5EP-11 PGR5A-11 PGR5C-11	3971 3573 5760	111 GO 14 GL 93 BT	BPR6EIX-11	3903	25 FO
				BPR6ES-11 BPR7ES-11	7133 7226	22 C 22 C	BPR6EY-11	6261	22 J						
3/4" Reach 13/16" Hex Low Angle Gasket, Solid				BR8ECS BR9ECS BR10ECS SOLID	4172 4677 5940	217 FY 217 FY 217 FY							BR8ECSIX BR9ECSIX	5886 5438	225 GF 191 EY
3/4" Reach 13/16" Hex Low Angle, Narrow Gap Gasket, Solid				BR9ECS-5	6669	252 FY							BR9ECSIX-5	6014	225 GF
3/4" Reach 13/16" Hex Extended Projection Gasket, Solid							ZGR5A-4	90178	213 FV	ZGR5AGP	7102	279 HV			
3/4" Reach 13/16" Hex Extended Projection Gasket, Loose							ZGR5A	5077	213 FV						
3/4" Reach 13/16" Hex Extended Projection Extended Shell Gasket, Solid							ZGR5C	6334	237 GN						
3/4" Reach 13/16" Hex Projected 2-Ground Electrode Gasket, Loose				BPR5EKU	5685	202 FM									
3/4" Reach 13/16" Hex Projected 2-Ground Electrode Gasket, Solid				BPR6EKN	6757	304 D									

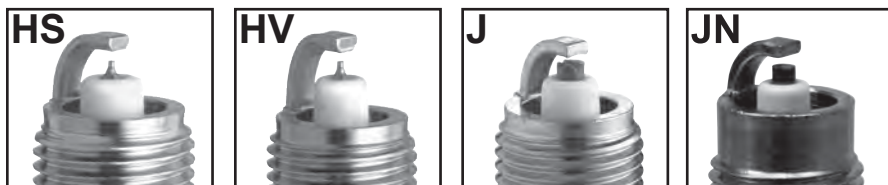
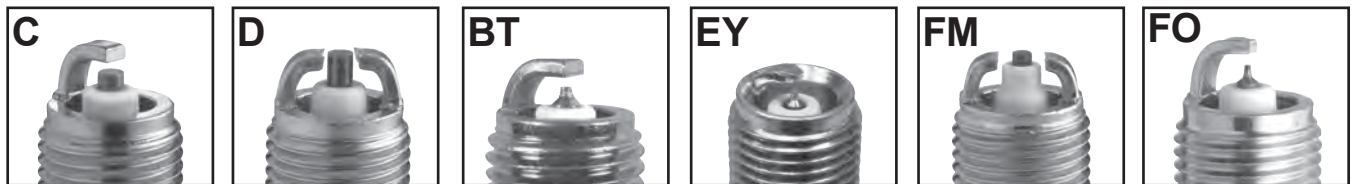
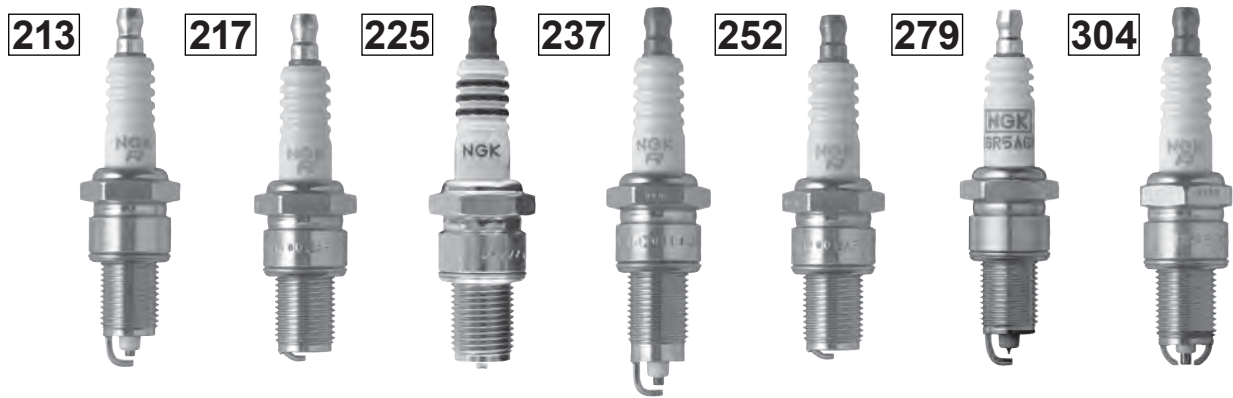
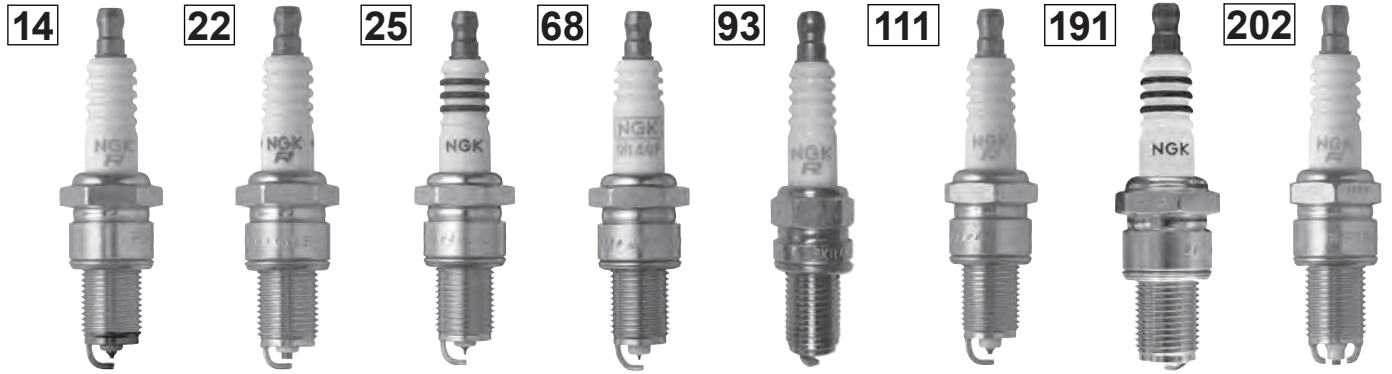





# NGK Spark Plug Specification Chart

THE IGNITION SPECIALIST™

Spark Plug charts are sorted by thread size, thread reach, hex size. Hotter plugs are listed above the colder plugs. Plug images are located on the opposite page.

	STD. NON-RESISTOR			STD. RESISTOR			V-POWER			PLATINUM			IRIDIUM		
	Part No.	Stk No.	Image	Part No.	Stk No.	Image	Part No.	Stk No.	Image	Part No.	Stk No.	Image	Part No.	Stk No.	Image
<b>14mm Spark Plugs cont'd</b>															
3/4" Reach 13/16" Hex 3-Ground Electrode Gasket, Solid				BR7ET BR8ET BR9ET	5877 6612 4528	121 CJ 121 CJ 121 CJ									
3/4" Reach 13/16" Hex 3-Ground Electrode Projected Gasket, Loose	BP6ET	1263	10 DD	BUR6ET	7517	80 BH									
21.5 mm Reach 13/16" Hex 4-Ground Electrode Gasket, Solid				BUR7EQ BUR9EQ	6917 5777	14 M 14 M				BUR7EQP BUR9EQP	4764 5255	14 M 14 M			
3/4" Reach 13/16" Hex 4-Ground Electrode Wide Gap Gasket, Solid				BR8EQ-14 BR9EQ-14	2329 3129	40 AT 40 AT									
3/4" Reach 13/16" Hex Semi-Surface Discharge Wide Gap Gasket, Solid				BUR4EB-11 BUR5EB-11 BUR6EB-11 BUR7EB-11	5370 6735 7037 6832	190 EW 190 EW 190 EW 190 EW	BUR6EA-11 BUR7EA-11	5428 7031	190 EX 190 EX						
3/4" Reach 13/16" Hex Surface Discharge Gasket, Solid	BUE	2322	39 AC												
19mm Reach 13/16" Hex Gasket, Solid Slant/Slit													RE9B-T	6701	85 BM
21mm Reach 13/16" Hex Gasket, Solid Slant/Slit													RE7C-L	6700	85 BM
25mm Reach 5/8" Hex Projected Tapered, Loose													ILTR6H8G	96870	358 KN
25mm Reach 5/8" Hex Projected Tapered, Solid										LTR6GP-8	94372	174 EH	ILTR5D ILTR5M9G ILTR6F9 ILTR6G8G ILTR6A-8G LTR6IX ILTR6M9G LTR6BI-9 LTR6CI-8 LTR6DI-8 SILTR6A7G ILTR7N8 ILTR7E9	5476 90882 90656 96621 3787 94374 94489 92182 97177 96588 95369 95822 90543	83 BK 100 CA 100 CA 100 CA 100 CA 246 GW 100 CA 100 CA 100 CA 100 CA 368 KX 100 CA 100 CA
25mm Reach 5/8" Hex Projected, Wide Gap Tapered, Solid										LTR5GP PTR5A-13  LTR6GP PLTR6A-10G LTR6BP13 LTR6DP13 LTR7CP13	5019 2467  90198 3587 94806 90374 94862	174 EH 46 AI  174 EH 89 BQ 170 LD 46 AI 46 AI	ILTR5B11 ILTR5C11 ILTR5K13 ILTR5L11 LTR5BI-13  LTR5IX-11 ILTR5E11 LTR6AI13 LTR6BI-13 ILTR6B11 ILTR6E11 LTR6IX-11	3474 5581 90607 96329 90083  4344 91418 95853 91725 5367 90117 6509 6510	83 BK 83 BK 83 BK 83 BK 104 CE  246 GW 83 BK 104 CE 104 CE 83 BK 83 BK 246 GW 246 GW

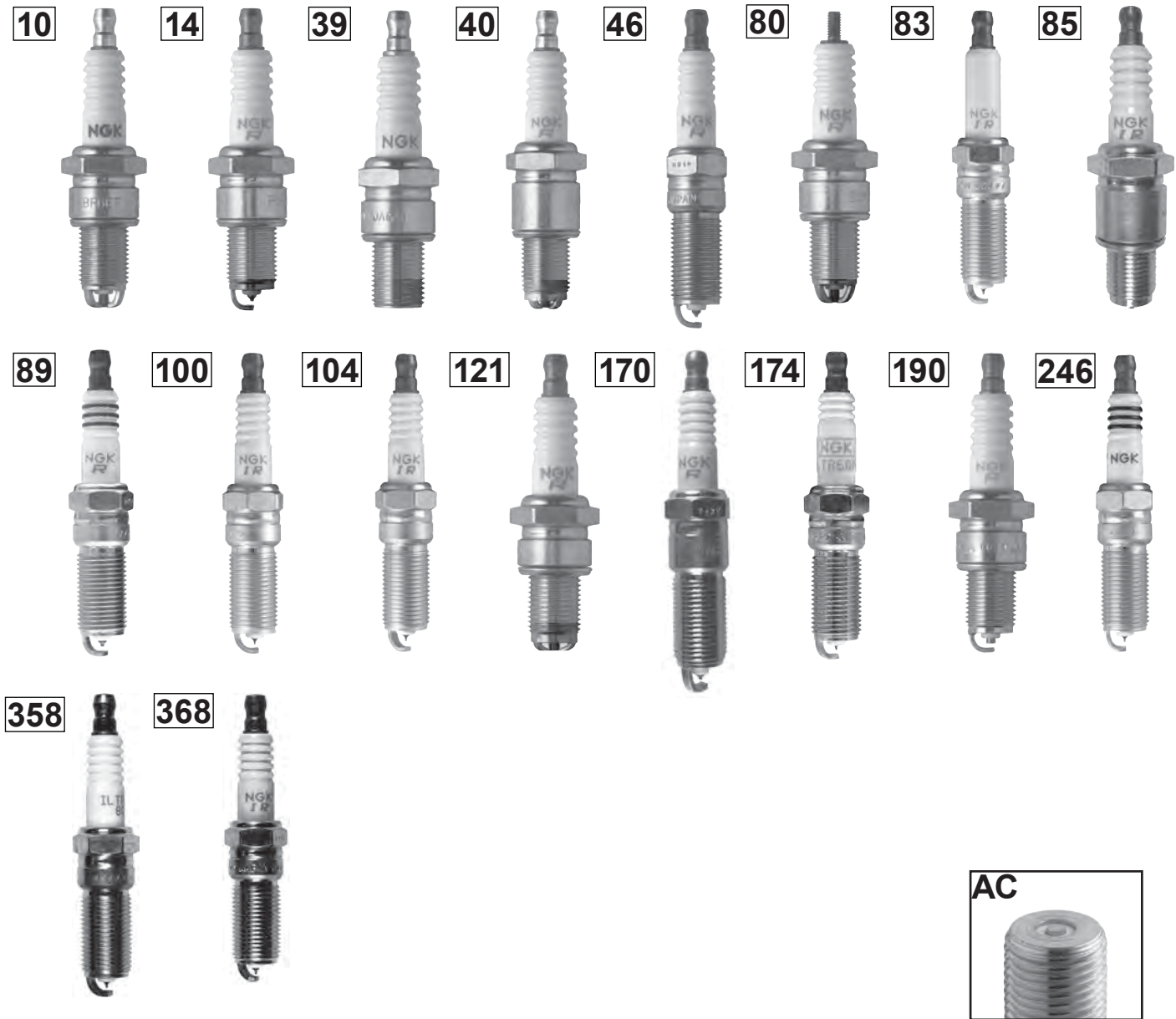



# NGK Spark Plug Specification Chart

THE IGNITION SPECIALIST™

Spark Plug charts are sorted by thread size, thread reach, hex size. Hotter plugs are listed above the colder plugs. Plug images are located on the opposite page.

	STD. NON-RESISTOR			STD. RESISTOR			V-POWER			PLATINUM			IRIDIUM		
	Part No.	Stk No.	Image	Part No.	Stk No.	Image	Part No.	Stk No.	Image	Part No.	Stk No.	Image	Part No.	Stk No.	Image
<b>14mm Spark Plugs cont'd</b>															
25mm Reach 5/8" Hex Extended Projection Wide Gap Tapered, Solid							LZTR4A-11	5306	188 EU	LZTR4AGP PLZTR4A-13	5017 4997	172 EF 170 ED	LZTR4AIX-11	2313	37 AA
							LZTR5A-13	4306	188 EU	LZTR5AGP PLZTR5A-13 LZTR6AP11EG	3381 4998 97408	172 EF 170 ED 170 ED	LZTR5AIX-13 LZTR6AIX-13 LZTR7AIX-13	2314 2315 5107	37 AA 37 AA 37 AA
25mm Reach 5/8" Hex Extend Shell Extended Projection Tapered, Solid													ILZTR6A8G	94769	383 LO
26.5mm Reach 5/8" Hex Projected Gasket, Solid							LFR4A-E LFR6A	6499 6668	244 GU 239 GP				ILFR6A ILFR6B LFR6AIX ILFR6G-E SILFR6A ILFR7H LFR7AIX	3588 6481 93893 4212 7913 5245 2309	196 FG 196 FG 136 CZ 196 FG 316 IU 196 FG 136 CZ
26.5mm Reach 5/8" Hex Projected, PSPE Gasket, Solid													SILFR6B8	373	366 KV
26.5mm Reach 5/8" Hex Projected, Wide Gap Gasket, Solid, PSPE										PLFR5A-11	6240	234 GL	SILFR5A11 SILFR6C11	92373 7505	367 KW 367 KW
26.5mm Reach 5/8" Hex Projected, Wide Gap Gasket, Solid							LFR5A-11 LFR6C-11 LFR6A-11	6376 7787 3672	239 GP 208 FR 239 GP	PLFR6C-10G LFR6CGP PLFR6A-11	1959 1483 7654	89 BQ 173 EG 234 GL	LFR5AIX-11 ILFR5B11 ILFR5T11 LFR6AIX-11 ILFR6J-11K ILFR6T11 SILFR6A11	4469 1637 96779 6619 4458 4904 5468	136 CZ 196 FG 165 DY 136 CZ 134 CX 165 DY 316 IU
26.5mm Reach 5/8" Hex Extended Projection Gasket, Solid													LZFR6AI	3656	95 BV
26.5mm Reach 5/8" Hex Wide Gap Extended Projection Gasket, Solid				LZFR5C-11	92174	363 KS				LZFR5AGP-E PLZFR5B13EG PLZFR6A-11S LZFR6AP116S	90192 97606 5987 95712	387 LS 223 GD 223 GD 223 GD	LZFR5BI-11 LZFR5CI-11 LZFR5AIX-11E ILZFR6D11	93298 92145 92460 1208	6 F 6 F 388 LT 6 F

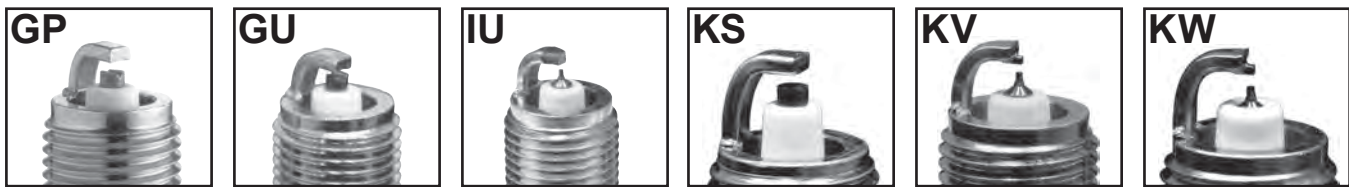
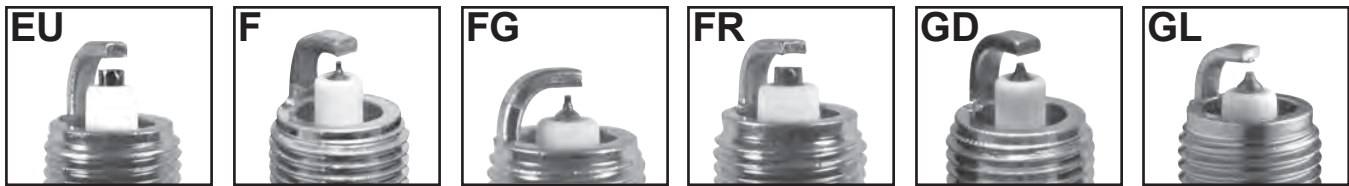
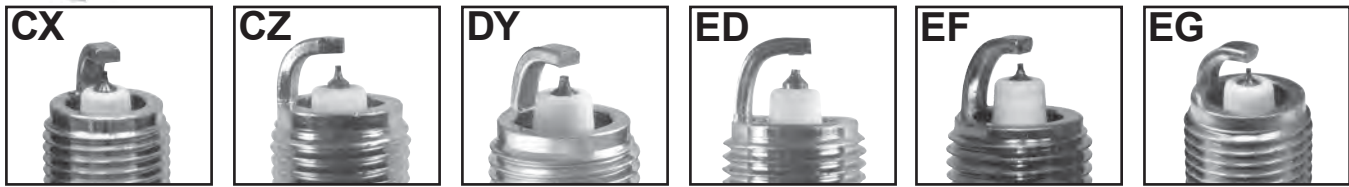
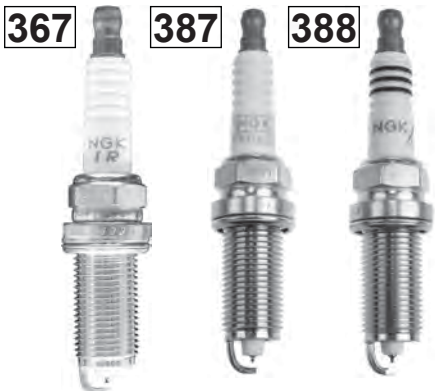
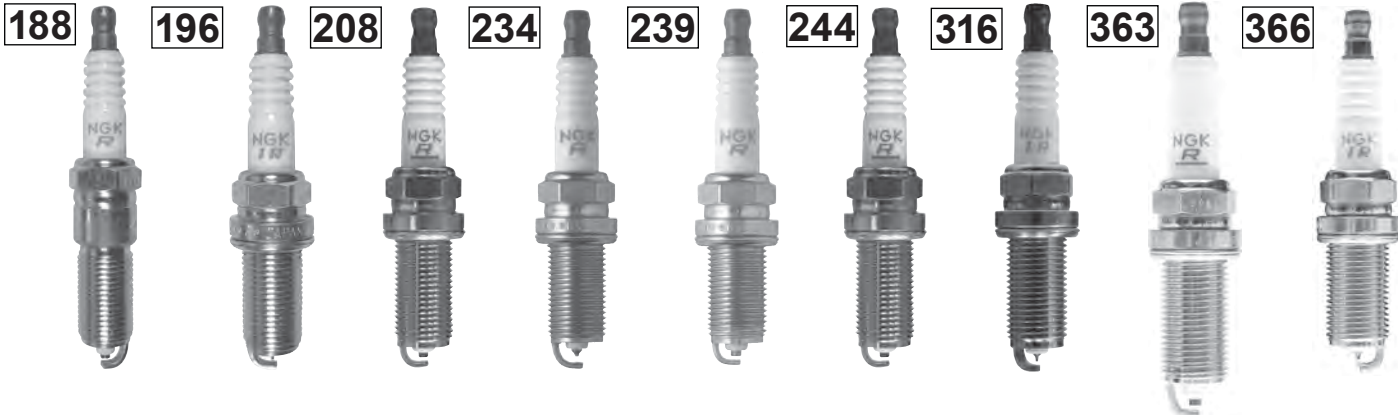

LS



# NGK Spark Plug Specification Chart

THE IGNITION SPECIALIST™

Spark Plug charts are sorted by thread size, thread reach, hex size. Hotter plugs are listed above the colder plugs. Plug images are located on the opposite page.

	STD. NON-RESISTOR			STD. RESISTOR			V-POWER			PLATINUM			IRIDIUM		
	Part No.	Stk No.	Image	Part No.	Stk No.	Image	Part No.	Stk No.	Image	Part No.	Stk No.	Image	Part No.	Stk No.	Image
<b>14mm Spark Plugs cont'd</b>															
26.5mm Reach 5/8" Hex Projected, Wide Gap Dual Fine Electrode Gasket, Solid													DILFR5A11	93759	192 EZ
													DILFR5A11D	98376	231 GI
													DILFR5C11D	6159	231 GI
													DILFR6D11	6176	232 GJ
													DILFR6J11	92491	341 KE
													DFH6B-11A	6858	323 JC
													DILFR7K9G	91961	192 EZ
													DILFR7B10G	97218	345 KF
26.5mm Reach 5/8" Hex 3-Ground Electrode Gasket, Solid				LFR6D	6490	149 DK									

<b>18mm Spark Plugs</b>															
12mm Reach	AB-2	3020	8 H												
13/16" Hex	AB-6	2910	8 H												
Gasket, Loose	AB-7	3010	8 H												
	AB-8	7909	8 H												
.460" Reach 13/16" Hex Tapered, Solid	A6FS	2210	32 X	AR6FS	3323	76 X									
.460" Reach 13/16" Hex Projected	AP7FS	2127	26 U				WR5	2438	45 AH				WR5IX	7510	295 IG
Tapered, Solid	AP8FS	2227	26 U												
.460" Reach 13/16" Hex Extended Projection Tapered, Solid							WR4-1	4652	143 DH						



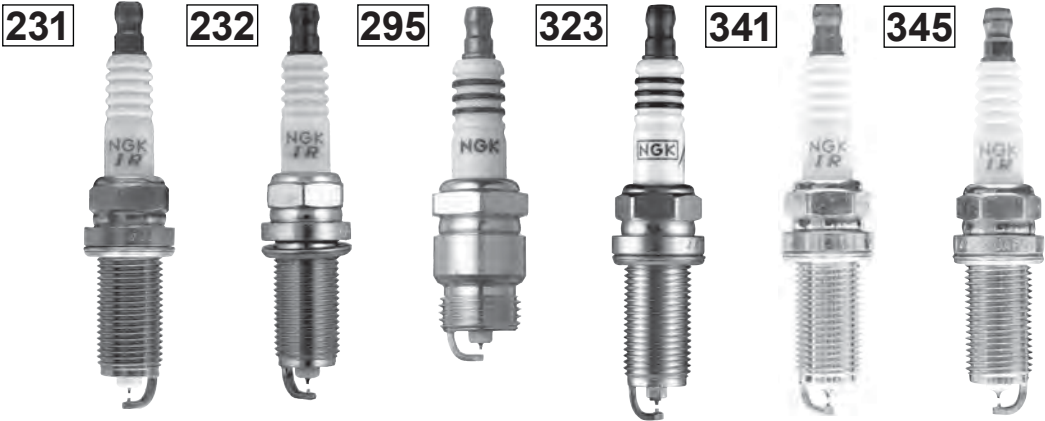



# NGK Spark Plug Specification Chart

THE IGNITION SPECIALIST™

Spark Plug charts are sorted by thread size, thread reach, hex size. Hotter plugs are listed above the colder plugs. Plug images are located on the opposite page.

RUTHENIUM HX			
	Part No.	Stk No.	Image
<b>12mm Spark Plugs</b>			
26.5mm Reach 14mm Hex Projected, Wide Gap Dual Fine Electrode Gasket, Solid	LKAR6AHX LKAR7AHX-S	97292 92274	396MA 396MA
26.5mm Reach 14mm Hex Projected PSPE Gasket, Solid	LKAR8BHX	91784	397MB
26.5mm Reach 5/8" Hex Projected, Wide Gap Dual Fine Electrode Gasket, Solid	LKR6AHX LKR7AHX-S	91356 96358	396MA 396MA
26.5mm Reach 5/8" Hex Projected PSPE Gasket, Solid	LKR6BHX-E LKR7BHX LKR8BHX-S	93763 94705 90465	397MB 397MB 397MB
<b>14mm Spark Plugs</b>			
.708" Reach 5/8" Hex Projected Wide Gap Dual Fine Electrode Tapered, Solid	TR5AHX TR6AHX	94567 92714	398MA 398MA
.708" Reach 5/8" Hex Projected PSPE Tapered, Solid	TR4BHX	97100	399MB
3/4" Reach 5/8" Hex ISO Projected Dual Fine Electrode Gasket, Solid	FR5AHX-E	92375	400MA
3/4" Reach 5/8" Hex ISO Projected Wide Gap Dual Fine Electrode Gasket, Solid	FR5AHX FR6AHX-S	95839 94279	400MA 400MA
3/4" Reach 5/8" Hex ISO Projected PSPE Gasket, Solid	FR6BHX-S FR7BHX-S	95159 92400	401MB 401MB

RUTHENIUM HX			
	Part No.	Stk No.	Image
<b>14mm Spark Plugs cont'd.</b>			
3/4" Reach 5/8" Hex ISO Projected Wide Gap PSPE Gasket, Solid	FR5BHX	96457	401MB
25mm Reach 5/8" Hex Projected Dual Fine Electrode Tapered, Solid	LTR5AHX	90220	402MA
25mm Reach 5/8" Hex Projected, Wide Gap Dual Fine Electrode Tapered, Solid	LTR6AHX	91276	402MA
25mm Reach 5/8" Hex Projected PSPE Tapered, Solid	LTR6BHX LTR7BHX	90495 95605	403MB 403MB
2.6mm Reach 5/8" Hex Projected Dual Fine Electrode Gasket, Solid	LFR5AHX	96355	404MA
26.5mm Reach 5/8" Hex Projected, Wide Gap Dual Fine Electrode Gasket, Solid	LFR6AHX-S	94122	404MA
26.5mm Reach 5/8" Hex Projected PSPE Gasket, Solid	LFR6BHX LFR7BHX	93420 95125	405MB 406MB





# NGK Spark Plug Specification Chart

THE IGNITION SPECIALIST™

Spark plug charts are sorted by thread size, thread reach, hex size. Hotter plugs are listed above the colder plugs. Plug images are located on the opposite page.

	NGK Racing			NGK Standard		
	Part No.	Stock No.	Image	Part No.	Stock No.	Image
<b>Racing Spark Plugs</b>						
<b>10mm Spark Plugs</b>						
3/4" Reach 5/8" Hex Surface Discharge Gasket, Solid Non-Resistor	R0045J-9	5861	286 AC			
3/4" Reach 5/8" Hex Surface Discharge Gasket, Loose Resistor	R0045Q-9 R0045Q-10 R0045Q-11	3235 4216 5957	286 AC 286 AC 286 AC			
3/4" Reach 5/8" Hex Fine Wire, Iridium Gasket, Stud Resistor	R0373A-9 R0373A-10 R0373A-11	3388 4940 5566	168 EB 168 EB 168 EB			
3/4" Reach 5/8" Hex Fine Wire, Iridium Gasket, Solid Resistor	R0406A-8	1480	168 EB			
3/4" Reach 5/8" Hex Fine Wire Gasket, Stud Resistor, Partial Thread	R0409B-8	7791	253 IC			
26.5mm Reach 14mm Hex Fine Wire, Iridium Gasket, Solid Resistor	R0451B-8	9356	338 JR			
<b>12mm Spark Plugs</b>						
3/4" Reach 5/8" Hex Surface Discharge Gasket, Solid Resistor	R2349-10	6839	128 AC			
3/4" Reach 5/8" Hex Platinum Gasket, Loose Resistor	R2525-9 R2525-10	4735 5281	128 IC 128 IC			
26.5mm Reach 5/8" Hex Iridium Gasket, Solid Resistor	R2556B-8 R2556G-8 R2556G-9 R2558E-9 R2556B-10 R2556G-10	6453 91975 93253 97537 1997 91185	329 IC 329 IC 329 IC 329 IC 329 IC 329 IC			
<b>14mm Spark Plugs</b>						
3/8" Reach 13/16" Hex Projected V-Power Gasket, Solid Non-Resistor	R5670-5 R5670-6 R5670-7 R5670-8 R5670-9	2298 2746 2891 3354 3913	35 DC 35 DC 35 DC 35 DC 35 DC	XR5	3332	214 DC

	NGK Racing			NGK Standard		
	Part No.	Stock No.	Image	Part No.	Stock No.	Image
<b>Racing Spark Plugs</b>						
<b>14mm Spark Plugs cont'd</b>						
.460" Reach 5/8" Hex V-Power Tapered, Solid Non-Resistor	R5673-6 R5673-7 R5673-8 R5673-9 R5673-10	2405 2817 3249 3442 4050	118 HQ 118 HQ 118 HQ 118 HQ 118 HQ	BR6FS	4323	129 CS
.460" Reach 5/8" Hex V-Power Projected Tapered, Solid Non-Resistor	R5674-6 R5674-7 R5674-8 R5674-9 R5674-10	4449 5034 5657 6468 6702	255 HB 255 HB 255 HB 255 HB 255 HB	UR6	7773	47 HB
.708" Reach 5/8" Hex Projected Tapered, Solid Non-Resistor	R5724-8 R5724-9 R5724-10	7317 7891 7993	320 IZ 320 IZ 320 IZ			
3/4" Reach 5/8" Hex V-Power Gasket, Solid Non-Resistor	R5671A-7 R5671A-8 R5671A-9 R5671A-10 R5671A-11	4091 4554 5238 5820 6596	212 IV 212 IV 212 IV 212 IV 212 IV			
3/4" Reach 5/8" Hex V-Power, Projected Gasket, Solid Non-Resistor	R5672A-8 R5672A-9 R5672A-10	7173 7405 7942	3 L 3 L 3 L	BKR8EIX BKR9EIX	2668 2669	204 FO 204 FO
3/4" Reach 5/8" Hex Iridium, Short Gasket, Solid Resistor	R7282-10 R7282-105 R7282-11	2000 4985 2001	21 IC 21 IC 21 IC			
3/4" Reach 5/8" Hex Semi-Surface Discharge Gasket, Solid Non-Resistor	R6711-9 R6711-10	3167 2919	212 AC 212 AC			
3/4" Reach 5/8" Hex Semi-Surface Discharge Gasket, Solid Resistor	R6601-10 R6601-11	4017 4586	212 AC 212 AC			
3/4" Reach 5/8" Hex Iridium ISO, Low Angle Ground Electrode Gasket, Solid Resistor	R7434-10	4894	162 DV			
3/4" Reach 5/8" Hex Iridium ISO, Projected Gasket, Solid Resistor	R7433-8 R7433-9	4889 4660	161 DU 161 DU			







# NGK Spark Plug Specification Chart

THE IGNITION SPECIALIST™

Spark plug charts are sorted by thread size, thread reach, hex size. Hotter plugs are listed above the colder plugs. Plug images are located on the opposite page.

	NGK Racing			NGK Standard		
	Part No.	Stock No.	Image	Part No.	Stock No.	Image
<b>Racing Spark Plugs</b>						
<b>14mm Spark Plugs cont'd</b>						
3/4" Reach 5/8" Hex Iridium, JIS, Projected Gasket, Solid Resistor	R7435-9	4896	163 DW			
	R7435-10	4897	163 DW			
3/4" Reach 5/8" Hex Iridium JIS, Low Angle Ground Electrode Gasket, Solid Resistor	R7436-9	4899	164 DX			
	R7436-10	4900	164 DX			
3/4" Reach 13/16" Hex Low Angle Ground Electrode Gasket, Solid Non-Resistor	R6061-9	4074	222 GC			
	R6254E-9	5583	108 IC			
	R6061-10	5962	222 GC			
	R6254E-105	3949	108 IC			
	R6254K-105	4076	108 IC			
	R6061-11	2773	222 GC			
3/4" Reach 13/16" Hex Low Angle Ground Electrode Gasket, Solid Resistor	R6252E-105	2396	108 IC			
	R6252K-105	2741	108 IC			
3/4" Reach 13/16" Hex Gold Palladium Gasket, Loose Non-Resistor	R4118S-8	3236	235 BD			
3/4" Reach 13/16" Hex Platinum Low Angle Ground Electrode Gasket, Solid Resistor	R6918B-7	6259	108 IC			
	R6918B-8	4492	108 IC			
	R6918B-9	2954	108 IC			
	R6918C-9	5196	108 IC			
3/4" Reach 13/16" Hex Iridium Low Angle Ground Electrode Gasket, Solid Resistor	R7376-8	5442	133 CW			
	R7376-9	7763	133 CW			
	R7376-10	4457	133 CW			
3/4" Reach 13/16" Hex Fine Wire Gasket, Loose Non-Resistor	B8EG	3430	92 BS	B8ES	2411	317 IV
	B9EG	3530	92 BS	B9ES	2611	317 IV
	B10EG	3630	92 BS	B10ES	7928	317 IV
	B11EG	2055	92 BS			
3/4" Reach 13/16" Hex Fine Wire Gasket, Loose Resistor	BR8EG	3130	105 BS	BR8ES	5422	158 IV
	BR9EG	3230	105 BS	BR9ES	5722	158 IV
	R6021E-9	2401	158 BD			
	BR10EG	3830	105 BS			

	NGK Racing			NGK Standard		
	Part No.	Stock No.	Image	Part No.	Stock No.	Image
<b>Racing Spark Plugs</b>						
<b>14mm Spark Plugs cont'd</b>						
3/4" Reach 13/16" Hex Fine Wire Gasket, Solid Non-Resistor	B8EG SOLID	3997	113 BS	B8ES	3683	315 IV
	B9EG SOLID	3998	113 BS	B9ES	7148	315 IV
3/4" Reach 13/16" Hex Fine Wire Gasket, Solid Resistor	BR8EG SOLID	3992	112 BS	BR8ES	3961	147 IV
	BR9EG SOLID	4015	112 BS	BR9ES	3194	147 IV
	BR9EG-N-8	2689	51 AN			
	BR10EG SOLID	3993	112 BS			
3/4" Reach 13/16" Hex Surface Discharge Gasket, Loose Resistor	R6712-9	5644	186 AC			
21mm Reach 13/16" Hex Iridium Low Angle Ground Electrode Gasket, Solid Resistor	R7420-9	6448	332 JL			
	R7440A-10L	4282	102 CC			
	R7420-10	5501				
	R7420-105	4857	332 JL			
	R7420-11	7756	332 JL			
21.5mm Reach 13/16" Hex Platinum Low Angle Ground Electrode Gasket, Solid Resistor	R6725-105	3857	79 BG			
	R6725-11	4311	79 BG			
	R6725-115	4482	79 BG			
22mm Reach 5/8" Hex Iridium Low Angle Ground Electrode Short Gasket, Solid Resistor	R7282A-10	3920	21 IC			
26.5mm Reach 5/8" Hex Iridium Projected Gasket, Solid Resistor	R7437-8	4901	144 DI			
	R7437-9	4654	144 DI			
26.5mm Reach 5/8" Hex Iridium Low Angle Ground Electrode Gasket, Solid Resistor	R7438-8	4905	145 DJ			
	R7438-9	4656	145 DJ			
<b>18mm Spark Plugs</b>						
16mm Reach 25.4mm Hex Gasket, Loose Non-Resistor	R8102A-10	6813	261 HH			

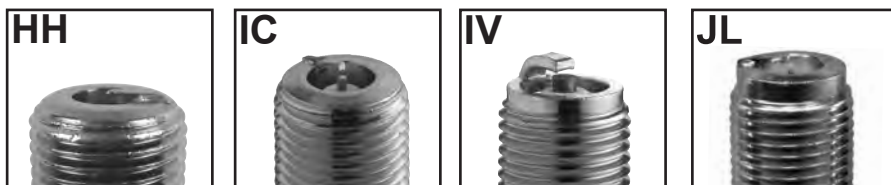
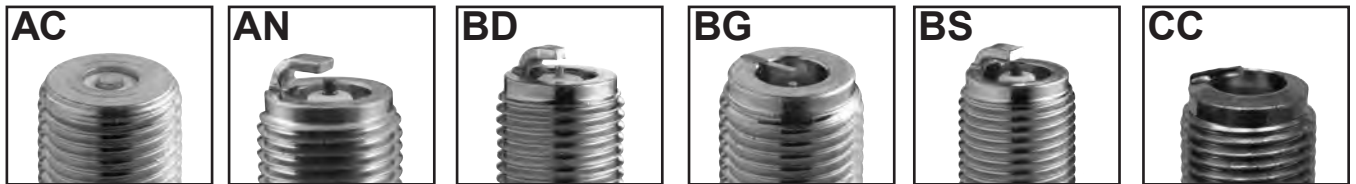





*THE IGNITION SPECIALIST™*

# APPLICATION GUIDE

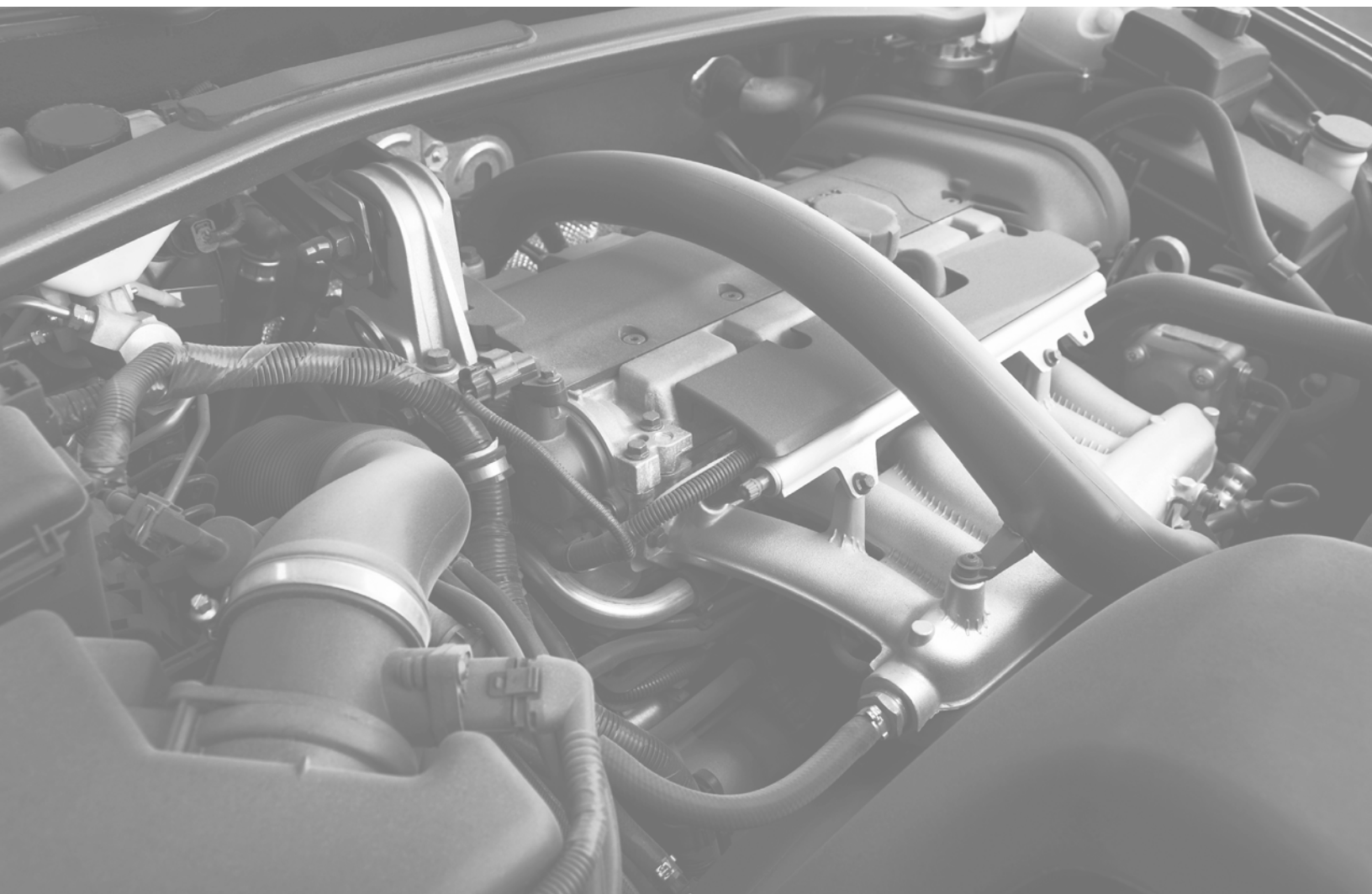



Year	Cyl. L	Notes	Original Equipment		Ruthenium HX		Iridium IX		G-Power		V-Power		Gap
			Part	Stock	Part	Stock	Part	Stock	Part	Stock	Part	Stock	
<b>ACURA</b>													
<b>CL</b>													
2003-01	V6 3.2L	Eng Desg J32A1	<b>PZFR5F-11</b>	<b>4363</b>	FR5AHX	95839	ZFR5FIX-11	2477	ZFR5FGP	7098	ZFR5F-11	2262	.044
		Type-S, Eng Desg J32A2	<b>PZFR6E-11</b>	<b>7790</b>	FR6AHX-S	94279	ZFR6FIX-11	6441	ZFR6FGP	7100	ZFR6F-11	4291	.044
1999-98	L4 2.3L		<b>PZFR5F-11</b>	<b>4363</b>	FR5AHX	95839	ZFR5FIX-11	2477	ZFR5FGP	7098	ZFR5F-11	2262	.044
	V6 3.0L		<b>PZFR5F-11</b>	<b>4363</b>	FR5AHX	95839	ZFR5FIX-11	2477	ZFR5FGP	7098	ZFR5F-11	2262	.044
1997	L4 2.2L		<b>ZFR5F-11</b>	<b>2262</b>	FR5AHX	95839	ZFR5FIX-11	2477	ZFR5FGP	7098	ZFR5F-11	2262	.044
	V6 3.0L		<b>PZFR5F-11</b>	<b>4363</b>	FR5AHX	95839	ZFR5FIX-11	2477	ZFR5FGP	7098	ZFR5F-11	2262	.044
<b>CSX</b>													
2011	L4 2.0L		<b>IZFR6K11</b>	<b>6994</b>	FR6AHX-S	94279	ZFR6AIX-11S	97138	ZFR6BGP-S	92213			.044
2010-07	L4 2.0L	Eng Desg K20Z2	<b>IZFR6K11</b>	<b>6994</b>	FR6AHX-S	94279	ZFR6AIX-11S	97138	ZFR6BGP-S	92213			.044
		Type-S, Eng Desg K20Z3	<b>IFR7G-11KS</b>	<b>7746</b>	FR7BHX-S	92400							.044
2006	L4 2.0L		<b>IZFR6K11</b>	<b>6994</b>	FR6AHX-S	94279	ZFR6AIX-11S	97138	ZFR6BGP-S	92213			.044
<b>EL</b>													
2005-04	L4 1.7L		<b>PZFR6F-11</b>	<b>3271</b>	FR6AHX-S	94279	ZFR6FIX-11	6441	ZFR6FGP	7100	ZFR6F-11	4291	.044
2003-01	L4 1.7L		<b>PZFR6F-11</b>	<b>3271</b>	FR6AHX-S	94279	ZFR6FIX-11	6441	ZFR6FGP	7100	ZFR6F-11G	6987	.044
2000-97	L4 1.6L		<b>ZFR5F-11</b>	<b>2262</b>	FR5AHX	95839	ZFR5FIX-11	2477	ZFR5FGP	7098	ZFR5F-11	2262	.044
<b>ILX</b>													
2018-16	L4 2.4L		<b>DILKAR7H11GS</b>	<b>96964</b>	LKAR7AHX-S	92274							.044
2015-13	L4 1.5L	Dual Plug; 8 Req'd	<b>DILFR6J11</b>	<b>92491</b>	LF6AHX-S	94122	LF6AIX-11	6619	LF6CGP	1483			.044
	L4 2.0L		<b>DILZKR7B11GS</b>	<b>95710</b>	LKR7AHX-S	96358	LKR7DIX-11S	93175	LKR7BGP-S	97390			.044
	L4 2.4L		<b>ILZKR7B-11S</b>	<b>5787</b>	LKR7AHX-S	96358	LKR7DIX-11S	93175	LKR7BGP-S	97390			.044
<b>Integra</b>													
2001	L4 1.8L	Eng Desg B18B1	<b>PZFR5F-11</b>	<b>4363</b>	FR5AHX	95839	ZFR5FIX-11	2477	ZFR5FGP	7098	ZFR5F-11	2262	.044
		Eng Desg B18C1	<b>PFR6G-13</b>	<b>4115</b>	FR6AHX-S	94279	BKR6EIX-11	3764	BKR6EGP	7092	BKR6E-11	2756	.052
		Eng Desg B18C5	<b>PFR7G-11</b>	<b>2380</b>			BKR7EIX-11	6988			BKR7E-11	5791	.044
2000	L4 1.8L	Eng Desg B18B1	<b>PZFR5F-11</b>	<b>4363</b>	FR5AHX	95839	ZFR5FIX-11	2477	ZFR5FGP	7098	ZFR5F-11	2262	.044
		Eng Desg B18C1	<b>PFR6G-13</b>	<b>4115</b>	FR6AHX-S	94279	BKR6EIX-11	3764	BKR6EGP	7092	BKR6E-11	2756	.052
		Eng Desg B18C5	<b>PFR6G-11</b>	<b>5555</b>	FR6AHX-S	94279	BKR6EIX-11	3764	BKR6EGP	7092	BKR6E-11	2756	.044
1999-97	L4 1.8L	Eng Desg B18B1	<b>ZFR5F-11</b>	<b>2262</b>	FR5AHX	95839	ZFR5FIX-11	2477	ZFR5FGP	7098	ZFR5F-11	2262	.044
		Eng Desg B18C1	<b>PFR6G-13</b>	<b>4115</b>	FR6AHX-S	94279	BKR6EIX-11	3764	BKR6EGP	7092	BKR6E-11	2756	.052
		Eng Desg B18C5	<b>PFR6G-11</b>	<b>5555</b>	FR6AHX-S	94279	BKR6EIX-11	3764	BKR6EGP	7092	BKR6E-11	2756	.044
1996-94	L4 1.8L	Eng Desg B18B1	<b>ZFR5F-11</b>	<b>2262</b>			ZFR5FIX-11	2477	ZFR5FGP	7098	ZFR5F-11	2262	.044
		Eng Desg B18C1	<b>PFR6G-13</b>	<b>4115</b>			BKR6EIX-11	3764	BKR6EGP	7092	BKR6E-11	2756	.052
1993-92	L4 1.7L		<b>PFR6G-13</b>	<b>4115</b>			BKR6EIX-11	3764	BKR6EGP	7092	BKR6E-11	2756	.052
	L4 1.8L		<b>ZFR5F-11</b>	<b>2262</b>			ZFR5FIX-11	2477	ZFR5FGP	7098	ZFR5F-11	2262	.044
1991-90	L4 1.8L		<b>BCPR5E-11</b>	<b>1273</b>			BCPR5EIX-11	3306	BCPR5EGP	7086	BCPR5E-11	1273	.044
1989-88	L4 1.6L		<b>BCPR6E-11</b>	<b>5632</b>			BCPR6EIX-11	4919	BCPR6EGP	7088	BCPR6E-11	5632	.044
1987-86	L4 1.6L		<b>BCPR6EY-N-11</b>	<b>6262</b>			BCPR6EIX-11	4919	BCPR6EGP	7088	BCPR6EY-N-11	6262	.044
<b>Legend</b>													
1995-91	V6 3.2L		<b>PFR6G-11</b>	<b>5555</b>			BKR6EIX-11	3764	BKR6EGP	7092	BKR6E-11	2756	.044
1990-88	V6 2.7L		<b>BCPR6E-11</b>	<b>5632</b>			BCPR6EIX-11	4919	BCPR6EGP	7088	BCPR6E-11	5632	.044
1987	V6 2.5L		<b>BCPR6E-11</b>	<b>5632</b>			BCPR6EIX-11	4919	BCPR6EGP	7088	BCPR6E-11	5632	.044
	V6 2.7L		<b>BCPR6E-11</b>	<b>5632</b>			BCPR6EIX-11	4919	BCPR6EGP	7088	BCPR6E-11	5632	.044
1986	V6 2.5L		<b>BCPR6E-11</b>	<b>5632</b>			BCPR6EIX-11	4919	BCPR6EGP	7088	BCPR6E-11	5632	.044
<b>MDX</b>													
2018-17	V6 3.0L		<b>ILZKR7B11</b>	<b>7751</b>	LKR7AHX-S	96358	LKR7DIX-11S	93175	LKR7BGP-S	97390			.044
	V6 3.5L		<b>DILZKR7B11G</b>	<b>95350</b>	LKR7AHX-S	96358	LKR7DIX-11S	93175	LKR7BGP-S	97390			.044
2016-14	V6 3.5L		<b>DILZKR7B11G</b>	<b>95350</b>	LKR7AHX-S	96358	LKR7DIX-11S	93175	LKR7BGP-S	97390			.044
2013-10	V6 3.7L		<b>ILZKR7B-11S</b>	<b>5787</b>	LKR7AHX-S	96358	LKR7DIX-11S	93175	LKR7BGP-S	97390			.044
2009-07	V6 3.7L		<b>IZFR6K11</b>	<b>6994</b>	FR6AHX-S	94279	ZFR6AIX-11S	97138	ZFR6BGP-S	92213			.044
2006-03	V6 3.5L		<b>IZFR5K11</b>	<b>3657</b>			ZFR5AIX-11	94553	ZFR5BGP	90804			.044
2002-01	V6 3.5L		<b>PZFR5F-11</b>	<b>4363</b>	FR5AHX	95839	ZFR5FIX-11	2477	ZFR5FGP	7098	ZFR5F-11	2262	.044
<b>NSX</b>													
2005-97	V6 3.0L		<b>PFR6L-11</b>	<b>4639</b>	FR6AHX-S	94279	BKR6EIX-11	3764	BKR6EGP	7092	BKR6E-11	2756	.044
	V6 3.2L		<b>PFR6L-11</b>	<b>4639</b>	FR6AHX-S	94279	BKR6EIX-11	3764	BKR6EGP	7092	BKR6E-11	2756	.044
1996-95	V6 3.0L		<b>PFR6N-11</b>	<b>3546</b>			BKR6EIX-11	3764	BKR6EGP	7092	BKR6E-11	2756	.044
1994-91	V6 3.0L		<b>PFR6G-11</b>	<b>5555</b>			BKR6EIX-11	3764	BKR6EGP	7092	BKR6E-11	2756	.044





Year	Cyl. L	Notes	Original Equipment		Ruthenium HX		Iridium IX		G-Power		V-Power		Gap		
			Part	Stock	Part	Stock	Part	Stock	Part	Stock	Part	Stock			
<b>ACURA (Cont'd)</b>															
<b>RDX</b>															
2018-13	V6 3.5L		<b>ILZKR7B11</b>	<b>7751</b>	LKR7AHX-S	96358	LKR7DIX-11S	93175	LKR7BGP-S	97390			.044		
2012-07	L4 2.3L		<b>SILKR8A-S</b>	<b>1402</b>	LKR8BHX-S	90465							.032		
<b>RL</b>															
2012-09	V6 3.7L		<b>ILZKR7B-11S</b>	<b>5787</b>	LKR7AHX-S	96358	LKR7DIX-11S	93175	LKR7BGP-S	97390			.044		
2008-05	V6 3.5L		<b>IZFR6K11</b>	<b>6994</b>	FR6AHX-S	94279	ZFR6AIX-11S	97138	ZFR6BGP-S	92213			.044		
2004-03	V6 3.5L		<b>PFR5L-11</b>	<b>5459</b>	FR5AHX	95839	BKR5EIX-11	5464	BKR5EGP	7090	BKR5E-11	6953	.044		
2002-97	V6 3.5L		<b>PFR5L-11</b>	<b>5459</b>	FR5AHX	95839	BKR5EIX-11	5464	BKR5EGP	7090	BKR5E-N-11	2391	.044		
1996	V6 3.5L		<b>PFR5L-11</b>	<b>5459</b>			BKR5EIX-11	5464	BKR5EGP	7090	BKR5E-N-11	2391	.044		
<b>RLX</b>															
2019-14	V6 3.5L		<b>DILZKR7B11G</b>	<b>95350</b>	LKR7AHX-S	96358	LKR7DIX-11S	93175	LKR7BGP-S	97390			.044		
<b>RSX</b>															
2006-05	L4 2.0L	Eng Desg K20A3	<b>IZFR6K11</b>	<b>6994</b>	FR6AHX-S	94279	ZFR6AIX-11S	97138	ZFR6BGP-S	92213			.044		
		Type-S, Eng Desg K20Z1	<b>IFR7G-11KS</b>	<b>7746</b>	FR7BHX-S	92400							.044		
2004-03	L4 2.0L	Eng Desg K20A3	<b>IZFR6K11</b>	<b>6994</b>	FR6AHX-S	94279	ZFR6AIX-11S	97138	ZFR6BGP-S	92213			.044		
		Type-S, Eng Desg K20A2	<b>IFR7G-11KS</b>	<b>7746</b>	FR7BHX-S	92400							.044		
2002	L4 2.0L	Eng Desg K20A2	<b>IFR7G-11KS</b>	<b>7746</b>	FR7BHX-S	92400							.044		
		Eng Desg K20A3	<b>IZFR6K11</b>	<b>6994</b>	FR6AHX-S	94279	ZFR6AIX-11S	97138	ZFR6BGP-S	92213			.044		
<b>SLX</b>															
1999-98	V6 3.5L				BKR5E-N-11	2391	FR5AHX	95839	BKR5EIX-11	5464	BKR5EGP	7090	BKR5E-N-11	2391	.042
1997	V6 3.2L		<b>PFR5G-11</b>	<b>2647</b>	FR5AHX	95839	BKR5EIX-11	5464	BKR5EGP	7090	BKR5E-N-11	2391	.042		
1996	V6 3.2L		<b>PFR5G-11</b>	<b>2647</b>			BKR5EIX-11	5464	BKR5EGP	7090	BKR5E-N-11	2391	.042		
<b>TL</b>															
2014-13	V6 3.5L		<b>DILZKR7A11G</b>	<b>92924</b>	LKR7AHX-S	96358	LKR7DIX-11S	93175	LKR7BGP-S	97390			.044		
	V6 3.7L		<b>ILZKR7B-11S</b>	<b>5787</b>	LKR7AHX-S	96358	LKR7DIX-11S	93175	LKR7BGP-S	97390			.044		
2012-09	V6 3.5L		<b>ILZKR7B11</b>	<b>7751</b>	LKR7AHX-S	96358	LKR7DIX-11S	93175	LKR7BGP-S	97390			.044		
	V6 3.7L		<b>ILZKR7B-11S</b>	<b>5787</b>	LKR7AHX-S	96358	LKR7DIX-11S	93175	LKR7BGP-S	97390			.044		
2008-07	V6 3.2L		<b>IZFR6K11</b>	<b>6994</b>	FR6AHX-S	94279	ZFR6AIX-11S	97138	ZFR6BGP-S	92213			.044		
	V6 3.5L		<b>IZFR6K11</b>	<b>6994</b>	FR6AHX-S	94279	ZFR6AIX-11S	97138	ZFR6BGP-S	92213			.044		
2006-04	V6 3.2L		<b>IZFR6K11</b>	<b>6994</b>	FR6AHX-S	94279	ZFR6AIX-11S	97138	ZFR6BGP-S	92213			.044		
2003-02	V6 3.2L	Eng Desg J32A1	<b>PZFR5F-11</b>	<b>4363</b>	FR5AHX	95839	ZFR5FIX-11	2477	ZFR5FGP	7098	ZFR5F-11	2262	.044		
		Type-S, Eng Desg J32A2	<b>PZFR6E-11</b>	<b>7790</b>	FR6AHX-S	94279	ZFR6FIX-11	6441	ZFR6FGP	7100	ZFR6F-11	4291	.044		
2001-99	V6 3.2L		<b>PZFR5F-11</b>	<b>4363</b>	FR5AHX	95839	ZFR5FIX-11	2477	ZFR5FGP	7098	ZFR5F-11	2262	.044		
1998-97	L5 2.5L		<b>BKR5E-N-11</b>	<b>2391</b>	FR5AHX	95839	BKR5EIX-11	5464	BKR5EGP	7090	BKR5E-N-11	2391	.044		
	V6 3.2L		<b>PFR5L-11</b>	<b>5459</b>	FR5AHX	95839	BKR5EIX-11	5464	BKR5EGP	7090	BKR5E-N-11	2391	.044		
1996	L5 2.5L		<b>BKR5E-N-11</b>	<b>2391</b>			BKR5EIX-11	5464	BKR5EGP	7090	BKR5E-N-11	2391	.044		
	V6 3.2L		<b>PFR5L-11</b>	<b>5459</b>			BKR5EIX-11	5464	BKR5EGP	7090	BKR5E-N-11	2391	.044		
1995	L5 2.5L		<b>BKR5E-N-11</b>	<b>2391</b>			BKR5EIX-11	5464	BKR5EGP	7090	BKR5E-N-11	2391	.044		
<b>TLX</b>															
2019-15	L4 2.4L		<b>DILKAR7H11GS</b>	<b>96964</b>	LKAR7AHX-S	92274							.044		
	V6 3.5L		<b>DILZKR7B11G</b>	<b>95350</b>	LKR7AHX-S	96358	LKR7DIX-11S	93175	LKR7BGP-S	97390			.044		
<b>TSX</b>															
2014-10	L4 2.4L		<b>ILZKR7B-11S</b>	<b>5787</b>	LKR7AHX-S	96358	LKR7DIX-11S	93175	LKR7BGP-S	97390			.044		
	V6 3.5L		<b>ILZKR7B11</b>	<b>7751</b>	LKR7AHX-S	96358	LKR7DIX-11S	93175	LKR7BGP-S	97390			.044		
2009	L4 2.4L		<b>ILZKR7B-11S</b>	<b>5787</b>	LKR7AHX-S	96358	LKR7DIX-11S	93175	LKR7BGP-S	97390			.044		
2008-04	L4 2.4L		<b>IZFR6K11</b>	<b>6994</b>	FR6AHX-S	94279	ZFR6AIX-11S	97138	ZFR6BGP-S	92213			.044		
<b>Vigor</b>															
1994-92	L5 2.5L		<b>BKR5E-N-11</b>	<b>2391</b>			BKR5EIX-11	5464	BKR5EGP	7090	BKR5E-N-11	2391	.044		
<b>ZDX</b>															
2013-10	V6 3.7L		<b>ILZKR7B-11S</b>	<b>5787</b>	LKR7AHX-S	96358	LKR7DIX-11S	93175	LKR7BGP-S	97390			.044		
<b>ALFA ROMEO</b>															
<b>164</b>															
1995-94	V6 3.0L		<b>PFR6B</b>	<b>3500</b>			BKR6EIX	6418	BKR6EGP	7092	BKR6E	6962	.025		
1993-92	V6 3.0L	L	PGR7A	3200			BPR7EIX	4055					.025		
		Sport	<b>PFR6B</b>	<b>3500</b>			BKR6EIX	6418	BKR6EGP	7092	BKR6E	6962	.025		
1991	V6 3.0L	Base	PGR7A	3200			BPR7EIX	4055					.025		

**Bold denotes NGK OE Manufacturer and/or OE Service Part**  
NOT BOLD denotes OE Equivalent Part

**Le texte en gras désigne une pièce d'équipement originale du manufacturier NGK et/ou pièce d'équipement originale de service**  
Le texte non en gras désigne une pièce d'équipement originale équivalente

Note: Due to different operating or engine conditions, alternate heat range plugs may be required.

Note: En raison de différences au niveau du fonctionnement ou des conditions du moteur, d'autres types de bougies avec variation de chaleur peuvent être nécessaires



Year	Cyl. L	Notes	Original Equipment		Ruthenium HX		Iridium IX		G-Power		V-Power		Gap
			Part	Stock	Part	Stock	Part	Stock	Part	Stock	Part	Stock	
<b>ALFA ROMEO (Cont'd)</b>													
<b>164 (Cont'd)</b>													
1991		L	PGR7A	3200			BPR7EIX	4055					.025
		Sport	<b>PFR6B</b>	<b>3500</b>			BKR6EIX	6418	BKR6EGP	7092	BKR6E	6962	.025
<b>GTV-6</b>													
1986-85	V6 2.5L		BPR6ES	7131			BPR6EIX	6637	BPR6EGP	7084	BPR6EY	6427	.025
<b>Milano</b>													
1989-87	V6 2.5L		BPR6ES	7131			BPR6EIX	6637	BPR6EGP	7084	BPR6EY	6427	.025
	V6 3.0L		BPR7ES	5534			BPR7EIX	4055					.028
<b>Spider</b>													
1994-85	L4 2.0L		BPR7ES	5534			BPR7EIX	4055					.025
<b>AMERICAN MOTORS</b>													
<b>Eagle</b>													
1988-85	L6 4.2L		FR5-1	7252							FR5-1	7252	.035
<b>AM GENERAL</b>													
<b>Hummer</b>													
1996-95	V8 5.7L		UR5	2771			UR5IX	7177	UR5GP	3547	UR5	2771	.035
<b>ASTON MARTIN</b>													
<b>DB7</b>													
2004	V12 6.0L		<b>PTR5D-10</b>	<b>3784</b>	TR5AHX	94567	TR5IX	7397	TR5GP	3186	TR5	2238	.040
2003-02	V12 6.0L		<b>PTR5D-13</b>	<b>6644</b>	TR5AHX	94567	TR55IX	7164	TR55GP	3403	TR55	3951	.052
2000	V12 6.0L		<b>PTR6D-13</b>	<b>5598</b>	TR6AHX	92714	TR6IX	3689	TR6GP	5141	TR6	4177	.050
1998-97	L6 3.2L		BKR7E	4644							BKR7E	4644	.030
<b>DB9</b>													
2005	V12 6.0L		PFR6G-11	5555	FR6AHX-S	94279	BKR6EIX-11	3764	BKR6EGP	7092	BKR6E-11	2756	.040
<b>Lagonda</b>													
1989-85	V8 5.3L		BPR5ES	7734			BPR5EIX	6597	BPR5EGP	7082	BPR5EY	1233	.035
<b>V-8</b>													
1989-85	V8 5.3L		BPR5ES	7734			BPR5EIX	6597	BPR5EGP	7082	BPR5EY	1233	.035
<b>Vanquish</b>													
2006-02	V12 6.0L		<b>PTR6D-13</b>	<b>5598</b>	TR6AHX	92714	TR65IX	3692	TR6GP	5141	TR6	4177	.052
<b>Virage</b>													
1994-90	V8 5.3L		BCPR6ES	2330			BCPR6EIX	5689	BCPR6EGP	7088	BCPR6E	3735	.032
1989	V8 5.3L		BPR5ES	7734			BPR5EIX	6597	BPR5EGP	7082	BPR5EY	1233	.035
<b>Zagato</b>													
1988-87	V8 5.3L		BPR5ES	7734			BPR5EIX	6597	BPR5EGP	7082	BPR5EY	1233	.035
<b>ASUNA</b>													
<b>GT</b>													
1993	L4 1.6L		GR45	4268					GR45GP	3142	GR45	4268	.060
<b>SE</b>													
1993	L4 1.6L		GR45	4268					GR45GP	3142	GR45	4268	.060
<b>Sunrunner</b>													
1992	L4 1.6L		<b>BPR5ES</b>	<b>7734</b>			BPR5EIX	6597	BPR5EGP	7082	BPR5EY	1233	.032
<b>AUDI</b>													
<b>80</b>													
1992-91	L5 2.3L		<b>BPR5EKU</b>	<b>5685</b>									.032
1990-88	L4 2.0L		<b>BUR6ET</b>	<b>7517</b>									.032
<b>80 Quattro</b>													
1992	L5 2.3L		<b>BPR5EKU</b>	<b>5685</b>									.032
1991-88	L5 2.3L		BPR5EKU	5685									.032
<b>90</b>													
1995	V6 2.8L		<b>BKUR6ET-10</b>	<b>2397</b>									.040
1994	V6 2.8L	Eng Desg AAH	BKUR6ET-10	2397									.040
		Eng Desg AFC	<b>BKUR6ET-10</b>	<b>2397</b>									.040
1993	V6 2.8L		<b>BKUR6ET-10</b>	<b>2397</b>									.040
1991-89	L5 2.3L		BP6ET	1263									.032
1988	L4 2.0L		<b>BUR6ET</b>	<b>7517</b>									.032
	L5 2.3L		BP6ET	1263									.032



Year	Cyl. L	Notes	Original Equipment		Ruthenium HX		Iridium IX		G-Power		V-Power		Gap
			Part	Stock	Part	Stock	Part	Stock	Part	Stock	Part	Stock	
<b>AUDI (Cont'd)</b>													
<b>90 Quattro</b>													
1995-93	V6 2.8L		BKUR6ET-10	2397									.040
1992-90	L5 2.3L		BKR6E	6962			BKR6EIX	6418	BKR6EGP	7092	BKR6E	6962	.032
1989-88	L5 2.3L		BPR5EKU	5685									.032
<b>100</b>													
1994-92	V6 2.8L		BKUR6ET-10	2397									.040
1991-89	L5 2.3L		<b>BPR5EKU</b>	<b>5685</b>									.032
<b>100 Quattro</b>													
1994-92	V6 2.8L		BKUR6ET-10	2397									.040
1991-89	L5 2.3L		<b>BPR5EKU</b>	<b>5685</b>									.032
<b>200</b>													
1991-89	L5 2.2L		BP6ET	1263									.032
<b>200 Quattro</b>													
1991	L5 2.2L	Eng Desg 3B	PFR7B	4853			BKR7EIX	2667			BKR7E	4644	.025
		Eng Desg MC	BP6ET	1263									.032
1990-89	L5 2.2L		BP6ET	1263									.032
<b>4000</b>													
1987	L4 1.8L		BP6ET	1263									.032
1986-85	L4 1.8L		BP6ET	1263									.032
	L5 2.2L		BP6ET	1263									.032
<b>4000 Quattro</b>													
1987-86	L5 2.2L		BP6ET	1263			BPR6EIX	6637	BPR6EGP	7084			.032
1985	L5 2.2L		BP6ET	1263									.032
<b>5000</b>													
1988	L5 2.2L		BPR6ES	7131			BPR6EIX	6637	BPR6EGP	7084	BPR6EY	6427	.032
	L5 2.3L		BPR5EKU	5685									.032
1987	L5 2.2L	Vin B, Naturally Aspirated	BPR6ES	7131			BPR6EIX	6637	BPR6EGP	7084	BPR6EY	6427	.028
		Vin D, Turbo	BPR6ES	7131			BPR6EIX	6637	BPR6EGP	7084	BPR6EY	6427	.032
		Vin E, Turbo	PFR6Q	6458			BKR6EIX	6418					.032
	L5 2.3L		BPR5EKU	5685									.032
1986	L5 2.2L	Naturally Aspirated	BPR6ES	7131			BPR6EIX	6637	BPR6EGP	7084	BPR6EY	6427	.028
		Turbo	BPR6ES	7131			BPR6EIX	6637	BPR6EGP	7084	BPR6EY	6427	.032
1985	L5 2.0L	DIESEL	Y-918J	3704									
	L5 2.2L	Naturally Aspirated	BPR6ES	7131			BPR6EIX	6637	BPR6EGP	7084	BPR6EY	6427	.028
		Turbo	BPR7ES	5534			BPR7EIX	4055					.028
<b>5000 Quattro</b>													
1988-87	L5 2.2L		PFR6Q	6458			BKR6EIX	6418					.032
	L5 2.3L		BPR5EKU	5685									.032
1986	L5 2.2L	Vin D	BPR6ES	7131			BPR6EIX	6637	BPR6EGP	7084	BPR6EY	6427	.032
		Vin E	PFR6Q	6458			BKR6EIX	6418					.032
<b>A3</b>													
2017	L4 2.0L		<b>PLFER7A8EG</b>	<b>94833</b>	LFER7BHX	95125							.032
2016-15	L4 1.8L		<b>PLFER7A8EG</b>	<b>94833</b>	LFER7BHX	95125							.032
2013-10	L4 2.0L	GAS	<b>PFR7S8EG</b>	<b>1675</b>	FR7BHX-S	92400	BKR7EIX	2667					.032
2009	L4 2.0L		<b>PFR7S8EG</b>	<b>1675</b>	FR7BHX-S	92400	BKR7EIX	2667					.032
2008-06	L4 2.0L		PFR7S8EG	1675	FR7BHX-S	92400	BKR7EIX	2667					.032
<b>A3 Quattro</b>													
2017	L4 2.0L		<b>PLFER7A8EG</b>	<b>94833</b>	LFER7BHX	95125							.032
2016-15	L4 2.0L	GAS	<b>PLFER7A8EG</b>	<b>94833</b>	LFER7BHX	95125							.032
2013-12	L4 2.0L	GAS	<b>PFR7S8EG</b>	<b>1675</b>	FR7BHX-S	92400	BKR7EIX	2667					.032
2011-10	L4 2.0L		<b>PFR7S8EG</b>	<b>1675</b>	FR7BHX-S	92400	BKR7EIX	2667					.032
2009	L4 2.0L		<b>PFR7S8EG</b>	<b>1675</b>	FR7BHX-S	92400	BKR7EIX	2667					.032
	V6 3.2L		<b>IZKR7B</b>	<b>7563</b>									.036
2008-06	V6 3.2L		<b>IZKR7B</b>	<b>7563</b>									.036
<b>A4</b>													
2017	L4 2.0L		<b>PLFER7A8EG</b>	<b>94833</b>	LFER7BHX	95125							.032
2016-10	L4 2.0L		<b>PFR7S8EG</b>	<b>1675</b>	FR7BHX-S	92400	BKR7EIX	2667					.032

**Bold denotes NGK OE Manufacturer and/or OE Service Part**  
NOT BOLD denotes OE Equivalent Part

**Le texte en gras désigne une pièce d'équipement originale du manufacturier NGK et/ou pièce d'équipement originale de service**  
Le texte non en gras désigne une pièce d'équipement originale équivalente

Note: Due to different operating or engine conditions, alternate heat range plugs may be required.

Note: En raison de différences au niveau du fonctionnement ou des conditions du moteur, d'autres types de bougies avec variation de chaleur peuvent être nécessaires



Year	Cyl. L	Notes	Original Equipment		Ruthenium HX		Iridium IX		G-Power		V-Power		Gap
			Part	Stock	Part	Stock	Part	Stock	Part	Stock	Part	Stock	
<b>AUDI (Cont'd)</b>													
<b>A4 (Cont'd)</b>													
2009	L4 2.0L		PFR7S8EG	1675	FR7BHX-S	92400	BKR7EIX	2667					.032
2008-07	L4 2.0L		PFR7S8EG	1675	FR7BHX-S	92400	BKR7EIX	2667					.032
	V6 3.2L		<b>PFR7W-TG</b>	<b>5592</b>	FR7BHX-S	92400							.036
2006	L4 1.8L		<b>PFR6Q</b>	<b>6458</b>			BKR6EIX	6418					.032
	L4 2.0L		PFR7S8EG	1675	FR7BHX-S	92400	BKR7EIX	2667					.032
	V6 3.2L		<b>PFR7W-TG</b>	<b>5592</b>	FR7BHX-S	92400							.036
2005	L4 1.8L		<b>PFR6Q</b>	<b>6458</b>			BKR6EIX	6418					.032
	L4 2.0L		PFR7S8EG	1675	FR7BHX-S	92400	BKR7EIX	2667					.032
	V6 3.0L		<b>PFR6U-11G</b>	<b>5874</b>			BKR6EIX-11	3764	BKR6EGP	7092			.044
2004-02	L4 1.8L		<b>PFR6Q</b>	<b>6458</b>			BKR6EIX	6418					.032
	V6 3.0L		<b>PFR6U-11G</b>	<b>5874</b>			BKR6EIX-11	3764	BKR6EGP	7092			.044
2001	L4 1.8L		<b>PFR6Q</b>	<b>6458</b>			BKR6EIX	6418					.032
	V6 2.8L		<b>BKR6EKUB</b>	<b>7969</b>	FR6BHX-S	95159	BKR6EIX	6418	BKR6EGP	7092	BKR6E	6962	.032
2000	L4 1.8L		<b>PFR6Q</b>	<b>6458</b>			BKR6EIX	6418					.028
	V6 2.8L		<b>BKR6EKUB</b>	<b>7969</b>	FR6BHX-S	95159	BKR6EIX	6418	BKR6EGP	7092	BKR6E	6962	.032
1999	L4 1.8L		<b>BKUR6ET</b>	<b>7808</b>	FR6BHX-S	95159	BKR6EIX	6418			BKR6E	6962	.032
	V6 2.8L		<b>BKR6EKUB</b>	<b>7969</b>	FR6BHX-S	95159	BKR6EIX	6418	BKR6EGP	7092	BKR6E	6962	.032
1998	L4 1.8L		PFR6Q	6458			BKR6EIX	6418					.032
	V6 2.8L		<b>BKUR6ET-10</b>	<b>2397</b>	FR6BHX-S	95159							.040
1997	L4 1.8L		PFR6Q	6458			BKR6EIX	6418					.032
	V6 2.8L	Eng Desg AFC	<b>BKUR6ET-10</b>	<b>2397</b>	FR6BHX-S	95159			BKR6EGP	7092	BKR6E	6962	.040
		Eng Desg AHA	<b>BKR6EKUB</b>	<b>7969</b>	FR6BHX-S	95159	BKR6EIX	6418	BKR6EGP	7092	BKR6E	6962	.032
1996	V6 2.8L		<b>BKUR6ET</b>	<b>7808</b>			BKR6EIX	6418			BKR6E	6962	.032
<b>A4 allroad</b>													
2017	L4 2.0L		<b>PLFER7A8EG</b>	<b>94833</b>	LFER7BHX	95125							.032
2016-13	L4 2.0L		<b>PFR7S8EG</b>	<b>1675</b>	FR7BHX-S	92400	BKR7EIX	2667					.032
<b>A4 Quattro</b>													
2017	L4 2.0L		<b>PLFER7A8EG</b>	<b>94833</b>	LFER7BHX	95125							.032
2016-10	L4 2.0L		<b>PFR7S8EG</b>	<b>1675</b>	FR7BHX-S	92400	BKR7EIX	2667					.032
2009	L4 2.0L		PFR7S8EG	1675	FR7BHX-S	92400	BKR7EIX	2667					.032
	V6 3.2L	Eng Desg BKH Eng Desg CALA	<b>PFR7W-TG</b>	<b>5592</b>	FR7BHX-S	92400							.036
2008-07	L4 2.0L		PFR7S8EG	1675	FR7BHX-S	92400	BKR7EIX	2667					.032
	V6 3.2L		<b>PFR7W-TG</b>	<b>5592</b>	FR7BHX-S	92400							.036
2006	L4 2.0L		PFR7S8EG	1675	FR7BHX-S	92400	BKR7EIX	2667					.032
	V6 3.0L		<b>PFR6U-11G</b>	<b>5874</b>			BKR6EIX-11	3764	BKR6EGP	7092			.044
	V6 3.2L		<b>PFR7W-TG</b>	<b>5592</b>	FR7BHX-S	92400							.036
2005	L4 1.8L		<b>PFR6Q</b>	<b>6458</b>			BKR6EIX	6418					.032
	L4 2.0L		PFR7S8EG	1675	FR7BHX-S	92400	BKR7EIX	2667					.032
	V6 3.0L		<b>PFR6U-11G</b>	<b>5874</b>			BKR6EIX-11	3764	BKR6EGP	7092			.044
	V6 3.2L		<b>PFR7W-TG</b>	<b>5592</b>	FR7BHX-S	92400							.036
2004-02	L4 1.8L		<b>PFR6Q</b>	<b>6458</b>			BKR6EIX	6418					.032
	V6 3.0L		<b>PFR6U-11G</b>	<b>5874</b>			BKR6EIX-11	3764	BKR6EGP	7092			.044
2001	L4 1.8L		<b>PFR6Q</b>	<b>6458</b>			BKR6EIX	6418					.032
	V6 2.8L		<b>BKR6EKUB</b>	<b>7969</b>	FR6BHX-S	95159	BKR6EIX	6418	BKR6EGP	7092	BKR6E	6962	.032
2000	L4 1.8L	Eng Desg AEB	<b>BKUR6ET</b>	<b>7808</b>	FR6BHX-S	95159	BKR6EIX	6418			BKR6E	6962	.032
		Eng Desg ATW	<b>PFR6Q</b>	<b>6458</b>			BKR6EIX	6418					.028
	V6 2.8L		<b>BKR6EKUB</b>	<b>7969</b>	FR6BHX-S	95159	BKR6EIX	6418	BKR6EGP	7092	BKR6E	6962	.032
1999	L4 1.8L		<b>BKUR6ET</b>	<b>7808</b>	FR6BHX-S	95159	BKR6EIX	6418			BKR6E	6962	.032
	V6 2.8L		<b>BKR6EKUB</b>	<b>7969</b>	FR6BHX-S	95159	BKR6EIX	6418	BKR6EGP	7092	BKR6E	6962	.032
1998	L4 1.8L		PFR6Q	6458			BKR6EIX	6418					.032
	V6 2.8L		<b>BKR6EKUB</b>	<b>7969</b>	FR6BHX-S	95159	BKR6EIX	6418	BKR6EGP	7092	BKR6E	6962	.032
1997	L4 1.8L		PFR6Q	6458			BKR6EIX	6418					.032
	V6 2.8L		<b>BKUR6ET-10</b>	<b>2397</b>	FR6BHX-S	95159							.040
1996	V6 2.8L		<b>BKUR6ET</b>	<b>7808</b>			BKR6EIX	6418			BKR6E	6962	.032
<b>A5</b>													
2014-10	L4 2.0L		<b>PFR7S8EG</b>	<b>1675</b>	FR7BHX-S	92400	BKR7EIX	2667					.032



Year	Cyl. L	Notes	Original Equipment		Ruthenium HX		Iridium IX		G-Power		V-Power		Gap
			Part	Stock	Part	Stock	Part	Stock	Part	Stock	Part	Stock	
<b>AUDI (Cont'd)</b>													
<b>A5 Quattro</b>													
2017-11	L4 2.0L		<b>PFR7S8EG</b>	<b>1675</b>	FR7BHX-S	92400	BKR7EIX	2667					.032
2010	L4 2.0L		<b>PFR7S8EG</b>	<b>1675</b>	FR7BHX-S	92400	BKR7EIX	2667					.032
	V6 3.2L		<b>PFR6X-11</b>	<b>5757</b>			BKR6EIX-11	3764	BKR6EGP	7092			.044
2009-08	V6 3.2L		<b>PFR6X-11</b>	<b>5757</b>			BKR6EIX-11	3764	BKR6EGP	7092			.044
<b>A6</b>													
2017-16	L4 2.0L		<b>PLFER7A8EG</b>	<b>94833</b>	LFER7BHX	95125							.032
2015-12	L4 2.0L		<b>PFR7S8EG</b>	<b>1675</b>	FR7BHX-S	92400	BKR7EIX	2667					.032
2011-09	V6 3.2L		<b>PFR6X-11</b>	<b>5757</b>			BKR6EIX-11	3764	BKR6EGP	7092			.044
2008-06	V6 3.2L		<b>PFR7W-TG</b>	<b>5592</b>	FR7BHX-S	92400							.036
2004-02	V6 3.0L		<b>PFR6U-11G</b>	<b>5874</b>			BKR6EIX-11	3764	BKR6EGP	7092			.044
2001-99	V6 2.8L		<b>BKR6EKUB</b>	<b>7969</b>	FR6BHX-S	95159	BKR6EIX	6418	BKR6EGP	7092	BKR6E	6962	.032
1998	V6 2.8L	Eng Desg AHA	<b>BKR6EKUB</b>	<b>7969</b>	FR6BHX-S	95159	BKR6EIX	6418	BKR6EGP	7092	BKR6E	6962	.032
1997	V6 2.8L		<b>BKUR6ET-10</b>	<b>2397</b>	FR6BHX-S	95159							.040
1996-95	V6 2.8L		<b>BKUR6ET-10</b>	<b>2397</b>									.040
<b>A6 Quattro</b>													
2017	L4 2.0L		<b>PLFER7A8EG</b>	<b>94833</b>	LFER7BHX	95125							.032
	V6 3.0L		<b>PFR8S8EG</b>	<b>94460</b>									.032
2016	L4 2.0L		<b>PLFER7A8EG</b>	<b>94833</b>	LFER7BHX	95125							.032
	V6 3.0L	GAS	<b>PFR8S8EG</b>	<b>94460</b>									.032
2015-14	L4 2.0L		<b>PFR7S8EG</b>	<b>1675</b>	FR7BHX-S	92400	BKR7EIX	2667					.032
	V6 3.0L	GAS	<b>PFR8S8EG</b>	<b>94460</b>									.032
2013	L4 2.0L		<b>PFR7S8EG</b>	<b>1675</b>	FR7BHX-S	92400	BKR7EIX	2667					.032
	V6 3.0L		<b>PFR8S8EG</b>	<b>94460</b>									.032
2012	V6 3.0L		<b>PFR8S8EG</b>	<b>94460</b>									.032
2011-09	V6 3.0L		<b>PFR8S8EG</b>	<b>94460</b>									.032
	V8 4.2L		<b>PFR6W-TG</b>	<b>5547</b>									.036
2008-07	V6 3.2L		<b>PFR7W-TG</b>	<b>5592</b>	FR7BHX-S	92400							.036
	V8 4.2L		<b>PFR6W-TG</b>	<b>5547</b>									.036
2006-05	V6 3.2L		<b>PFR7W-TG</b>	<b>5592</b>	FR7BHX-S	92400							.036
	V8 4.2L		<b>PFR6G-11</b>	<b>5555</b>	FR6AHX-S	94279	BKR6EIX-11	3764	BKR6EGP	7092	BKR6E-11	2756	.040
2004-03	V6 2.7L		<b>PFR6Q</b>	<b>6458</b>			BKR6EIX	6418					.032
	V6 3.0L		<b>PFR6U-11G</b>	<b>5874</b>			BKR6EIX-11	3764	BKR6EGP	7092			.044
	V8 4.2L		<b>BKR6EQUA</b>	<b>5767</b>	FR6AHX-S	94279	BKR6EIX	6418	BKR6EGP	7092	BKR6E	6962	.032
2002	V6 2.7L		<b>PFR6Q</b>	<b>6458</b>			BKR6EIX	6418					.032
	V6 3.0L		<b>PFR6U-11G</b>	<b>5874</b>			BKR6EIX-11	3764	BKR6EGP	7092			.044
	V8 4.2L		<b>BKR6EKUB</b>	<b>7969</b>	FR6AHX-S	94279	BKR6EIX	6418	BKR6EGP	7092	BKR6E	6962	.032
2001-00	V6 2.7L		<b>PFR6Q</b>	<b>6458</b>			BKR6EIX	6418					.032
	V6 2.8L		<b>BKR6EKUB</b>	<b>7969</b>	FR6BHX-S	95159	BKR6EIX	6418	BKR6EGP	7092	BKR6E	6962	.032
	V8 4.2L		<b>BKR6EKUB</b>	<b>7969</b>	FR6AHX-S	94279	BKR6EIX	6418	BKR6EGP	7092	BKR6E	6962	.032
1999-98	V6 2.8L		<b>BKR6EKUB</b>	<b>7969</b>	FR6BHX-S	95159	BKR6EIX	6418	BKR6EGP	7092	BKR6E	6962	.032
1997	V6 2.8L		<b>BKUR6ET-10</b>	<b>2397</b>	FR6BHX-S	95159							.040
1996	V6 2.8L		<b>BKUR6ET</b>	<b>7808</b>			BKR6EIX	6418			BKR6E	6962	.032
1995	V6 2.8L		<b>BKUR6ET</b>	<b>7808</b>			BKR6EIX	6418			BKR6E	6962	.032
<b>A7 Quattro</b>													
2017	V6 3.0L		<b>PFR8S8EG</b>	<b>94460</b>									.032
2016-14	V6 3.0L	GAS	<b>PFR8S8EG</b>	<b>94460</b>									.032
2013-12	V6 3.0L		<b>PFR8S8EG</b>	<b>94460</b>									.032
<b>A8 Quattro</b>													
2017	V6 3.0L	GAS	<b>PFR8S8EG</b>	<b>94460</b>									.032
2016-14	V6 3.0L	GAS	<b>PFR8S8EG</b>	<b>94460</b>									.032
	W12 6.3L		<b>ILZKR8A</b>	<b>94290</b>									.032
2013	V6 3.0L		<b>PFR8S8EG</b>	<b>94460</b>									.032
	W12 6.3L		<b>ILZKR8A</b>	<b>94290</b>									.032
2012	V8 4.2L		<b>PFR6W-TG</b>	<b>5547</b>									.036
	W12 6.3L		<b>ILZKR8A</b>	<b>94290</b>									.032

**Bold denotes NGK OE Manufacturer and/or OE Service Part**  
NOT BOLD denotes OE Equivalent Part

**Le texte en gras désigne une pièce d'équipement originale du manufacturier NGK et/ou pièce d'équipement originale de service**  
Le texte non en gras désigne une pièce d'équipement originale équivalente

Note: Due to different operating or engine conditions, alternate heat range plugs may be required.

Note: En raison de différences au niveau du fonctionnement ou des conditions du moteur, d'autres types de bougies avec variation de chaleur peuvent être nécessaires





Year	Cyl. L	Notes	Original Equipment		Ruthenium HX		Iridium IX		G-Power		V-Power		Gap
			Part	Stock	Part	Stock	Part	Stock	Part	Stock	Part	Stock	
<b>AUDI (Cont'd)</b>													
<b>A8 Quattro (Cont'd)</b>													
2011-10	V8 4.2L		<b>PFR6W-TG</b>	<b>5547</b>									.036
2009-07	V8 4.2L		<b>PFR6W-TG</b>	<b>5547</b>									.036
	W12 6.0L		<b>PZFR6J-11</b>	<b>3586</b>									.044
2006-05	V8 4.2L		<b>BKR6EQUP</b>	<b>3199</b>	FR6AHX-S	94279	BKR6EIX	6418	BKR6EGP	7092	BKR6E	6962	.032
	W12 6.0L		<b>PZFR6J-11</b>	<b>3586</b>									.044
2004	V8 4.2L		<b>BKR6EQUP</b>	<b>3199</b>	FR6AHX-S	94279	BKR6EIX	6418	BKR6EGP	7092	BKR6E	6962	.032
2003	V8 4.2L	Eng Desg AKB	<b>BKR6EQUP</b>	<b>3199</b>	FR6AHX-S	94279	BKR6EIX	6418	BKR6EGP	7092	BKR6E	6962	.032
		Eng Desg AUX	BKR6EKUB	7969	FR6AHX-S	94279	BKR6EIX	6418	BKR6EGP	7092	BKR6E	6962	.032
2002-97	V8 4.2L		BKR6EKUB	7969	FR6AHX-S	94279	BKR6EIX	6418	BKR6EGP	7092	BKR6E	6962	.032
<b>allroad</b>													
2016	L4 2.0L		<b>PLFER7A8EG</b>	<b>94833</b>	LFER7BHX	95125							.032
2015-13	L4 2.0L		<b>PFR7S8EG</b>	<b>1675</b>	FR7BHX-S	92400	BKR7EIX	2667					.032
<b>Allroad Quattro</b>													
2005-03	V6 2.7L		<b>PFR6Q</b>	<b>6458</b>			BKR6EIX	6418					.032
	V8 4.2L		BKR6EQUA	5767	FR6AHX-S	94279	BKR6EIX	6418	BKR6EGP	7092	BKR6E	6962	.032
2002-01	V6 2.7L		<b>PFR6Q</b>	<b>6458</b>			BKR6EIX	6418					.032
<b>Cabriolet</b>													
1998	V6 2.8L		<b>BKUR6ET-10</b>	<b>2397</b>	FR6BHX-S	95159							.040
1997	V6 2.8L		BKUR6ET-10	2397	FR6BHX-S	95159							.040
1996	V6 2.8L		<b>BKUR6ET</b>	<b>7808</b>			BKR6EIX	6418			BKR6E	6962	.032
1995	V6 2.8L		BKUR6ET	7808			BKR6EIX	6418			BKR6E	6962	.032
1994	V6 2.8L		BKUR6ET-10	2397									.040
<b>Coupe</b>													
1987	L5 2.2L		BPR6ES	7131			BPR6EIX	6637	BPR6EGP	7084	BPR6EY	6427	.028
	L5 2.3L		BPR6ES	7131			BPR6EIX	6637	BPR6EGP	7084	BPR6EY	6427	.028
1986-85	L5 2.2L		BPR6ES	7131			BPR6EIX	6637	BPR6EGP	7084	BPR6EY	6427	.028
<b>Coupe Quattro</b>													
1991-90	L5 2.3L		BKR6E	6962			BKR6EIX	6418	BKR6EGP	7092	BKR6E	6962	.032
<b>Q3</b>													
2017-15	L4 2.0L		<b>PFR7S8EG</b>	<b>1675</b>	FR7BHX-S	92400	BKR7EIX	2667					.032
<b>Q3 Quattro</b>													
2017-15	L4 2.0L		<b>PFR7S8EG</b>	<b>1675</b>	FR7BHX-S	92400	BKR7EIX	2667					.032
<b>Q5</b>													
2017-13	L4 2.0L		<b>PFR7S8EG</b>	<b>1675</b>	FR7BHX-S	92400	BKR7EIX	2667					.032
	V6 3.0L	GAS	<b>PFR8S8EG</b>	<b>94460</b>									.032
2012-11	L4 2.0L		<b>PFR7S8EG</b>	<b>1675</b>	FR7BHX-S	92400	BKR7EIX	2667					.032
	V6 3.2L		<b>PFR6X-11</b>	<b>5757</b>			BKR6EIX-11	3764	BKR6EGP	7092			.044
2010-09	V6 3.2L		<b>PFR6X-11</b>	<b>5757</b>			BKR6EIX-11	3764	BKR6EGP	7092			.044
<b>Q7</b>													
2017	L4 2.0L		<b>PLFER7A8EG</b>	<b>94833</b>	LFER7BHX	95125							.032
	V6 3.0L	GAS	<b>PFR8S8EG</b>	<b>94460</b>									.032
2015-11	V6 3.0L	GAS	<b>PFR8S8EG</b>	<b>94460</b>									.032
2010-07	V6 3.6L		<b>ILZKR7A</b>	<b>1961</b>									.036
	V8 4.2L		<b>PFR6W-TG</b>	<b>5547</b>									.036
<b>Quattro</b>													
1986-85	L5 2.2L		BPR7ES	5534			BPR7EIX	4055					.028
<b>R8</b>													
2017	V10 5.2L		<b>PFR7S8EG</b>	<b>1675</b>	FR7BHX-S	92400	BKR7EIX	2667					.032
2015-14	V8 4.2L		<b>PFR7S8EG</b>	<b>1675</b>	FR7BHX-S	92400	BKR7EIX	2667					.032
	V10 5.2L		<b>PFR7S8EG</b>	<b>1675</b>	FR7BHX-S	92400	BKR7EIX	2667					.032
2012-11	V8 4.2L		<b>PFR7S8EG</b>	<b>1675</b>	FR7BHX-S	92400	BKR7EIX	2667					.032
	V10 5.2L		<b>PFR7S8EG</b>	<b>1675</b>	FR7BHX-S	92400	BKR7EIX	2667					.032
2010-09	V8 4.2L		<b>PFR7W-TG</b>	<b>5592</b>	FR7BHX-S	92400							.036
	V10 5.2L		<b>PFR7W-TG</b>	<b>5592</b>	FR7BHX-S	92400							.036
2008	V8 4.2L		<b>PFR7W-TG</b>	<b>5592</b>	FR7BHX-S	92400							.036



Year	Cyl. L	Notes	Original Equipment		Ruthenium HX		Iridium IX		G-Power		V-Power		Gap
			Part	Stock	Part	Stock	Part	Stock	Part	Stock	Part	Stock	
<b>AUDI (Cont'd)</b>													
<b>RS4</b>													
2008-07	V8 4.2L		<b>PFR7W-TG</b>	<b>5592</b>	FR7BHX-S	92400							.036
<b>RS5</b>													
2015-13	V8 4.2L		<b>PFR7S8EG</b>	<b>1675</b>	FR7BHX-S	92400	BKR7EIX	2667					.032
<b>RS6</b>													
2004-03	V8 4.2L		<b>PFR7Q</b>	<b>7963</b>	FR7BHX-S	92400	BKR7EIX	2667					.032
<b>S3</b>													
2017	L4 2.0L		<b>PLFER7A8EG</b>	<b>94833</b>	LFER7BHX	95125							.032
2016-15	L4 2.0L	GAS	<b>PLFER7A8EG</b>	<b>94833</b>	LFER7BHX	95125							.032
<b>S4</b>													
2016-10	V6 3.0L		<b>PFR8S8EG</b>	<b>94460</b>									.032
2009-04	V8 4.2L		<b>BKR6EQUA</b>	<b>5767</b>	FR6AHX-S	94279	BKR6EIX	6418	BKR6EGP	7092	BKR6E	6962	.032
2002-00	V6 2.7L		<b>PFR6Q</b>	<b>6458</b>			BKR6EIX	6418					.032
1994-92	L5 2.2L		PFR7B	4853			BKR7EIX	2667			BKR7E	4644	.025
<b>S5</b>													
2017-13	V6 3.0L		<b>PFR8S8EG</b>	<b>94460</b>									.032
2012-10	V6 3.0L		<b>PFR8S8EG</b>	<b>94460</b>									.032
	V8 4.2L		<b>PFR6W-TG</b>	<b>5547</b>									.036
2009-08	V8 4.2L		<b>PFR6W-TG</b>	<b>5547</b>									.036
<b>S6</b>													
2011-07	V10 5.2L		<b>PFR6W-TG</b>	<b>5547</b>									.032
2003	V8 4.2L		BKR6EQUA	5767	FR6AHX-S	94279	BKR6EIX	6418	BKR6EGP	7092	BKR6E	6962	.032
2002	V8 4.2L		BKR6EKUB	7969	FR6AHX-S	94279	BKR6EIX	6418	BKR6EGP	7092	BKR6E	6962	.032
1997	L5 2.2L		BKR7E	4644			BKR7EIX	2667			BKR7E	4644	.025
1996	L5 2.2L		PFR7B	4853			BKR7EIX	2667			BKR7E	4644	.025
1995	L5 2.2L		BKR7E	4644			BKR7EIX	2667			BKR7E	4644	.025
<b>S8</b>													
2009-07	V10 5.2L		<b>PFR6W-TG</b>	<b>5547</b>									.036
2003	V8 4.2L		BKR6ES	6364	FR6AHX-S	94279	BKR6EIX	6418	BKR6EGP	7092	BKR6E	6962	.032
2002-01	V8 4.2L		BKR6EKUB	7969	FR6AHX-S	94279	BKR6EIX	6418	BKR6EGP	7092	BKR6E	6962	.032
<b>SQ5</b>													
2017-14	V6 3.0L	GAS	<b>PFR8S8EG</b>	<b>94460</b>									.032
<b>TT</b>													
2009	L4 2.0L	Eng Desg BPY	<b>PFR7S8EG</b>	<b>1675</b>	FR7BHX-S	92400	BKR7EIX	2667					.032
		Eng Desg CCTA	PFR7S8EG	1675	FR7BHX-S	92400	BKR7EIX	2667					.032
2008	L4 2.0L		<b>PFR7S8EG</b>	<b>1675</b>	FR7BHX-S	92400	BKR7EIX	2667					.032
2006-04	L4 1.8L		<b>PFR6Q</b>	<b>6458</b>			BKR6EIX	6418					.032
2003	L4 1.8L		<b>IZKR7B</b>	<b>7563</b>									.036
2002	L4 1.8L		<b>PFR6Q</b>	<b>6458</b>			BKR6EIX	6418					.032
2001	L4 1.8L	Eng Desg ATC	<b>PFR6Q</b>	<b>6458</b>			BKR6EIX	6418					.032
		Eng Desg AWP	<b>PFR6Q</b>	<b>6458</b>			BKR6EIX	6418					.032
2000	L4 1.8L		<b>PFR6Q</b>	<b>6458</b>			BKR6EIX	6418					.032
<b>TT Quattro</b>													
2017-16	L4 2.0L		<b>PLFER7A8EG</b>	<b>94833</b>	LFER7BHX	95125							.032
2015-10	L4 2.0L		<b>PFR7S8EG</b>	<b>1675</b>	FR7BHX-S	92400	BKR7EIX	2667					.032
2009	L4 2.0L		PFR7S8EG	1675	FR7BHX-S	92400	BKR7EIX	2667					.032
	V6 3.2L		<b>IZKR7B</b>	<b>7563</b>									.036
2008	V6 3.2L		<b>IZKR7B</b>	<b>7563</b>									.036
2006-04	L4 1.8L		<b>PFR6Q</b>	<b>6458</b>			BKR6EIX	6418					.032
	V6 3.2L		<b>IZKR7B</b>	<b>7563</b>									.036
2003-00	L4 1.8L		<b>PFR6Q</b>	<b>6458</b>			BKR6EIX	6418					.032
<b>V8 Quattro</b>													
1991-90	V8 3.6L		TR5	2238			TR5IX	7397	TR5GP	3186	TR5	2238	.030
<b>BENTLEY</b>													
<b>Amage</b>													
2009-02	V8 6.8L		BKR5EIX	6341	FR5BHX	96457	BKR5EIX	6341	BKR5EGP	7090	BKR5E	7938	.036
2001-00	V8 4.4L		BKR5EGP	7090	FR5BHX	96457	BKR5EIX	6341	BKR5EGP	7090	BKR5E	7938	.032
	V8 6.8L		BKR5EIX	6341	FR5BHX	96457	BKR5EIX	6341	BKR5EGP	7090	BKR5E	7938	.036

**Bold denotes NGK OE Manufacturer and/or OE Service Part**  
 NOT BOLD denotes OE Equivalent Part

Note: Due to different operating or engine conditions, alternate heat range plugs may be required.

**Le texte en gras désigne une pièce d'équipement originale du manufacturier NGK et/ou pièce d'équipement originale de service**  
 Le texte non en gras désigne une pièce d'équipement originale équivalente

Note: En raison de différences au niveau du fonctionnement ou des conditions du moteur, d'autres types de bougies avec variation de chaleur peuvent être nécessaires



Year	Cyl. L	Notes	Original Equipment		Ruthenium HX		Iridium IX		G-Power		V-Power		Gap
			Part	Stock	Part	Stock	Part	Stock	Part	Stock	Part	Stock	
<b>BENTLEY (Cont'd)</b>													
Arnage (Cont'd)													
1999	V8 4.4L		<b>BKR6EQP</b>	<b>3199</b>	FR6BHX-S	95159	BKR6EIX	6418	BKR6EGP	7092	BKR6E	6962	.032
Azure													
2008-06	V8 6.8L		BKR5EIX	6341	FR5BHX	96457	BKR5EIX	6341	BKR5EGP	7090	BKR5E	7938	.036
2003-99	V8 6.8L		BKR5EIX	6341	FR5BHX	96457	BKR5EIX	6341	BKR5EGP	7090	BKR5E	7938	.032
1998-97	V8 6.8L		BKR5E	7938	FR5BHX	96457	BKR5EIX	6341	BKR5EGP	7090	BKR5E	7938	.032
1996	V8 6.8L		BKR5E	7938			BKR5EIX	6341	BKR5EGP	7090	BKR5E	7938	.032
Brooklands													
1998-97	V8 6.8L		BKR5E	7938	FR5BHX	96457	BKR5EIX	6341	BKR5EGP	7090	BKR5E	7938	.036
1996-93	V8 6.8L		BKR5E	7938			BKR5EIX	6341	BKR5EGP	7090	BKR5E	7938	.036
Continental													
2010-04	W12 6.0L		<b>PZFR6J-11</b>	<b>3586</b>									.044
2003	V8 6.8L		BKR5E	7938	FR5BHX	96457	BKR5EIX	6341	BKR5EGP	7090	BKR5E	7938	.036
	W12 6.0L		<b>PZFR6J-11</b>	<b>3586</b>									.044
2002-97	V8 6.8L		BKR5E	7938	FR5BHX	96457	BKR5EIX	6341	BKR5EGP	7090	BKR5E	7938	.036
1996-85	V8 6.8L		BKR5E	7938			BKR5EIX	6341	BKR5EGP	7090	BKR5E	7938	.036
Eight													
1991-86	V8 6.8L		BKR5ES	2460			BKR5EIX	6341	BKR5EGP	7090	BKR5E	7938	.036
Mulsanne													
1992-85	V8 6.8L		BKR5ES	2460			BKR5EIX	6341	BKR5EGP	7090	BKR5E	7938	.036
Turbo R													
1998-97	V8 6.8L		BKR5ES	2460	FR5BHX	96457	BKR5EIX	6341	BKR5EGP	7090	BKR5E	7938	.036
1996-88	V8 6.8L		BKR5ES	2460			BKR5EIX	6341	BKR5EGP	7090	BKR5E	7938	.036
<b>BERTONE</b>													
X-1/9													
1989-86	L4 1.5L		BPR6ES	7131			BPR6EIX	6637	BPR6EGP	7084	BPR6EY	6427	.028
1985	L4 1.5L		BPR6ES	7131			BPR6EIX	6637	BPR6EGP	7084	BPR6EY	6427	.028
	L4 2.0L		BPR6ES	7131			BPR6EIX	6637	BPR6EGP	7084	BPR6EY	6427	.028
<b>BMW</b>													
128i													
2013-10	L6 3.0L		<b>LZFR6AP11GS</b>	<b>95712</b>	LFR6AHX-S	94122							.044
2009-08	L6 3.0L		<b>PLZFR6A-11S</b>	<b>5987</b>	LFR6AHX-S	94122	LFR6AIX-11	6619	LFR6CGP	1483	LFR6C-11	7787	.044
135i													
2013-11	L6 3.0L		SILZKBR8D8S	97506									.032
135is													
2013	L6 3.0L		SILZKBR8D8S	97506									.032
228i													
2016	L4 2.0L		<b>SILZKBR8D8S</b>	<b>97506</b>									.032
2015	L4 2.0L	From 3/2015	<b>SILZKBR8D8S</b>	<b>97506</b>									.032
		To 3/2015	<b>SILZKBR8D8S</b>	<b>97506</b>									.032
2014	L4 2.0L		<b>SILZKBR8D8S</b>	<b>97506</b>									.032
228i xDrive													
2016	L4 2.0L		<b>SILZKBR8D8S</b>	<b>97506</b>									.032
2015	L4 2.0L	From 3/2015	<b>SILZKBR8D8S</b>	<b>97506</b>									.032
		To 3/2015	<b>SILZKBR8D8S</b>	<b>97506</b>									.032
230i													
2017	L4 2.0L		<b>SILZKGR8B8S</b>	<b>94201</b>									.030
230i xDrive													
2017	L4 2.0L		<b>SILZKGR8B8S</b>	<b>94201</b>									.030
318i													
1999-97	L4 1.9L		<b>BKR6EK</b>	<b>2288</b>	FR6AHX-S	94279	BKR6EIX	6418	BKR6EGP	7092	BKR6E	6962	.032
1996	L4 1.9L		<b>BKR6EK</b>	<b>2288</b>			BKR6EIX	6418	BKR6EGP	7092	BKR6E	6962	.032
1995-91	L4 1.8L		<b>BKR6EK</b>	<b>2288</b>			BKR6EIX	6418	BKR6EGP	7092	BKR6E	6962	.032
1985	L4 1.8L		BPR5ES	7734			BPR5EIX	6597	BPR5EGP	7082	BPR5EY	1233	.036
318is													
1999-97	L4 1.9L		<b>BKR6EK</b>	<b>2288</b>	FR6AHX-S	94279	BKR6EIX	6418	BKR6EGP	7092	BKR6E	6962	.032



Year	Cyl. L	Notes	Original Equipment		Ruthenium HX		Iridium IX		G-Power		V-Power		Gap
			Part	Stock	Part	Stock	Part	Stock	Part	Stock	Part	Stock	
<b>BMW (Cont'd)</b>													
<b>318is (Cont'd)</b>													
1996	L4 1.9L		<b>BKR6EK</b>	<b>2288</b>			BKR6EIX	6418	BKR6EGP	7092	BKR6E	6962	.032
1995-91	L4 1.8L		<b>BKR6EK</b>	<b>2288</b>			BKR6EIX	6418	BKR6EGP	7092	BKR6E	6962	.032
<b>318ti</b>													
1999-97	L4 1.9L		<b>BKR6EK</b>	<b>2288</b>	FR6AHX-S	94279	BKR6EIX	6418	BKR6EGP	7092	BKR6E	6962	.032
1996	L4 1.9L		<b>BKR6EK</b>	<b>2288</b>			BKR6EIX	6418	BKR6EGP	7092	BKR6E	6962	.032
1995	L4 1.8L		<b>BKR6EK</b>	<b>2288</b>			BKR6EIX	6418	BKR6EGP	7092	BKR6E	6962	.032
<b>320i</b>													
2018-16	L4 2.0L		<b>SILZKBR8D8S</b>	<b>97506</b>									.032
2015	L4 2.0L	From 3/2015	<b>SILZKBR8D8S</b>	<b>97506</b>									.032
		To 3/2015	<b>SILZKBR8D8S</b>	<b>97506</b>									.032
2014-12	L4 2.0L		<b>SILZKBR8D8S</b>	<b>97506</b>									.032
2005-01	L6 2.2L		<b>BKR6EQUP</b>	<b>3199</b>	FR6AHX-S	94279	BKR6EIX	6418	BKR6EGP	7092	BKR6E	6962	.032
1995-92	L6 2.0L		<b>BKR6EQUP</b>	<b>3199</b>			BKR6EIX	6418	BKR6EGP	7092	BKR6E	6962	.032
<b>320i xDrive</b>													
2018-16	L4 2.0L		<b>SILZKBR8D8S</b>	<b>97506</b>									.032
2015	L4 2.0L	From 3/2015	<b>SILZKBR8D8S</b>	<b>97506</b>									.032
		To 3/2015	<b>SILZKBR8D8S</b>	<b>97506</b>									.032
2014-13	L4 2.0L		<b>SILZKBR8D8S</b>	<b>97506</b>									.032
<b>323Ci</b>													
2000	L6 2.5L		<b>BKR6EQUP</b>	<b>3199</b>	FR6AHX-S	94279	BKR6EIX	6418	BKR6EGP	7092	BKR6E	6962	.032
<b>323i</b>													
2011-10	L6 2.5L		<b>LZFR6AP11GS</b>	<b>95712</b>	LF6AHX-S	94122							.044
2009-08	L6 2.5L		<b>PLZFR6A-11S</b>	<b>5987</b>	LF6AHX-S	94122	LF6AIX-11	6619	LF6CGP	1483	LF6C-11	7787	.044
2007-06	L6 2.5L		<b>ILZFR6D11</b>	<b>1208</b>	LF6AHX-S	94122	LF6AIX-11	6619	LF6CGP	1483	LF6C-11	7787	.044
2000-98	L6 2.5L		<b>BKR6EQUP</b>	<b>3199</b>	FR6AHX-S	94279	BKR6EIX	6418	BKR6EGP	7092	BKR6E	6962	.032
<b>323is</b>													
1999-98	L6 2.5L		<b>BKR6EQUP</b>	<b>3199</b>	FR6AHX-S	94279	BKR6EIX	6418	BKR6EGP	7092	BKR6E	6962	.032
<b>325</b>													
1988-86	L6 2.7L		ZGR5A	5077							ZGR5A	5077	.028
<b>325Ci</b>													
2006-01	L6 2.5L		<b>BKR6EQUP</b>	<b>3199</b>	FR6AHX-S	94279	BKR6EIX	6418	BKR6EGP	7092	BKR6E	6962	.032
<b>325e</b>													
1987-85	L6 2.7L		ZGR5A	5077							ZGR5A	5077	.028
<b>325es</b>													
1987-86	L6 2.7L		ZGR5A	5077							ZGR5A	5077	.028
<b>325i</b>													
2006	L6 3.0L		<b>ILZFR6D11</b>	<b>1208</b>	LF6AHX-S	94122	LF6AIX-11	6619	LF6CGP	1483	LF6C-11	7787	.044
2005-01	L6 2.5L		<b>BKR6EQUP</b>	<b>3199</b>	FR6AHX-S	94279	BKR6EIX	6418	BKR6EGP	7092	BKR6E	6962	.032
1995-94	L6 2.5L		<b>BKR6EK</b>	<b>2288</b>			BKR6EIX	6418	BKR6EGP	7092	BKR6E	6962	.032
1993	L6 2.5L	Eng Desg M20	ZGR5A	5077							ZGR5A	5077	.028
		Eng Desg M50TU	<b>BKR6EK</b>	<b>2288</b>			BKR6EIX	6418	BKR6EGP	7092	BKR6E	6962	.032
1992	L6 2.5L	Eng Desg M20	ZGR5A	5077							ZGR5A	5077	.028
		Eng Desg M50	<b>BKR6EK</b>	<b>2288</b>			BKR6EIX	6418	BKR6EGP	7092	BKR6E	6962	.032
1991-87	L6 2.5L		ZGR5A	5077							ZGR5A	5077	.028
<b>325is</b>													
1995-92	L6 2.5L		<b>BKR6EK</b>	<b>2288</b>			BKR6EIX	6418	BKR6EGP	7092	BKR6E	6962	.032
1991-87	L6 2.5L		ZGR5A	5077							ZGR5A	5077	.028
<b>325iX</b>													
1991-88	L6 2.5L		ZGR5A	5077							ZGR5A	5077	.032
<b>325xi</b>													
2006	L6 3.0L		<b>ILZFR6D11</b>	<b>1208</b>	LF6AHX-S	94122	LF6AIX-11	6619	LF6CGP	1483	LF6C-11	7787	.044
2005-01	L6 2.5L		<b>BKR6EQUP</b>	<b>3199</b>	FR6AHX-S	94279	BKR6EIX	6418	BKR6EGP	7092	BKR6E	6962	.032
<b>328Ci</b>													
2000	L6 2.8L		<b>BKR6EQUP</b>	<b>3199</b>	FR6AHX-S	94279	BKR6EIX	6418	BKR6EGP	7092	BKR6E	6962	.032
<b>328i</b>													
2016	L4 2.0L		<b>SILZKBR8D8S</b>	<b>97506</b>									.032
2015	L4 2.0L	From 3/2015	<b>SILZKBR8D8S</b>	<b>97506</b>									.032

**Bold denotes NGK OE Manufacturer and/or OE Service Part**  
NOT BOLD denotes OE Equivalent Part

**Le texte en gras désigne une pièce d'équipement originale du manufacturier NGK et/ou pièce d'équipement originale de service**  
Le texte non en gras désigne une pièce d'équipement originale équivalente

Note: Due to different operating or engine conditions, alternate heat range plugs may be required.

Note: En raison de différences au niveau du fonctionnement ou des conditions du moteur, d'autres types de bougies avec variation de chaleur peuvent être nécessaires



Year	Cyl. L	Notes	Original Equipment		Ruthenium HX		Iridium IX		G-Power		V-Power		Gap
			Part	Stock	Part	Stock	Part	Stock	Part	Stock	Part	Stock	
<b>BMW (Cont'd)</b>													
<b>328i (Cont'd)</b>													
2015		To 3/2015	<b>SILZKBR8D8S</b>	<b>97506</b>									.032
2014	L4 2.0L		<b>SILZKBR8D8S</b>	<b>97506</b>									.032
2013-12	L4 2.0L		<b>SILZKBR8D8S</b>	<b>97506</b>									.032
	L6 3.0L		<b>LZFR6AP11GS</b>	<b>95712</b>	LFR6AHX-S	94122							.044
2011-10	L6 3.0L		<b>LZFR6AP11GS</b>	<b>95712</b>	LFR6AHX-S	94122							.044
2009-08	L6 3.0L		<b>PLZFR6A-11S</b>	<b>5987</b>	LFR6AHX-S	94122	LFR6AIX-11	6619	LFR6CGP	1483	LFR6C-11	7787	.044
2007	L6 3.0L		<b>ILZFR6D11</b>	<b>1208</b>	LFR6AHX-S	94122	LFR6AIX-11	6619	LFR6CGP	1483	LFR6C-11	7787	.044
2000-97	L6 2.8L		<b>BKR6EQUP</b>	<b>3199</b>	FR6AHX-S	94279	BKR6EIX	6418	BKR6EGP	7092	BKR6E	6962	.032
1996	L6 2.8L		<b>BKR6EQUP</b>	<b>3199</b>			BKR6EIX	6418	BKR6EGP	7092	BKR6E	6962	.032
<b>328i GT xDrive</b>													
2016	L4 2.0L		<b>SILZKBR8D8S</b>	<b>97506</b>									.032
2015	L4 2.0L	From 3/2015	<b>SILZKBR8D8S</b>	<b>97506</b>									.032
		To 3/2015	<b>SILZKBR8D8S</b>	<b>97506</b>									.032
2014	L4 2.0L		<b>SILZKBR8D8S</b>	<b>97506</b>									.032
<b>328is</b>													
1999-97	L6 2.8L		<b>BKR6EQUP</b>	<b>3199</b>	FR6AHX-S	94279	BKR6EIX	6418	BKR6EGP	7092	BKR6E	6962	.032
1996	L6 2.8L		<b>BKR6EQUP</b>	<b>3199</b>			BKR6EIX	6418	BKR6EGP	7092	BKR6E	6962	.032
<b>328i xDrive</b>													
2016	L4 2.0L		<b>SILZKBR8D8S</b>	<b>97506</b>									.032
2015	L4 2.0L	From 3/2015	<b>SILZKBR8D8S</b>	<b>97506</b>									.032
		To 3/2015	<b>SILZKBR8D8S</b>	<b>97506</b>									.032
2014	L4 2.0L		<b>SILZKBR8D8S</b>	<b>97506</b>									.032
2013	L4 2.0L		<b>SILZKBR8D8S</b>	<b>97506</b>									.032
	L6 3.0L		<b>LZFR6AP11GS</b>	<b>95712</b>	LFR6AHX-S	94122							.044
2012-10	L6 3.0L		<b>LZFR6AP11GS</b>	<b>95712</b>	LFR6AHX-S	94122							.044
2009	L6 3.0L		<b>PLZFR6A-11S</b>	<b>5987</b>	LFR6AHX-S	94122	LFR6AIX-11	6619	LFR6CGP	1483	LFR6C-11	7787	.044
<b>328xi</b>													
2008	L6 3.0L		<b>PLZFR6A-11S</b>	<b>5987</b>	LFR6AHX-S	94122	LFR6AIX-11	6619	LFR6CGP	1483	LFR6C-11	7787	.044
2007	L6 3.0L		<b>ILZFR6D11</b>	<b>1208</b>	LFR6AHX-S	94122	LFR6AIX-11	6619	LFR6CGP	1483	LFR6C-11	7787	.044
<b>330Ci</b>													
2006-01	L6 3.0L		<b>BKR6EQUP</b>	<b>3199</b>	FR6AHX-S	94279	BKR6EIX	6418	BKR6EGP	7092	BKR6E	6962	.032
<b>330e</b>													
2018-16	L4 2.0L		<b>SILZKGR8B8S</b>	<b>94201</b>									.030
<b>330i</b>													
2018-17	L4 2.0L		<b>SILZKGR8B8S</b>	<b>94201</b>									.030
2006	L6 3.0L		<b>ILZFR6D11</b>	<b>1208</b>	LFR6AHX-S	94122	LFR6AIX-11	6619	LFR6CGP	1483	LFR6C-11	7787	.044
2005-01	L6 3.0L		<b>BKR6EQUP</b>	<b>3199</b>	FR6AHX-S	94279	BKR6EIX	6418	BKR6EGP	7092	BKR6E	6962	.032
<b>330i GT xDrive</b>													
2018-17	L4 2.0L		<b>SILZKGR8B8S</b>	<b>94201</b>									.030
<b>330i xDrive</b>													
2018-17	L4 2.0L		<b>SILZKGR8B8S</b>	<b>94201</b>									.030
<b>330xi</b>													
2006	L6 3.0L		<b>ILZFR6D11</b>	<b>1208</b>	LFR6AHX-S	94122	LFR6AIX-11	6619	LFR6CGP	1483	LFR6C-11	7787	.044
2005-01	L6 3.0L		<b>BKR6EQUP</b>	<b>3199</b>	FR6AHX-S	94279	BKR6EIX	6418	BKR6EGP	7092	BKR6E	6962	.032
<b>335i</b>													
2015-11	L6 3.0L		<b>SILZKBR8D8S</b>	<b>97506</b>									.032
<b>335i GT xDrive</b>													
2016-14	L6 3.0L		<b>SILZKBR8D8S</b>	<b>97506</b>									.032
<b>335i xDrive</b>													
2015-11	L6 3.0L		<b>SILZKBR8D8S</b>	<b>97506</b>									.032
<b>340i</b>													
2017-16	L6 3.0L		<b>SILZKGR8B8S</b>	<b>94201</b>									.030
<b>340i GT xDrive</b>													
2017	L6 3.0L		<b>SILZKGR8B8S</b>	<b>94201</b>									.030
<b>340i xDrive</b>													
2017-16	L6 3.0L		<b>SILZKGR8B8S</b>	<b>94201</b>									.030





Year	Cyl. L	Notes	Original Equipment		Ruthenium HX		Iridium IX		G-Power		V-Power		Gap
			Part	Stock	Part	Stock	Part	Stock	Part	Stock	Part	Stock	
<b>BMW (Cont'd)</b>													
428i													
2016-14	L4 2.0L		<b>SILZKBR8D8S</b>	<b>97506</b>									.032
428i Gran Coupe													
2016-15	L4 2.0L		<b>SILZKBR8D8S</b>	<b>97506</b>									.032
428i xDrive													
2016-14	L4 2.0L		<b>SILZKBR8D8S</b>	<b>97506</b>									.032
428i xDrive Gran Coupe													
2016-15	L4 2.0L		<b>SILZKBR8D8S</b>	<b>97506</b>									.032
430i													
2018-17	L4 2.0L		<b>SILZKGR8B8S</b>	<b>94201</b>									.030
430i Gran Coupe													
2018-17	L4 2.0L		<b>SILZKGR8B8S</b>	<b>94201</b>									.030
430i xDrive													
2018-17	L4 2.0L		<b>SILZKGR8B8S</b>	<b>94201</b>									.030
430i xDrive Gran Coupe													
2018-17	L4 2.0L		<b>SILZKGR8B8S</b>	<b>94201</b>									.030
435i													
2016-14	L6 3.0L		SILZKBR8D8S	97506									.032
435i Gran Coupe													
2016-15	L6 3.0L		SILZKBR8D8S	97506									.032
435i xDrive													
2016-14	L6 3.0L		SILZKBR8D8S	97506									.032
435i xDrive Gran Coupe													
2016-15	L6 3.0L		SILZKBR8D8S	97506									.032
440i													
2017	L6 3.0L		<b>SILZKGR8B8S</b>	<b>94201</b>									.030
440i Gran Coupe													
2017	L6 3.0L		<b>SILZKGR8B8S</b>	<b>94201</b>									.030
440i xDrive													
2017	L6 3.0L		<b>SILZKGR8B8S</b>	<b>94201</b>									.030
440i xDrive Gran Coupe													
2017	L6 3.0L		<b>SILZKGR8B8S</b>	<b>94201</b>									.030
524td													
1986-85	L6 2.4L	DIESEL	Y-918J	3704									
525i													
2007-06	L6 3.0L		<b>ILZFR6D11</b>	<b>1208</b>	LF6AHX-S	94122	LF6AIX-11	6619	LF6CGP	1483	LF6C-11	7787	.044
2005-01	L6 2.5L		<b>BKR6EQUP</b>	<b>3199</b>	FR6AHX-S	94279	BKR6EIX	6418	BKR6EGP	7092	BKR6E	6962	.032
1995-91	L6 2.5L		<b>BKR6EK</b>	<b>2288</b>			BKR6EIX	6418	BKR6EGP	7092	BKR6E	6962	.032
1990-89	L6 2.5L		ZGR5A	5077							ZGR5A	5077	.028
525iT													
1993	L6 2.5L		<b>BKR6EK</b>	<b>2288</b>			BKR6EIX	6418	BKR6EGP	7092	BKR6E	6962	.032
525xi													
2007-06	L6 3.0L		<b>ILZFR6D11</b>	<b>1208</b>	LF6AHX-S	94122	LF6AIX-11	6619	LF6CGP	1483	LF6C-11	7787	.044
528e													
1988-85	L6 2.7L		ZGR5A	5077							ZGR5A	5077	.028
528i													
2016-13	L4 2.0L		<b>SILZKBR8D8S</b>	<b>97506</b>									.032
2012	L4 2.0L	From 2/2012	<b>SILZKBR8D8S</b>	<b>97506</b>									.032
		To 2/2012	<b>SILZKBR8D8S</b>	<b>97506</b>									.032
2011	L6 3.0L		<b>LZFR6AP11GS</b>	<b>95712</b>	LF6AHX-S	94122							.044
2010-08	L6 3.0L		<b>PLZFR6A-11S</b>	<b>5987</b>	LF6AHX-S	94122	LF6AIX-11	6619	LF6CGP	1483	LF6C-11	7787	.044
2000-97	L6 2.8L		<b>BKR6EQUP</b>	<b>3199</b>	FR6AHX-S	94279	BKR6EIX	6418	BKR6EGP	7092	BKR6E	6962	.032
528i xDrive													
2016-13	L4 2.0L		<b>SILZKBR8D8S</b>	<b>97506</b>									.032
2012	L4 2.0L	From 2/2012	<b>SILZKBR8D8S</b>	<b>97506</b>									.032
		To 2/2012	<b>SILZKBR8D8S</b>	<b>97506</b>									.032
2010-09	L6 3.0L		<b>PLZFR6A-11S</b>	<b>5987</b>	LF6AHX-S	94122	LF6AIX-11	6619	LF6CGP	1483	LF6C-11	7787	.044

**Bold denotes NGK OE Manufacturer and/or OE Service Part**  
NOT BOLD denotes OE Equivalent Part

**Le texte en gras désigne une pièce d'équipement originale du manufacturier NGK et/ou pièce d'équipement originale de service**  
Le texte non en gras désigne une pièce d'équipement originale équivalente

Note: Due to different operating or engine conditions, alternate heat range plugs may be required.

Note: En raison de différences au niveau du fonctionnement ou des conditions du moteur, d'autres types de bougies avec variation de chaleur peuvent être nécessaires



Year	Cyl. L	Notes	Original Equipment		Ruthenium HX		Iridium IX		G-Power		V-Power		Gap
			Part	Stock	Part	Stock	Part	Stock	Part	Stock	Part	Stock	
<b>BMW (Cont'd)</b>													
<b>528xi</b>													
2008	L6 3.0L		<b>PLZFR6A-11S</b>	<b>5987</b>	LFR6AHX-S	94122	LFR6AIX-11	6619	LFR6CGP	1483	LFR6C-11	7787	.044
<b>530e</b>													
2018	L4 2.0L		<b>SILZKGR8B8S</b>	<b>94201</b>									.030
<b>530e xDrive</b>													
2018	L4 2.0L		<b>SILZKGR8B8S</b>	<b>94201</b>									.030
<b>530i</b>													
2018-17	L4 2.0L		<b>SILZKGR8B8S</b>	<b>94201</b>									.030
2007-06	L6 3.0L		<b>ILZFR6D11</b>	<b>1208</b>	LFR6AHX-S	94122	LFR6AIX-11	6619	LFR6CGP	1483	LFR6C-11	7787	.044
2005-01	L6 3.0L		<b>BKR6EQUP</b>	<b>3199</b>	FR6AHX-S	94279	BKR6EIX	6418	BKR6EGP	7092	BKR6E	6962	.032
1995-94	V8 3.0L		BKR6EK	2288			BKR6EIX	6418	BKR6EGP	7092	BKR6E	6962	.032
<b>530i xDrive</b>													
2018-17	L4 2.0L		<b>SILZKGR8B8S</b>	<b>94201</b>									.030
<b>530xi</b>													
2007-06	L6 3.0L		<b>ILZFR6D11</b>	<b>1208</b>	LFR6AHX-S	94122	LFR6AIX-11	6619	LFR6CGP	1483	LFR6C-11	7787	.044
<b>535i</b>													
2016-11	L6 3.0L		SILZKBR8D8S	97506									.032
1993-89	L6 3.5L		ZGR5A	5077						ZGR5A	5077		.028
1988-85	L6 3.5L		BPR5ES	7734			BPR5EIX	6597	BPR5EGP	7082	BPR5EY	1233	.028
<b>535i GT</b>													
2017-10	L6 3.0L		SILZKBR8D8S	97506									.032
<b>535i GT xDrive</b>													
2017-11	L6 3.0L		SILZKBR8D8S	97506									.032
<b>535is</b>													
1988	L6 3.5L		BPR5ES	7734			BPR5EIX	6597	BPR5EGP	7082	BPR5EY	1233	.028
<b>535i xDrive</b>													
2016-11	L6 3.0L		SILZKBR8D8S	97506									.032
<b>540i</b>													
2017	L6 3.0L		<b>SILZKGR8B8S</b>	<b>94201</b>									.030
2003-98	V8 4.4L		<b>BKR6EQUP</b>	<b>3199</b>	FR6AHX-S	94279	BKR6EIX	6418	BKR6EGP	7092	BKR6E	6962	.032
1997	V8 4.4L		<b>BKR6EK</b>	<b>2288</b>	FR6BHX-S	95159	BKR6EIX	6418	BKR6EGP	7092	BKR6E	6962	.032
1995-94	V8 4.0L		BKR6EK	2288			BKR6EIX	6418	BKR6EGP	7092	BKR6E	6962	.032
<b>540i xDrive</b>													
2017	L6 3.0L		<b>SILZKGR8B8S</b>	<b>94201</b>									.030
<b>545i</b>													
2005-04	V8 4.4L		<b>BKR6EQUP</b>	<b>3199</b>	FR6AHX-S	94279	BKR6EIX	6418	BKR6EGP	7092	BKR6E	6962	.032
<b>550i</b>													
2016-14	V8 4.4L		SILZKBR8D8S	97506									.032
2010-06	V8 4.8L		<b>IZFR6H11</b>	<b>4294</b>	FR6AHX-S	94279	ZFR6FIX-11	6441	ZFR6FGP	7100	ZFR6F-11	4291	.044
<b>550i GT</b>													
2015-14	V8 4.4L		SILZKBR8D8S	97506									.032
2013	V8 4.4L	Eng Desg N63B44B	SILZKBR8D8S	97506									.032
<b>550i GT xDrive</b>													
2017-14	V8 4.4L		SILZKBR8D8S	97506									.032
2013	V8 4.4L	Eng Desg N63B44B	SILZKBR8D8S	97506									.032
<b>550i xDrive</b>													
2016-14	V8 4.4L		SILZKBR8D8S	97506									.032
2013	V8 4.4L	Eng Desg N63B44B	SILZKBR8D8S	97506									.032
<b>635CSI</b>													
1989-88	L6 3.5L		ZGR5A	5077							ZGR5A	5077	.028
1987-85	L6 3.5L		BPR5ES	7734			BPR5EIX	6597	BPR5EGP	7082	BPR5EY	1233	.028
<b>640i</b>													
2017-12	L6 3.0L		SILZKBR8D8S	97506									.032
<b>640i Gran Coupe</b>													
2017-13	L6 3.0L		SILZKBR8D8S	97506									.032
<b>640i xDrive</b>													
2017-14	L6 3.0L		SILZKBR8D8S	97506									.032



Year	Cyl. L	Notes	Original Equipment		Ruthenium HX		Iridium IX		G-Power		V-Power		Gap
			Part	Stock	Part	Stock	Part	Stock	Part	Stock	Part	Stock	
<b>BMW (Cont'd)</b>													
<b>640i xDrive Gran Coupe</b>													
2017-14	L6 3.0L		SILZKBR8D8S	97506									.032
<b>645Ci</b>													
2005-04	V8 4.4L		<b>BKR6EQUP</b>	<b>3199</b>	FR6AHX-S	94279	BKR6EIX	6418	BKR6EGP	7092	BKR6E	6962	.032
<b>650i</b>													
2018-13	V8 4.4L		SILZKBR8D8S	97506									.032
2010-06	V8 4.8L		<b>IZFR6H11</b>	<b>4294</b>	FR6AHX-S	94279	ZFR6FIX-11	6441	ZFR6FGP	7100	ZFR6F-11	4291	.044
<b>650i Gran Coupe</b>													
2018-13	V8 4.4L		SILZKBR8D8S	97506									.032
<b>650i xDrive</b>													
2018-13	V8 4.4L		SILZKBR8D8S	97506									.032
<b>650i xDrive Gran Coupe</b>													
2018-13	V8 4.4L		SILZKBR8D8S	97506									.032
<b>735i</b>													
1992-88	L6 3.5L		ZGR5A	5077							ZGR5A	5077	.028
1987-85	L6 3.5L		BPR5ES	7734			BPR5EIX	6597	BPR5EGP	7082	BPR5EY	1233	.028
<b>735iL</b>													
1992-88	L6 3.5L		ZGR5A	5077							ZGR5A	5077	.028
<b>740e xDrive</b>													
2017	L4 2.0L		<b>SILZKGR8B8S</b>	<b>94201</b>									.030
<b>740i</b>													
2017-16	L6 3.0L		<b>SILZKGR8B8S</b>	<b>94201</b>									.030
2015	L6 3.0L	GAS	SILZKBR8D8S	97506									.032
2014-13	L6 3.0L		SILZKBR8D8S	97506									.032
2001-98	V8 4.4L		<b>BKR6EQUP</b>	<b>3199</b>	FR6AHX-S	94279	BKR6EIX	6418	BKR6EGP	7092	BKR6E	6962	.032
1997	V8 4.4L		<b>BKR6EK</b>	<b>2288</b>	FR6BHX-S	95159	BKR6EIX	6418	BKR6EGP	7092	BKR6E	6962	.032
1995-93	V8 4.0L		BKR6EK	2288			BKR6EIX	6418	BKR6EGP	7092	BKR6E	6962	.032
<b>740iL</b>													
2001-98	V8 4.4L		<b>BKR6EQUP</b>	<b>3199</b>	FR6AHX-S	94279	BKR6EIX	6418	BKR6EGP	7092	BKR6E	6962	.032
1997	V8 4.4L		<b>BKR6EK</b>	<b>2288</b>	FR6BHX-S	95159	BKR6EIX	6418	BKR6EGP	7092	BKR6E	6962	.032
1996	V8 4.4L		<b>BKR6EK</b>	<b>2288</b>			BKR6EIX	6418	BKR6EGP	7092	BKR6E	6962	.032
1995-93	V8 4.0L		BKR6EK	2288			BKR6EIX	6418	BKR6EGP	7092	BKR6E	6962	.032
<b>740i xDrive</b>													
2017	L6 3.0L		<b>SILZKGR8B8S</b>	<b>94201</b>									.030
<b>740Li</b>													
2015	L6 3.0L	GAS	SILZKBR8D8S	97506									.032
2014-13	L6 3.0L		SILZKBR8D8S	97506									.032
<b>740Li xDrive</b>													
2015	L6 3.0L	GAS	SILZKBR8D8S	97506									.032
2014-13	L6 3.0L		SILZKBR8D8S	97506									.032
<b>745i</b>													
2005-02	V8 4.4L		<b>BKR6EQUP</b>	<b>3199</b>	FR6AHX-S	94279	BKR6EIX	6418	BKR6EGP	7092	BKR6E	6962	.032
<b>745Li</b>													
2005-02	V8 4.4L		<b>BKR6EQUP</b>	<b>3199</b>	FR6AHX-S	94279	BKR6EIX	6418	BKR6EGP	7092	BKR6E	6962	.032
<b>750i</b>													
2018-13	V8 4.4L		SILZKBR8D8S	97506									.032
2008-06	V8 4.8L		<b>IZFR6H11</b>	<b>4294</b>	FR6AHX-S	94279	ZFR6FIX-11	6441	ZFR6FGP	7100	ZFR6F-11	4291	.044
<b>750iL</b>													
2001-99	V12 5.4L		<b>BKR6EQUP</b>	<b>3199</b>	FR6AHX-S	94279	BKR6EIX	6418	BKR6EGP	7092	BKR6E	6962	.032
1998	V12 5.4L	Eng Desg M73	ZFR4F-11	4043							ZFR4F-11	4043	.032
		Eng Desg M73N	BKR6EQUP	3199	FR6AHX-S	94279	BKR6EIX	6418	BKR6EGP	7092	BKR6E	6962	.032
1997	V12 5.4L		ZFR4F-11	4043							ZFR4F-11	4043	.032
1996-95	V12 5.4L		ZFR5F	7558			ZFR5FIX-11	2477	ZFR5FGP	7098	ZFR5F	7558	.032
1994-88	V12 5.0L		ZFR5F	7558			ZFR5FIX-11	2477	ZFR5FGP	7098	ZFR5F	7558	.032
<b>750i xDrive</b>													
2018-13	V8 4.4L		SILZKBR8D8S	97506									.032
<b>750Li</b>													
2015-13	V8 4.4L		SILZKBR8D8S	97506									.032

**Bold denotes NGK OE Manufacturer and/or OE Service Part**  
NOT BOLD denotes OE Equivalent Part

**Le texte en gras désigne une pièce d'équipement originale du manufacturier NGK et/ou pièce d'équipement originale de service**  
Le texte non en gras désigne une pièce d'équipement originale équivalente

Note: Due to different operating or engine conditions, alternate heat range plugs may be required.

Note: En raison de différences au niveau du fonctionnement ou des conditions du moteur, d'autres types de bougies avec variation de chaleur peuvent être nécessaires



Year	Cyl. L	Notes	Original Equipment		Ruthenium HX		Iridium IX		G-Power		V-Power		Gap
			Part	Stock	Part	Stock	Part	Stock	Part	Stock	Part	Stock	
<b>BMW (Cont'd)</b>													
<b>750Li (Cont'd)</b>													
2008-06	V8 4.8L		<b>IZFR6H11</b>	<b>4294</b>	FR6AHX-S	94279	ZFR6FIX-11	6441	ZFR6FGP	7100	ZFR6F-11	4291	.044
<b>750Li xDrive</b>													
2018-17	V8 4.4L		SILZKBR8D8S	97506									.032
2015-13	V8 4.4L		SILZKBR8D8S	97506									.032
<b>760i</b>													
2006-04	V12 6.0L		<b>BKR6EQUP</b>	<b>3199</b>	FR6AHX-S	94279	BKR6EIX	6418	BKR6EGP	7092	BKR6E	6962	.032
<b>760Li</b>													
2008-03	V12 6.0L		<b>BKR6EQUP</b>	<b>3199</b>	FR6AHX-S	94279	BKR6EIX	6418	BKR6EGP	7092	BKR6E	6962	.032
<b>840Ci</b>													
1997	V8 4.4L		<b>BKR6EK</b>	<b>2288</b>	FR6BHX-S	95159	BKR6EIX	6418	BKR6EGP	7092	BKR6E	6962	.032
1996	V8 4.4L		<b>BKR6EK</b>	<b>2288</b>			BKR6EIX	6418	BKR6EGP	7092	BKR6E	6962	.032
1995-94	V8 4.0L		BKR6EK	2288			BKR6EIX	6418	BKR6EGP	7092	BKR6E	6962	.032
<b>850Ci</b>													
1997	V12 5.4L		ZFR5F	7558	FR5AHX	95839	ZFR5FIX-11	2477	ZFR5FGP	7098	ZFR5F	7558	.032
1996-95	V12 5.4L		ZFR5F	7558			ZFR5FIX-11	2477	ZFR5FGP	7098	ZFR5F	7558	.032
1994-93	V12 5.0L		ZFR5F	7558			ZFR5FIX-11	2477	ZFR5FGP	7098	ZFR5F	7558	.032
<b>850CSi</b>													
1995-94	V12 5.6L		ZFR5F	7558			ZFR5FIX-11	2477	ZFR5FGP	7098	ZFR5F	7558	.032
<b>850i</b>													
1992-91	V12 5.0L		PZFR5F	3741			ZFR5FIX-11	2477	ZFR5FGP	7098	ZFR5F	7558	.032
<b>ActiveHybrid 3</b>													
2015-13	L6 3.0L		SILZKBR8D8S	97506									.032
<b>ActiveHybrid 5</b>													
2016-12	L6 3.0L		SILZKBR8D8S	97506									.032
<b>ActiveHybrid 7</b>													
2015	L6 3.0L	ELECTRIC/GAS	SILZKBR8D8S	97506									.032
2014-13	L6 3.0L		SILZKBR8D8S	97506									.032
<b>Alpina B6 Gran Coupe</b>													
2016	V8 4.4L		<b>SILZKBR8D8S</b>	<b>97506</b>									.032
<b>Alpina B6 xDrive Gran Coupe</b>													
2018-15	V8 4.4L		<b>SILZKBR8D8S</b>	<b>97506</b>									.032
<b>Alpina B7</b>													
2018-17	V8 4.4L		<b>SILZKBR8D8S</b>	<b>97506</b>									.032
2015-13	V8 4.4L		<b>SILZKBR8D8S</b>	<b>97506</b>									.032
2012-11	V8 4.4L		<b>SIZKBR8A8HS</b>	<b>1555</b>									.032
2008-07	V8 4.4L		<b>PFR7B</b>	<b>4853</b>	FR7BHX-S	92400	BKR7EIX	2667			BKR7E	4644	.025
<b>Alpina B7L</b>													
2015-13	V8 4.4L		<b>SILZKBR8D8S</b>	<b>97506</b>									.032
2012-11	V8 4.4L		<b>SIZKBR8A8HS</b>	<b>1555</b>									.032
<b>Alpina B7L xDrive</b>													
2015-13	V8 4.4L		<b>SILZKBR8D8S</b>	<b>97506</b>									.032
2012-11	V8 4.4L		<b>SIZKBR8A8HS</b>	<b>1555</b>									.032
<b>Alpina B7 xDrive</b>													
2015-13	V8 4.4L		<b>SILZKBR8D8S</b>	<b>97506</b>									.032
2012-11	V8 4.4L		<b>SIZKBR8A8HS</b>	<b>1555</b>									.032
<b>i8</b>													
2017-14	L3 1.5L		<b>SILZKGR8C8S</b>	<b>95248</b>									.032
<b>L6</b>													
1987	L6 3.5L		BPR5ES	7734			BPR5EIX	6597	BPR5EGP	7082	BPR5EY	1233	.028
<b>L7</b>													
1987-86	L6 3.5L		ZGR5A	5077							ZGR5A	5077	.028
<b>M2</b>													
2017-16	L6 3.0L		SILZKBR8D8S	97506									.032
<b>M3</b>													
2017-15	L6 3.0L		SILZKBR8D8S	97506									.032
2013-08	V8 4.0L		<b>LKR8AP</b>	<b>4471</b>	LKR8BHX-S	90465							.032
2006-01	L6 3.2L		<b>DCPR8EKP</b>	<b>7415</b>			DCPR8EIX	6546					.032



Year	Cyl. L	Notes	Original Equipment		Ruthenium HX		Iridium IX		G-Power		V-Power		Gap
			Part	Stock	Part	Stock	Part	Stock	Part	Stock	Part	Stock	
<b>BMW (Cont'd)</b>													
<b>M3 (Cont'd)</b>													
1999-97	L6 3.2L		<b>BKR6EQUP</b>	<b>3199</b>	FR6AHX-S	94279	BKR6EIX	6418	BKR6EGP	7092	BKR6E	6962	.032
1996	L6 3.2L		<b>BKR6EQUP</b>	<b>3199</b>			BKR6EIX	6418	BKR6EGP	7092	BKR6E	6962	.032
1995-94	L6 3.0L		BKR6EK	2288			BKR6EIX	6418	BKR6EGP	7092	BKR6E	6962	.032
1991-88	L4 2.3L		DR7EA	7839			DR7EIX	5686					.028
<b>M4</b>													
2017-15	L6 3.0L		SILZKBR8D8S	97506									.032
<b>M5</b>													
2016-12	V8 4.4L		SILZKBR8D8S	97506									.032
2010-06	V10 5.0L		<b>LKR8AP</b>	<b>4471</b>	LKR8BHX-S	90465							.032
2003	V8 5.0L		BKR6EQUP	3199	FR6AHX-S	94279	BKR6EIX	6418	BKR6EGP	7092	BKR6E	6962	.032
2002-00	V8 5.0L		<b>BKR6EQUP</b>	<b>3199</b>	FR6AHX-S	94279	BKR6EIX	6418	BKR6EGP	7092	BKR6E	6962	.032
1993-91	L6 3.6L		DCPR6E	3481			DCPR6EIX	8196					.024
1988	L6 3.5L		DR7EA	7839			DR7EIX	5686					.024
<b>M6</b>													
2018-12	V8 4.4L		SILZKBR8D8S	97506									.032
2010-06	V10 5.0L		<b>LKR8AP</b>	<b>4471</b>	LKR8BHX-S	90465							.032
1988-87	L6 3.5L		DR7EA	7839			DR7EIX	5686					.024
<b>M6 Gran Coupe</b>													
2018-14	V8 4.4L		SILZKBR8D8S	97506									.032
<b>M235i</b>													
2016-14	L6 3.0L		SILZKBR8D8S	97506									.032
<b>M235i xDrive</b>													
2016-15	L6 3.0L		SILZKBR8D8S	97506									.032
<b>M240i</b>													
2017	L6 3.0L		<b>SILZKGR8B8S</b>	<b>94201</b>									.030
<b>M240i xDrive</b>													
2017	L6 3.0L		<b>SILZKGR8B8S</b>	<b>94201</b>									.030
<b>M550i xDrive</b>													
2018	V8 4.4L		SILZKBR8D8S	97506									.032
<b>X1</b>													
2018-16	L4 2.0L		<b>SILZKGR8B8S</b>	<b>94201</b>									.030
2015-13	L4 2.0L		<b>SILZKBR8D8S</b>	<b>97506</b>									.032
	L6 3.0L		SILZKBR8D8S	97506									.032
2012	L4 2.0L		<b>SILZKBR8D8S</b>	<b>97506</b>									.032
<b>X3</b>													
2018	L4 2.0L		<b>SILZKGR8B8S</b>	<b>94201</b>									.030
2017-15	L4 2.0L	GAS	<b>SILZKBR8D8S</b>	<b>97506</b>									.032
	L6 3.0L		SILZKBR8D8S	97506									.032
2014-13	L4 2.0L		<b>SILZKBR8D8S</b>	<b>97506</b>									.032
	L6 3.0L		SILZKBR8D8S	97506									.032
2012-11	L6 3.0L	Naturally Aspirated	<b>LZFR6AP11GS</b>	<b>95712</b>	LFR6AHX-S	94122							.044
		Turbo	SILZKBR8D8S	97506									.032
2010	L6 3.0L		<b>LZFR6AP11GS</b>	<b>95712</b>	LFR6AHX-S	94122							.044
2009-08	L6 3.0L		<b>PLZFR6A-11S</b>	<b>5987</b>	LFR6AHX-S	94122	LFR6AIX-11	6619	LFR6CGP	1483	LFR6C-11	7787	.044
2007	L6 3.0L		<b>ILZFR6D11</b>	<b>1208</b>	LFR6AHX-S	94122	LFR6AIX-11	6619	LFR6CGP	1483	LFR6C-11	7787	.044
2006-04	L6 2.5L		<b>BKR6EQUP</b>	<b>3199</b>	FR6AHX-S	94279	BKR6EIX	6418	BKR6EGP	7092	BKR6E	6962	.032
	L6 3.0L		<b>BKR6EQUP</b>	<b>3199</b>	FR6AHX-S	94279	BKR6EIX	6418	BKR6EGP	7092	BKR6E	6962	.032
<b>X4</b>													
2018	L4 2.0L		<b>SILZKBR8D8S</b>	<b>97506</b>									.032
2017	L4 2.0L		<b>SILZKBR8D8S</b>	<b>97506</b>									.032
	L6 3.0L	M40i	SILZKBR8D8S	97506									.032
2016	L4 2.0L		<b>SILZKBR8D8S</b>	<b>97506</b>									.032
	L6 3.0L	M40i xDrive35i	SILZKBR8D8S	97506									.032
2015	L4 2.0L		<b>SILZKBR8D8S</b>	<b>97506</b>									.032
	L6 3.0L	xDrive35i	SILZKBR8D8S	97506									.032

**Bold denotes NGK OE Manufacturer and/or OE Service Part**  
NOT BOLD denotes OE Equivalent Part

**Le texte en gras désigne une pièce d'équipement originale du manufacturier NGK et/ou pièce d'équipement originale de service**  
Le texte non en gras désigne une pièce d'équipement originale équivalente

Note: Due to different operating or engine conditions, alternate heat range plugs may be required.

Note: En raison de différences au niveau du fonctionnement ou des conditions du moteur, d'autres types de bougies avec variation de chaleur peuvent être nécessaires





Year	Cyl. L	Notes	Original Equipment		Ruthenium HX		Iridium IX		G-Power		V-Power		Gap
			Part	Stock	Part	Stock	Part	Stock	Part	Stock	Part	Stock	
<b>BMW (Cont'd)</b>													
<b>X5</b>													
2018	V8 4.4L	Eng Desg N63B44B	SILZKBR8D8S	97506									.032
		Eng Desg S63R	SILZKBR8D8S	97506									.032
2017-16	L4 2.0L		<b>SILZKBR8D8S</b>	<b>97506</b>									.032
	L6 3.0L	GAS	SILZKBR8D8S	97506									.032
	V8 4.4L	Eng Desg N63B44B	SILZKBR8D8S	97506									.032
		Eng Desg S63R	SILZKBR8D8S	97506									.032
2015	L6 3.0L	GAS	SILZKBR8D8S	97506									.032
	V8 4.4L	Eng Desg N63B44B	SILZKBR8D8S	97506									.032
		Eng Desg S63R	SILZKBR8D8S	97506									.032
2014	L6 3.0L	GAS	SILZKBR8D8S	97506									.032
	V8 4.4L	Eng Desg N63B44B	SILZKBR8D8S	97506									.032
2013	L6 3.0L	GAS, Eng Desg N55B30A	SILZKBR8D8S	97506									.032
	V8 4.4L	Eng Desg N63B44B	SILZKBR8D8S	97506									.032
2012-11	L6 3.0L	GAS, Eng Desg N55B30A	SILZKBR8D8S	97506									.032
2010	L6 3.0L	GAS	<b>LZFR6AP11GS</b>	<b>95712</b>	LFR6AHX-S	94122							.044
	V8 4.8L		<b>IZFR6H11</b>	<b>4294</b>	FR6AHX-S	94279	ZFR6FIX-11	6441	ZFR6FGP	7100	ZFR6F-11	4291	.044
2009	L6 3.0L	GAS	<b>PLZFR6A-11S</b>	<b>5987</b>	LFR6AHX-S	94122	LFR6AIX-11	6619	LFR6CGP	1483	LFR6C-11	7787	.044
	V8 4.8L		<b>IZFR6H11</b>	<b>4294</b>	FR6AHX-S	94279	ZFR6FIX-11	6441	ZFR6FGP	7100	ZFR6F-11	4291	.044
2008	L6 3.0L		<b>PLZFR6A-11S</b>	<b>5987</b>	LFR6AHX-S	94122	LFR6AIX-11	6619	LFR6CGP	1483	LFR6C-11	7787	.044
	V8 4.8L		<b>IZFR6H11</b>	<b>4294</b>	FR6AHX-S	94279	ZFR6FIX-11	6441	ZFR6FGP	7100	ZFR6F-11	4291	.044
2007	L6 3.0L		<b>ILZFR6D11</b>	<b>1208</b>	LFR6AHX-S	94122	LFR6AIX-11	6619	LFR6CGP	1483	LFR6C-11	7787	.044
	V8 4.8L		<b>IZFR6H11</b>	<b>4294</b>	FR6AHX-S	94279	ZFR6FIX-11	6441	ZFR6FGP	7100	ZFR6F-11	4291	.044
2006-04	L6 3.0L		<b>BKR6EQUP</b>	<b>3199</b>	FR6AHX-S	94279	BKR6EIX	6418	BKR6EGP	7092	BKR6E	6962	.032
	V8 4.4L		<b>BKR6EQUP</b>	<b>3199</b>	FR6AHX-S	94279	BKR6EIX	6418	BKR6EGP	7092	BKR6E	6962	.032
	V8 4.8L		<b>IZFR6H11</b>	<b>4294</b>	FR6AHX-S	94279	ZFR6FIX-11	6441	ZFR6FGP	7100	ZFR6F-11	4291	.044
2003-02	L6 3.0L		<b>BKR6EQUP</b>	<b>3199</b>	FR6AHX-S	94279	BKR6EIX	6418	BKR6EGP	7092	BKR6E	6962	.032
	V8 4.4L		<b>BKR6EQUP</b>	<b>3199</b>	FR6AHX-S	94279	BKR6EIX	6418	BKR6EGP	7092	BKR6E	6962	.032
	V8 4.6L		<b>BKR6EQUP</b>	<b>3199</b>	FR6AHX-S	94279	BKR6EIX	6418	BKR6EGP	7092	BKR6E	6962	.032
2001	L6 3.0L		<b>BKR6EQUP</b>	<b>3199</b>	FR6AHX-S	94279	BKR6EIX	6418	BKR6EGP	7092	BKR6E	6962	.032
	V8 4.4L		<b>BKR6EQUP</b>	<b>3199</b>	FR6AHX-S	94279	BKR6EIX	6418	BKR6EGP	7092	BKR6E	6962	.032
2000	V8 4.4L		<b>BKR6EQUP</b>	<b>3199</b>	FR6AHX-S	94279	BKR6EIX	6418	BKR6EGP	7092	BKR6E	6962	.032
<b>X6</b>													
2018	V8 4.4L	Eng Desg N63B44B	SILZKBR8D8S	97506									.032
		Eng Desg S63R	SILZKBR8D8S	97506									.032
2017-15	L6 3.0L		SILZKBR8D8S	97506									.032
	V8 4.4L	Eng Desg N63B44B	SILZKBR8D8S	97506									.032
		Eng Desg S63R	SILZKBR8D8S	97506									.032
2014	L6 3.0L		SILZKBR8D8S	97506									.032
	V8 4.4L	N63B44B Eng.	SILZKBR8D8S	97506									.032
2013	L6 3.0L	Eng Desg N55B30A	SILZKBR8D8S	97506									.032
	V8 4.4L	Eng Desg N63B44B	SILZKBR8D8S	97506									.032
2012-11	L6 3.0L		SILZKBR8D8S	97506									.032
<b>Z3</b>													
2002-01	L6 2.5L		<b>BKR6EQUP</b>	<b>3199</b>	FR6AHX-S	94279	BKR6EIX	6418	BKR6EGP	7092	BKR6E	6962	.032
	L6 3.0L		<b>BKR6EQUP</b>	<b>3199</b>	FR6AHX-S	94279	BKR6EIX	6418	BKR6EGP	7092	BKR6E	6962	.032
	L6 3.2L		<b>DCPR8EKP</b>	<b>7415</b>			DCPR8EIX	6546					.032
2000-99	L6 2.5L		<b>BKR6EQUP</b>	<b>3199</b>	FR6AHX-S	94279	BKR6EIX	6418	BKR6EGP	7092	BKR6E	6962	.032
	L6 2.8L		<b>BKR6EQUP</b>	<b>3199</b>	FR6AHX-S	94279	BKR6EIX	6418	BKR6EGP	7092	BKR6E	6962	.032
	L6 3.2L		<b>BKR6EQUP</b>	<b>3199</b>	FR6AHX-S	94279	BKR6EIX	6418	BKR6EGP	7092	BKR6E	6962	.032
1998	L4 1.9L		<b>BKR6EK</b>	<b>2288</b>	FR6AHX-S	94279	BKR6EIX	6418	BKR6EGP	7092	BKR6E	6962	.032
	L6 2.8L		<b>BKR6EQUP</b>	<b>3199</b>	FR6AHX-S	94279	BKR6EIX	6418	BKR6EGP	7092	BKR6E	6962	.032
	L6 3.2L		<b>BKR6EQUP</b>	<b>3199</b>	FR6AHX-S	94279	BKR6EIX	6418	BKR6EGP	7092	BKR6E	6962	.032
1997	L4 1.9L		<b>BKR6EK</b>	<b>2288</b>	FR6AHX-S	94279	BKR6EIX	6418	BKR6EGP	7092	BKR6E	6962	.032
	L6 2.8L		<b>BKR6EQUP</b>	<b>3199</b>	FR6AHX-S	94279	BKR6EIX	6418	BKR6EGP	7092	BKR6E	6962	.032
1996	L4 1.9L		<b>BKR6EK</b>	<b>2288</b>			BKR6EIX	6418	BKR6EGP	7092	BKR6E	6962	.032



Year	Cyl. L	Notes	Original Equipment		Ruthenium HX		Iridium IX		G-Power		V-Power		Gap
			Part	Stock	Part	Stock	Part	Stock	Part	Stock	Part	Stock	
<b>BMW (Cont'd)</b>													
<b>Z4</b>													
2016-12	L4 2.0L		<b>SILZKBR8D8S</b>	<b>97506</b>									.032
2011-10	L6 3.0L	Naturally Aspirated	<b>LZFR6AP11GS</b>	<b>95712</b>	LF6AHX-S	94122							.044
2009	L6 3.0L	Naturally Aspirated	<b>PLZFR6A-11S</b>	<b>5987</b>	LF6AHX-S	94122	LF6AIX-11	6619	LF6CGP	1483	LF6C-11	7787	.044
2008	L6 3.0L		<b>PLZFR6A-11S</b>	<b>5987</b>	LF6AHX-S	94122	LF6AIX-11	6619	LF6CGP	1483	LF6C-11	7787	.044
	L6 3.2L		<b>DCPR8EKP</b>	<b>7415</b>			DCPR8EIX	6546					.032
2007-06	L6 3.0L		<b>ILZFR6D11</b>	<b>1208</b>	LF6AHX-S	94122	LF6AIX-11	6619	LF6CGP	1483	LF6C-11	7787	.044
	L6 3.2L		<b>DCPR8EKP</b>	<b>7415</b>			DCPR8EIX	6546					.032
2005-03	L6 2.5L		<b>BKR6EQUP</b>	<b>3199</b>	FR6AHX-S	94279	BKR6EIX	6418	BKR6EGP	7092	BKR6E	6962	.032
	L6 3.0L		<b>BKR6EQUP</b>	<b>3199</b>	FR6AHX-S	94279	BKR6EIX	6418	BKR6EGP	7092	BKR6E	6962	.032
<b>Z8</b>													
2003	V8 4.8L		<b>BKR6EQUP</b>	<b>3199</b>	FR6AHX-S	94279	BKR6EIX	6418	BKR6EGP	7092	BKR6E	6962	.032
	V8 5.0L		<b>BKR6EQUP</b>	<b>3199</b>	FR6AHX-S	94279	BKR6EIX	6418	BKR6EGP	7092	BKR6E	6962	.032
2002-00	V8 5.0L		<b>BKR6EQUP</b>	<b>3199</b>	FR6AHX-S	94279	BKR6EIX	6418	BKR6EGP	7092	BKR6E	6962	.032
<b>BUGATTI</b>													
<b>Veyron 16.4</b>													
2006	W16 8.0L		ILZKR7A	1961									.032
<b>BUICK</b>													
<b>Allure</b>													
2010	L4 2.4L		<b>ILTR5D</b>	<b>5476</b>	LTR5AHX	90220	LTR5IX-11	4344	LTR5GP	5019			.036
	V6 3.0L		<b>ILTR6E11</b>	<b>90117</b>	LTR6AHX	91276	LTR6IX-11	6509	LTR6GP	90198			.044
	V6 3.6L		<b>ILTR6E11</b>	<b>90117</b>	LTR6AHX	91276	LTR6IX-11	6509	LTR6GP	90198			.044
2009	V6 3.8L		<b>ITR4A15</b>	<b>5599</b>	TR4BHX	97100	TR55IX	7164	TR55GP	3403	TR55	3951	.060
	V8 5.3L		IZTR5B11	1465	TR5AHX	94567	TR5IX	7397	TR5GP	3186	TR5	2238	.040
2008	V6 3.6L		PLTR6A-10G	3587	LTR6AHX	91276	LTR6IX-11	6509	LTR6GP	90198			.044
	V6 3.8L		<b>ITR4A15</b>	<b>5599</b>	TR4BHX	97100	TR55IX	7164	TR55GP	3403	TR55	3951	.060
	V8 5.3L		IZTR5B11	1465	TR5AHX	94567	TR5IX	7397	TR5GP	3186	TR5	2238	.040
2007-06	V6 3.6L		PLTR6A-10G	3587	LTR6AHX	91276	LTR6IX-11	6509	LTR6GP	90198			.044
	V6 3.8L		<b>ITR4A15</b>	<b>5599</b>	TR4BHX	97100	TR55IX	7164	TR55GP	3403	TR55	3951	.060
2005	V6 3.6L		PLTR6A-10G	3587	LTR6AHX	91276	LTR6IX-11	6509	LTR6GP	90198			.044
	V6 3.8L		ITR4A15	5599	TR4BHX	97100	TR55IX	7164	TR55GP	3403	TR55	3951	.060
<b>Cascada</b>													
2017-16	L4 1.6L		<b>ILNAR8B7G</b>	<b>91970</b>									.028
<b>Century</b>													
2005-02	V6 3.1L		<b>ITR4A15</b>	<b>5599</b>	TR4BHX	97100	TR55IX	7164	TR55GP	3403	TR55	3951	.060
2001-97	V6 3.1L		ITR4A15	5599	TR4BHX	97100	TR55IX	7164	TR55GP	3403	TR55	3951	.060
1996-94	L4 2.2L		PZTR5A-15	7862			TR55-1IX	7316	TR55-1GP	7159	TR55-1	2683	.060
	V6 3.1L		ITR4A15	5599			TR55IX	7164	TR55GP	3403	TR55	3951	.060
1993	L4 2.2L		TR4	3754			TR4IX	7300	TR4GP	2815	TR4	3754	.045
	V6 3.3L		TR55	3951			TR55IX	7164	TR55GP	3403	TR55	3951	.060
1992-90	L4 2.5L		UR55	2248			UR55IX	7272			UR55	2248	.060
	V6 3.3L		TR55	3951			TR55IX	7164	TR55GP	3403	TR55	3951	.060
1989	L4 2.5L		UR55	2248			UR55IX	7272			UR55	2248	.060
	V6 2.8L		TR4	3754			TR4IX	7300	TR4GP	2815	TR4	3754	.045
	V6 3.3L		TR55	3951			TR55IX	7164	TR55GP	3403	TR55	3951	.060
1988-87	L4 2.5L		UR55	2248			UR55IX	7272			UR55	2248	.060
	V6 2.8L		TR4	3754			TR4IX	7300	TR4GP	2815	TR4	3754	.045
	V6 3.8L		TR5	2238			TR5IX	7397	TR5GP	3186	TR5	2238	.045
1986	L4 2.5L		UR55	2248			UR55IX	7272			UR55	2248	.060
	V6 2.8L		UR5	2771			UR5IX	7177	UR5GP	3547	UR5	2771	.045
	V6 3.8L		TR5	2238			TR5IX	7397	TR5GP	3186	TR5	2238	.045
1985	L4 2.5L		UR55	2248			UR55IX	7272			UR55	2248	.060
	V6 2.8L		UR5	2771			UR5IX	7177	UR5GP	3547	UR5	2771	.045
	V6 3.0L		UR45	6945			UR45IX	7559	UR45GP	3207	UR45	6945	.060
	V6 3.8L		UR45	6945			UR45IX	7559	UR45GP	3207	UR45	6945	.080
<b>Commercial Chassis</b>													
1996-94	V8 5.7L		PZTR5A-15	7862			TR55IX	7164	TR55GP	3403	TR55	3951	.050

**Bold denotes NGK OE Manufacturer and/or OE Service Part**  
NOT BOLD denotes OE Equivalent Part

**Le texte en gras désigne une pièce d'équipement originale du manufacturier NGK et/ou pièce d'équipement originale de service**  
Le texte non en gras désigne une pièce d'équipement originale équivalente

Note: Due to different operating or engine conditions, alternate heat range plugs may be required.

Note: En raison de différences au niveau du fonctionnement ou des conditions du moteur, d'autres types de bougies avec variation de chaleur peuvent être nécessaires



Year	Cyl. L	Notes	Original Equipment		Ruthenium HX		Iridium IX		G-Power		V-Power		Gap
			Part	Stock	Part	Stock	Part	Stock	Part	Stock	Part	Stock	
<b>BUICK (Cont'd)</b>													
Commercial Chassis (Cont'd)													
1993-92	V8 5.7L		UR5	2771			UR5IX	7177	UR5GP	3547	UR5	2771	.035
1991	V8 5.0L		UR4	6630			UR4IX	7401	UR4GP	2869	UR4	6630	.045
Electra													
1990	V6 3.8L		TR55	3951			TR55IX	7164	TR55GP	3403	TR55	3951	.060
1989-88	V6 3.8L		TR55	3951			TR55IX	7164	TR55GP	3403	TR55	3951	.060
	V8 5.0L		FR45	3686					FR45GP	3072	FR45	3686	.060
1987-86	V6 3.8L		TR5	2238			TR5IX	7397	TR5GP	3186	TR5	2238	.045
	V8 5.0L		FR45	3686					FR45GP	3072	FR45	3686	.060
1985	V6 3.0L		UR45	6945			UR45IX	7559	UR45GP	3207	UR45	6945	.060
	V6 3.8L		UR45	6945			UR45IX	7559	UR45GP	3207	UR45	6945	.080
	V8 5.0L		FR45	3686					FR45GP	3072	FR45	3686	.060
Enclave													
2018-08	V6 3.6L		<b>ILTR6E11</b>	<b>90117</b>	LTR6AHX	91276	LTR6IX-11	6509	LTR6GP	90198			.044
Encore													
2018-16	L4 1.4L	Eng Desg LE2	ILNAR8B7G	91970									.028
		Eng Desg LUV	<b>IFR7X7G</b>	<b>91039</b>	FR7BHX-S	92400							.027
2015-13	L4 1.4L		<b>IFR7X7G</b>	<b>91039</b>	FR7BHX-S	92400							.027
Envision													
2018-17	L4 2.0L		<b>ILTR6M9G</b>	<b>94489</b>	LTR6BHX	90495							.036
	L4 2.5L		<b>ILTR5L11</b>	<b>96329</b>	LTR5AHX	90220	LTR5IX-11	4344	LTR5GP	5019			.044
2016	L4 2.0L		<b>ILTR6M9G</b>	<b>94489</b>	LTR6BHX	90495							.036
LaCrosse													
2018	L4 2.5L		<b>ILTR5L11</b>	<b>96329</b>	LTR5AHX	90220	LTR5IX-11	4344	LTR5GP	5019			.044
2016-11	L4 2.4L		<b>ILTR5D</b>	<b>5476</b>	LTR5AHX	90220	LTR5IX-11	4344	LTR5GP	5019			.036
	V6 3.6L		<b>ILTR6E11</b>	<b>90117</b>	LTR6AHX	91276	LTR6IX-11	6509	LTR6GP	90198			.044
2010	L4 2.4L		<b>ILTR5D</b>	<b>5476</b>	LTR5AHX	90220	LTR5IX-11	4344	LTR5GP	5019			.036
	V6 3.0L		<b>ILTR6E11</b>	<b>90117</b>	LTR6AHX	91276	LTR6IX-11	6509	LTR6GP	90198			.044
	V6 3.6L		<b>ILTR6E11</b>	<b>90117</b>	LTR6AHX	91276	LTR6IX-11	6509	LTR6GP	90198			.044
2009	V6 3.8L		<b>ITR4A15</b>	<b>5599</b>	TR4BHX	97100	TR55IX	7164	TR55GP	3403	TR55	3951	.060
	V8 5.3L		IZTR5B11	1465	TR5AHX	94567	TR5IX	7397	TR5GP	3186	TR5	2238	.040
2008	V6 3.6L		PLTR6A-10G	3587	LTR6AHX	91276	LTR6IX-11	6509	LTR6GP	90198			.044
	V6 3.8L		<b>ITR4A15</b>	<b>5599</b>	TR4BHX	97100	TR55IX	7164	TR55GP	3403	TR55	3951	.060
	V8 5.3L		IZTR5B11	1465	TR5AHX	94567	TR5IX	7397	TR5GP	3186	TR5	2238	.040
2007-05	V6 3.6L		PLTR6A-10G	3587	LTR6AHX	91276	LTR6IX-11	6509	LTR6GP	90198			.044
	V6 3.8L		<b>ITR4A15</b>	<b>5599</b>	TR4BHX	97100	TR55IX	7164	TR55GP	3403	TR55	3951	.060
LeSabre													
2005-02	V6 3.8L		<b>ITR4A15</b>	<b>5599</b>	TR4BHX	97100	TR55IX	7164	TR55GP	3403	TR55	3951	.060
2001-97	V6 3.8L		ITR4A15	5599	TR4BHX	97100	TR55IX	7164	TR55GP	3403	TR55	3951	.060
1996-94	V6 3.8L		ITR4A15	5599			TR55IX	7164	TR55GP	3403	TR55	3951	.060
1993-91	V6 3.8L		TR55	3951			TR55IX	7164	TR55GP	3403	TR55	3951	.060
1990-89	V6 3.8L		TR55	3951			TR55IX	7164	TR55GP	3403	TR55	3951	.060
	V8 5.0L		FR45	3686					FR45GP	3072	FR45	3686	.060
1988	V6 3.8L	Vin 3	TR5	2238			TR5IX	7397	TR5GP	3186	TR5	2238	.045
		Vin C	TR55	3951			TR55IX	7164	TR55GP	3403	TR55	3951	.060
	V8 5.0L		FR45	3686					FR45GP	3072	FR45	3686	.060
1987	V6 3.8L		TR5	2238			TR5IX	7397	TR5GP	3186	TR5	2238	.045
	V8 5.0L	Estate Wagon	FR45	3686					FR45GP	3072	FR45	3686	.060
1986	V6 3.0L		TR5	2238			TR5IX	7397	TR5GP	3186	TR5	2238	.045
	V6 3.8L	Vin 3	TR5	2238			TR5IX	7397	TR5GP	3186	TR5	2238	.045
	V8 5.0L		FR45	3686					FR45GP	3072	FR45	3686	.060
1985	V6 3.8L		UR45	6945			UR45IX	7559	UR45GP	3207	UR45	6945	.060
	V8 5.0L		FR45	3686					FR45GP	3072	FR45	3686	.060
Lucerne													
2011-09	V6 3.9L		<b>IZTR4A11</b>	<b>4213</b>			TR4IX	7300	TR4GP	2815	TR4	3754	.044
	V8 4.6L		PTR5C-13	7740	TR5AHX	94567	TR55IX	7164	TR55GP	3403	TR55	3951	.052
2008-06	V6 3.8L		<b>ITR4A15</b>	<b>5599</b>	TR4BHX	97100	TR55IX	7164	TR55GP	3403	TR55	3951	.060
	V8 4.6L		PTR5C-13	7740	TR5AHX	94567	TR55IX	7164	TR55GP	3403	TR55	3951	.052



Year	Cyl. L	Notes	Original Equipment		Ruthenium HX		Iridium IX		G-Power		V-Power		Gap
			Part	Stock	Part	Stock	Part	Stock	Part	Stock	Part	Stock	
<b>BUICK (Cont'd)</b>													
Park Avenue													
2005-97	V6 3.8L		<b>ITR4A15</b>	<b>5599</b>	TR4BHX	97100	TR55IX	7164	TR55GP	3403	TR55	3951	.060
1996	V6 3.8L		<b>ITR4A15</b>	<b>5599</b>			TR55IX	7164	TR55GP	3403	TR55	3951	.060
1995-91	V6 3.8L		ITR4A15	5599			TR55IX	7164	TR55GP	3403	TR55	3951	.060
Rainier													
2007-04	L6 4.2L		<b>ILTR5E11</b>	<b>91418</b>	LTR5AHX	90220	LTR5IX-11	4344	LTR5GP	5019			.044
	V8 5.3L		IZTR5B11	1465	TR5AHX	94567	TR5IX	7397	TR5GP	3186	TR5	2238	.040
Reatta													
1991-88	V6 3.8L		TR55	3951			TR55IX	7164	TR55GP	3403	TR55	3951	.060
Regal													
2017-14	L4 2.0L		<b>ILTR6M9G</b>	<b>94489</b>	LTR6BHX	90495							.036
	L4 2.4L		<b>ILTR5D</b>	<b>5476</b>	LTR5AHX	90220	LTR5IX-11	4344	LTR5GP	5019			.036
2013-11	L4 2.0L		<b>ILTR5D</b>	<b>5476</b>			LTR5IX-11	4344	LTR5GP	5019			.036
	L4 2.4L		<b>ILTR5D</b>	<b>5476</b>	LTR5AHX	90220	LTR5IX-11	4344	LTR5GP	5019			.036
2004-02	V6 3.8L		<b>ITR4A15</b>	<b>5599</b>	TR4BHX	97100	TR55IX	7164	TR55GP	3403	TR55	3951	.060
2001-97	V6 3.8L	Naturally Aspirated	ITR4A15	5599	TR4BHX	97100	TR55IX	7164	TR55GP	3403	TR55	3951	.060
		Supercharged	<b>ITR4A15</b>	<b>5599</b>	TR4BHX	97100	TR55IX	7164	TR55GP	3403	TR55	3951	.060
1996-94	V6 3.1L		ITR4A15	5599			TR55IX	7164	TR55GP	3403	TR55	3951	.060
	V6 3.8L		ITR4A15	5599			TR55IX	7164	TR55GP	3403	TR55	3951	.060
1993-90	V6 3.1L		TR4	3754			TR4IX	7300	TR4GP	2815	TR4	3754	.045
	V6 3.8L		TR55	3951			TR55IX	7164	TR55GP	3403	TR55	3951	.060
1989	V6 2.8L		TR4	3754			TR4IX	7300	TR4GP	2815	TR4	3754	.045
	V6 3.1L		TR4	3754			TR4IX	7300	TR4GP	2815	TR4	3754	.045
1988	V6 2.8L		TR4	3754			TR4IX	7300	TR4GP	2815	TR4	3754	.045
1987-86	V6 3.8L	Naturally Aspirated	UR45	6945			UR45IX	7559	UR45GP	3207	UR45	6945	.060
		Turbo	UR4	6630			UR4IX	7401	UR4GP	2869	UR4	6630	.035
	V8 5.0L	Vin H	UR4	6630			UR4IX	7401	UR4GP	2869	UR4	6630	.045
		Vin Y	FR45	3686					FR45GP	3072	FR45	3686	.060
1985	V6 3.8L	Naturally Aspirated	UR45	6945			UR45IX	7559	UR45GP	3207	UR45	6945	.060
		Turbo	UR4	6630			UR4IX	7401	UR4GP	2869	UR4	6630	.045
	V8 5.0L		UR4	6630			UR4IX	7401	UR4GP	2869	UR4	6630	.045
Rendezvous													
2007	V6 3.5L		<b>ITR4A15</b>	<b>5599</b>	TR4BHX	97100	TR55IX	7164	TR55GP	3403	TR55	3951	.060
2006	V6 3.5L		<b>ITR4A15</b>	<b>5599</b>	TR4BHX	97100	TR55IX	7164	TR55GP	3403	TR55	3951	.060
	V6 3.6L		<b>PLTR6A-10G</b>	<b>3587</b>	LTR6AHX	91276	LTR6IX-11	6509	LTR6GP	90198			.040
2005-04	V6 3.4L		<b>ITR4A15</b>	<b>5599</b>	TR4BHX	97100	TR55IX	7164	TR55GP	3403	TR55	3951	.060
	V6 3.6L		PLTR6A-10G	3587	LTR6AHX	91276	LTR6IX-11	6509	LTR6GP	90198			.040
2003-02	V6 3.4L		<b>ITR4A15</b>	<b>5599</b>	TR4BHX	97100	TR55IX	7164	TR55GP	3403	TR55	3951	.060
Riviera													
1999-98	V6 3.8L		<b>ITR4A15</b>	<b>5599</b>	TR4BHX	97100	TR55IX	7164	TR55GP	3403	TR55	3951	.060
1997	V6 3.8L		ITR4A15	5599	TR4BHX	97100	TR55IX	7164	TR55GP	3403	TR55	3951	.060
1996-95	V6 3.8L		ITR4A15	5599			TR55IX	7164	TR55GP	3403	TR55	3951	.060
1993-88	V6 3.8L		TR55	3951			TR55IX	7164	TR55GP	3403	TR55	3951	.060
1987-86	V6 3.8L		TR5	2238			TR5IX	7397	TR5GP	3186	TR5	2238	.045
1985	V6 3.8L		UR4	6630			UR4IX	7401	UR4GP	2869	UR4	6630	.045
	V8 5.0L		FR45	3686					FR45GP	3072	FR45	3686	.060
Roadmaster													
1996-94	V8 5.7L		PTR5F-11	6579			TR55IX	7164	TR55GP	3403	TR55	3951	.050
1993-92	V8 5.7L		UR5	2771			UR5IX	7177	UR5GP	3547	UR5	2771	.035
1991	V8 5.0L		UR4	6630			UR4IX	7401	UR4GP	2869	UR4	6630	.045
Skyhawk													
1989	L4 2.0L		TR4	3754			TR4IX	7300	TR4GP	2815	TR4	3754	.035
1988	L4 2.0L	Vin 1	TR4	3754			TR4IX	7300	TR4GP	2815	TR4	3754	.035
		Vin K	GR45	4268					GR45GP	3142	GR45	4268	.060
1987	L4 2.0L	Vin 1	TR4	3754			TR4IX	7300	TR4GP	2815	TR4	3754	.035
		Vin K	GR45	4268					GR45GP	3142	GR45	4268	.060
		Vin M	GR5	2851			GR5IX	7214	GR5GP	3351	GR5	2851	.035
1986	L4 1.8L		GR5	2851			GR5IX	7214	GR5GP	3351	GR5	2851	.035

**Bold denotes NGK OE Manufacturer and/or OE Service Part**  
 NOT BOLD denotes OE Equivalent Part

Note: Due to different operating or engine conditions, alternate heat range plugs may be required.

**Le texte en gras désigne une pièce d'équipement originale du manufacturier NGK et/ou pièce d'équipement originale de service**  
 Le texte non en gras désigne une pièce d'équipement originale équivalente

Note: En raison de différences au niveau du fonctionnement ou des conditions du moteur, d'autres types de bougies avec variation de chaleur peuvent être nécessaires



Year	Cyl. L	Notes	Original Equipment		Ruthenium HX		Iridium IX		G-Power		V-Power		Gap
			Part	Stock	Part	Stock	Part	Stock	Part	Stock	Part	Stock	
<b>BUICK (Cont'd)</b>													
<b>Skyhawk (Cont'd)</b>													
1986	L4 2.0L		UR5	2771			UR5IX	7177	UR5GP	3547	UR5	2771	.035
1985	L4 1.8L	Turbo	GR5	2851			GR5IX	7214	GR5GP	3351	GR5	2851	.035
	L4 2.0L		UR5	2771			UR5IX	7177	UR5GP	3547	UR5	2771	.035
<b>Skylark</b>													
1998-97	L4 2.4L		PZTR5A-15	7862	TR5AHX	94567	TR55IX	7164	TR55GP	3403	TR55	3951	.060
	V6 3.1L		ITR4A15	5599	TR4BHX	97100	TR55IX	7164	TR55GP	3403	TR55	3951	.060
1996	L4 2.4L		PZTR5A-15	7862			TR55IX	7164	TR55GP	3403	TR55	3951	.060
	V6 3.1L		ITR4A15	5599			TR55IX	7164	TR55GP	3403	TR55	3951	.060
1995	L4 2.3L		PTR5F-11	6579			TR55IX	7164	TR55GP	3403	TR55	3951	.050
	V6 3.1L		ITR4A15	5599			TR55IX	7164	TR55GP	3403	TR55	3951	.060
1994	L4 2.3L		FR4	5155			BKR4EIX	5693	FR4GP	2685	FR4	5155	.035
	V6 3.1L		ITR4A15	5599			TR55IX	7164	TR55GP	3403	TR55	3951	.060
1993-92	L4 2.3L		FR4	5155			BKR4EIX	5693	FR4GP	2685	FR4	5155	.035
	V6 3.3L		TR55	3951			TR55IX	7164	TR55GP	3403	TR55	3951	.060
1991-89	L4 2.3L		FR4	5155			BKR4EIX	5693	FR4GP	2685	FR4	5155	.035
	L4 2.5L		UR55	2248			UR55IX	7272			UR55	2248	.060
	V6 3.3L		TR55	3951			TR55IX	7164	TR55GP	3403	TR55	3951	.060
1988	L4 2.3L		FR4	5155			BKR4EIX	5693	FR4GP	2685	FR4	5155	.035
	L4 2.5L		UR55	2248			UR55IX	7272			UR55	2248	.060
	V6 3.0L		TR5	2238			TR5IX	7397	TR5GP	3186	TR5	2238	.045
1987-86	L4 2.5L		UR55	2248			UR55IX	7272			UR55	2248	.060
	V6 3.0L		TR5	2238			TR5IX	7397	TR5GP	3186	TR5	2238	.045
1985	L4 2.5L		UR55	2248			UR55IX	7272			UR55	2248	.060
	V6 2.8L		UR5	2771			UR5IX	7177	UR5GP	3547	UR5	2771	.045
<b>Somerset</b>													
1987-86	L4 2.5L		UR55	2248			UR55IX	7272			UR55	2248	.060
	V6 3.0L		TR5	2238			TR5IX	7397	TR5GP	3186	TR5	2238	.045
<b>Somerset Regal</b>													
1985	L4 2.5L		UR55	2248			UR55IX	7272			UR55	2248	.060
	V6 3.0L		TR5	2238			TR5IX	7397	TR5GP	3186	TR5	2238	.045
<b>Terraza</b>													
2007	V6 3.9L		<b>IZTR4A11</b>	<b>4213</b>			TR4IX	7300	TR4GP	2815	TR4	3754	.044
2006	V6 3.5L		<b>ITR4A15</b>	<b>5599</b>	TR4BHX	97100	TR55IX	7164	TR55GP	3403	TR55	3951	.060
	V6 3.9L		<b>IZTR4A11</b>	<b>4213</b>			TR4IX	7300	TR4GP	2815	TR4	3754	.044
2005	V6 3.5L		<b>ITR4A15</b>	<b>5599</b>	TR4BHX	97100	TR55IX	7164	TR55GP	3403	TR55	3951	.060
<b>Verano</b>													
2017	L4 2.4L		<b>ILTR5D</b>	<b>5476</b>	LTR5AHX	90220	LTR5IX-11	4344	LTR5GP	5019			.036
2016-13	L4 2.0L		<b>ILTR5D</b>	<b>5476</b>			LTR5IX-11	4344	LTR5GP	5019			.036
	L4 2.4L		<b>ILTR5D</b>	<b>5476</b>	LTR5AHX	90220	LTR5IX-11	4344	LTR5GP	5019			.036
2012	L4 2.4L		<b>ILTR5D</b>	<b>5476</b>	LTR5AHX	90220	LTR5IX-11	4344	LTR5GP	5019			.036
<b>CADILLAC</b>													
<b>60 Special</b>													
1993	V8 4.9L		TR55	3951			TR55IX	7164	TR55GP	3403	TR55	3951	.060
<b>Allante</b>													
1993	V8 4.6L		TR55	3951			TR55IX	7164	TR55GP	3403	TR55	3951	.060
1992-89	V8 4.5L		TR55	3951			TR55IX	7164	TR55GP	3403	TR55	3951	.060
1988-87	V8 4.1L		TR55	3951			TR55IX	7164	TR55GP	3403	TR55	3951	.060
<b>ATS</b>													
2018	L4 2.0L		<b>ILTR6M9G</b>	<b>94489</b>	LTR6BHX	90495							.036
	V6 3.6L	Turbo			LTR7BHX	95605							.036
2017-16	L4 2.0L		<b>ILTR6M9G</b>	<b>94489</b>	LTR6BHX	90495							.036
	L4 2.5L		<b>ILTR5L11</b>	<b>96329</b>	LTR5AHX	90220	LTR5IX-11	4344	LTR5GP	5019			.044
	V6 3.6L	Turbo			LTR7BHX	95605							.036
2015-14	L4 2.0L		<b>ILTR6M9G</b>	<b>94489</b>	LTR6BHX	90495							.036
	L4 2.5L		<b>ILTR5L11</b>	<b>96329</b>	LTR5AHX	90220	LTR5IX-11	4344	LTR5GP	5019			.044
	V6 3.6L		<b>ILTR6E11</b>	<b>90117</b>	LTR6AHX	91276	LTR6IX-11	6509	LTR6GP	90198			.044
2013	L4 2.0L		<b>ILTR5M9G</b>	<b>90882</b>			LTR5IX-11	4344	LTR5GP	5019			.036





Year	Cyl. L	Notes	Original Equipment		Ruthenium HX		Iridium IX		G-Power		V-Power		Gap
			Part	Stock	Part	Stock	Part	Stock	Part	Stock	Part	Stock	
<b>CADILLAC (Cont'd)</b>													
<b>ATS (Cont'd)</b>													
2013	L4 2.5L		<b>ILTR5L11</b>	<b>96329</b>	LTR5AHX	90220	LTR5IX-11	4344	LTR5GP	5019			.044
	V6 3.6L		<b>ILTR6E11</b>	<b>90117</b>	LTR6AHX	91276	LTR6IX-11	6509	LTR6GP	90198			.044
<b>Brougham</b>													
1992-91	V8 5.0L		UR4	6630			UR4IX	7401	UR4GP	2869	UR4	6630	.045
	V8 5.7L		UR5	2771			UR5IX	7177	UR5GP	3547	UR5	2771	.035
1990	V8 5.0L		FR45	3686					FR45GP	3072	FR45	3686	.060
	V8 5.7L		UR5	2771			UR5IX	7177	UR5GP	3547	UR5	2771	.035
1989-87	V8 5.0L		FR45	3686					FR45GP	3072	FR45	3686	.060
<b>Catera</b>													
2001-99	V6 3.0L		BKR5E	7938	FR5AHX	95839	BKR5EIX	6341	BKR5EGP	7090	BKR5E	7938	.040
1998-97	V6 3.0L		BKR5E	7938	FR5BHX	96457	BKR5EIX	6341	BKR5EGP	7090	BKR5E	7938	.040
<b>Cimarron</b>													
1988-87	V6 2.8L		TR4	3754			TR4IX	7300	TR4GP	2815	TR4	3754	.045
1986-85	L4 2.0L		UR5	2771			UR5IX	7177	UR5GP	3547	UR5	2771	.035
	V6 2.8L		UR5	2771			UR5IX	7177	UR5GP	3547	UR5	2771	.045
<b>Commercial Chassis</b>													
1996-94	V8 5.7L		PZTR5A-15	7862			TR55IX	7164	TR55GP	3403	TR55	3951	.050
1993	V8 4.9L		TR55	3951			TR55IX	7164	TR55GP	3403	TR55	3951	.060
	V8 5.7L		UR4	6630			UR4IX	7401	UR4GP	2869	UR4	6630	.035
1992	V8 4.9L		TR55	3951			TR55IX	7164	TR55GP	3403	TR55	3951	.060
	V8 5.7L		UR5	2771			UR5IX	7177	UR5GP	3547	UR5	2771	.035
1991	V8 4.9L		TR55	3951			TR55IX	7164	TR55GP	3403	TR55	3951	.060
1990-88	V8 4.5L		TR55	3951			TR55IX	7164	TR55GP	3403	TR55	3951	.060
1987-85	V8 4.1L		TR55	3951			TR55IX	7164	TR55GP	3403	TR55	3951	.060
<b>CT6</b>													
2018	L4 2.0L		<b>ILTR6M9G</b>	<b>94489</b>	LTR6BHX	90495							.036
2017-16	L4 2.0L		<b>ILTR6M9G</b>	<b>94489</b>	LTR6BHX	90495							.036
	V6 3.0L		<b>ILTR7E9</b>	<b>90543</b>	LTR7BHX	95605	LTR7IX-11	6510					.036
<b>CTS</b>													
2019	V6 3.6L	Turbo			LTR7BHX	95605							.036
2018-17	L4 2.0L		<b>ILTR6M9G</b>	<b>94489</b>	LTR6BHX	90495							.036
	V6 3.6L	Turbo			LTR7BHX	95605							.036
	V8 6.2L		ILTR5D	5476			LTR5IX-11	4344	LTR5GP	5019			.032
2016	L4 2.0L		<b>ILTR6M9G</b>	<b>94489</b>	LTR6BHX	90495							.036
	V6 3.6L	Turbo			LTR7BHX	95605							.036
	V8 6.2L	Supercharged	ILTR5D	5476			LTR5IX-11	4344	LTR5GP	5019			.032
2015	L4 2.0L		<b>ILTR6M9G</b>	<b>94489</b>	LTR6BHX	90495							.036
	V6 3.6L	Naturally Aspirated	<b>ILTR6E11</b>	<b>90117</b>	LTR6AHX	91276	LTR6IX-11	6509	LTR6GP	90198			.044
		Turbo			LTR7BHX	95605							.036
2014	V8 6.2L						TR6IX	3689	TR6GP	5141	TR6	4177	.040
	L4 2.0L		<b>ILTR6M9G</b>	<b>94489</b>	LTR6BHX	90495							.036
	V6 3.0L		<b>ILTR6E11</b>	<b>90117</b>	LTR6AHX	91276	LTR6IX-11	6509	LTR6GP	90198			.044
	V6 3.6L	Naturally Aspirated	<b>ILTR6E11</b>	<b>90117</b>	LTR6AHX	91276	LTR6IX-11	6509	LTR6GP	90198			.044
2013-11	V8 6.2L		<b>ILTR7E9</b>	<b>90543</b>	LTR7BHX	95605	LTR7IX-11	6510					.036
	V6 3.0L		<b>ILTR6E11</b>	<b>90117</b>	LTR6AHX	91276	LTR6IX-11	6509	LTR6GP	90198			.044
	V6 3.6L		<b>ILTR6E11</b>	<b>90117</b>	LTR6AHX	91276	LTR6IX-11	6509	LTR6GP	90198			.044
2010	V8 6.2L						TR6IX	3689	TR6GP	5141	TR6	4177	.040
	V6 3.0L		<b>ILTR6E11</b>	<b>90117</b>	LTR6AHX	91276	LTR6IX-11	6509	LTR6GP	90198			.044
	V6 3.6L		<b>ILTR6E11</b>	<b>90117</b>	LTR6AHX	91276	LTR6IX-11	6509	LTR6GP	90198			.044
2009	V8 6.2L						TR6IX	3689	TR6GP	5141	TR6	4177	.040
	V6 3.0L		<b>ILTR6E11</b>	<b>90117</b>	LTR6AHX	91276	LTR6IX-11	6509	LTR6GP	90198			.044
	V6 3.6L		PLTR6A-10G	3587	LTR6AHX	91276	LTR6IX-11	6509	LTR6GP	90198			.044
2008	V8 6.2L						TR6IX	3689	TR6GP	5141	TR6	4177	.040
	V6 3.6L		PLTR6A-10G	3587	LTR6AHX	91276	LTR6IX-11	6509	LTR6GP	90198			.044
2007-06	V6 2.8L		PLTR6A-10G	3587	LTR6AHX	91276	LTR6IX-11	6509	LTR6GP	90198			.040
	V6 3.6L		PLTR6A-10G	3587	LTR6AHX	91276	LTR6IX-11	6509	LTR6GP	90198			.044
	V8 6.0L		IZTR5B11	1465	TR5AHX	94567	TR5IX	7397	TR5GP	3186	TR5	2238	.040

**Bold denotes NGK OE Manufacturer and/or OE Service Part**  
NOT BOLD denotes OE Equivalent Part

**Le texte en gras désigne une pièce d'équipement originale du manufacturier NGK et/ou pièce d'équipement originale de service**  
Le texte non en gras désigne une pièce d'équipement originale équivalente

Note: Due to different operating or engine conditions, alternate heat range plugs may be required.

Note: En raison de différences au niveau du fonctionnement ou des conditions du moteur, d'autres types de bougies avec variation de chaleur peuvent être nécessaires



Year	Cyl. L	Notes	Original Equipment		Ruthenium HX		Iridium IX		G-Power		V-Power		Gap
			Part	Stock	Part	Stock	Part	Stock	Part	Stock	Part	Stock	
<b>CADILLAC (Cont'd)</b>													
<b>CTS (Cont'd)</b>													
2005	V6 2.8L		PLTR6A-10G	3587	LTR6AHX	91276	LTR6IX-11	6509	LTR6GP	90198			.040
	V6 3.6L		PLTR6A-10G	3587	LTR6AHX	91276	LTR6IX-11	6509	LTR6GP	90198			.040
	V8 5.7L		IZTR5B11	1465	TR5AHX	94567	TR5IX	7397	TR5GP	3186	TR5	2238	.040
2004	V6 3.2L		<b>BKR6EQUP</b>	<b>3199</b>	FR6AHX-S	94279	BKR6EIX	6418	BKR6EGP	7092	BKR6E	6962	.032
	V6 3.6L		PLTR6A-10G	3587	LTR6AHX	91276	LTR6IX-11	6509	LTR6GP	90198			.040
	V8 5.7L		IZTR5B11	1465	TR5AHX	94567	TR5IX	7397	TR5GP	3186	TR5	2238	.040
2003	V6 3.2L		BKR6EKUB	7969	FR6AHX-S	94279	BKR6EIX	6418	BKR6EGP	7092	BKR6E	6962	.032
<b>DeVille</b>													
2005-00	V8 4.6L		PTR5F-11	6579	TR5AHX	94567	TR55IX	7164	TR55GP	3403	TR55	3951	.050
1999-96	V8 4.6L		PTR5F-11	6579			TR55IX	7164	TR55GP	3403	TR55	3951	.050
1995-94	V8 4.6L		PTR5F-11	6579			TR55IX	7164	TR55GP	3403	TR55	3951	.050
	V8 4.9L		PZTR5A-15	7862			TR55IX	7164	TR55GP	3403	TR55	3951	.060
1993-91	V8 4.9L		TR55	3951			TR55IX	7164	TR55GP	3403	TR55	3951	.060
1990-88	V8 4.5L		TR55	3951			TR55IX	7164	TR55GP	3403	TR55	3951	.060
1987-85	V8 4.1L		TR55	3951			TR55IX	7164	TR55GP	3403	TR55	3951	.060
<b>DTS</b>													
2011-06	V8 4.6L		PTR5C-13	7740	TR5AHX	94567	TR55IX	7164	TR55GP	3403	TR55	3951	.052
<b>Eldorado</b>													
2002-00	V8 4.6L		PTR5F-11	6579	TR5AHX	94567	TR55IX	7164	TR55GP	3403	TR55	3951	.050
1999-94	V8 4.6L		PTR5F-11	6579			TR55IX	7164	TR55GP	3403	TR55	3951	.050
1993	V8 4.6L		TR55	3951			TR55IX	7164	TR55GP	3403	TR55	3951	.050
	V8 4.9L		TR55	3951			TR55IX	7164	TR55GP	3403	TR55	3951	.060
1992-91	V8 4.9L		TR55	3951			TR55IX	7164	TR55GP	3403	TR55	3951	.060
1990-88	V8 4.5L		TR55	3951			TR55IX	7164	TR55GP	3403	TR55	3951	.060
1987-85	V8 4.1L		TR55	3951			TR55IX	7164	TR55GP	3403	TR55	3951	.060
<b>ELR</b>													
2016-14	L4 1.4L		<b>IFR6Z7G</b>	<b>95609</b>	FR6AHX-S	94279							.027
<b>Escalade</b>													
2018-15	V8 6.2L		ILTR5B11	3474	LTR5AHX	90220	LTR5IX-11	4344	LTR5GP	5019			.044
2014	V8 6.2L		IZTR5B11	1465	TR5AHX	94567	TR5IX	7397	TR5GP	3186	TR5	2238	.040
2013-09	V8 6.0L		IZTR5B11	1465	TR5AHX	94567	TR5IX	7397	TR5GP	3186	TR5	2238	.040
	V8 6.2L		IZTR5B11	1465	TR5AHX	94567	TR5IX	7397	TR5GP	3186	TR5	2238	.040
2008-07	V8 6.2L		IZTR5B11	1465	TR5AHX	94567	TR5IX	7397	TR5GP	3186	TR5	2238	.040
2006	V8 6.0L		IZTR5B11	1465	TR5AHX	94567	TR5IX	7397	TR5GP	3186	TR5	2238	.040
2005-02	V8 5.3L		IZTR5B11	1465	TR5AHX	94567	TR5IX	7397	TR5GP	3186	TR5	2238	.040
	V8 6.0L		IZTR5B11	1465	TR5AHX	94567	TR5IX	7397	TR5GP	3186	TR5	2238	.040
2000-99	V8 5.7L		<b>ITR4A15</b>	<b>5599</b>	TR5AHX	94567	TR55IX	7164	TR55GP	3403	TR55	3951	.060
<b>Escalade ESV</b>													
2018-15	V8 6.2L		ILTR5B11	3474	LTR5AHX	90220	LTR5IX-11	4344	LTR5GP	5019			.044
2014-07	V8 6.2L		IZTR5B11	1465	TR5AHX	94567	TR5IX	7397	TR5GP	3186	TR5	2238	.040
2006-03	V8 6.0L		IZTR5B11	1465	TR5AHX	94567	TR5IX	7397	TR5GP	3186	TR5	2238	.040
<b>Escalade EXT</b>													
2013-07	V8 6.2L		IZTR5B11	1465	TR5AHX	94567	TR5IX	7397	TR5GP	3186	TR5	2238	.040
2006-02	V8 6.0L		IZTR5B11	1465	TR5AHX	94567	TR5IX	7397	TR5GP	3186	TR5	2238	.040
<b>Fleetwood</b>													
1996-94	V8 5.7L		PTR5F-11	6579			TR55IX	7164	TR55GP	3403	TR55	3951	.050
1993	V8 5.7L		UR4	6630			UR4IX	7401	UR4GP	2869	UR4	6630	.035
1992-91	V8 4.9L		TR55	3951			TR55IX	7164	TR55GP	3403	TR55	3951	.060
1990-88	V8 4.5L		TR55	3951			TR55IX	7164	TR55GP	3403	TR55	3951	.060
1987	V8 4.1L		TR55	3951			TR55IX	7164	TR55GP	3403	TR55	3951	.060
1986	V8 4.1L		TR55	3951			TR55IX	7164	TR55GP	3403	TR55	3951	.060
	V8 5.0L		FR45	3686					FR45GP	3072	FR45	3686	.060
1985	V8 4.1L		TR55	3951			TR55IX	7164	TR55GP	3403	TR55	3951	.060
<b>Seville</b>													
2004-00	V8 4.6L		PTR5F-11	6579	TR5AHX	94567	TR55IX	7164	TR55GP	3403	TR55	3951	.050
1999-94	V8 4.6L		PTR5F-11	6579			TR55IX	7164	TR55GP	3403	TR55	3951	.050
1993	V8 4.6L		TR55	3951			TR55IX	7164	TR55GP	3403	TR55	3951	.050



Year	Cyl. L	Notes	Original Equipment		Ruthenium HX		Iridium IX		G-Power		V-Power		Gap
			Part	Stock	Part	Stock	Part	Stock	Part	Stock	Part	Stock	
<b>CADILLAC (Cont'd)</b>													
Seville (Cont'd)													
1993	V8 4.9L		TR55	3951			TR55IX	7164	TR55GP	3403	TR55	3951	.060
1992-91	V8 4.9L		TR55	3951			TR55IX	7164	TR55GP	3403	TR55	3951	.060
1990-88	V8 4.5L		TR55	3951			TR55IX	7164	TR55GP	3403	TR55	3951	.060
1987-85	V8 4.1L		TR55	3951			TR55IX	7164	TR55GP	3403	TR55	3951	.060
<b>SRX</b>													
2016-12	V6 3.6L		<b>ILTR6E11</b>	<b>90117</b>	LTR6AHX	91276	LTR6IX-11	6509	LTR6GP	90198			.044
2011-10	V6 2.8L		<b>ILTR6E11</b>	<b>90117</b>	LTR6BHX	90495	LTR6IX-11	6509	LTR6GP	90198			.044
	V6 3.0L		<b>ILTR6E11</b>	<b>90117</b>	LTR6AHX	91276	LTR6IX-11	6509	LTR6GP	90198			.044
2009-07	V6 3.6L		PLTR6A-10G	3587	LTR6AHX	91276	LTR6IX-11	6509	LTR6GP	90198			.044
	V8 4.6L		PTR5C-13	7740	TR5AHX	94567	TR55IX	7164	TR55GP	3403	TR55	3951	.052
2006	V6 3.6L		PLTR6A-10G	3587	LTR6AHX	91276	LTR6IX-11	6509	LTR6GP	90198			.044
	V8 4.6L		PTR5D-10	3784	TR5AHX	94567	TR5IX	7397	TR5GP	3186	TR5	2238	.040
2005-04	V6 3.6L		PLTR6A-10G	3587	LTR6AHX	91276	LTR6IX-11	6509	LTR6GP	90198			.040
	V8 4.6L		PTR5D-10	3784	TR5AHX	94567	TR5IX	7397	TR5GP	3186	TR5	2238	.040
<b>STS</b>													
2011	V6 3.6L		PLTR6A-10G	3587	LTR6AHX	91276	LTR6IX-11	6509	LTR6GP	90198			.044
2010	V6 3.6L		PLTR6A-10G	3587	LTR6AHX	91276	LTR6IX-11	6509	LTR6GP	90198			.044
	V8 4.6L		PTR5C-13	7740	TR5AHX	94567	TR55IX	7164	TR55GP	3403	TR55	3951	.052
2009-07	V6 3.6L		PLTR6A-10G	3587	LTR6AHX	91276	LTR6IX-11	6509	LTR6GP	90198			.044
	V8 4.4L		TR7IX	3690			TR7IX	3690					.040
	V8 4.6L		PTR5C-13	7740	TR5AHX	94567	TR55IX	7164	TR55GP	3403	TR55	3951	.052
2006	V6 3.6L		PLTR6A-10G	3587	LTR6AHX	91276	LTR6IX-11	6509	LTR6GP	90198			.044
	V8 4.4L		TR7IX	3690			TR7IX	3690					.040
	V8 4.6L		PTR5D-10	3784	TR5AHX	94567	TR5IX	7397	TR5GP	3186	TR5	2238	.040
2005	V6 3.6L		PLTR6A-10G	3587	LTR6AHX	91276	LTR6IX-11	6509	LTR6GP	90198			.040
	V8 4.6L		PTR5D-10	3784	TR5AHX	94567	TR5IX	7397	TR5GP	3186	TR5	2238	.040
<b>XLR</b>													
2009-07	V8 4.4L		TR7IX	3690			TR7IX	3690					.040
	V8 4.6L		PTR5C-13	7740	TR5AHX	94567	TR55IX	7164	TR55GP	3403	TR55	3951	.052
2006	V8 4.4L		TR7IX	3690			TR7IX	3690					.040
	V8 4.6L		PTR5D-10	3784	TR5AHX	94567	TR5IX	7397	TR5GP	3186	TR5	2238	.040
2005-04	V8 4.6L		PTR5D-10	3784	TR5AHX	94567	TR5IX	7397	TR5GP	3186	TR5	2238	.040
<b>XTS</b>													
2018-16	V6 3.6L	Naturally Aspirated	<b>ILTR6E11</b>	<b>90117</b>	LTR6AHX	91276	LTR6IX-11	6509	LTR6GP	90198			.044
		Turbo			LTR7BHX	95605							.036
2015-14	V6 3.6L	Naturally Aspirated	<b>ILTR6E11</b>	<b>90117</b>	LTR6AHX	91276	LTR6IX-11	6509	LTR6GP	90198			.044
		Turbo	<b>ILTR7E9</b>	<b>90543</b>	LTR7BHX	95605	LTR7IX-11	6510					.036
2013	V6 3.6L		<b>ILTR6E11</b>	<b>90117</b>	LTR6AHX	91276	LTR6IX-11	6509	LTR6GP	90198			.044
<b>CHEVROLET</b>													
<b>Astro</b>													
2005-03	V6 4.3L		ITR4A15	5599	TR5AHX	94567	TR55IX	7164	TR55GP	3403	TR55	3951	.060
2002-98	V6 4.3L		<b>ITR4A15</b>	<b>5599</b>	TR5AHX	94567	TR55IX	7164	TR55GP	3403	TR55	3951	.060
1997	V6 4.3L		ITR4A15	5599	TR5AHX	94567	TR55IX	7164	TR55GP	3403	TR55	3951	.060
1996	V6 4.3L		ITR4A15	5599			TR55IX	7164	TR55GP	3403	TR55	3951	.060
1995-91	V6 4.3L		UR5	2771			UR5IX	7177	UR5GP	3547	UR5	2771	.035
1990-85	L4 2.5L		UR55	2248			UR55IX	7272			UR55	2248	.060
	V6 4.3L		UR5	2771			UR5IX	7177	UR5GP	3547	UR5	2771	.035
<b>Avalanche</b>													
2013-10	V8 5.3L		IZTR5B11	1465	TR5AHX	94567	TR5IX	7397	TR5GP	3186	TR5	2238	.040
2009-07	V8 5.3L		IZTR5B11	1465	TR5AHX	94567	TR5IX	7397	TR5GP	3186	TR5	2238	.040
	V8 6.0L		IZTR5B11	1465	TR5AHX	94567	TR5IX	7397	TR5GP	3186	TR5	2238	.040
<b>Avalanche 1500</b>													
2006	V8 5.3L		IZTR5B11	1465	TR5AHX	94567	TR5IX	7397	TR5GP	3186	TR5	2238	.040
2005-02	V8 5.3L		PTR5D-10	3784	TR5AHX	94567	TR5IX	7397	TR5GP	3186	TR5	2238	.040
<b>Avalanche 2500</b>													
2006-03	V8 8.1L		PZTR5A-15	7862	TR5AHX	94567	TR55IX	7164	TR55GP	3403	TR55	3951	.060
2002	V8 8.1L		<b>PZTR5A-15</b>	<b>7862</b>	TR5AHX	94567	TR55IX	7164	TR55GP	3403	TR55	3951	.060

**Bold denotes NGK OE Manufacturer and/or OE Service Part**  
NOT BOLD denotes OE Equivalent Part

Note: Due to different operating or engine conditions, alternate heat range plugs may be required.

93

**Le texte en gras désigne une pièce d'équipement originale du manufacturier NGK et/ou pièce d'équipement originale de service**  
Le texte non en gras désigne une pièce d'équipement originale équivalente

Note: En raison de différences au niveau du fonctionnement ou des conditions du moteur, d'autres types de bougies avec variation de chaleur peuvent être nécessaires



Year	Cyl. L	Notes	Original Equipment		Ruthenium HX		Iridium IX		G-Power		V-Power		Gap
			Part	Stock	Part	Stock	Part	Stock	Part	Stock	Part	Stock	
<b>CHEVROLET (Cont'd)</b>													
<b>Aveo</b>													
2011-09	L4 1.6L		<b>ZFR6U-9</b>	<b>90318</b>	FR6AHX-S	94279	ZFR6FIX-11	6441	ZFR6FGP	7100	ZFR6U-9	90318	.036
2008-04	L4 1.6L		<b>BKR6E-11</b>	<b>2756</b>	FR6BHX-S	95159	BKR6EIX-11	3764	BKR6EGP	7092	BKR6E-11	2756	.044
<b>Aveo5</b>													
2011-09	L4 1.6L		<b>ZFR6U-9</b>	<b>90318</b>	FR6AHX-S	94279	ZFR6FIX-11	6441	ZFR6FGP	7100	ZFR6U-9	90318	.036
2008-06	L4 1.6L		<b>BKR6E-11</b>	<b>2756</b>	FR6BHX-S	95159	BKR6EIX-11	3764	BKR6EGP	7092	BKR6E-11	2756	.044
<b>Beretta</b>													
1996-95	L4 2.2L		PZTR5A-15	7862			TR55-1IX	7316	TR55-1GP	7159	TR55-1	2683	.060
	V6 3.1L		ITR4A15	5599			TR55IX	7164	TR55GP	3403	TR55	3951	.060
1994	L4 2.2L		PZTR5A-15	7862			TR55-1IX	7316	TR55-1GP	7159	TR55-1	2683	.060
	L4 2.3L		BKR5E	7938			BKR5EIX	6341	BKR5EGP	7090	BKR5E	7938	.035
	V6 3.1L		ITR4A15	5599			TR55IX	7164	TR55GP	3403	TR55	3951	.060
1993-92	L4 2.2L		TR4	3754			TR4IX	7300	TR4GP	2815	TR4	3754	.045
	L4 2.3L		BKR5E	7938			BKR5EIX	6341	BKR5EGP	7090	BKR5E	7938	.035
	V6 3.1L		TR4	3754			TR4IX	7300	TR4GP	2815	TR4	3754	.045
1991-90	L4 2.2L		TR4	3754			TR4IX	7300	TR4GP	2815	TR4	3754	.035
	L4 2.3L		FR4	5155			BKR4EIX	5693	FR4GP	2685	FR4	5155	.035
	V6 3.1L		TR4	3754			TR4IX	7300	TR4GP	2815	TR4	3754	.045
1989-87	L4 2.0L		TR4	3754			TR4IX	7300	TR4GP	2815	TR4	3754	.035
	V6 2.8L		TR4	3754			TR4IX	7300	TR4GP	2815	TR4	3754	.045
<b>Blazer</b>													
2005-98	V6 4.3L		<b>ITR4A15</b>	<b>5599</b>	TR5AHX	94567	TR55IX	7164	TR55GP	3403	TR55	3951	.060
1997	V6 4.3L		PZTR5A-15	7862	TR5AHX	94567	TR55IX	7164	TR55GP	3403	TR55	3951	.060
1996	V6 4.3L		PZTR5A-15	7862			TR55IX	7164	TR55GP	3403	TR55	3951	.060
1995	V6 4.3L		UR5	2771			UR5IX	7177	UR5GP	3547	UR5	2771	.045
1994-88	V8 5.7L		UR5	2771			UR5IX	7177	UR5GP	3547	UR5	2771	.035
1987	V8 5.0L		UR5	2771			UR5IX	7177	UR5GP	3547	UR5	2771	.035
	V8 5.7L		UR5	2771			UR5IX	7177	UR5GP	3547	UR5	2771	.035
<b>C10</b>													
1986-85	V6 4.3L		UR5	2771			UR5IX	7177	UR5GP	3547	UR5	2771	.035
	V8 5.0L	Vin F	UR5	2771			UR5IX	7177	UR5GP	3547	UR5	2771	.045
		Vin H	UR4	6630			UR4IX	7401	UR4GP	2869	UR4	6630	.045
	V8 5.7L	Vin L	UR5	2771			UR5IX	7177	UR5GP	3547	UR5	2771	.045
		Vin M	YR5	7052			YR5IX	7516	YR5GP	2953	YR5	7052	.045
<b>C10 Suburban</b>													
1986-85	V8 5.0L	Vin F	UR5	2771			UR5IX	7177	UR5GP	3547	UR5	2771	.045
		Vin H	UR4	6630			UR4IX	7401	UR4GP	2869	UR4	6630	.045
	V8 5.7L	Vin L	UR5	2771			UR5IX	7177	UR5GP	3547	UR5	2771	.045
		Vin M	YR5	7052			YR5IX	7516	YR5GP	2953	YR5	7052	.045
<b>C20</b>													
1986	L6 4.8L		YR5	7052			YR5IX	7516	YR5GP	2953	YR5	7052	.035
	V6 4.3L		UR5	2771			UR5IX	7177	UR5GP	3547	UR5	2771	.035
	V8 5.0L		UR4	6630			UR4IX	7401	UR4GP	2869	UR4	6630	.045
	V8 5.7L	Vin L	UR5	2771			UR5IX	7177	UR5GP	3547	UR5	2771	.035
		Vin M	YR5	7052			YR5IX	7516	YR5GP	2953	YR5	7052	.045
	V8 7.4L		YR5	7052			YR5IX	7516	YR5GP	2953	YR5	7052	.045
1985	L6 4.8L		YR5	7052			YR5IX	7516	YR5GP	2953	YR5	7052	.035
	V6 4.3L		UR5	2771			UR5IX	7177	UR5GP	3547	UR5	2771	.035
	V8 5.0L		UR4	6630			UR4IX	7401	UR4GP	2869	UR4	6630	.045
	V8 5.7L	Vin L	UR5	2771			UR5IX	7177	UR5GP	3547	UR5	2771	.045
		Vin M	YR5	7052			YR5IX	7516	YR5GP	2953	YR5	7052	.045
	V8 7.4L		YR5	7052			YR5IX	7516	YR5GP	2953	YR5	7052	.045
<b>C20 Suburban</b>													
1986-85	V8 5.0L		UR4	6630			UR4IX	7401	UR4GP	2869	UR4	6630	.045
	V8 5.7L	Vin L	UR5	2771			UR5IX	7177	UR5GP	3547	UR5	2771	.045
		Vin M	YR5	7052			YR5IX	7516	YR5GP	2953	YR5	7052	.045
	V8 7.4L		YR5	7052			YR5IX	7516	YR5GP	2953	YR5	7052	.045



Year	Cyl. L	Notes	Original Equipment		Ruthenium HX		Iridium IX		G-Power		V-Power		Gap
			Part	Stock	Part	Stock	Part	Stock	Part	Stock	Part	Stock	
<b>CHEVROLET (Cont'd)</b>													
<b>C30</b>													
1986-85	L6 4.8L		YR5	7052			YR5IX	7516	YR5GP	2953	YR5	7052	.035
	V8 5.7L		YR5	7052			YR5IX	7516	YR5GP	2953	YR5	7052	.045
	V8 7.4L		YR5	7052			YR5IX	7516	YR5GP	2953	YR5	7052	.045
<b>C50</b>													
1990-86	V8 5.7L		YR5	7052			YR5IX	7516	YR5GP	2953	YR5	7052	.045
<b>C70</b>													
1990	V8 6.0L		UR4	6630			UR4IX	7401	UR4GP	2869	UR4	6630	.035
	V8 7.0L	CARB	YR5	7052			YR5IX	7516	YR5GP	2953	YR5	7052	.045
1989-86	V8 6.0L		YR5	7052			YR5IX	7516	YR5GP	2953	YR5	7052	.045
	V8 7.0L		YR5	7052			YR5IX	7516	YR5GP	2953	YR5	7052	.045
<b>C1500</b>													
1999	V8 5.0L		<b>ITR4A15</b>	<b>5599</b>	TR5AHX	94567	TR55IX	7164	TR55GP	3403	TR55	3951	.060
	V8 5.7L		<b>ITR4A15</b>	<b>5599</b>	TR5AHX	94567	TR55IX	7164	TR55GP	3403	TR55	3951	.060
1998-97	V6 4.3L		<b>ITR4A15</b>	<b>5599</b>	TR5AHX	94567	TR55IX	7164	TR55GP	3403	TR55	3951	.060
	V8 5.0L		<b>ITR4A15</b>	<b>5599</b>	TR5AHX	94567	TR55IX	7164	TR55GP	3403	TR55	3951	.060
	V8 5.7L		<b>ITR4A15</b>	<b>5599</b>	TR5AHX	94567	TR55IX	7164	TR55GP	3403	TR55	3951	.060
1996	V6 4.3L		<b>ITR4A15</b>	<b>5599</b>			TR55IX	7164	TR55GP	3403	TR55	3951	.060
	V8 5.0L		<b>ITR4A15</b>	<b>5599</b>			TR55IX	7164	TR55GP	3403	TR55	3951	.060
	V8 5.7L		<b>ITR4A15</b>	<b>5599</b>			TR55IX	7164	TR55GP	3403	TR55	3951	.060
1995-94	V6 4.3L		UR5	2771			UR5IX	7177	UR5GP	3547	UR5	2771	.045
	V8 5.0L		UR5	2771			UR5IX	7177	UR5GP	3547	UR5	2771	.035
	V8 5.7L		UR5	2771			UR5IX	7177	UR5GP	3547	UR5	2771	.035
1993-92	V6 4.3L		UR5	2771			UR5IX	7177	UR5GP	3547	UR5	2771	.035
	V8 5.0L		UR5	2771			UR5IX	7177	UR5GP	3547	UR5	2771	.035
	V8 5.7L	GAS	UR5	2771			UR5IX	7177	UR5GP	3547	UR5	2771	.035
	V8 7.4L		UR5	2771			UR5IX	7177	UR5GP	3547	UR5	2771	.035
1991-90	V6 4.3L		UR5	2771			UR5IX	7177	UR5GP	3547	UR5	2771	.035
	V8 5.0L		UR5	2771			UR5IX	7177	UR5GP	3547	UR5	2771	.035
	V8 5.7L		UR5	2771			UR5IX	7177	UR5GP	3547	UR5	2771	.035
	V8 7.4L		UR5	2771			UR5IX	7177	UR5GP	3547	UR5	2771	.035
1989-88	V6 4.3L		UR5	2771			UR5IX	7177	UR5GP	3547	UR5	2771	.035
	V8 5.0L		UR5	2771			UR5IX	7177	UR5GP	3547	UR5	2771	.035
	V8 5.7L		UR5	2771			UR5IX	7177	UR5GP	3547	UR5	2771	.035
<b>C1500 Suburban</b>													
1999-97	V8 5.7L		<b>ITR4A15</b>	<b>5599</b>	TR5AHX	94567	TR55IX	7164	TR55GP	3403	TR55	3951	.060
1996	V8 5.7L		<b>ITR4A15</b>	<b>5599</b>			TR55IX	7164	TR55GP	3403	TR55	3951	.060
1995-92	V8 5.7L		UR5	2771			UR5IX	7177	UR5GP	3547	UR5	2771	.035
<b>C2500</b>													
2000	V8 5.7L		<b>ITR4A15</b>	<b>5599</b>	TR5AHX	94567	TR55IX	7164	TR55GP	3403	TR55	3951	.060
	V8 7.4L		PTR4G-15	1209	TR5AHX	94567	TR55IX	7164	TR55GP	3403	TR55	3951	.060
1999-97	V8 5.0L		<b>ITR4A15</b>	<b>5599</b>	TR5AHX	94567	TR55IX	7164	TR55GP	3403	TR55	3951	.060
	V8 5.7L		<b>ITR4A15</b>	<b>5599</b>	TR5AHX	94567	TR55IX	7164	TR55GP	3403	TR55	3951	.060
	V8 7.4L		PTR4G-15	1209	TR5AHX	94567	TR55IX	7164	TR55GP	3403	TR55	3951	.060
1996	V8 5.0L		<b>ITR4A15</b>	<b>5599</b>			TR55IX	7164	TR55GP	3403	TR55	3951	.060
	V8 5.7L		<b>ITR4A15</b>	<b>5599</b>			TR55IX	7164	TR55GP	3403	TR55	3951	.060
	V8 7.4L		PTR4G-15	1209			TR55IX	7164	TR55GP	3403	TR55	3951	.060
1995-94	V6 4.3L		UR5	2771			UR5IX	7177	UR5GP	3547	UR5	2771	.045
	V8 5.0L		UR5	2771			UR5IX	7177	UR5GP	3547	UR5	2771	.035
	V8 5.7L		UR5	2771			UR5IX	7177	UR5GP	3547	UR5	2771	.035
	V8 7.4L		UR5	2771			UR5IX	7177	UR5GP	3547	UR5	2771	.035
1993-92	V6 4.3L		UR5	2771			UR5IX	7177	UR5GP	3547	UR5	2771	.035
	V8 5.0L		UR5	2771			UR5IX	7177	UR5GP	3547	UR5	2771	.035
	V8 5.7L	CNG	PTR4G-15	1209			TR55IX	7164	TR55GP	3403	TR55	3951	.060
	V8 7.4L	GAS	UR5	2771			UR5IX	7177	UR5GP	3547	UR5	2771	.035
1991	V6 4.3L		UR5	2771			UR5IX	7177	UR5GP	3547	UR5	2771	.035
	V8 5.0L		UR5	2771			UR5IX	7177	UR5GP	3547	UR5	2771	.035

**Bold denotes NGK OE Manufacturer and/or OE Service Part**  
NOT BOLD denotes OE Equivalent Part

**Le texte en gras désigne une pièce d'équipement originale du manufacturier NGK et/ou pièce d'équipement originale de service**  
Le texte non en gras désigne une pièce d'équipement originale équivalente

Note: Due to different operating or engine conditions, alternate heat range plugs may be required.

Note: En raison de différences au niveau du fonctionnement ou des conditions du moteur, d'autres types de bougies avec variation de chaleur peuvent être nécessaires





Year	Cyl. L	Notes	Original Equipment		Ruthenium HX		Iridium IX		G-Power		V-Power		Gap
			Part	Stock	Part	Stock	Part	Stock	Part	Stock	Part	Stock	
<b>CHEVROLET (Cont'd)</b>													
<b>C2500 (Cont'd)</b>													
1991	V8 5.7L		UR5	2771			UR5IX	7177	UR5GP	3547	UR5	2771	.035
	V8 7.4L		UR5	2771			UR5IX	7177	UR5GP	3547	UR5	2771	.035
1990-88	V6 4.3L		UR5	2771			UR5IX	7177	UR5GP	3547	UR5	2771	.035
	V8 5.0L		UR5	2771			UR5IX	7177	UR5GP	3547	UR5	2771	.035
	V8 5.7L		UR5	2771			UR5IX	7177	UR5GP	3547	UR5	2771	.035
<b>C2500 Suburban</b>													
1999-97	V8 5.7L		<b>ITR4A15</b>	<b>5599</b>	TR5AHX	94567	TR55IX	7164	TR55GP	3403	TR55	3951	.060
	V8 7.4L		PTR4G-15	1209	TR5AHX	94567	TR55IX	7164	TR55GP	3403	TR55	3951	.060
1996	V8 5.7L		<b>ITR4A15</b>	<b>5599</b>			TR55IX	7164	TR55GP	3403	TR55	3951	.060
	V8 7.4L		PTR4G-15	1209			TR55IX	7164	TR55GP	3403	TR55	3951	.060
1995-92	V8 5.7L		UR5	2771			UR5IX	7177	UR5GP	3547	UR5	2771	.035
	V8 7.4L		UR5	2771			UR5IX	7177	UR5GP	3547	UR5	2771	.035
<b>C3500</b>													
2000-97	V8 5.7L		<b>ITR4A15</b>	<b>5599</b>	TR5AHX	94567	TR55IX	7164	TR55GP	3403	TR55	3951	.060
	V8 7.4L		PTR4G-15	1209	TR5AHX	94567	TR55IX	7164	TR55GP	3403	TR55	3951	.060
1996	V8 5.7L		<b>ITR4A15</b>	<b>5599</b>			TR55IX	7164	TR55GP	3403	TR55	3951	.060
	V8 7.4L		PTR4G-15	1209			TR55IX	7164	TR55GP	3403	TR55	3951	.060
1995-88	V8 5.7L		UR5	2771			UR5IX	7177	UR5GP	3547	UR5	2771	.035
	V8 7.4L		UR5	2771			UR5IX	7177	UR5GP	3547	UR5	2771	.035
<b>C3500HD</b>													
2002-01	V8 8.1L		<b>PZTR5A-15</b>	<b>7862</b>	TR5AHX	94567	TR55IX	7164	TR55GP	3403	TR55	3951	.060
2000-97	V8 7.4L		PTR4G-15	1209	TR5AHX	94567	TR55IX	7164	TR55GP	3403	TR55	3951	.060
1996	V8 7.4L		PTR4G-15	1209			TR55IX	7164	TR55GP	3403	TR55	3951	.060
1995-91	V8 5.7L		UR5	2771			UR5IX	7177	UR5GP	3547	UR5	2771	.035
<b>C4500 Kodiak</b>													
2009-08	V8 6.6L	DIESEL	Y1033AS	90046									
	V8 8.1L		PZTR5A-15	7862	TR5AHX	94567	TR55IX	7164	TR55GP	3403	TR55	3951	.060
2007	V8 6.6L	DIESEL	Y1033AS	90046									
2006	V8 6.6L	DIESEL, w/ Hex Threads Located Middle of Glow Plug	Y1033AS	90046									
		DIESEL, w/ Hex Threads Located Near Top of Glow Plug (LLY Engine Only)	Y1032AS	97788									
2005	V8 6.6L	DIESEL	Y1032AS	97788									
2004	V8 6.6L	Vin 2, DIESEL	Y1032AS	97788									
<b>C5500 Kodiak</b>													
2009-08	V8 6.6L	DIESEL	Y1033AS	90046									
	V8 8.1L		PZTR5A-15	7862	TR5AHX	94567	TR55IX	7164	TR55GP	3403	TR55	3951	.060
2007	V8 6.6L	DIESEL	Y1033AS	90046									
2006	V8 6.6L	DIESEL, w/ Hex Threads Located Middle of Glow Plug	Y1033AS	90046									
		DIESEL, w/ Hex Threads Located Near Top of Glow Plug (LLY Engine Only)	Y1032AS	97788									
2005	V8 6.6L	DIESEL	Y1032AS	97788									
2004	V8 6.6L	Vin 2, DIESEL	Y1032AS	97788									
<b>C6500 Kodiak</b>													
2009-08	V8 8.1L		PZTR5A-15	7862	TR5AHX	94567	TR55IX	7164	TR55GP	3403	TR55	3951	.060
2000-99	V8 7.4L		PTR4G-15	1209	TR5AHX	94567	TR55IX	7164	TR55GP	3403	TR55	3951	.060
<b>C7500 Kodiak</b>													
2009-08	V8 8.1L		PZTR5A-15	7862	TR5AHX	94567	TR55IX	7164	TR55GP	3403	TR55	3951	.060
2000-99	V8 7.4L		PTR4G-15	1209	TR5AHX	94567	TR55IX	7164	TR55GP	3403	TR55	3951	.060
<b>Camaro</b>													
2018-17	L4 2.0L		<b>ILTR6M9G</b>	<b>94489</b>	LTR6BHX	90495							.036
	V8 6.2L	Naturally Aspirated	ILTR5B11	3474	LTR5AHX	90220	LTR5IX-11	4344	LTR5GP	5019			.044



Year	Cyl. L	Notes	Original Equipment		Ruthenium HX		Iridium IX		G-Power		V-Power		Gap
			Part	Stock	Part	Stock	Part	Stock	Part	Stock	Part	Stock	
<b>CHEVROLET (Cont'd)</b>													
<b>Camaro (Cont'd)</b>													
2018-17		Supercharged	ILTR5D	5476			LTR5IX-11	4344	LTR5GP	5019			.032
2016	L4 2.0L		<b>ILTR6M9G</b>	<b>94489</b>	LTR6BHX	90495							.036
	V8 6.2L	Naturally Aspirated	ILTR5B11	3474	LTR5AHX	90220	LTR5IX-11	4344	LTR5GP	5019			.044
2015-14	V6 3.6L		<b>ILTR6E11</b>	<b>90117</b>	LTR6AHX	91276	LTR6IX-11	6509	LTR6GP	90198			.044
	V8 6.2L	Naturally Aspirated	IZTR5B11	1465	TR5AHX	94567	TR5IX	7397	TR5GP	3186	TR5	2238	.040
		Supercharged	ITR6G9	90156			TR6IX	3689	TR6GP	5141	TR6	4177	.040
V8 7.0L				TR6AHX	92714	TR6IX	3689	TR6GP	5141	TR6	4177	.040	
2013-12	V6 3.6L		<b>ILTR6E11</b>	<b>90117</b>	LTR6AHX	91276	LTR6IX-11	6509	LTR6GP	90198			.044
	V8 6.2L	Naturally Aspirated	IZTR5B11	1465	TR5AHX	94567	TR5IX	7397	TR5GP	3186	TR5	2238	.040
		Supercharged	ITR6G9	90156			TR6IX	3689	TR6GP	5141	TR6	4177	.040
2011	V6 3.6L		<b>ILTR6E11</b>	<b>90117</b>	LTR6AHX	91276	LTR6IX-11	6509	LTR6GP	90198			.044
	V8 6.2L		IZTR5B11	1465	TR5AHX	94567	TR5IX	7397	TR5GP	3186	TR5	2238	.040
2010	V6 3.6L		PLTR6A-10G	3587	LTR6AHX	91276	LTR6IX-11	6509	LTR6GP	90198			.044
	V8 6.2L		IZTR5B11	1465	TR5AHX	94567	TR5IX	7397	TR5GP	3186	TR5	2238	.040
2002-98	V6 3.8L		ITR4A15	5599	TR4BHX	97100	TR55IX	7164	TR55GP	3403	TR55	3951	.060
	V8 5.7L		PTR5D-10	3784	TR5AHX	94567	TR5IX	7397	TR5GP	3186	TR5	2238	.040
1997	V6 3.8L		ITR4A15	5599	TR4BHX	97100	TR55IX	7164	TR55GP	3403	TR55	3951	.060
	V8 5.7L		PTR5F-11	6579	TR5AHX	94567	TR55IX	7164	TR55GP	3403	TR55	3951	.050
1996	V6 3.8L		ITR4A15	5599			TR55IX	7164	TR55GP	3403	TR55	3951	.060
	V8 5.7L		PTR5F-11	6579			TR55IX	7164	TR55GP	3403	TR55	3951	.050
1995	V6 3.4L		BPR6FS	2623			UR6IX	7348	UR6GP	7966	UR6	7773	.045
	V6 3.8L		ITR4A15	5599			TR55IX	7164	TR55GP	3403	TR55	3951	.060
	V8 5.7L		TR55	3951			TR55IX	7164	TR55GP	3403	TR55	3951	.050
1994-93	V6 3.4L		BPR6FS	2623			UR6IX	7348	UR6GP	7966	UR6	7773	.045
	V8 5.7L		TR55	3951			TR55IX	7164	TR55GP	3403	TR55	3951	.050
1992-90	V6 3.1L		UR5	2771			UR5IX	7177	UR5GP	3547	UR5	2771	.045
	V8 5.0L		UR4	6630			UR4IX	7401	UR4GP	2869	UR4	6630	.035
	V8 5.7L	Aluminum Heads	FR4	5155			BKR4EIX	5693	FR4GP	2685	FR4	5155	.035
Cast Iron Heads		UR4	6630			UR4IX	7401	UR4GP	2869	UR4	6630	.035	
1989-88	V6 2.8L		UR5	2771			UR5IX	7177	UR5GP	3547	UR5	2771	.045
	V8 5.0L		UR4	6630			UR4IX	7401	UR4GP	2869	UR4	6630	.035
	V8 5.7L	Aluminum Heads	FR4	5155			BKR4EIX	5693	FR4GP	2685	FR4	5155	.035
Cast Iron Heads		UR4	6630			UR4IX	7401	UR4GP	2869	UR4	6630	.035	
1987	V6 2.8L		UR5	2771			UR5IX	7177	UR5GP	3547	UR5	2771	.045
	V8 5.0L	CARB	UR4	6630			UR4IX	7401	UR4GP	2869	UR4	6630	.035
		FI	UR5	2771			UR5IX	7177	UR5GP	3547	UR5	2771	.035
	V8 5.7L	Aluminum Heads	FR4	5155			BKR4EIX	5693	FR4GP	2685	FR4	5155	.035
Cast Iron Heads		UR4	6630			UR4IX	7401	UR4GP	2869	UR4	6630	.035	
1986-85	L4 2.5L		UR55	2248			UR55IX	7272			UR55	2248	.060
	V6 2.8L		UR5	2771			UR5IX	7177	UR5GP	3547	UR5	2771	.045
	V8 5.0L	Vin F	UR5	2771			UR5IX	7177	UR5GP	3547	UR5	2771	.035
		Vin G	UR5	2771			UR5IX	7177	UR5GP	3547	UR5	2771	.035
Vin H	UR4	6630			UR4IX	7401	UR4GP	2869	UR4	6630	.045		
<b>Caprice</b>													
2017-12	V6 3.6L		<b>ILTR6E11</b>	<b>90117</b>	LTR6AHX	91276	LTR6IX-11	6509	LTR6GP	90198			.044
	V8 6.0L		IZTR5B11	1465	TR5AHX	94567	TR5IX	7397	TR5GP	3186	TR5	2238	.040
2011	V8 6.0L		IZTR5B11	1465	TR5AHX	94567	TR5IX	7397	TR5GP	3186	TR5	2238	.040
1996-94	V8 4.3L		PZTR5A-15	7862			TR55IX	7164	TR55GP	3403	TR55	3951	.050
	V8 5.7L		PTR5F-11	6579			TR55IX	7164	TR55GP	3403	TR55	3951	.050
1993-92	V6 4.3L		UR5	2771			UR5IX	7177	UR5GP	3547	UR5	2771	.035
	V8 5.0L		UR4	6630			UR4IX	7401	UR4GP	2869	UR4	6630	.035
	V8 5.7L		UR5	2771			UR5IX	7177	UR5GP	3547	UR5	2771	.035
1991	V8 5.0L		UR4	6630			UR4IX	7401	UR4GP	2869	UR4	6630	.035
	V8 5.7L		UR5	2771			UR5IX	7177	UR5GP	3547	UR5	2771	.035
1990-89	V6 4.3L		UR4	6630			UR4IX	7401	UR4GP	2869	UR4	6630	.035
		CARB	FR45	3686					FR45GP	3072	FR45	3686	.060
	FI	UR4	6630			UR4IX	7401	UR4GP	2869	UR4	6630	.035	

**Bold denotes NGK OE Manufacturer and/or OE Service Part**  
NOT BOLD denotes OE Equivalent Part

**Le texte en gras désigne une pièce d'équipement originale du manufacturier NGK et/ou pièce d'équipement originale de service**  
Le texte non en gras désigne une pièce d'équipement originale équivalente

Note: Due to different operating or engine conditions, alternate heat range plugs may be required.

Note: En raison de différences au niveau du fonctionnement ou des conditions du moteur, d'autres types de bougies avec variation de chaleur peuvent être nécessaires



Year	Cyl. L	Notes	Original Equipment		Ruthenium HX		Iridium IX		G-Power		V-Power		Gap
			Part	Stock	Part	Stock	Part	Stock	Part	Stock	Part	Stock	
<b>CHEVROLET (Cont'd)</b>													
<b>Caprice (Cont'd)</b>													
1990-89	V8 5.7L		UR5	2771			UR5IX	7177	UR5GP	3547	UR5	2771	.035
1988-87	V6 4.3L		UR4	6630			UR4IX	7401	UR4GP	2869	UR4	6630	.035
	V8 5.0L	Vin H	UR4	6630			UR4IX	7401	UR4GP	2869	UR4	6630	.035
		Vin Y	FR45	3686					FR45GP	3072	FR45	3686	.060
1986	V8 5.7L		UR4	6630			UR4IX	7401	UR4GP	2869	UR4	6630	.035
	V6 4.3L		UR4	6630			UR4IX	7401	UR4GP	2869	UR4	6630	.035
		Vin H	UR4	6630			UR4IX	7401	UR4GP	2869	UR4	6630	.035
1985	V8 5.0L	Vin Y	FR45	3686					FR45GP	3072	FR45	3686	.060
		V8 5.7L	UR4	6630			UR4IX	7401	UR4GP	2869	UR4	6630	.045
	V6 3.8L		UR45	6945			UR45IX	7559	UR45GP	3207	UR45	6945	.060
	V6 4.3L		UR4	6630			UR4IX	7401	UR4GP	2869	UR4	6630	.035
	V8 5.0L		UR4	6630			UR4IX	7401	UR4GP	2869	UR4	6630	.045
	V8 5.7L	GAS	UR4	6630			UR4IX	7401	UR4GP	2869	UR4	6630	.045
<b>Captiva Sport</b>													
2015-13	L4 2.4L		<b>ILTR5D</b>	<b>5476</b>	LTR5AHX	90220	LTR5IX-11	4344	LTR5GP	5019			.036
2012	L4 2.4L		<b>ILTR5D</b>	<b>5476</b>	LTR5AHX	90220	LTR5IX-11	4344	LTR5GP	5019			.036
	V6 3.0L		<b>ILTR6E11</b>	<b>90117</b>	LTR6AHX	91276	LTR6IX-11	6509	LTR6GP	90198			.044
<b>Cavalier</b>													
2005-03	L4 2.2L		<b>ILTR5C11</b>	<b>5581</b>			LTR5IX-11	4344	LTR5GP	5019			.044
2002	L4 2.2L	Vin 4, OHV	PTR5D-10	3784			TR5IX	7397	TR5GP	3186	TR5	2238	.040
		Vin F, DOHC	<b>ILTR5C11</b>	<b>5581</b>			LTR5IX-11	4344	LTR5GP	5019			.044
2001-98	L4 2.4L		PTR5C-13	7740	TR5AHX	94567	TR55IX	7164	TR55GP	3403	TR55	3951	.050
	L4 2.2L		PTR5D-10	3784			TR5IX	7397	TR5GP	3186	TR5	2238	.040
1997	L4 2.4L		PTR5C-13	7740	TR5AHX	94567	TR55IX	7164	TR55GP	3403	TR55	3951	.050
	L4 2.2L		PZTR5A-15	7862			TR55-1IX	7316	TR55-1GP	7159	TR55-1	2683	.060
1996	L4 2.4L		PTR5C-13	7740	TR5AHX	94567	TR55IX	7164	TR55GP	3403	TR55	3951	.050
	L4 2.2L		PZTR5A-15	7862			TR55-1IX	7316	TR55-1GP	7159	TR55-1	2683	.060
1995	L4 2.2L		PZTR5A-15	7862			TR55-1IX	7316	TR55-1GP	7159	TR55-1	2683	.060
	L4 2.3L		PZTR5A-15	7862			TR55IX	7164	TR55GP	3403	TR55	3951	.060
1994	L4 2.2L		PZTR5A-15	7862			TR55-1IX	7316	TR55-1GP	7159	TR55-1	2683	.060
	V6 3.1L		TR4	3754			TR4IX	7300	TR4GP	2815	TR4	3754	.045
1993-92	L4 2.2L		TR4	3754			TR4IX	7300	TR4GP	2815	TR4	3754	.045
	V6 3.1L		TR4	3754			TR4IX	7300	TR4GP	2815	TR4	3754	.045
1991-90	L4 2.2L		TR4	3754			TR4IX	7300	TR4GP	2815	TR4	3754	.035
	V6 3.1L		TR4	3754			TR4IX	7300	TR4GP	2815	TR4	3754	.045
1989-87	L4 2.0L		TR4	3754			TR4IX	7300	TR4GP	2815	TR4	3754	.035
	V6 2.8L		TR4	3754			TR4IX	7300	TR4GP	2815	TR4	3754	.045
1986-85	L4 2.0L		UR5	2771			UR5IX	7177	UR5GP	3547	UR5	2771	.035
	V6 2.8L		UR5	2771			UR5IX	7177	UR5GP	3547	UR5	2771	.045
<b>Celebrity</b>													
1990	L4 2.5L		UR55	2248			UR55IX	7272			UR55	2248	.060
	V6 3.1L		TR4	3754			TR4IX	7300	TR4GP	2815	TR4	3754	.045
1989-87	L4 2.5L		UR55	2248			UR55IX	7272			UR55	2248	.060
	V6 2.8L		TR4	3754			TR4IX	7300	TR4GP	2815	TR4	3754	.045
1986-85	L4 2.5L		UR55	2248			UR55IX	7272			UR55	2248	.060
	V6 2.8L		UR5	2771			UR5IX	7177	UR5GP	3547	UR5	2771	.045
<b>Chevette</b>													
1987-85	L4 1.6L		UR5	2771			UR5IX	7177	UR5GP	3547	UR5	2771	.035
<b>Citation II</b>													
1985	L4 2.5L		UR55	2248			UR55IX	7272			UR55	2248	.060
	V6 2.8L		UR5	2771			UR5IX	7177	UR5GP	3547	UR5	2771	.045
<b>City Express</b>													
2018-15	L4 2.0L		DILKAR6A11	9029	LKAR6AHX	97292	LKAR6AIX-11	91187	LKAR6AGP	95830			.044
<b>Classic</b>													
2005-04	L4 2.2L		<b>ILTR5C11</b>	<b>5581</b>			LTR5IX-11	4344	LTR5GP	5019			.044



Year	Cyl. L	Notes	Original Equipment		Ruthenium HX		Iridium IX		G-Power		V-Power		Gap
			Part	Stock	Part	Stock	Part	Stock	Part	Stock	Part	Stock	
<b>CHEVROLET (Cont'd)</b>													
<b>Cobalt</b>													
2010-09	L4 2.0L		<b>ILTR5D</b>	<b>5476</b>			LTR5IX-11	4344	LTR5GP	5019			.036
	L4 2.2L		<b>ILTR5E11</b>	<b>91418</b>	LTR5AHX	90220	LTR5IX-11	4344	LTR5GP	5019			.044
2008	L4 2.0L		<b>ILTR5D</b>	<b>5476</b>			LTR5IX-11	4344	LTR5GP	5019			.036
	L4 2.2L		<b>ILTR5B11</b>	<b>3474</b>	LTR5AHX	90220	LTR5IX-11	4344	LTR5GP	5019			.044
	L4 2.4L		<b>ILTR5B11</b>	<b>3474</b>	LTR5AHX	90220	LTR5IX-11	4344	LTR5GP	5019			.044
2007	L4 2.0L		<b>IFR6V-10G</b>	<b>92085</b>	FR6BHX-S	95159	BKR6EIX	6418	BKR6EGP	7092	BKR6E	6962	.040
	L4 2.2L		<b>ILTR5B11</b>	<b>3474</b>	LTR5AHX	90220	LTR5IX-11	4344	LTR5GP	5019			.044
	L4 2.4L		<b>ILTR5B11</b>	<b>3474</b>	LTR5AHX	90220	LTR5IX-11	4344	LTR5GP	5019			.044
2006	L4 2.0L		<b>IFR6V-10G</b>	<b>92085</b>	FR6BHX-S	95159	BKR6EIX	6418	BKR6EGP	7092	BKR6E	6962	.040
	L4 2.2L		<b>ILTR5B11</b>	<b>3474</b>			LTR5IX-11	4344	LTR5GP	5019			.044
	L4 2.4L		<b>ILTR5B11</b>	<b>3474</b>	LTR5AHX	90220	LTR5IX-11	4344	LTR5GP	5019			.044
2005	L4 2.0L		<b>IFR6V-10G</b>	<b>92085</b>	FR6BHX-S	95159	BKR6EIX	6418	BKR6EGP	7092	BKR6E	6962	.040
	L4 2.2L		<b>ILTR5C11</b>	<b>5581</b>			LTR5IX-11	4344	LTR5GP	5019			.044
<b>Colorado</b>													
2018-17	L4 2.5L		<b>ILTR5L11</b>	<b>96329</b>	LTR5AHX	90220	LTR5IX-11	4344	LTR5GP	5019			.044
2016-15	L4 2.5L		<b>ILTR5L11</b>	<b>96329</b>	LTR5AHX	90220	LTR5IX-11	4344	LTR5GP	5019			.044
	V6 3.6L		<b>ILTR6E11</b>	<b>90117</b>	LTR6AHX	91276	LTR6IX-11	6509	LTR6GP	90198			.044
2012-09	L4 2.9L		<b>ILTR5E11</b>	<b>91418</b>	LTR5AHX	90220	LTR5IX-11	4344	LTR5GP	5019			.044
	L5 3.7L		<b>ILTR5E11</b>	<b>91418</b>	LTR5AHX	90220	LTR5IX-11	4344	LTR5GP	5019			.044
	V8 5.3L		IZTR5B11	1465	TR5AHX	94567	TR5IX	7397	TR5GP	3186	TR5	2238	.040
2008-07	L4 2.9L		<b>ILTR5E11</b>	<b>91418</b>	LTR5AHX	90220	LTR5IX-11	4344	LTR5GP	5019			.044
	L5 3.7L		<b>ILTR5E11</b>	<b>91418</b>	LTR5AHX	90220	LTR5IX-11	4344	LTR5GP	5019			.044
2006-04	L4 2.8L		<b>ILTR5E11</b>	<b>91418</b>	LTR5AHX	90220	LTR5IX-11	4344	LTR5GP	5019			.044
	L5 3.5L		<b>ILTR5E11</b>	<b>91418</b>	LTR5AHX	90220	LTR5IX-11	4344	LTR5GP	5019			.044
<b>Corsica</b>													
1996-94	L4 2.2L		PZTR5A-15	7862			TR55-1IX	7316	TR55-1GP	7159	TR55-1	2683	.060
	V6 3.1L		ITR4A15	5599			TR55IX	7164	TR55GP	3403	TR55	3951	.060
1993-92	L4 2.2L		TR4	3754			TR4IX	7300	TR4GP	2815	TR4	3754	.045
	V6 3.1L		TR4	3754			TR4IX	7300	TR4GP	2815	TR4	3754	.045
1991-90	L4 2.2L		TR4	3754			TR4IX	7300	TR4GP	2815	TR4	3754	.035
	V6 3.1L		TR4	3754			TR4IX	7300	TR4GP	2815	TR4	3754	.045
1989-87	L4 2.0L		TR4	3754			TR4IX	7300	TR4GP	2815	TR4	3754	.035
	V6 2.8L		TR4	3754			TR4IX	7300	TR4GP	2815	TR4	3754	.045
<b>Corvette</b>													
2018-15	V8 6.2L	Naturally Aspirated	ILTR5B11	3474	LTR5AHX	90220	LTR5IX-11	4344	LTR5GP	5019			.044
		Supercharged	ILTR5D	5476			LTR5IX-11	4344	LTR5GP	5019			.032
2014	V8 6.2L	Naturally Aspirated	ILTR5B11	3474	LTR5AHX	90220	LTR5IX-11	4344	LTR5GP	5019			.044
2013-09	V8 6.2L	Naturally Aspirated	IZTR5B11	1465	TR5AHX	94567	TR5IX	7397	TR5GP	3186	TR5	2238	.040
		Supercharged	ITR6G9	90156			TR6IX	3689	TR6GP	5141	TR6	4177	.040
2008	V8 7.0L				TR6AHX	92714	TR6IX	3689	TR6GP	5141	TR6	4177	.040
		Naturally Aspirated	IZTR5B11	1465	TR5AHX	94567	TR5IX	7397	TR5GP	3186	TR5	2238	.040
2007-06	V8 7.0L				TR6AHX	92714	TR6IX	3689	TR6GP	5141	TR6	4177	.040
		Naturally Aspirated	IZTR5B11	1465	TR5AHX	94567	TR5IX	7397	TR5GP	3186	TR5	2238	.040
2005	V8 6.0L		IZTR5B11	1465	TR5AHX	94567	TR5IX	7397	TR5GP	3186	TR5	2238	.040
2004	V8 5.7L		IZTR5B11	1465	TR5AHX	94567	TR5IX	7397	TR5GP	3186	TR5	2238	.040
2003-97	V8 5.7L		PTR5D-10	3784	TR5AHX	94567	TR5IX	7397	TR5GP	3186	TR5	2238	.040
1996	V8 5.7L	Vin 5	TR5	2238			TR5IX	7397	TR5GP	3186	TR5	2238	.050
		Vin P	TR55	3951			TR55IX	7164	TR55GP	3403	TR55	3951	.050
1995-93	V8 5.7L	Vin J	TR5	2238			TR5IX	7397	TR5GP	3186	TR5	2238	.050
		Vin P	TR55	3951			TR55IX	7164	TR55GP	3403	TR55	3951	.050
1992	V8 5.7L	Vin J	BKR5E-11	6953			BKR5EIX-11	5464	BKR5EGP	7090	BKR5E-11	6953	.050
		Vin P	TR55	3951			TR55IX	7164	TR55GP	3403	TR55	3951	.050
1991-90	V8 5.7L	Vin 8, Aluminum Heads	FR4	5155			BKR4EIX	5693	FR4GP	2685	FR4	5155	.035
		Vin 8, Cast Iron Heads	UR4	6630			UR4IX	7401	UR4GP	2869	UR4	6630	.045
		Vin J	BKR5E-11	6953			BKR5EIX-11	5464	BKR5EGP	7090	BKR5E-11	6953	.050

**Bold denotes NGK OE Manufacturer and/or OE Service Part**  
 NOT BOLD denotes OE Equivalent Part

Note: Due to different operating or engine conditions, alternate heat range plugs may be required.

**Le texte en gras désigne une pièce d'équipement originale du manufacturier NGK et/ou pièce d'équipement originale de service**  
 Le texte non en gras désigne une pièce d'équipement originale équivalente

Note: En raison de différences au niveau du fonctionnement ou des conditions du moteur, d'autres types de bougies avec variation de chaleur peuvent être nécessaires



Year	Cyl. L	Notes	Original Equipment		Ruthenium HX		Iridium IX		G-Power		V-Power		Gap
			Part	Stock	Part	Stock	Part	Stock	Part	Stock	Part	Stock	
<b>CHEVROLET (Cont'd)</b>													
<b>Corvette (Cont'd)</b>													
1989-88	V8 5.7L	Aluminum Heads	FR4	5155			BKR4EIX	5693	FR4GP	2685	FR4	5155	.035
		Cast Iron Heads	UR4	6630			UR4IX	7401	UR4GP	2869	UR4	6630	.045
1987-86	V8 5.7L	Aluminum Heads	FR4	5155			BKR4EIX	5693	FR4GP	2685	FR4	5155	.035
		Cast Iron Heads	UR5	2771			UR5IX	7177	UR5GP	3547	UR5	2771	.035
1985	V8 5.7L		UR5	2771			UR5IX	7177	UR5GP	3547	UR5	2771	.045
<b>Cruze</b>													
2018-17	L4 1.4L	Eng Desg LE2	ILNAR8B7G	91970									.028
2016	L4 1.4L	Eng Desg LE2, New Model	ILNAR8B7G	91970									.028
2015-11	L4 1.4L		<b>IFR7X7G</b>	<b>91039</b>	FR7BHX-S	92400							.027
	L4 1.8L		<b>IFR6Z7G</b>	<b>95609</b>	FR6AHX-S	94279							.027
<b>Cruze Limited</b>													
2016	L4 1.4L	Eng Desg LUV, Carryover Model	<b>IFR7X7G</b>	<b>91039</b>	FR7BHX-S	92400							.027
	L4 1.8L		<b>IFR6Z7G</b>	<b>95609</b>	FR6AHX-S	94279							.027
<b>El Camino</b>													
1987	V6 4.3L		UR4	6630			UR4IX	7401	UR4GP	2869	UR4	6630	.035
	V8 5.0L		UR4	6630			UR4IX	7401	UR4GP	2869	UR4	6630	.045
1986	V6 4.3L		UR5	2771			UR5IX	7177	UR5GP	3547	UR5	2771	.035
	V8 5.0L		UR5	2771			UR5IX	7177	UR5GP	3547	UR5	2771	.045
1985	V6 4.3L		UR4	6630			UR4IX	7401	UR4GP	2869	UR4	6630	.035
	V8 5.0L		UR4	6630			UR4IX	7401	UR4GP	2869	UR4	6630	.045
<b>Epica</b>													
2006-05	L6 2.5L		<b>IFR6E11</b>	<b>6741</b>	FR6AHX-S	94279	BKR6EIX-11	3764	BKR6EGP	7092	BKR6E-11	2756	.044
2004	L6 2.5L		PFR6G-11	5555	FR6AHX-S	94279	BKR6EIX-11	3764	BKR6EGP	7092	BKR6E-11	2756	.042
<b>Equinox</b>													
2018	L4 1.5L		ILNAR8B7G	91970									.028
	L4 2.0L		<b>ILTR6M9G</b>	<b>94489</b>	LTR6BHX	90495							.036
2017-13	L4 2.4L		<b>ILTR5D</b>	<b>5476</b>	LTR5AHX	90220	LTR5IX-11	4344	LTR5GP	5019			.036
	V6 3.6L		<b>ILTR6E11</b>	<b>90117</b>	LTR6AHX	91276	LTR6IX-11	6509	LTR6GP	90198			.044
2012-10	L4 2.4L		<b>ILTR5D</b>	<b>5476</b>	LTR5AHX	90220	LTR5IX-11	4344	LTR5GP	5019			.036
	V6 3.0L		<b>ILTR6E11</b>	<b>90117</b>	LTR6AHX	91276	LTR6IX-11	6509	LTR6GP	90198			.044
2009-08	V6 3.4L		<b>ITR4A15</b>	<b>5599</b>	TR4BHX	97100	TR55IX	7164	TR55GP	3403	TR55	3951	.060
	V6 3.6L		PLTR6A-10G	3587	LTR6AHX	91276	LTR6IX-11	6509	LTR6GP	90198			.044
2007-05	V6 3.4L		<b>ITR4A15</b>	<b>5599</b>	TR4BHX	97100	TR55IX	7164	TR55GP	3403	TR55	3951	.060
<b>Express 1500</b>													
2014-07	V6 4.3L		<b>ITR4A15</b>	<b>5599</b>	TR4BHX	97100	TR55IX	7164	TR55GP	3403	TR55	3951	.060
	V8 5.3L		IZTR5B11	1465	TR5AHX	94567	TR5IX	7397	TR5GP	3186	TR5	2238	.040
2006-03	V6 4.3L		<b>ITR4A15</b>	<b>5599</b>	TR5AHX	94567	TR55IX	7164	TR55GP	3403	TR55	3951	.060
	V8 5.3L		IZTR5B11	1465	TR5AHX	94567	TR5IX	7397	TR5GP	3186	TR5	2238	.040
2002-97	V6 4.3L		<b>ITR4A15</b>	<b>5599</b>	TR5AHX	94567	TR55IX	7164	TR55GP	3403	TR55	3951	.060
	V8 5.0L		<b>ITR4A15</b>	<b>5599</b>	TR5AHX	94567	TR55IX	7164	TR55GP	3403	TR55	3951	.060
	V8 5.7L		<b>ITR4A15</b>	<b>5599</b>	TR5AHX	94567	TR55IX	7164	TR55GP	3403	TR55	3951	.060
1996	V6 4.3L		<b>ITR4A15</b>	<b>5599</b>			TR55IX	7164	TR55GP	3403	TR55	3951	.060
	V8 5.0L		<b>ITR4A15</b>	<b>5599</b>			TR55IX	7164	TR55GP	3403	TR55	3951	.060
	V8 5.7L	Vin R, Central SFI(FuelSystDesi.)	<b>ITR4A15</b>	<b>5599</b>			TR55IX	7164	TR55GP	3403	TR55	3951	.060
<b>Express 2500</b>													
2018	V6 4.3L		ILTR5B11	3474	LTR5AHX	90220	LTR5IX-11	4344	LTR5GP	5019			.044
	V8 6.0L		IZTR5B11	1465	TR5AHX	94567	TR5IX	7397	TR5GP	3186	TR5	2238	.040
2017-12	V8 4.8L		IZTR5B11	1465	TR5AHX	94567	TR5IX	7397	TR5GP	3186	TR5	2238	.040
	V8 6.0L		IZTR5B11	1465	TR5AHX	94567	TR5IX	7397	TR5GP	3186	TR5	2238	.040
2011-07	V8 4.8L		IZTR5B11	1465	TR5AHX	94567	TR5IX	7397	TR5GP	3186	TR5	2238	.040
	V8 6.0L		IZTR5B11	1465	TR5AHX	94567	TR5IX	7397	TR5GP	3186	TR5	2238	.040
	V8 6.6L	DIESEL	Y1033AS	90046									
2006	V6 4.3L		<b>ITR4A15</b>	<b>5599</b>	TR5AHX	94567	TR55IX	7164	TR55GP	3403	TR55	3951	.060
	V8 4.8L		IZTR5B11	1465	TR5AHX	94567	TR5IX	7397	TR5GP	3186	TR5	2238	.040
	V8 6.0L		IZTR5B11	1465	TR5AHX	94567	TR5IX	7397	TR5GP	3186	TR5	2238	.040





Year	Cyl. L	Notes	Original Equipment		Ruthenium HX		Iridium IX		G-Power		V-Power		Gap
			Part	Stock	Part	Stock	Part	Stock	Part	Stock	Part	Stock	
<b>CHEVROLET (Cont'd)</b>													
<b>Express 2500 (Cont'd)</b>													
2006	V8 6.6L	DIESEL, w/ Hex Threads Located Middle of Glow Plug	Y1033AS	90046									
		DIESEL, w/ Hex Threads Located Near Top of Glow Plug (LLY Engine Only)	Y1032AS	97788									
2005-03	V6 4.3L		<b>ITR4A15</b>	<b>5599</b>	TR5AHX	94567	TR55IX	7164	TR55GP	3403	TR55	3951	.060
	V8 4.8L		IZTR5B11	1465	TR5AHX	94567	TR5IX	7397	TR5GP	3186	TR5	2238	.040
	V8 5.3L		IZTR5B11	1465	TR5AHX	94567	TR5IX	7397	TR5GP	3186	TR5	2238	.040
	V8 6.0L		IZTR5B11	1465	TR5AHX	94567	TR5IX	7397	TR5GP	3186	TR5	2238	.040
2002-97	V6 4.3L		<b>ITR4A15</b>	<b>5599</b>	TR5AHX	94567	TR55IX	7164	TR55GP	3403	TR55	3951	.060
	V8 5.0L		<b>ITR4A15</b>	<b>5599</b>	TR5AHX	94567	TR55IX	7164	TR55GP	3403	TR55	3951	.060
	V8 5.7L		<b>ITR4A15</b>	<b>5599</b>	TR5AHX	94567	TR55IX	7164	TR55GP	3403	TR55	3951	.060
1996	V6 4.3L		<b>ITR4A15</b>	<b>5599</b>			TR55IX	7164	TR55GP	3403	TR55	3951	.060
	V8 5.0L		<b>ITR4A15</b>	<b>5599</b>			TR55IX	7164	TR55GP	3403	TR55	3951	.060
	V8 5.7L	Vin R, Central SFI(FuelSystDesi.)	<b>ITR4A15</b>	<b>5599</b>			TR55IX	7164	TR55GP	3403	TR55	3951	.060
<b>Express 3500</b>													
2018	V6 4.3L		ILTR5B11	3474	LTR5AHX	90220	LTR5IX-11	4344	LTR5GP	5019			.044
	V8 6.0L		IZTR5B11	1465	TR5AHX	94567	TR5IX	7397	TR5GP	3186	TR5	2238	.040
2017-12	V8 4.8L		IZTR5B11	1465	TR5AHX	94567	TR5IX	7397	TR5GP	3186	TR5	2238	.040
	V8 6.0L		IZTR5B11	1465	TR5AHX	94567	TR5IX	7397	TR5GP	3186	TR5	2238	.040
2011-07	V8 4.8L		IZTR5B11	1465	TR5AHX	94567	TR5IX	7397	TR5GP	3186	TR5	2238	.040
	V8 6.0L		IZTR5B11	1465	TR5AHX	94567	TR5IX	7397	TR5GP	3186	TR5	2238	.040
2006	V8 6.6L	DIESEL	Y1033AS	90046									
	V8 4.8L		IZTR5B11	1465	TR5AHX	94567	TR5IX	7397	TR5GP	3186	TR5	2238	.040
	V8 6.0L		IZTR5B11	1465	TR5AHX	94567	TR5IX	7397	TR5GP	3186	TR5	2238	.040
2005-03	V8 4.8L		IZTR5B11	1465	TR5AHX	94567	TR5IX	7397	TR5GP	3186	TR5	2238	.040
	V8 6.0L		IZTR5B11	1465	TR5AHX	94567	TR5IX	7397	TR5GP	3186	TR5	2238	.040
2002-01	V8 5.7L		<b>ITR4A15</b>	<b>5599</b>	TR5AHX	94567	TR55IX	7164	TR55GP	3403	TR55	3951	.060
	V8 8.1L		PZTR5A-15	7862	TR5AHX	94567	TR55IX	7164	TR55GP	3403	TR55	3951	.060
2000-97	V8 5.7L		<b>ITR4A15</b>	<b>5599</b>	TR5AHX	94567	TR55IX	7164	TR55GP	3403	TR55	3951	.060
	V8 7.4L		PTR4G-15	1209	TR5AHX	94567	TR55IX	7164	TR55GP	3403	TR55	3951	.060
1996	V8 5.7L	Vin R, Central SFI(FuelSystDesi.)	<b>ITR4A15</b>	<b>5599</b>			TR55IX	7164	TR55GP	3403	TR55	3951	.060
	V8 7.4L	Vin J, SFI(FuelSystDesi.)	PTR4G-15	1209			TR55IX	7164	TR55GP	3403	TR55	3951	.060
<b>Express 4500</b>													
2018-12	V8 6.0L		IZTR5B11	1465	TR5AHX	94567	TR5IX	7397	TR5GP	3186	TR5	2238	.040
2011-09	V8 6.0L		IZTR5B11	1465	TR5AHX	94567	TR5IX	7397	TR5GP	3186	TR5	2238	.040
	V8 6.6L	DIESEL	Y1033AS	90046									
<b>G10</b>													
1995-94	V6 4.3L		UR5	2771			UR5IX	7177	UR5GP	3547	UR5	2771	.045
	V8 5.0L		UR5	2771			UR5IX	7177	UR5GP	3547	UR5	2771	.035
1993-87	V6 4.3L		UR5	2771			UR5IX	7177	UR5GP	3547	UR5	2771	.035
	V8 5.0L		UR5	2771			UR5IX	7177	UR5GP	3547	UR5	2771	.035
	V8 5.7L		UR5	2771			UR5IX	7177	UR5GP	3547	UR5	2771	.035
1986	V6 4.3L		UR5	2771			UR5IX	7177	UR5GP	3547	UR5	2771	.035
	V8 5.0L		UR5	2771			UR5IX	7177	UR5GP	3547	UR5	2771	.045
	V8 5.7L		UR5	2771			UR5IX	7177	UR5GP	3547	UR5	2771	.045
1985	V6 4.3L		UR5	2771			UR5IX	7177	UR5GP	3547	UR5	2771	.035
	V8 5.0L		UR5	2771			UR5IX	7177	UR5GP	3547	UR5	2771	.045

**Bold denotes NGK OE Manufacturer and/or OE Service Part**  
NOT BOLD denotes OE Equivalent Part

**Le texte en gras désigne une pièce d'équipement originale du manufacturier NGK et/ou pièce d'équipement originale de service**  
Le texte non en gras désigne une pièce d'équipement originale équivalente

Note: Due to different operating or engine conditions, alternate heat range plugs may be required.

Note: En raison de différences au niveau du fonctionnement ou des conditions du moteur, d'autres types de bougies avec variation de chaleur peuvent être nécessaires



Year	Cyl. L	Notes	Original Equipment		Ruthenium HX		Iridium IX		G-Power		V-Power		Gap
			Part	Stock	Part	Stock	Part	Stock	Part	Stock	Part	Stock	
<b>CHEVROLET (Cont'd)</b>													
<b>G10 (Cont'd)</b>													
1985	V8 5.7L	Vin L	UR5	2771			UR5IX	7177	UR5GP	3547	UR5	2771	.035
<b>G20</b>													
1995-94	V6 4.3L		UR5	2771			UR5IX	7177	UR5GP	3547	UR5	2771	.045
	V8 5.0L		UR5	2771			UR5IX	7177	UR5GP	3547	UR5	2771	.035
	V8 5.7L		UR5	2771			UR5IX	7177	UR5GP	3547	UR5	2771	.035
1993-87	V6 4.3L		UR5	2771			UR5IX	7177	UR5GP	3547	UR5	2771	.035
	V8 5.0L		UR5	2771			UR5IX	7177	UR5GP	3547	UR5	2771	.035
	V8 5.7L		UR5	2771			UR5IX	7177	UR5GP	3547	UR5	2771	.035
1986	V6 4.3L		UR5	2771			UR5IX	7177	UR5GP	3547	UR5	2771	.035
	V8 5.0L		UR5	2771			UR5IX	7177	UR5GP	3547	UR5	2771	.045
	V8 5.7L	Vin L	UR5	2771			UR5IX	7177	UR5GP	3547	UR5	2771	.045
		Vin M	YR5	7052			YR5IX	7516	YR5GP	2953	YR5	7052	.045
1985	V6 4.3L		UR5	2771			UR5IX	7177	UR5GP	3547	UR5	2771	.035
	V8 5.0L		UR5	2771			UR5IX	7177	UR5GP	3547	UR5	2771	.045
	V8 5.7L	Vin L	UR5	2771			UR5IX	7177	UR5GP	3547	UR5	2771	.035
		Vin M	YR5	7052			YR5IX	7516	YR5GP	2953	YR5	7052	.045
<b>G30</b>													
1996	V6 4.3L		UR5	2771			UR5IX	7177	UR5GP	3547	UR5	2771	.045
	V8 5.7L	Vin K, TBI(FuelSystDesi.)	UR5	2771			UR5IX	7177	UR5GP	3547	UR5	2771	.035
		V8 7.4L	Vin N, TBI(FuelSystDesi.)	UR5	2771			UR5IX	7177	UR5GP	3547	UR5	2771
1995	V6 4.3L		UR5	2771			UR5IX	7177	UR5GP	3547	UR5	2771	.045
	V8 5.7L	CNG	PTR4G-15	1209			TR55IX	7164	TR55GP	3403	TR55	3951	.060
		GAS	UR5	2771			UR5IX	7177	UR5GP	3547	UR5	2771	.035
V8 7.4L		UR5	2771			UR5IX	7177	UR5GP	3547	UR5	2771	.035	
1994	V6 4.3L		UR5	2771			UR5IX	7177	UR5GP	3547	UR5	2771	.045
	V8 5.7L		UR5	2771			UR5IX	7177	UR5GP	3547	UR5	2771	.035
	V8 7.4L		UR5	2771			UR5IX	7177	UR5GP	3547	UR5	2771	.035
1993-89	V6 4.3L		UR5	2771			UR5IX	7177	UR5GP	3547	UR5	2771	.035
	V8 5.7L		UR5	2771			UR5IX	7177	UR5GP	3547	UR5	2771	.035
	V8 7.4L		UR5	2771			UR5IX	7177	UR5GP	3547	UR5	2771	.035
1988	V6 4.3L		UR5	2771			UR5IX	7177	UR5GP	3547	UR5	2771	.035
	V8 5.7L	CARB	YR5	7052			YR5IX	7516	YR5GP	2953	YR5	7052	.045
		FI	UR5	2771			UR5IX	7177	UR5GP	3547	UR5	2771	.035
	V8 7.4L		UR5	2771			UR5IX	7177	UR5GP	3547	UR5	2771	.035
1987	V6 4.3L		UR5	2771			UR5IX	7177	UR5GP	3547	UR5	2771	.035
	V8 5.7L	CARB	YR5	7052			YR5IX	7516	YR5GP	2953	YR5	7052	.045
		FI	UR5	2771			UR5IX	7177	UR5GP	3547	UR5	2771	.035
1986	V6 4.3L		UR5	2771			UR5IX	7177	UR5GP	3547	UR5	2771	.035
	V8 5.7L	Vin L	UR5	2771			UR5IX	7177	UR5GP	3547	UR5	2771	.045
		Vin M	YR5	7052			YR5IX	7516	YR5GP	2953	YR5	7052	.045
1985	V6 4.3L		UR5	2771			UR5IX	7177	UR5GP	3547	UR5	2771	.035
	V8 5.0L		UR5	2771			UR5IX	7177	UR5GP	3547	UR5	2771	.045
	V8 5.7L	Vin L	UR5	2771			UR5IX	7177	UR5GP	3547	UR5	2771	.035
		Vin M	YR5	7052			YR5IX	7516	YR5GP	2953	YR5	7052	.045
<b>HHR</b>													
2011	L4 2.2L		<b>ILTR5E11</b>	<b>91418</b>	LTR5AHX	90220	LTR5IX-11	4344	LTR5GP	5019			.044
	L4 2.4L		<b>ILTR5E11</b>	<b>91418</b>	LTR5AHX	90220	LTR5IX-11	4344	LTR5GP	5019			.044
2010-09	L4 2.0L		<b>ILTR5D</b>	<b>5476</b>			LTR5IX-11	4344	LTR5GP	5019			.036
	L4 2.2L		<b>ILTR5E11</b>	<b>91418</b>	LTR5AHX	90220	LTR5IX-11	4344	LTR5GP	5019			.044
	L4 2.4L		<b>ILTR5E11</b>	<b>91418</b>	LTR5AHX	90220	LTR5IX-11	4344	LTR5GP	5019			.044
2008	L4 2.0L		<b>ILTR5D</b>	<b>5476</b>			LTR5IX-11	4344	LTR5GP	5019			.036
	L4 2.2L		<b>ILTR5B11</b>	<b>3474</b>	LTR5AHX	90220	LTR5IX-11	4344	LTR5GP	5019			.044
	L4 2.4L		<b>ILTR5B11</b>	<b>3474</b>	LTR5AHX	90220	LTR5IX-11	4344	LTR5GP	5019			.044
2007	L4 2.2L		<b>ILTR5B11</b>	<b>3474</b>	LTR5AHX	90220	LTR5IX-11	4344	LTR5GP	5019			.044
	L4 2.4L		<b>ILTR5B11</b>	<b>3474</b>	LTR5AHX	90220	LTR5IX-11	4344	LTR5GP	5019			.044
2006	L4 2.2L		<b>ILTR5B11</b>	<b>3474</b>			LTR5IX-11	4344	LTR5GP	5019			.044



Year	Cyl. L	Notes	Original Equipment		Ruthenium HX		Iridium IX		G-Power		V-Power		Gap
			Part	Stock	Part	Stock	Part	Stock	Part	Stock	Part	Stock	
<b>CHEVROLET (Cont'd)</b>													
<b>HHR (Cont'd)</b>													
2006	L4 2.4L		<b>ILTR5B11</b>	<b>3474</b>	LTR5AHX	90220	LTR5IX-11	4344	LTR5GP	5019			.044
<b>Impala</b>													
2018	L4 2.5L		<b>ILTR5L11</b>	<b>96329</b>	LTR5AHX	90220	LTR5IX-11	4344	LTR5GP	5019			.044
	V6 3.6L		<b>ILTR6E11</b>	<b>90117</b>	LTR6AHX	91276	LTR6IX-11	6509	LTR6GP	90198			.044
2017-15	L4 2.5L		<b>ILTR5L11</b>	<b>96329</b>	LTR5AHX	90220	LTR5IX-11	4344	LTR5GP	5019			.044
	V6 3.6L	FLEX, New Model	<b>ILTR6E11</b>	<b>90117</b>	LTR6AHX	91276	LTR6IX-11	6509	LTR6GP	90198			.044
2014	L4 2.4L		<b>ILTR5D</b>	<b>5476</b>	LTR5AHX	90220	LTR5IX-11	4344	LTR5GP	5019			.036
	L4 2.5L		<b>ILTR5L11</b>	<b>96329</b>	LTR5AHX	90220	LTR5IX-11	4344	LTR5GP	5019			.044
	V6 3.6L		<b>ILTR6E11</b>	<b>90117</b>	LTR6AHX	91276	LTR6IX-11	6509	LTR6GP	90198			.044
2013-12	V6 3.6L		<b>ILTR6E11</b>	<b>90117</b>	LTR6AHX	91276	LTR6IX-11	6509	LTR6GP	90198			.044
2011-10	V6 3.5L		<b>IZTR4A11</b>	<b>4213</b>			TR4IX	7300	TR4GP	2815	TR4	3754	.044
	V6 3.9L		<b>IZTR4A11</b>	<b>4213</b>			TR4IX	7300	TR4GP	2815	TR4	3754	.044
2009-06	V6 3.5L		<b>IZTR4A11</b>	<b>4213</b>			TR4IX	7300	TR4GP	2815	TR4	3754	.044
	V6 3.9L		<b>IZTR4A11</b>	<b>4213</b>			TR4IX	7300	TR4GP	2815	TR4	3754	.044
	V8 5.3L		IZTR5B11	1465	TR5AHX	94567	TR5IX	7397	TR5GP	3186	TR5	2238	.040
2005-03	V6 3.4L		<b>ITR4A15</b>	<b>5599</b>	TR4BHX	97100	TR55IX	7164	TR55GP	3403	TR55	3951	.060
	V6 3.8L		<b>ITR4A15</b>	<b>5599</b>	TR4BHX	97100	TR55IX	7164	TR55GP	3403	TR55	3951	.060
2002-00	V6 3.4L		ITR4A15	5599	TR4BHX	97100	TR55IX	7164	TR55GP	3403	TR55	3951	.060
	V6 3.8L		ITR4A15	5599	TR4BHX	97100	TR55IX	7164	TR55GP	3403	TR55	3951	.060
1996-94	V8 5.7L		PTR5F-11	6579			TR55IX	7164	TR55GP	3403	TR55	3951	.050
1985	V6 3.8L		UR45	6945			UR45IX	7559	UR45GP	3207	UR45	6945	.060
	V6 4.3L		UR4	6630			UR4IX	7401	UR4GP	2869	UR4	6630	.035
	V8 5.0L		UR4	6630			UR4IX	7401	UR4GP	2869	UR4	6630	.045
	V8 5.7L	GAS	UR4	6630			UR4IX	7401	UR4GP	2869	UR4	6630	.045
<b>Impala Limited</b>													
2016-15	V6 3.6L	FLEX, Carryover Model	<b>ILTR6E11</b>	<b>90117</b>	LTR6AHX	91276	LTR6IX-11	6509	LTR6GP	90198			.044
2014	V6 3.6L		<b>ILTR6E11</b>	<b>90117</b>	LTR6AHX	91276	LTR6IX-11	6509	LTR6GP	90198			.044
<b>K5 Blazer</b>													
1986-85	V8 5.0L		UR4	6630			UR4IX	7401	UR4GP	2869	UR4	6630	.045
	V8 5.7L		UR5	2771			UR5IX	7177	UR5GP	3547	UR5	2771	.045
<b>K10</b>													
1986-85	V6 4.3L		UR5	2771			UR5IX	7177	UR5GP	3547	UR5	2771	.035
	V8 5.0L		UR4	6630			UR4IX	7401	UR4GP	2869	UR4	6630	.045
	V8 5.7L	Vin L	UR5	2771			UR5IX	7177	UR5GP	3547	UR5	2771	.045
		Vin M	YR5	7052			YR5IX	7516	YR5GP	2953	YR5	7052	.045
<b>K10 Suburban</b>													
1986	V8 5.0L		UR4	6630			UR4IX	7401	UR4GP	2869	UR4	6630	.045
	V8 5.7L	Vin L	UR5	2771			UR5IX	7177	UR5GP	3547	UR5	2771	.045
		Vin M	YR5	7052			YR5IX	7516	YR5GP	2953	YR5	7052	.045
1985	V8 5.0L	Vin F	UR5	2771			UR5IX	7177	UR5GP	3547	UR5	2771	.045
		Vin H	UR4	6630			UR4IX	7401	UR4GP	2869	UR4	6630	.045
	V8 5.7L	Vin L	UR5	2771			UR5IX	7177	UR5GP	3547	UR5	2771	.045
Vin M		YR5	7052			YR5IX	7516	YR5GP	2953	YR5	7052	.045	
<b>K20</b>													
1986	L6 4.8L		YR5	7052			YR5IX	7516	YR5GP	2953	YR5	7052	.035
	V8 5.7L	Vin L	UR5	2771			UR5IX	7177	UR5GP	3547	UR5	2771	.045
		Vin M	YR5	7052			YR5IX	7516	YR5GP	2953	YR5	7052	.045
1985	L6 4.8L		YR5	7052			YR5IX	7516	YR5GP	2953	YR5	7052	.035
	V6 4.3L		UR5	2771			UR5IX	7177	UR5GP	3547	UR5	2771	.035
	V8 5.0L		UR4	6630			UR4IX	7401	UR4GP	2869	UR4	6630	.045
	V8 5.7L	Vin L	UR5	2771			UR5IX	7177	UR5GP	3547	UR5	2771	.045
		Vin M	YR5	7052			YR5IX	7516	YR5GP	2953	YR5	7052	.045
<b>K20 Suburban</b>													
1986	V8 5.0L		UR4	6630			UR4IX	7401	UR4GP	2869	UR4	6630	.035
	V8 5.7L	Vin L	UR5	2771			UR5IX	7177	UR5GP	3547	UR5	2771	.045
		Vin M	YR5	7052			YR5IX	7516	YR5GP	2953	YR5	7052	.045

**Bold denotes NGK OE Manufacturer and/or OE Service Part**  
NOT BOLD denotes OE Equivalent Part

**Le texte en gras désigne une pièce d'équipement originale du manufacturier NGK et/ou pièce d'équipement de service**  
Le texte non en gras désigne une pièce d'équipement originale équivalente

Note: Due to different operating or engine conditions, alternate heat range plugs may be required.

Note: En raison de différences au niveau du fonctionnement ou des conditions du moteur, d'autres types de bougies avec variation de chaleur peuvent être nécessaires



Year	Cyl. L	Notes	Original Equipment		Ruthenium HX		Iridium IX		G-Power		V-Power		Gap
			Part	Stock	Part	Stock	Part	Stock	Part	Stock	Part	Stock	
<b>CHEVROLET (Cont'd)</b>													
<b>K20 Suburban (Cont'd)</b>													
1985	V8 5.0L		UR4	6630			UR4IX	7401	UR4GP	2869	UR4	6630	.035
	V8 5.7L	Vin L	UR5	2771			UR5IX	7177	UR5GP	3547	UR5	2771	.045
		Vin M	YR5	7052			YR5IX	7516	YR5GP	2953	YR5	7052	.045
	V8 7.4L		YR5	7052			YR5IX	7516	YR5GP	2953	YR5	7052	.045
<b>K30</b>													
1986	L6 4.8L		YR5	7052			YR5IX	7516	YR5GP	2953	YR5	7052	.035
	V8 5.7L		YR5	7052			YR5IX	7516	YR5GP	2953	YR5	7052	.045
	V8 7.4L		YR5	7052			YR5IX	7516	YR5GP	2953	YR5	7052	.045
1985	L6 4.8L		YR5	7052			YR5IX	7516	YR5GP	2953	YR5	7052	.035
	V8 5.7L	Vin L	UR5	2771			UR5IX	7177	UR5GP	3547	UR5	2771	.045
		Vin M	YR5	7052			YR5IX	7516	YR5GP	2953	YR5	7052	.045
	V8 7.4L		YR5	7052			YR5IX	7516	YR5GP	2953	YR5	7052	.045
<b>K1500</b>													
1999	V8 5.0L		<b>ITR4A15</b>	<b>5599</b>	TR5AHX	94567	TR55IX	7164	TR55GP	3403	TR55	3951	.060
	V8 5.7L		<b>ITR4A15</b>	<b>5599</b>	TR5AHX	94567	TR55IX	7164	TR55GP	3403	TR55	3951	.060
1998-97	V6 4.3L		<b>ITR4A15</b>	<b>5599</b>	TR5AHX	94567	TR55IX	7164	TR55GP	3403	TR55	3951	.060
	V8 5.0L		<b>ITR4A15</b>	<b>5599</b>	TR5AHX	94567	TR55IX	7164	TR55GP	3403	TR55	3951	.060
	V8 5.7L		<b>ITR4A15</b>	<b>5599</b>	TR5AHX	94567	TR55IX	7164	TR55GP	3403	TR55	3951	.060
1996	V6 4.3L		<b>ITR4A15</b>	<b>5599</b>			TR55IX	7164	TR55GP	3403	TR55	3951	.060
	V8 5.0L		<b>ITR4A15</b>	<b>5599</b>			TR55IX	7164	TR55GP	3403	TR55	3951	.060
	V8 5.7L		<b>ITR4A15</b>	<b>5599</b>			TR55IX	7164	TR55GP	3403	TR55	3951	.060
1995-94	V6 4.3L		UR5	2771			UR5IX	7177	UR5GP	3547	UR5	2771	.045
	V8 5.0L		UR5	2771			UR5IX	7177	UR5GP	3547	UR5	2771	.035
	V8 5.7L		UR5	2771			UR5IX	7177	UR5GP	3547	UR5	2771	.035
1993-88	V6 4.3L		UR5	2771			UR5IX	7177	UR5GP	3547	UR5	2771	.035
	V8 5.0L		UR5	2771			UR5IX	7177	UR5GP	3547	UR5	2771	.035
	V8 5.7L		UR5	2771			UR5IX	7177	UR5GP	3547	UR5	2771	.035
<b>K1500 Suburban</b>													
1999-97	V8 5.7L		<b>ITR4A15</b>	<b>5599</b>	TR5AHX	94567	TR55IX	7164	TR55GP	3403	TR55	3951	.060
1996	V8 5.7L		<b>ITR4A15</b>	<b>5599</b>			TR55IX	7164	TR55GP	3403	TR55	3951	.060
1995-92	V8 5.7L		UR5	2771			UR5IX	7177	UR5GP	3547	UR5	2771	.035
<b>K2500</b>													
2000-99	V8 5.7L		<b>ITR4A15</b>	<b>5599</b>	TR5AHX	94567	TR55IX	7164	TR55GP	3403	TR55	3951	.060
	V8 7.4L		PTR4G-15	1209	TR5AHX	94567	TR55IX	7164	TR55GP	3403	TR55	3951	.060
1998-97	V8 5.0L		<b>ITR4A15</b>	<b>5599</b>	TR5AHX	94567	TR55IX	7164	TR55GP	3403	TR55	3951	.060
	V8 5.7L		<b>ITR4A15</b>	<b>5599</b>	TR5AHX	94567	TR55IX	7164	TR55GP	3403	TR55	3951	.060
	V8 7.4L		PTR4G-15	1209	TR5AHX	94567	TR55IX	7164	TR55GP	3403	TR55	3951	.060
	V8 5.7L		<b>ITR4A15</b>	<b>5599</b>			TR55IX	7164	TR55GP	3403	TR55	3951	.060
1996	V8 5.7L		<b>ITR4A15</b>	<b>5599</b>			TR55IX	7164	TR55GP	3403	TR55	3951	.060
	V8 7.4L		PTR4G-15	1209			TR55IX	7164	TR55GP	3403	TR55	3951	.060
1995-94	V6 4.3L		UR5	2771			UR5IX	7177	UR5GP	3547	UR5	2771	.045
	V8 5.0L		UR5	2771			UR5IX	7177	UR5GP	3547	UR5	2771	.035
	V8 5.7L		UR5	2771			UR5IX	7177	UR5GP	3547	UR5	2771	.035
	V8 7.4L		UR5	2771			UR5IX	7177	UR5GP	3547	UR5	2771	.035
1993-92	V6 4.3L		UR5	2771			UR5IX	7177	UR5GP	3547	UR5	2771	.035
	V8 5.0L		UR5	2771			UR5IX	7177	UR5GP	3547	UR5	2771	.035
	V8 5.7L	CNG	PTR4G-15	1209			TR55IX	7164	TR55GP	3403	TR55	3951	.060
		GAS	UR5	2771			UR5IX	7177	UR5GP	3547	UR5	2771	.035
	V8 7.4L		UR5	2771			UR5IX	7177	UR5GP	3547	UR5	2771	.035
1991	V6 4.3L		UR5	2771			UR5IX	7177	UR5GP	3547	UR5	2771	.035
	V8 5.0L		UR5	2771			UR5IX	7177	UR5GP	3547	UR5	2771	.035
	V8 5.7L		UR5	2771			UR5IX	7177	UR5GP	3547	UR5	2771	.035
	V8 7.4L		UR5	2771			UR5IX	7177	UR5GP	3547	UR5	2771	.035
1990-88	V6 4.3L		UR5	2771			UR5IX	7177	UR5GP	3547	UR5	2771	.035
	V8 5.0L		UR5	2771			UR5IX	7177	UR5GP	3547	UR5	2771	.035
	V8 5.7L		UR5	2771			UR5IX	7177	UR5GP	3547	UR5	2771	.035
<b>K2500 Suburban</b>													
1999-97	V8 5.7L		<b>ITR4A15</b>	<b>5599</b>	TR5AHX	94567	TR55IX	7164	TR55GP	3403	TR55	3951	.060



Year	Cyl. L	Notes	Original Equipment		Ruthenium HX		Iridium IX		G-Power		V-Power		Gap
			Part	Stock	Part	Stock	Part	Stock	Part	Stock	Part	Stock	
<b>CHEVROLET (Cont'd)</b>													
<b>K2500 Suburban (Cont'd)</b>													
1999-97	V8 7.4L		PTR4G-15	1209	TR5AHX	94567	TR55IX	7164	TR55GP	3403	TR55	3951	.060
1996	V8 5.7L		<b>ITR4A15</b>	<b>5599</b>			TR55IX	7164	TR55GP	3403	TR55	3951	.060
	V8 7.4L		PTR4G-15	1209			TR55IX	7164	TR55GP	3403	TR55	3951	.060
1995-92	V8 5.7L		UR5	2771			UR5IX	7177	UR5GP	3547	UR5	2771	.035
	V8 7.4L		UR5	2771			UR5IX	7177	UR5GP	3547	UR5	2771	.035
<b>K3500</b>													
2000-97	V8 5.7L		<b>ITR4A15</b>	<b>5599</b>	TR5AHX	94567	TR55IX	7164	TR55GP	3403	TR55	3951	.060
	V8 7.4L		PTR4G-15	1209	TR5AHX	94567	TR55IX	7164	TR55GP	3403	TR55	3951	.060
1996	V8 5.7L		<b>ITR4A15</b>	<b>5599</b>			TR55IX	7164	TR55GP	3403	TR55	3951	.060
	V8 7.4L		PTR4G-15	1209			TR55IX	7164	TR55GP	3403	TR55	3951	.060
1995-88	V8 5.7L		UR5	2771			UR5IX	7177	UR5GP	3547	UR5	2771	.035
	V8 7.4L		UR5	2771			UR5IX	7177	UR5GP	3547	UR5	2771	.035
<b>LLV</b>													
1995-94	L4 2.2L		PZTR5A-15	7862			TR55-1IX	7316	TR55-1GP	7159	TR55-1	2683	.060
1993-87	L4 2.5L		UR55	2248			UR55IX	7272			UR55	2248	.060
<b>Lumina</b>													
2001-00	V6 3.1L		ITR4A15	5599	TR4BHX	97100	TR55IX	7164	TR55GP	3403	TR55	3951	.060
1999-98	V6 3.1L		ITR4A15	5599	TR4BHX	97100	TR55IX	7164	TR55GP	3403	TR55	3951	.060
	V6 3.8L		ITR4A15	5599	TR4BHX	97100	TR55IX	7164	TR55GP	3403	TR55	3951	.060
1997	V6 3.1L		ITR4A15	5599	TR4BHX	97100	TR55IX	7164	TR55GP	3403	TR55	3951	.060
	V6 3.4L		<b>ITR4A15</b>	<b>5599</b>	TR4BHX	97100	TR55IX	7164	TR55GP	3403	TR55	3951	.060
1996	V6 3.1L		ITR4A15	5599			TR55IX	7164	TR55GP	3403	TR55	3951	.060
	V6 3.4L		<b>ITR4A15</b>	<b>5599</b>			TR55IX	7164	TR55GP	3403	TR55	3951	.060
1995	V6 3.1L		TR55	3951			TR55IX	7164	TR55GP	3403	TR55	3951	.060
	V6 3.4L		<b>ITR4A15</b>	<b>5599</b>			TR55IX	7164	TR55GP	3403	TR55	3951	.060
1994	V6 3.1L		TR4	3754			TR4IX	7300	TR4GP	2815	TR4	3754	.045
	V6 3.4L		TR5	2238			TR5IX	7397	TR5GP	3186	TR5	2238	.045
1993	L4 2.2L		TR4	3754			TR4IX	7300	TR4GP	2815	TR4	3754	.045
	V6 3.1L		TR4	3754			TR4IX	7300	TR4GP	2815	TR4	3754	.045
	V6 3.4L		TR5	2238			TR5IX	7397	TR5GP	3186	TR5	2238	.045
1992-91	L4 2.5L		UR55	2248			UR55IX	7272			UR55	2248	.060
	V6 3.1L		TR4	3754			TR4IX	7300	TR4GP	2815	TR4	3754	.045
	V6 3.4L		TR5	2238			TR5IX	7397	TR5GP	3186	TR5	2238	.045
1990	L4 2.5L		UR55	2248			UR55IX	7272			UR55	2248	.060
	V6 3.1L		TR4	3754			TR4IX	7300	TR4GP	2815	TR4	3754	.045
<b>Lumina APV</b>													
1996	V6 3.4L		ITR4A15	5599			TR55IX	7164	TR55GP	3403	TR55	3951	.060
1995-94	V6 3.1L		UR5	2771			UR5IX	7177	UR5GP	3547	UR5	2771	.045
	V6 3.8L		ITR4A15	5599			TR55IX	7164	TR55GP	3403	TR55	3951	.060
1993-92	V6 3.1L		UR5	2771			UR5IX	7177	UR5GP	3547	UR5	2771	.045
	V6 3.8L		TR55	3951			TR55IX	7164	TR55GP	3403	TR55	3951	.060
1991-90	V6 3.1L		UR5	2771			UR5IX	7177	UR5GP	3547	UR5	2771	.045
<b>Malibu</b>													
2018-16	L4 1.5L		ILNAR8B7G	91970									.028
	L4 1.8L		<b>SILNAR7B7</b>	<b>93227</b>									.030
	L4 2.0L		<b>ILTR6M9G</b>	<b>94489</b>	LTR6BHX	90495							.036
2015	L4 2.0L		<b>ILTR6M9G</b>	<b>94489</b>	LTR6BHX	90495							.036
	L4 2.5L		<b>ILTR5L11</b>	<b>96329</b>	LTR5AHX	90220	LTR5IX-11	4344	LTR5GP	5019			.044
2014	L4 2.0L		<b>ILTR6M9G</b>	<b>94489</b>	LTR6BHX	90495							.036
	L4 2.4L		<b>ILTR5D</b>	<b>5476</b>	LTR5AHX	90220	LTR5IX-11	4344	LTR5GP	5019			.036
	L4 2.5L		<b>ILTR5L11</b>	<b>96329</b>	LTR5AHX	90220	LTR5IX-11	4344	LTR5GP	5019			.044
2013	L4 2.0L		<b>ILTR5M9G</b>	<b>90882</b>			LTR5IX-11	4344	LTR5GP	5019			.036
	L4 2.4L		<b>ILTR5D</b>	<b>5476</b>	LTR5AHX	90220	LTR5IX-11	4344	LTR5GP	5019			.036
	L4 2.5L		<b>ILTR5L11</b>	<b>96329</b>	LTR5AHX	90220	LTR5IX-11	4344	LTR5GP	5019			.044
2012-11	L4 2.4L		<b>ILTR5E11</b>	<b>91418</b>	LTR5AHX	90220	LTR5IX-11	4344	LTR5GP	5019			.044
	V6 3.6L		<b>ILTR6E11</b>	<b>90117</b>	LTR6AHX	91276	LTR6IX-11	6509	LTR6GP	90198			.044
2010-09	L4 2.4L		<b>ILTR5E11</b>	<b>91418</b>	LTR5AHX	90220	LTR5IX-11	4344	LTR5GP	5019			.044

**Bold denotes NGK OE Manufacturer and/or OE Service Part**  
NOT BOLD denotes OE Equivalent Part

**Le texte en gras désigne une pièce d'équipement originale du manufacturier NGK et/ou pièce d'équipement originale de service**  
Le texte non en gras désigne une pièce d'équipement originale équivalente

Note: Due to different operating or engine conditions, alternate heat range plugs may be required.

Note: En raison de différences au niveau du fonctionnement ou des conditions du moteur, d'autres types de bougies avec variation de chaleur peuvent être nécessaires





Year	Cyl. L	Notes	Original Equipment		Ruthenium HX		Iridium IX		G-Power		V-Power		Gap
			Part	Stock	Part	Stock	Part	Stock	Part	Stock	Part	Stock	
<b>CHEVROLET (Cont'd)</b>													
<b>Malibu (Cont'd)</b>													
2010-09	V6 3.5L		<b>IZTR4A11</b>	<b>4213</b>			TR4IX	7300	TR4GP	2815	TR4		.044
	V6 3.6L		PLTR6A-10G	3587	LTR6AHX	91276	LTR6IX-11	6509	LTR6GP	90198			.044
2008	L4 2.2L		<b>ILTR5B11</b>	<b>3474</b>	LTR5AHX	90220	LTR5IX-11	4344	LTR5GP	5019			.044
	L4 2.4L		<b>ILTR5B11</b>	<b>3474</b>	LTR5AHX	90220	LTR5IX-11	4344	LTR5GP	5019			.044
	V6 3.5L		<b>IZTR4A11</b>	<b>4213</b>			TR4IX	7300	TR4GP	2815	TR4	3754	.044
	V6 3.6L		PLTR6A-10G	3587	LTR6AHX	91276	LTR6IX-11	6509	LTR6GP	90198			.044
2007	L4 2.2L		<b>ILTR5B11</b>	<b>3474</b>	LTR5AHX	90220	LTR5IX-11	4344	LTR5GP	5019			.044
	V6 3.5L		<b>IZTR4A11</b>	<b>4213</b>			TR4IX	7300	TR4GP	2815	TR4	3754	.044
	V6 3.9L		<b>IZTR4A11</b>	<b>4213</b>			TR4IX	7300	TR4GP	2815	TR4	3754	.044
2006	L4 2.2L		<b>ILTR5C11</b>	<b>5581</b>			LTR5IX-11	4344	LTR5GP	5019			.044
	V6 3.5L		<b>ITR4A15</b>	<b>5599</b>	TR4BHX	97100	TR55IX	7164	TR55GP	3403	TR55	3951	.060
	V6 3.9L		<b>IZTR4A11</b>	<b>4213</b>			TR4IX	7300	TR4GP	2815	TR4	3754	.044
2005-04	L4 2.2L		<b>ILTR5C11</b>	<b>5581</b>			LTR5IX-11	4344	LTR5GP	5019			.044
	V6 3.5L		<b>ITR4A15</b>	<b>5599</b>	TR4BHX	97100	TR55IX	7164	TR55GP	3403	TR55	3951	.060
2003	V6 3.1L		<b>ITR4A15</b>	<b>5599</b>	TR4BHX	97100	TR55IX	7164	TR55GP	3403	TR55	3951	.060
2002-00	V6 3.1L		ITR4A15	5599	TR4BHX	97100	TR55IX	7164	TR55GP	3403	TR55	3951	.060
1999	L4 2.4L		PTR5F-11	6579	TR5AHX	94567	TR55IX	7164	TR55GP	3403	TR55	3951	.050
	V6 3.1L		ITR4A15	5599	TR4BHX	97100	TR55IX	7164	TR55GP	3403	TR55	3951	.060
1998-97	L4 2.4L		PZTR5A-15	7862	TR5AHX	94567	TR55IX	7164	TR55GP	3403	TR55	3951	.060
	V6 3.1L		ITR4A15	5599	TR4BHX	97100	TR55IX	7164	TR55GP	3403	TR55	3951	.060
<b>Malibu Limited</b>													
2016	L4 2.5L		<b>ILTR5L11</b>	<b>96329</b>	LTR5AHX	90220	LTR5IX-11	4344	LTR5GP	5019			.044
<b>Metro</b>													
2001	L4 1.3L		<b>BKR6E-11</b>	<b>2756</b>	FR6BHX-S	95159	BKR6EIX-11	3764	BKR6EGP	7092	BKR6E-11	2756	.042
2000-98	L3 1.0L		<b>BPR6ES-11</b>	<b>7133</b>			BPR6EIX-11	3903	BPR6EGP	7084	BPR6EY-11	6261	.042
	L4 1.3L		<b>BKR6E-11</b>	<b>2756</b>	FR6BHX-S	95159	BKR6EIX-11	3764	BKR6EGP	7092	BKR6E-11	2756	.042
1992	L4 1.3L		<b>BPR6ES-11</b>	<b>7133</b>			BPR6EIX-11	3903	BPR6EGP	7084	BPR6EY-11	6261	.042
<b>Monte Carlo</b>													
2007-06	V6 3.5L		<b>IZTR4A11</b>	<b>4213</b>			TR4IX	7300	TR4GP	2815	TR4	3754	.044
	V6 3.9L		<b>IZTR4A11</b>	<b>4213</b>			TR4IX	7300	TR4GP	2815	TR4	3754	.044
	V8 5.3L		IZTR5B11	1465	TR5AHX	94567	TR5IX	7397	TR5GP	3186	TR5	2238	.040
2005-03	V6 3.4L		<b>ITR4A15</b>	<b>5599</b>	TR4BHX	97100	TR55IX	7164	TR55GP	3403	TR55	3951	.060
	V6 3.8L		<b>ITR4A15</b>	<b>5599</b>	TR4BHX	97100	TR55IX	7164	TR55GP	3403	TR55	3951	.060
2002-00	V6 3.4L		ITR4A15	5599	TR4BHX	97100	TR55IX	7164	TR55GP	3403	TR55	3951	.060
	V6 3.8L		ITR4A15	5599	TR4BHX	97100	TR55IX	7164	TR55GP	3403	TR55	3951	.060
1999-98	V6 3.1L		ITR4A15	5599	TR4BHX	97100	TR55IX	7164	TR55GP	3403	TR55	3951	.060
	V6 3.8L		ITR4A15	5599	TR4BHX	97100	TR55IX	7164	TR55GP	3403	TR55	3951	.060
1997	V6 3.1L		ITR4A15	5599	TR4BHX	97100	TR55IX	7164	TR55GP	3403	TR55	3951	.060
	V6 3.4L		<b>ITR4A15</b>	<b>5599</b>	TR4BHX	97100	TR55IX	7164	TR55GP	3403	TR55	3951	.060
1996	V6 3.1L		ITR4A15	5599			TR55IX	7164	TR55GP	3403	TR55	3951	.060
	V6 3.4L		<b>ITR4A15</b>	<b>5599</b>			TR55IX	7164	TR55GP	3403	TR55	3951	.060
1995	V6 3.1L		TR55	3951			TR55IX	7164	TR55GP	3403	TR55	3951	.060
	V6 3.4L		<b>ITR4A15</b>	<b>5599</b>			TR55IX	7164	TR55GP	3403	TR55	3951	.060
1988	V6 4.3L		UR4	6630			UR4IX	7401	UR4GP	2869	UR4	6630	.035
	V8 5.0L		UR4	6630			UR4IX	7401	UR4GP	2869	UR4	6630	.035
1987	V6 3.8L		UR45	6945			UR45IX	7559	UR45GP	3207	UR45	6945	.060
	V6 4.3L		UR4	6630			UR4IX	7401	UR4GP	2869	UR4	6630	.035
	V8 5.0L		UR4	6630			UR4IX	7401	UR4GP	2869	UR4	6630	.035
1986	V6 3.8L		UR45	6945			UR45IX	7559	UR45GP	3207	UR45	6945	.060
	V6 4.3L		UR4	6630			UR4IX	7401	UR4GP	2869	UR4	6630	.035
	V8 5.0L		UR5	2771			UR5IX	7177	UR5GP	3547	UR5	2771	.035
1985	V6 3.8L		UR45	6945			UR45IX	7559	UR45GP	3207	UR45	6945	.060
	V6 4.3L		UR4	6630			UR4IX	7401	UR4GP	2869	UR4	6630	.035
	V8 5.0L	Vin G	UR5	2771			UR5IX	7177	UR5GP	3547	UR5	2771	.045
		Vin H	UR4	6630			UR4IX	7401	UR4GP	2869	UR4	6630	.045
<b>Nova</b>													
1988	L4 1.6L	CARB	<b>BPR5EY-11</b>	<b>6937</b>			BPR5EIX-11	2115	BPR5EGP	7082	BPR5EY-11	6937	.044



Year	Cyl. L	Notes	Original Equipment		Ruthenium HX		Iridium IX		G-Power		V-Power		Gap
			Part	Stock	Part	Stock	Part	Stock	Part	Stock	Part	Stock	
<b>CHEVROLET (Cont'd)</b>													
Nova (Cont'd)													
1988		FI	<b>BCPR5EP-11</b>	<b>2097</b>			BCPR5EIX-11	3306	BCPR5EGP	7086	BCPR5EY-11	2441	.044
1987-85	L4 1.6L		<b>BPR5EY-11</b>	<b>6937</b>			BPR5EIX-11	2115	BPR5EGP	7082	BPR5EY-11	6937	.044
Optra													
2007-05	L4 2.0L		BKR6EK	2288	FR6BHX-S	95159	BKR6EIX	6418	BKR6EGP	7092	BKR6E	6962	.039
2004	L4 2.0L		<b>BKUR6ETB</b>	<b>6992</b>	FR6BHX-S	95159							.032
Orlando													
2014-12	L4 2.4L		<b>ILTR5D</b>	<b>5476</b>	LTR5AHX	90220	LTR5IX-11	4344	LTR5GP	5019			.036
P20													
1989-88	L6 4.8L		YR5	7052			YR5IX	7516	YR5GP	2953	YR5	7052	.035
	V8 5.7L		UR5	2771			UR5IX	7177	UR5GP	3547	UR5	2771	.035
1987	L6 4.8L		YR5	7052			YR5IX	7516	YR5GP	2953	YR5	7052	.035
	V8 5.7L	CARB	YR5	7052			YR5IX	7516	YR5GP	2953	YR5	7052	.045
		FI	UR5	2771			UR5IX	7177	UR5GP	3547	UR5	2771	.035
1986-85	L6 4.8L		YR5	7052			YR5IX	7516	YR5GP	2953	YR5	7052	.035
	V8 5.7L		YR5	7052			YR5IX	7516	YR5GP	2953	YR5	7052	.045
P30													
1999-98	V6 4.3L		<b>ITR4A15</b>	<b>5599</b>	TR5AHX	94567	TR55IX	7164	TR55GP	3403	TR55	3951	.060
	V8 5.7L		<b>ITR4A15</b>	<b>5599</b>	TR5AHX	94567	TR55IX	7164	TR55GP	3403	TR55	3951	.060
	V8 7.4L	Vin B, MPI(FuelSystDesi.)	<b>ITR4A15</b>	<b>5599</b>	TR5AHX	94567	TR55IX	7164	TR55GP	3403	TR55	3951	.060
		Vin J, SFI(FuelSystDesi.)	PTR4G-15	1209	TR5AHX	94567	TR55IX	7164	TR55GP	3403	TR55	3951	.060
1997	V6 4.3L		PZTR5A-15	7862	TR5AHX	94567	TR55IX	7164	TR55GP	3403	TR55	3951	.060
	V8 5.7L		<b>ITR4A15</b>	<b>5599</b>	TR5AHX	94567	TR55IX	7164	TR55GP	3403	TR55	3951	.060
	V8 7.4L	Vin J, SFI(FuelSystDesi.)	PTR4G-15	1209	TR5AHX	94567	TR55IX	7164	TR55GP	3403	TR55	3951	.060
		Vin N, TBI(FuelSystDesi.)	UR5	2771			UR5IX	7177	UR5GP	3547	UR5	2771	.035
1996	V6 4.3L		PZTR5A-15	7862			TR55IX	7164	TR55GP	3403	TR55	3951	.060
	V8 5.7L	Vin K, TBI(FuelSystDesi.)	UR5	2771			UR5IX	7177	UR5GP	3547	UR5	2771	.035
	V8 7.4L	Vin J, SFI(FuelSystDesi.)	PTR4G-15	1209			TR55IX	7164	TR55GP	3403	TR55	3951	.060
		Vin N, TBI(FuelSystDesi.)	UR5	2771			UR5IX	7177	UR5GP	3547	UR5	2771	.035
1995-94	V6 4.3L		UR5	2771			UR5IX	7177	UR5GP	3547	UR5	2771	.045
	V8 5.7L		UR5	2771			UR5IX	7177	UR5GP	3547	UR5	2771	.035
	V8 7.4L		UR5	2771			UR5IX	7177	UR5GP	3547	UR5	2771	.035
1993-90	V6 4.3L		UR5	2771			UR5IX	7177	UR5GP	3547	UR5	2771	.035
	V8 5.7L		UR5	2771			UR5IX	7177	UR5GP	3547	UR5	2771	.035
	V8 7.4L		UR5	2771			UR5IX	7177	UR5GP	3547	UR5	2771	.035
1989	L6 4.8L		YR5	7052			YR5IX	7516	YR5GP	2953	YR5	7052	.035
	V8 5.7L		UR5	2771			UR5IX	7177	UR5GP	3547	UR5	2771	.035
	V8 7.4L		YR5	7052			YR5IX	7516	YR5GP	2953	YR5	7052	.035
1988	L6 4.8L		YR5	7052			YR5IX	7516	YR5GP	2953	YR5	7052	.035
	V8 5.7L	CARB	YR5	7052			YR5IX	7516	YR5GP	2953	YR5	7052	.045
		FI	UR5	2771			UR5IX	7177	UR5GP	3547	UR5	2771	.035
	V8 7.4L		YR5	7052			YR5IX	7516	YR5GP	2953	YR5	7052	.035
1987	L6 4.8L		YR5	7052			YR5IX	7516	YR5GP	2953	YR5	7052	.035
	V8 5.7L	CARB	YR5	7052			YR5IX	7516	YR5GP	2953	YR5	7052	.045
		FI	UR5	2771			UR5IX	7177	UR5GP	3547	UR5	2771	.035
	V8 7.4L		YR5	7052			YR5IX	7516	YR5GP	2953	YR5	7052	.045
1986-85	L6 4.8L		YR5	7052			YR5IX	7516	YR5GP	2953	YR5	7052	.035
	V8 5.7L		YR5	7052			YR5IX	7516	YR5GP	2953	YR5	7052	.045
	V8 7.4L		YR5	7052			YR5IX	7516	YR5GP	2953	YR5	7052	.045
P40													
1988	V6 4.3L		UR5	2771			UR5IX	7177	UR5GP	3547	UR5	2771	.035
Prizm													
2002-00	L4 1.8L		<b>IFR5T11</b>	<b>4996</b>	FR5AHX	95839	BKR5EIX-11	5464	BKR5EGP	7090	BKR5E-11	6953	.044

**Bold denotes NGK OE Manufacturer and/or OE Service Part**  
NOT BOLD denotes OE Equivalent Part

**Le texte en gras désigne une pièce d'équipement originale du manufacturier NGK et/ou pièce d'équipement originale de service**  
Le texte non en gras désigne une pièce d'équipement originale équivalente

Note: Due to different operating or engine conditions, alternate heat range plugs may be required.

Note: En raison de différences au niveau du fonctionnement ou des conditions du moteur, d'autres types de bougies avec variation de chaleur peuvent être nécessaires



Year	Cyl. L	Notes	Original Equipment		Ruthenium HX		Iridium IX		G-Power		V-Power		Gap
			Part	Stock	Part	Stock	Part	Stock	Part	Stock	Part	Stock	
<b>CHEVROLET (Cont'd)</b>													
Prizm (Cont'd)													
1999-98	L4 1.8L		<b>BKR5EKB-11</b>	<b>3967</b>	FR5BHX	96457	BKR5EIX-11	5464	BKR5EGP	7090	BKR5E-11	6953	.044
<b>R10</b>													
1987	V6 4.3L		UR5	2771			UR5IX	7177	UR5GP	3547	UR5	2771	.035
	V8 5.0L		UR5	2771			UR5IX	7177	UR5GP	3547	UR5	2771	.035
	V8 5.7L		UR5	2771			UR5IX	7177	UR5GP	3547	UR5	2771	.035
<b>R10 Suburban</b>													
1988	V8 5.7L		UR5	2771			UR5IX	7177	UR5GP	3547	UR5	2771	.035
1987	V8 5.0L		UR5	2771			UR5IX	7177	UR5GP	3547	UR5	2771	.035
	V8 5.7L		UR5	2771			UR5IX	7177	UR5GP	3547	UR5	2771	.035
<b>R20</b>													
1988-87	L6 4.8L		YR5	7052			YR5IX	7516	YR5GP	2953	YR5	7052	.035
	V6 4.3L		UR5	2771			UR5IX	7177	UR5GP	3547	UR5	2771	.035
	V8 5.0L		UR5	2771			UR5IX	7177	UR5GP	3547	UR5	2771	.035
	V8 5.7L		UR5	2771			UR5IX	7177	UR5GP	3547	UR5	2771	.035
	V8 7.4L		UR5	2771			UR5IX	7177	UR5GP	3547	UR5	2771	.035
<b>R20 Suburban</b>													
1988-87	V8 5.7L		UR5	2771			UR5IX	7177	UR5GP	3547	UR5	2771	.035
	V8 7.4L		UR5	2771			UR5IX	7177	UR5GP	3547	UR5	2771	.035
<b>R30</b>													
1988-87	L6 4.8L		YR5	7052			YR5IX	7516	YR5GP	2953	YR5	7052	.035
	V8 5.7L	CARB	YR5	7052			YR5IX	7516	YR5GP	2953	YR5	7052	.035
		FI	UR5	2771			UR5IX	7177	UR5GP	3547	UR5	2771	.035
	V8 7.4L	CARB	YR5	7052			YR5IX	7516	YR5GP	2953	YR5	7052	.045
		FI	UR5	2771			UR5IX	7177	UR5GP	3547	UR5	2771	.035
<b>R1500 Suburban</b>													
1991-89	V8 5.7L		UR5	2771			UR5IX	7177	UR5GP	3547	UR5	2771	.035
<b>R2500</b>													
1989	V8 7.4L		UR5	2771			UR5IX	7177	UR5GP	3547	UR5	2771	.035
<b>R2500 Suburban</b>													
1991-89	V8 5.7L		UR5	2771			UR5IX	7177	UR5GP	3547	UR5	2771	.035
	V8 7.4L		UR5	2771			UR5IX	7177	UR5GP	3547	UR5	2771	.035
<b>R3500</b>													
1991-90	V8 5.7L		UR5	2771			UR5IX	7177	UR5GP	3547	UR5	2771	.035
	V8 7.4L		UR5	2771			UR5IX	7177	UR5GP	3547	UR5	2771	.035
1989	V8 5.7L		UR5	2771			UR5IX	7177	UR5GP	3547	UR5	2771	.035
	V8 7.4L	CARB	YR5	7052			YR5IX	7516	YR5GP	2953	YR5	7052	.045
FI		UR5	2771			UR5IX	7177	UR5GP	3547	UR5	2771	.035	
<b>S10</b>													
2004	V6 4.3L		<b>ITR4A15</b>	<b>5599</b>	TR5AHX	94567	TR55IX	7164	TR55GP	3403	TR55	3951	.060
2003-98	L4 2.2L		PTR5D-10	3784			TR5IX	7397	TR5GP	3186	TR5	2238	.040
	V6 4.3L		<b>ITR4A15</b>	<b>5599</b>	TR5AHX	94567	TR55IX	7164	TR55GP	3403	TR55	3951	.060
1997-96	L4 2.2L		PZTR5A-15	7862			TR55-11X	7316	TR55-1GP	7159	TR55-1	2683	.060
	V6 4.3L		<b>ITR4A15</b>	<b>5599</b>	TR5AHX	94567	TR55IX	7164	TR55GP	3403	TR55	3951	.060
1995-94	L4 2.2L		PZTR5A-15	7862			TR55-11X	7316	TR55-1GP	7159	TR55-1	2683	.060
	V6 4.3L		UR5	2771			UR5IX	7177	UR5GP	3547	UR5	2771	.045
1993-88	L4 2.5L		UR55	2248			UR55IX	7272			UR55	2248	.060
	V6 2.8L		UR5	2771			UR5IX	7177	UR5GP	3547	UR5	2771	.045
	V6 4.3L		UR5	2771			UR5IX	7177	UR5GP	3547	UR5	2771	.035
1987-86	L4 2.5L		UR55	2248			UR55IX	7272			UR55	2248	.060
	V6 2.8L		UR5	2771			UR5IX	7177	UR5GP	3547	UR5	2771	.045
1985	L4 1.9L		GR5	2851			GR5IX	7214	GR5GP	3351	GR5	2851	.040
	L4 2.5L		UR55	2248			UR55IX	7272			UR55	2248	.060
	V6 2.8L		UR5	2771			UR5IX	7177	UR5GP	3547	UR5	2771	.045
<b>S10 Blazer</b>													
1994	V6 4.3L		UR5	2771			UR5IX	7177	UR5GP	3547	UR5	2771	.045
1993-90	V6 4.3L		UR5	2771			UR5IX	7177	UR5GP	3547	UR5	2771	.035
1989	V6 2.8L		UR5	2771			UR5IX	7177	UR5GP	3547	UR5	2771	.045



Year	Cyl. L	Notes	Original Equipment		Ruthenium HX		Iridium IX		G-Power		V-Power		Gap
			Part	Stock	Part	Stock	Part	Stock	Part	Stock	Part	Stock	
<b>CHEVROLET (Cont'd)</b>													
<b>S10 Blazer (Cont'd)</b>													
1989	V6 4.3L		UR5	2771			UR5IX	7177	UR5GP	3547	UR5	2771	.035
1988	L4 2.5L		UR55	2248			UR55IX	7272			UR55	2248	.060
	V6 2.8L		UR5	2771			UR5IX	7177	UR5GP	3547	UR5	2771	.045
	V6 4.3L		UR5	2771			UR5IX	7177	UR5GP	3547	UR5	2771	.035
1987-85	L4 2.5L		UR55	2248			UR55IX	7272			UR55	2248	.060
	V6 2.8L		UR5	2771			UR5IX	7177	UR5GP	3547	UR5	2771	.045
<b>Silverado 1500</b>													
2018-14	V6 4.3L		ILTR5B11	3474	LTR5AHX	90220	LTR5IX-11	4344	LTR5GP	5019			.044
	V8 5.3L		ILTR5B11	3474	LTR5AHX	90220	LTR5IX-11	4344	LTR5GP	5019			.044
	V8 6.2L		ILTR5B11	3474	LTR5AHX	90220	LTR5IX-11	4344	LTR5GP	5019			.044
2013-09	V6 4.3L		<b>ITR4A15</b>	<b>5599</b>	TR4BHX	97100	TR55IX	7164	TR55GP	3403	TR55	3951	.060
	V8 4.8L		IZTR5B11	1465	TR5AHX	94567	TR5IX	7397	TR5GP	3186	TR5	2238	.040
	V8 5.3L		IZTR5B11	1465	TR5AHX	94567	TR5IX	7397	TR5GP	3186	TR5	2238	.040
	V8 6.0L		IZTR5B11	1465	TR5AHX	94567	TR5IX	7397	TR5GP	3186	TR5	2238	.040
	V8 6.2L		IZTR5B11	1465	TR5AHX	94567	TR5IX	7397	TR5GP	3186	TR5	2238	.040
2008-07	V6 4.3L		<b>ITR4A15</b>	<b>5599</b>	TR4BHX	97100	TR55IX	7164	TR55GP	3403	TR55	3951	.060
	V8 4.8L		IZTR5B11	1465	TR5AHX	94567	TR5IX	7397	TR5GP	3186	TR5	2238	.040
	V8 5.3L		IZTR5B11	1465	TR5AHX	94567	TR5IX	7397	TR5GP	3186	TR5	2238	.040
	V8 6.0L		IZTR5B11	1465	TR5AHX	94567	TR5IX	7397	TR5GP	3186	TR5	2238	.040
2006-03	V6 4.3L		<b>ITR4A15</b>	<b>5599</b>	TR5AHX	94567	TR55IX	7164	TR55GP	3403	TR55	3951	.060
	V8 4.8L		IZTR5B11	1465	TR5AHX	94567	TR5IX	7397	TR5GP	3186	TR5	2238	.040
	V8 5.3L		IZTR5B11	1465	TR5AHX	94567	TR5IX	7397	TR5GP	3186	TR5	2238	.040
	V8 6.0L		IZTR5B11	1465	TR5AHX	94567	TR5IX	7397	TR5GP	3186	TR5	2238	.040
2002-99	V6 4.3L		<b>ITR4A15</b>	<b>5599</b>	TR5AHX	94567	TR55IX	7164	TR55GP	3403	TR55	3951	.060
	V8 4.8L		IZTR5B11	1465	TR5AHX	94567	TR5IX	7397	TR5GP	3186	TR5	2238	.040
	V8 5.3L		IZTR5B11	1465	TR5AHX	94567	TR5IX	7397	TR5GP	3186	TR5	2238	.040
<b>Silverado 1500 Classic</b>													
2007	V6 4.3L		<b>ITR4A15</b>	<b>5599</b>	TR5AHX	94567	TR55IX	7164	TR55GP	3403	TR55	3951	.060
	V8 4.8L		IZTR5B11	1465	TR5AHX	94567	TR5IX	7397	TR5GP	3186	TR5	2238	.040
	V8 5.3L		IZTR5B11	1465	TR5AHX	94567	TR5IX	7397	TR5GP	3186	TR5	2238	.040
	V8 6.0L		IZTR5B11	1465	TR5AHX	94567	TR5IX	7397	TR5GP	3186	TR5	2238	.040
<b>Silverado 1500 HD</b>													
2006-05	V8 6.0L		IZTR5B11	1465	TR5AHX	94567	TR5IX	7397	TR5GP	3186	TR5	2238	.040
2003-01	V8 6.0L		IZTR5B11	1465	TR5AHX	94567	TR5IX	7397	TR5GP	3186	TR5	2238	.040
<b>Silverado 1500 HD Classic</b>													
2007	V8 6.0L		IZTR5B11	1465	TR5AHX	94567	TR5IX	7397	TR5GP	3186	TR5	2238	.040
<b>Silverado 2500</b>													
2004-01	V8 6.0L		IZTR5B11	1465	TR5AHX	94567	TR5IX	7397	TR5GP	3186	TR5	2238	.040
2000-99	V8 5.3L		IZTR5B11	1465	TR5AHX	94567	TR5IX	7397	TR5GP	3186	TR5	2238	.040
	V8 6.0L		IZTR5B11	1465	TR5AHX	94567	TR5IX	7397	TR5GP	3186	TR5	2238	.040
<b>Silverado 2500 HD</b>													
2018-12	V8 6.0L		IZTR5B11	1465	TR5AHX	94567	TR5IX	7397	TR5GP	3186	TR5	2238	.040
2011-07	V8 6.0L		IZTR5B11	1465	TR5AHX	94567	TR5IX	7397	TR5GP	3186	TR5	2238	.040
	V8 6.6L	DIESEL	Y1033AS	90046									
2006	V8 6.0L		IZTR5B11	1465	TR5AHX	94567	TR5IX	7397	TR5GP	3186	TR5	2238	.040
	V8 6.6L	Vin 2, DIESEL, w/ Hex Threads Located Middle of Glow Plug	Y1033AS	90046									
		Vin 2, DIESEL, w/ Hex Threads Located Near Top of Glow Plug (LLY Engine Only)	Y1032AS	97788									
		Vin D, DIESEL	Y1033AS	90046									
	V8 8.1L		PZTR5A-15	7862	TR5AHX	94567	TR55IX	7164	TR55GP	3403	TR55	3951	.060
2005	V8 6.0L		IZTR5B11	1465	TR5AHX	94567	TR5IX	7397	TR5GP	3186	TR5	2238	.040
	V8 6.6L	DIESEL	Y1032AS	97788									
	V8 8.1L		PZTR5A-15	7862	TR5AHX	94567	TR55IX	7164	TR55GP	3403	TR55	3951	.060
2004	V8 6.0L		IZTR5B11	1465	TR5AHX	94567	TR5IX	7397	TR5GP	3186	TR5	2238	.040

**Bold denotes NGK OE Manufacturer and/or OE Service Part**  
NOT BOLD denotes OE Equivalent Part

Note: Due to different operating or engine conditions, alternate heat range plugs may be required.

109

**Le texte en gras désigne une pièce d'équipement originale du manufacturier NGK et/ou pièce d'équipement originale de service**  
Le texte non en gras désigne une pièce d'équipement originale équivalente

Note: En raison de différences au niveau du fonctionnement ou des conditions du moteur, d'autres types de bougies avec variation de chaleur peuvent être nécessaires



Year	Cyl. L	Notes	Original Equipment		Ruthenium HX		Iridium IX		G-Power		V-Power		Gap
			Part	Stock	Part	Stock	Part	Stock	Part	Stock	Part	Stock	
<b>CHEVROLET (Cont'd)</b>													
Silverado 2500 HD (Cont'd)													
2004	V8 6.6L	Vin 2, DIESEL	Y1032AS	97788									
	V8 8.1L		<b>PZTR5A-15</b>	<b>7862</b>	TR5AHX	94567	TR55IX	7164	TR55GP	3403	TR55	3951	.060
2003	V8 6.0L		IZTR5B11	1465	TR5AHX	94567	TR5IX	7397	TR5GP	3186	TR5	2238	.040
	V8 8.1L		PZTR5A-15	7862	TR5AHX	94567	TR55IX	7164	TR55GP	3403	TR55	3951	.060
2002-01	V8 6.0L		IZTR5B11	1465	TR5AHX	94567	TR5IX	7397	TR5GP	3186	TR5	2238	.040
	V8 8.1L		<b>PZTR5A-15</b>	<b>7862</b>	TR5AHX	94567	TR55IX	7164	TR55GP	3403	TR55	3951	.060
Silverado 2500 HD Classic													
2007	V8 6.0L		IZTR5B11	1465	TR5AHX	94567	TR5IX	7397	TR5GP	3186	TR5	2238	.040
	V8 8.1L		PZTR5A-15	7862	TR5AHX	94567	TR55IX	7164	TR55GP	3403	TR55	3951	.060
Silverado 3500													
2006	V8 6.0L		IZTR5B11	1465	TR5AHX	94567	TR5IX	7397	TR5GP	3186	TR5	2238	.040
	V8 6.6L	Vin 2, DIESEL, w/ Hex Threads Located Middle of Glow Plug	Y1033AS	90046									
		Vin 2, DIESEL, w/ Hex Threads Located Near Top of Glow Plug (LLY Engine Only)	Y1032AS	97788									
	Vin D, DIESEL		Y1033AS	90046									
V8 8.1L		PZTR5A-15	7862	TR5AHX	94567	TR55IX	7164	TR55GP	3403	TR55	3951	.060	
2005	V8 6.0L		IZTR5B11	1465	TR5AHX	94567	TR5IX	7397	TR5GP	3186	TR5	2238	.040
	V8 6.6L	DIESEL	Y1032AS	97788									
	V8 8.1L		PZTR5A-15	7862	TR5AHX	94567	TR55IX	7164	TR55GP	3403	TR55	3951	.060
2004	V8 6.0L		IZTR5B11	1465	TR5AHX	94567	TR5IX	7397	TR5GP	3186	TR5	2238	.040
	V8 8.1L		<b>PZTR5A-15</b>	<b>7862</b>	TR5AHX	94567	TR55IX	7164	TR55GP	3403	TR55	3951	.060
2003	V8 6.0L		IZTR5B11	1465	TR5AHX	94567	TR5IX	7397	TR5GP	3186	TR5	2238	.040
	V8 8.1L		PZTR5A-15	7862	TR5AHX	94567	TR55IX	7164	TR55GP	3403	TR55	3951	.060
2002-01	V8 6.0L		IZTR5B11	1465	TR5AHX	94567	TR5IX	7397	TR5GP	3186	TR5	2238	.040
	V8 8.1L		<b>PZTR5A-15</b>	<b>7862</b>	TR5AHX	94567	TR55IX	7164	TR55GP	3403	TR55	3951	.060
Silverado 3500 Classic													
2007	V8 6.0L		IZTR5B11	1465	TR5AHX	94567	TR5IX	7397	TR5GP	3186	TR5	2238	.040
	V8 6.6L	DIESEL	Y1033AS	90046									
	V8 8.1L		PZTR5A-15	7862	TR5AHX	94567	TR55IX	7164	TR55GP	3403	TR55	3951	.060
Silverado 3500 HD													
2018-12	V8 6.0L		IZTR5B11	1465	TR5AHX	94567	TR5IX	7397	TR5GP	3186	TR5	2238	.040
2011-07	V8 6.0L		IZTR5B11	1465	TR5AHX	94567	TR5IX	7397	TR5GP	3186	TR5	2238	.040
	V8 6.6L	DIESEL	Y1033AS	90046									
Sonic													
2018-16	L4 1.4L		<b>IFR7X7G</b>	<b>91039</b>	FR7BHX-S	92400							.027
	L4 1.8L		<b>IFR6Z7G</b>	<b>95609</b>	FR6BHX-S	95159							.027
2015-12	L4 1.4L		<b>IFR7X7G</b>	<b>91039</b>	FR7BHX-S	92400							.027
	L4 1.8L		<b>IFR6Z7G</b>	<b>95609</b>	FR6AHX-S	94279							.027
Spark													
2018-16	L4 1.4L		<b>SILZNR6D9</b>	<b>94051</b>									.027
2015-13	L4 1.2L		IKR7H8	91715			DCPR7EIX	6046	DCPR7EGP	1682			.036
Spectrum													
1988-85	L4 1.5L		GR5	2851			GR5IX	7214	GR5GP	3351	GR5	2851	.045
Sprint													
1992-89	L3 1.0L	Naturally Aspirated	<b>BPR5ES-11</b>	<b>7634</b>			BPR5EIX-11	2115	BPR5EGP	7082	BPR5EY-11	6937	.040
		Turbo	<b>BPR6ES-11</b>	<b>7133</b>			BPR6EIX-11	3903	BPR6EGP	7084	BPR6EY-11	6261	.042
1988-87	L3 1.0L	Naturally Aspirated	GR5	2851			GR5IX	7214	GR5GP	3351	GR5	2851	.045
		Turbo	<b>BPR6ES-11</b>	<b>7133</b>			BPR6EIX-11	3903	BPR6EGP	7084	BPR6EY-11	6261	.042
1986-85	L3 1.0L		GR5	2851			GR5IX	7214	GR5GP	3351	GR5	2851	.045
SS													
2017-15	V8 6.2L		IZTR5B11	1465	TR5AHX	94567	TR5IX	7397	TR5GP	3186	TR5	2238	.040
2014	V8 6.2L		<b>PTR5D-10</b>	<b>3784</b>	TR5AHX	94567	TR5IX	7397	TR5GP	3186	TR5	2238	.040
SSR													
2006-05	V8 6.0L		IZTR5B11	1465	TR5AHX	94567	TR5IX	7397	TR5GP	3186	TR5	2238	.040

110 **Bold denotes NGK OE Manufacturer and/or OE Service Part**  
NOT BOLD denotes OE Equivalent Part

Note: Due to different operating or engine conditions, alternate heat range plugs may be required.

El texto marcado en negrita indica que NGK es el proveedor para Equipo Original y/o Repuesto de Equipo Original.  
El texto sin negritas marca que es un equivalente al Equipo Original.

Nota: Debido a las diferentes condiciones de operación del motor, se puede requerir un rango térmico alterno.





Year	Cyl. L	Notes	Original Equipment		Ruthenium HX		Iridium IX		G-Power		V-Power		Gap
			Part	Stock	Part	Stock	Part	Stock	Part	Stock	Part	Stock	
<b>CHEVROLET (Cont'd)</b>													
<b>SSR (Cont'd)</b>													
2004-03	V8 5.3L		IZTR5B11	1465	TR5AHX	94567	TR5IX	7397	TR5GP	3186	TR5	2238	.040
Suburban													
2018-15	V8 5.3L		ILTR5B11	3474	LTR5AHX	90220	LTR5IX-11	4344	LTR5GP	5019			.044
Suburban 1500													
2014-13	V8 5.3L		PTR5D-10	3784	TR5AHX	94567	TR5IX	7397	TR5GP	3186	TR5	2238	.040
2012-10	V8 5.3L		IZTR5B11	1465	TR5AHX	94567	TR5IX	7397	TR5GP	3186	TR5	2238	.040
2009-06	V8 5.3L		IZTR5B11	1465	TR5AHX	94567	TR5IX	7397	TR5GP	3186	TR5	2238	.040
	V8 6.0L		IZTR5B11	1465	TR5AHX	94567	TR5IX	7397	TR5GP	3186	TR5	2238	.040
2005-00	V8 5.3L		PTR5D-10	3784	TR5AHX	94567	TR5IX	7397	TR5GP	3186	TR5	2238	.040
Suburban 2500													
2013	V8 6.0L		PTR5D-10	3784	TR5AHX	94567	TR5IX	7397	TR5GP	3186	TR5	2238	.040
2012-07	V8 6.0L		IZTR5B11	1465	TR5AHX	94567	TR5IX	7397	TR5GP	3186	TR5	2238	.040
2006-03	V8 6.0L		IZTR5B11	1465	TR5AHX	94567	TR5IX	7397	TR5GP	3186	TR5	2238	.040
	V8 8.1L		PZTR5A-15	7862	TR5AHX	94567	TR55IX	7164	TR55GP	3403	TR55	3951	.060
2002-01	V8 6.0L		IZTR5B11	1465	TR5AHX	94567	TR5IX	7397	TR5GP	3186	TR5	2238	.040
	V8 8.1L		<b>PZTR5A-15</b>	<b>7862</b>	TR5AHX	94567	TR55IX	7164	TR55GP	3403	TR55	3951	.060
2000	V8 6.0L		IZTR5B11	1465	TR5AHX	94567	TR5IX	7397	TR5GP	3186	TR5	2238	.040
Suburban 3500 HD													
2018-16	V8 6.0L		IZTR5B11	1465	TR5AHX	94567	TR5IX	7397	TR5GP	3186	TR5	2238	.040
Tahoe													
2018	V8 5.3L		ILTR5B11	3474	LTR5AHX	90220	LTR5IX-11	4344	LTR5GP	5019			.044
	V8 6.2L		ILTR5B11	3474	LTR5AHX	90220	LTR5IX-11	4344	LTR5GP	5019			.044
2017-15	V8 5.3L		ILTR5B11	3474	LTR5AHX	90220	LTR5IX-11	4344	LTR5GP	5019			.044
2014	V8 5.3L		PTR5D-10	3784	TR5AHX	94567	TR5IX	7397	TR5GP	3186	TR5	2238	.040
2013	V8 5.3L		PTR5D-10	3784	TR5AHX	94567	TR5IX	7397	TR5GP	3186	TR5	2238	.040
	V8 6.0L		PTR5D-10	3784	TR5AHX	94567	TR5IX	7397	TR5GP	3186	TR5	2238	.040
2012-10	V8 5.3L		IZTR5B11	1465	TR5AHX	94567	TR5IX	7397	TR5GP	3186	TR5	2238	.040
	V8 6.0L		IZTR5B11	1465	TR5AHX	94567	TR5IX	7397	TR5GP	3186	TR5	2238	.040
2009-08	V8 4.8L		IZTR5B11	1465	TR5AHX	94567	TR5IX	7397	TR5GP	3186	TR5	2238	.040
	V8 5.3L		IZTR5B11	1465	TR5AHX	94567	TR5IX	7397	TR5GP	3186	TR5	2238	.040
	V8 6.0L		IZTR5B11	1465	TR5AHX	94567	TR5IX	7397	TR5GP	3186	TR5	2238	.040
	V8 6.2L		IZTR5B11	1465	TR5AHX	94567	TR5IX	7397	TR5GP	3186	TR5	2238	.040
2007-04	V8 4.8L		IZTR5B11	1465	TR5AHX	94567	TR5IX	7397	TR5GP	3186	TR5	2238	.040
	V8 5.3L		IZTR5B11	1465	TR5AHX	94567	TR5IX	7397	TR5GP	3186	TR5	2238	.040
2003-01	V8 4.8L		PTR5D-10	3784	TR5AHX	94567	TR5IX	7397	TR5GP	3186	TR5	2238	.040
	V8 5.3L		PTR5D-10	3784	TR5AHX	94567	TR5IX	7397	TR5GP	3186	TR5	2238	.040
2000	V8 4.8L		PTR5D-10	3784	TR5AHX	94567	TR5IX	7397	TR5GP	3186	TR5	2238	.040
	V8 5.3L		PTR5D-10	3784	TR5AHX	94567	TR5IX	7397	TR5GP	3186	TR5	2238	.040
	V8 5.7L		<b>ITR4A15</b>	<b>5599</b>	TR5AHX	94567	TR55IX	7164	TR55GP	3403	TR55	3951	.060
1999-97	V8 5.7L		<b>ITR4A15</b>	<b>5599</b>	TR5AHX	94567	TR55IX	7164	TR55GP	3403	TR55	3951	.060
1996	V8 5.7L		<b>ITR4A15</b>	<b>5599</b>			TR55IX	7164	TR55GP	3403	TR55	3951	.060
1995	V8 5.7L		UR5	2771			UR5IX	7177	UR5GP	3547	UR5	2771	.035
Tracker													
2004	V6 2.5L		<b>IFR5J11</b>	<b>7418</b>	FR5AHX	95839	BKR5EIX-11	5464	BKR5EGP	7090	BKR5E-11	6953	.044
2003	L4 2.0L		<b>IFR5J11</b>	<b>7418</b>	FR5AHX	95839	BKR5EIX-11	5464	BKR5EGP	7090	BKR5E-11	6953	.044
	V6 2.5L		<b>IFR5J11</b>	<b>7418</b>	FR5AHX	95839	BKR5EIX-11	5464	BKR5EGP	7090	BKR5E-11	6953	.044
2002-01	L4 1.6L		<b>IFR6E11</b>	<b>6741</b>	FR6AHX-S	94279	BKR6EIX-11	3764	BKR6EGP	7092	BKR6E-11	2756	.044
	L4 2.0L		<b>IFR5J11</b>	<b>7418</b>	FR5AHX	95839	BKR5EIX-11	5464	BKR5EGP	7090	BKR5EY-11	6745	.044
	V6 2.5L		<b>IFR5J11</b>	<b>7418</b>	FR5AHX	95839	BKR5EIX-11	5464	BKR5EGP	7090	BKR5E-11	6953	.044
2000-99	L4 1.6L		<b>IFR6E11</b>	<b>6741</b>	FR6BHX-S	95159	BKR6EIX-11	3764	BKR6EGP	7092	BKR6E-11	2756	.044
	L4 2.0L		<b>IFR6E11</b>	<b>6741</b>	FR6AHX-S	94279	BKR6EIX-11	3764	BKR6EGP	7092	BKR6E-11	2756	.044
1998	L4 1.6L		<b>BKR6E-11</b>	<b>2756</b>	FR6AHX-S	94279	BKR6EIX-11	3764	BKR6EGP	7092	BKR6E-11	2756	.042
1991-90	L4 1.6L		<b>BKR6E-11</b>	<b>2756</b>			BKR6EIX-11	3764	BKR6EGP	7092	BKR6E-11	2756	.042
1989	L4 1.6L		<b>BKR6E</b>	<b>6962</b>			BKR6EIX-11	3764	BKR6EGP	7092	BKR6E	6962	.042
Trailblazer													
2009	L6 4.2L		<b>ILTR5E11</b>	<b>91418</b>	LTR5AHX	90220	LTR5IX-11	4344	LTR5GP	5019			.044
	V8 6.0L		IZTR5B11	1465	TR5AHX	94567	TR5IX	7397	TR5GP	3186	TR5	2238	.040

**Bold denotes NGK OE Manufacturer and/or OE Service Part**  
NOT BOLD denotes OE Equivalent Part

Note: Due to different operating or engine conditions, alternate heat range plugs may be required.

**Le texte en gras désigne une pièce d'équipement originale du manufacturier NGK et/ou pièce d'équipement originale de service**  
Le texte non en gras désigne une pièce d'équipement originale équivalente

Note: En raison de différences au niveau du fonctionnement ou des conditions du moteur, d'autres types de bougies avec variation de chaleur peuvent être nécessaires



Year	Cyl. L	Notes	Original Equipment		Ruthenium HX		Iridium IX		G-Power		V-Power		Gap
			Part	Stock	Part	Stock	Part	Stock	Part	Stock	Part	Stock	
<b>CHEVROLET (Cont'd)</b>													
Trailblazer (Cont'd)													
2008-06	L6 4.2L		<b>ILTR5E11</b>	<b>91418</b>	LTR5AHX	90220	LTR5IX-11	4344	LTR5GP	5019			.044
	V8 5.3L		IZTR5B11	1465	TR5AHX	94567	TR5IX	7397	TR5GP	3186	TR5	2238	.040
	V8 6.0L		IZTR5B11	1465	TR5AHX	94567	TR5IX	7397	TR5GP	3186	TR5	2238	.040
2005-02	L6 4.2L		<b>ILTR5E11</b>	<b>91418</b>	LTR5AHX	90220	LTR5IX-11	4344	LTR5GP	5019			.044
Trailblazer EXT													
2006-03	L6 4.2L		<b>ILTR5E11</b>	<b>91418</b>	LTR5AHX	90220	LTR5IX-11	4344	LTR5GP	5019			.044
	V8 5.3L		IZTR5B11	1465	TR5AHX	94567	TR5IX	7397	TR5GP	3186	TR5	2238	.040
2002	L6 4.2L		<b>ILTR5E11</b>	<b>91418</b>	LTR5AHX	90220	LTR5IX-11	4344	LTR5GP	5019			.044
Traverse													
2018	L4 2.0L		<b>ILTR6M9G</b>	<b>94489</b>	LTR6BHX	90495							.036
	V6 3.6L		<b>ILTR6E11</b>	<b>90117</b>	LTR6AHX	91276	LTR6IX-11	6509	LTR6GP	90198			.044
2017-09	V6 3.6L		<b>ILTR6E11</b>	<b>90117</b>	LTR6AHX	91276	LTR6IX-11	6509	LTR6GP	90198			.044
Trax													
2018-13	L4 1.4L		<b>IFR7X7G</b>	<b>91039</b>	FR7BHX-S	92400							.027
Uplander													
2009-07	V6 3.9L		<b>IZTR4A11</b>	<b>4213</b>			TR4IX	7300	TR4GP	2815	TR4	3754	.044
2006	V6 3.5L		<b>ITR4A15</b>	<b>5599</b>	TR4BHX	97100	TR55IX	7164	TR55GP	3403	TR55	3951	.060
	V6 3.9L		<b>IZTR4A11</b>	<b>4213</b>			TR4IX	7300	TR4GP	2815	TR4	3754	.044
2005	V6 3.5L		<b>ITR4A15</b>	<b>5599</b>	TR4BHX	97100	TR55IX	7164	TR55GP	3403	TR55	3951	.060
V10													
1987	V6 4.3L		UR5	2771			UR5IX	7177	UR5GP	3547	UR5	2771	.035
	V8 5.0L		UR5	2771			UR5IX	7177	UR5GP	3547	UR5	2771	.035
	V8 5.7L		UR5	2771			UR5IX	7177	UR5GP	3547	UR5	2771	.035
V10 Suburban													
1988-87	V8 5.7L		UR5	2771			UR5IX	7177	UR5GP	3547	UR5	2771	.035
V20													
1987	L6 4.8L		YR5	7052			YR5IX	7516	YR5GP	2953	YR5	7052	.035
	V8 5.7L		UR5	2771			UR5IX	7177	UR5GP	3547	UR5	2771	.035
V20 Suburban													
1988-87	V8 5.7L		UR5	2771			UR5IX	7177	UR5GP	3547	UR5	2771	.035
	V8 7.4L		UR5	2771			UR5IX	7177	UR5GP	3547	UR5	2771	.035
V30													
1988	L6 4.8L		YR5	7052			YR5IX	7516	YR5GP	2953	YR5	7052	.035
		CARB	YR5	7052			YR5IX	7516	YR5GP	2953	YR5	7052	.035
	V8 5.7L	FI	UR5	2771			UR5IX	7177	UR5GP	3547	UR5	2771	.035
		CARB	UR5	2771			UR5IX	7177	UR5GP	3547	UR5	2771	.045
	V8 7.4L	FI	UR5	2771			UR5IX	7177	UR5GP	3547	UR5	2771	.035
		CARB	UR5	2771			UR5IX	7177	UR5GP	3547	UR5	2771	.035
1987	L6 4.8L		YR5	7052			YR5IX	7516	YR5GP	2953	YR5	7052	.035
		CARB	YR5	7052			YR5IX	7516	YR5GP	2953	YR5	7052	.045
	V8 5.7L	FI	UR5	2771			UR5IX	7177	UR5GP	3547	UR5	2771	.035
		CARB	YR5	7052			YR5IX	7516	YR5GP	2953	YR5	7052	.035
	V8 7.4L	FI	UR5	2771			UR5IX	7177	UR5GP	3547	UR5	2771	.035
		CARB	YR5	7052			YR5IX	7516	YR5GP	2953	YR5	7052	.035
V1500 Suburban													
1991-89	V8 5.7L		UR5	2771			UR5IX	7177	UR5GP	3547	UR5	2771	.035
V2500 Suburban													
1991	V8 5.7L		UR5	2771			UR5IX	7177	UR5GP	3547	UR5	2771	.035
1990	V8 5.7L		UR5	2771			UR5IX	7177	UR5GP	3547	UR5	2771	.035
	V8 7.4L		UR5	2771			UR5IX	7177	UR5GP	3547	UR5	2771	.035
1989	V8 5.7L		UR5	2771			UR5IX	7177	UR5GP	3547	UR5	2771	.035
V3500													
1991-90	V8 5.7L		UR5	2771			UR5IX	7177	UR5GP	3547	UR5	2771	.035
	V8 7.4L		UR5	2771			UR5IX	7177	UR5GP	3547	UR5	2771	.035
1989	V8 5.7L		UR5	2771			UR5IX	7177	UR5GP	3547	UR5	2771	.035
	V8 7.4L	CARB	YR5	7052			YR5IX	7516	YR5GP	2953	YR5	7052	.045
FI		UR5	2771			UR5IX	7177	UR5GP	3547	UR5	2771	.035	
Venture													
2005-02	V6 3.4L		<b>ITR4A15</b>	<b>5599</b>	TR4BHX	97100	TR55IX	7164	TR55GP	3403	TR55	3951	.060



Year	Cyl. L	Notes	Original Equipment		Ruthenium HX		Iridium IX		G-Power		V-Power		Gap
			Part	Stock	Part	Stock	Part	Stock	Part	Stock	Part	Stock	
<b>CHEVROLET (Cont'd)</b>													
<b>Venture (Cont'd)</b>													
2001-97	V6 3.4L		ITR4A15	5599	TR4BHX	97100	TR55IX	7164	TR55GP	3403	TR55	3951	.060
<b>Volt</b>													
2018-16	L4 1.5L		<b>SILZNR6D9</b>	<b>94051</b>									.027
2015-11	L4 1.4L		<b>IFR6Z7G</b>	<b>95609</b>	FR6AHX-S	94279							.027
<b>CHRYSLER</b>													
<b>200</b>													
2017-15	L4 2.4L		LZFR5CI-11	92145	LFR5AHX	96355	LFR5AIX-11	4469	LFR5AGP	5018			.047
	V6 3.6L		SILZKR7B11	9723	LKR7BHX	94705	LKR7DIX-11S	93175	LKR7BGP-S	97390			.044
2014-11	L4 2.4L	Eng Desg ED3, Non-PZEV Eng.	<b>ZFR5F-11</b>	<b>2262</b>	FR5AHX	95839	ZFR5FIX-11	2477	ZFR5FGP	7098	ZFR5F-11	2262	.044
		PZEV, Eng Desg EDG	<b>ZFR5AP</b>	<b>92041</b>	FR5AHX-E	92375	ZFR5FIX-E	95332	ZFR5FGP-8E	92459			.032
	V6 3.6L		SILZKR7B11	9723	LKR7BHX	94705	LKR7DIX-11S	93175	LKR7BGP-S	97390			.044
<b>300</b>													
2017-15	V6 3.6L		SILZKR7B11	9723	LKR7BHX	94705	LKR7DIX-11S	93175	LKR7BGP-S	97390			.044
	V8 5.7L	Dual Plug; 16 Req'd	<b>LZFR5CI-11</b>	<b>92145</b>	LFR5AHX	96355	LFR5AIX-11	4469	LFR5AGP	5018			.044
2014	V6 3.6L		SILZKR7B11	9723	LKR7BHX	94705	LKR7DIX-11S	93175	LKR7BGP-S	97390			.044
	V8 5.7L	Dual Plug; 16 Req'd	<b>LZFR5CI-11</b>	<b>92145</b>	LFR5AHX	96355	LFR5AIX-11	4469	LFR5AGP	5018			.044
	V8 6.4L	Dual Plug; 16 Req'd	<b>LZTR6AP11EG</b>	<b>97408</b>									.044
2013-12	V6 3.6L		SILZKR7B11	9723	LKR7BHX	94705	LKR7DIX-11S	93175	LKR7BGP-S	97390			.044
	V8 5.7L	Dual Plug; 16 Req'd	<b>LZFR5C-11</b>	<b>92174</b>	LFR5AHX	96355	LFR5AIX-11	4469	LFR5AGP	5018			.044
	V8 6.4L	Dual Plug; 16 Req'd	<b>LZTR6AP11EG</b>	<b>97408</b>									.044
2011	V6 3.6L		SILZKR7B11	9723	LKR7BHX	94705	LKR7DIX-11S	93175	LKR7BGP-S	97390			.044
	V8 5.7L	Dual Plug; 16 Req'd	<b>LZFR5C-11</b>	<b>92174</b>	LFR5AHX	96355	LFR5AIX-11	4469	LFR5AGP	5018			.044
2010-09	V6 2.7L		PLZTR5A-13	4998			LZTR5AIX-13	2314	LZTR5AGP	3381	LZTR5A-13	4306	.050
	V6 3.5L		<b>ZFR5LP-13G</b>	<b>7781</b>			ZFR5FIX-11E	96807	ZFR5FGP-E	94407			.052
	V8 5.7L	Dual Plug; 16 Req'd	<b>LZFR5C-11</b>	<b>92174</b>	LFR5AHX	96355	LFR5AIX-11	4469	LFR5AGP	5018			.044
	V8 6.1L	Dual Plug; 16 Req'd	<b>PLZTR5A-13</b>	<b>4998</b>			LZTR5AIX-13	2314	LZTR5AGP	3381	LZTR5A-13	4306	.052
2008-07	V6 2.7L		PLZTR5A-13	4998			LZTR5AIX-13	2314	LZTR5AGP	3381	LZTR5A-13	4306	.050
	V6 3.5L		<b>ZFR5LP-13G</b>	<b>7781</b>			ZFR5FIX-11E	96807	ZFR5FGP-E	94407			.052
	V8 5.7L	Dual Plug; 16 Req'd	LZTR4A-11	5306			LZTR4AIX-11	2313	LZTR4AGP	5017	LZTR4A-11	5306	.044
	V8 6.1L	Dual Plug; 16 Req'd	<b>PLZTR5A-13</b>	<b>4998</b>			LZTR5AIX-13	2314	LZTR5AGP	3381	LZTR5A-13	4306	.052
2006	V6 2.7L		PLZTR5A-13	4998			LZTR5AIX-13	2314	LZTR5AGP	3381	LZTR5A-13	4306	.052
	V6 3.5L		<b>ZFR5LP-13G</b>	<b>7781</b>			ZFR5FIX-11E	96807	ZFR5FGP-E	94407			.052
	V8 5.7L	Dual Plug; 16 Req'd	LZTR4A-11	5306			LZTR4AIX-11	2313	LZTR4AGP	5017	LZTR4A-11	5306	.044
	V8 6.1L	Dual Plug; 16 Req'd	<b>PLZTR5A-13</b>	<b>4998</b>			LZTR5AIX-13	2314	LZTR5AGP	3381	LZTR5A-13	4306	.052
2005	V6 2.7L		<b>PLZTR5A-13</b>	<b>4998</b>			LZTR5AIX-13	2314	LZTR5AGP	3381	LZTR5A-13	4306	.052
	V6 3.5L		<b>ZFR5LP-13G</b>	<b>7781</b>			ZFR5FIX-11E	96807	ZFR5FGP-E	94407			.052
	V8 5.7L	Dual Plug; 16 Req'd	LZTR4A-11	5306			LZTR4AIX-11	2313	LZTR4AGP	5017	LZTR4A-11	5306	.044
	V8 6.1L	Dual Plug; 16 Req'd	<b>PLZTR5A-13</b>	<b>4998</b>			LZTR5AIX-13	2314	LZTR5AGP	3381	LZTR5A-13	4306	.052
<b>300M</b>													
2004-03	V6 3.5L		<b>ZFR5LP-13G</b>	<b>7781</b>			ZFR5FIX-11E	96807	ZFR5FGP-E	94407			.052
2002	V6 3.5L		<b>ZFR5LP-13G</b>	<b>7781</b>			ZFR5FIX-11E	96807	ZFR5FGP-E	94407			.050
2001-99	V6 3.5L		ZFR5LP-13G	7781			ZFR5FIX-11E	96807	ZFR5FGP-E	94407			.050
<b>Aspen</b>													
2009	V8 4.7L	Dual Plug; Exhaust Side (8 Req'd)	PLZFR5B13EG	97606			LZFR5AIX-11E	92460	LZFR5AGP-E	90192			.051
		Dual Plug; Intake Side (8 Req'd)	LZFR5C-11	92174			LFR5AIX-11	4469	LFR5AGP	5018			.039
	V8 5.7L	ELECTRIC/GAS, Dual Plug; 16 Req'd	<b>PLZFR5B13EG</b>	<b>97606</b>			LZFR5AIX-11E	92460	LZFR5AGP-E	90192			.052
		GAS, Dual Plug; 16 Req'd	<b>LZFR5C-11</b>	<b>92174</b>	LFR5AHX	96355	LFR5AIX-11	4469	LFR5AGP	5018			.044
2008	V8 4.7L	Dual Plug; Exhaust Side (8 Req'd)	PLZFR5B13EG	97606			LZFR5AIX-11E	92460	LZFR5AGP-E	90192			.051
		Dual Plug; Intake Side (8 Req'd)	LZFR5C-11	92174			LFR5AIX-11	4469	LFR5AGP	5018			.039
	V8 5.7L	Dual Plug; 16 Req'd	LZTR4A-11	5306			LZTR4AIX-11	2313	LZTR4AGP	5017	LZTR4A-11	5306	.044
2007	V8 4.7L		ZFR6F-11G	6987	FR6AHX-S	94279	ZFR6FIX-11	6441	ZFR6FGP	7100	ZFR6F-11G	6987	.044
	V8 5.7L	Dual Plug; 16 Req'd	LZTR4A-11	5306			LZTR4AIX-11	2313	LZTR4AGP	5017	LZTR4A-11	5306	.044

**Bold denotes NGK OE Manufacturer and/or OE Service Part**  
NOT BOLD denotes OE Equivalent Part

**Le texte en gras désigne une pièce d'équipement originale du manufacturier NGK et/ou pièce d'équipement originale de service**  
Le texte non en gras désigne une pièce d'équipement originale équivalente

Note: Due to different operating or engine conditions, alternate heat range plugs may be required.

Note: En raison de différences au niveau du fonctionnement ou des conditions du moteur, d'autres types de bougies avec variation de chaleur peuvent être nécessaires



Year	Cyl. L	Notes	Original Equipment		Ruthenium HX		Iridium IX		G-Power		V-Power		Gap
			Part	Stock	Part	Stock	Part	Stock	Part	Stock	Part	Stock	
<b>CHRYSLER (Cont'd)</b>													
<b>Cirrus</b>													
2000	L4 2.0L		BKR6E	6962	FR6BHX-S	95159	BKR6EIX	6418	BKR6EGP	7092	BKR6E	6962	.035
	L4 2.4L		FR45	3686					FR45GP	3072	FR45	3686	.050
	V6 2.5L		PFR5G-11	2647	FR5AHX	95839	BKR5EIX-11	5464	BKR5EGP	7090	BKR5E-11	6953	.044
1999	L4 2.4L		FR45	3686					FR45GP	3072	FR45	3686	.050
	V6 2.5L		PFR5G-11	2647	FR5AHX	95839	BKR5EIX-11	5464	BKR5EGP	7090	BKR5E-11	6953	.044
1998	V6 2.5L		PFR5G-11	2647	FR5AHX	95839	BKR5EIX-11	5464	BKR5EGP	7090	BKR5E-11	6953	.044
1997	L4 2.4L		FR45	3686					FR45GP	3072	FR45	3686	.050
	V6 2.5L		PFR5G-11	2647	FR5AHX	95839	BKR5EIX-11	5464	BKR5EGP	7090	BKR5E-11	6953	.044
1996-95	L4 2.4L		FR45	3686					FR45GP	3072	FR45	3686	.050
	V6 2.5L		PFR5G-11	2647			BKR5EIX-11	5464	BKR5EGP	7090	BKR5E-11	6953	.044
<b>Concorde</b>													
2004-03	V6 2.7L		PLZTR5A-13	4998			LZTR5AIX-13	2314	LZTR5AGP	3381	LZTR5A-13	4306	.052
	V6 3.5L		<b>ZFR5LP-13G</b>	<b>7781</b>			ZFR5FIX-11E	96807	ZFR5FGP-E	94407			.052
2002	V6 2.7L		PLZTR5A-13	4998			LZTR5AIX-13	2314	LZTR5AGP	3381	LZTR5A-13	4306	.052
	V6 3.5L		<b>ZFR5LP-13G</b>	<b>7781</b>			ZFR5FIX-11E	96807	ZFR5FGP-E	94407			.050
2001-98	V6 2.7L		PLZTR5A-13	4998			LZTR5AIX-13	2314	LZTR5AGP	3381	LZTR5A-13	4306	.052
	V6 3.2L		ZFR5LP-13G	7781			ZFR5FIX-11E	96807	ZFR5FGP-E	94407			.050
1997	V6 3.5L		FR5-1	7252						FR5-1	7252	.035	
1996-93	V6 3.3L		GR45	4268					GR45GP	3142	GR45	4268	.050
	V6 3.5L		FR5-1	7252							FR5-1	7252	.035
<b>Conquest</b>													
1989	L4 2.6L		<b>BPR7ES-11</b>	<b>7226</b>			BPR7EIX	4055					.044
1988-87	L4 2.6L		<b>BPR6ES-11</b>	<b>7133</b>			BPR6EIX-11	3903	BPR6EGP	7084	BPR6EY-11	6261	.044
<b>Crossfire</b>													
2008-07	V6 3.2L	Dual Plug; 12 Req'd	<b>PFR5R-11</b>	<b>4292</b>	FR5AHX	95839	BKR5EIX-11	5464	BKR5EGP	7090	BKR5E-11	6953	.044
2006-05	V6 3.2L	Naturally Aspirated, Dual Plug; 12 Req'd	<b>PFR5R-11</b>	<b>4292</b>	FR5AHX	95839	BKR5EIX-11	5464	BKR5EGP	7090	BKR5E-11	6953	.044
		Supercharged, Dual Plug; 12 Req'd	<b>IFR6D10</b>	<b>5344</b>	FR6BHX-S	95159	BKR6EIX-11	3764	BKR6EGP	7092	BKR6E-11	2756	.040
2004	V6 3.2L	Naturally Aspirated, Dual Plug; 12 Req'd	<b>PFR5R-11</b>	<b>4292</b>	FR5AHX	95839	BKR5EIX-11	5464	BKR5EGP	7090	BKR5E-11	6953	.044
<b>Daytona</b>													
1993-92	L4 2.2L		GR4	2635			GR4IX	97382	GR4GP	2763	GR4	2635	.035
	L4 2.5L		GR4	2635			GR4IX	97382	GR4GP	2763	GR4	2635	.035
	V6 3.0L		<b>BPR5ES-11</b>	<b>7634</b>			BPR5EIX-11	2115	BPR5EGP	7082	BPR5EY-11	6937	.045
1991	L4 2.5L		GR4	2635			GR4IX	97382	GR4GP	2763	GR4	2635	.035
	V6 3.0L		<b>BPR5ES-11</b>	<b>7634</b>			BPR5EIX-11	2115	BPR5EGP	7082	BPR5EY-11	6937	.045
1990	L4 2.2L	Base	GR4	2635			GR4IX	97382	GR4GP	2763	GR4	2635	.035
	L4 2.5L		GR4	2635			GR4IX	97382	GR4GP	2763	GR4	2635	.035
	V6 3.0L		<b>BPR5ES-11</b>	<b>7634</b>			BPR5EIX-11	2115	BPR5EGP	7082	BPR5EY-11	6937	.045
1989-88	L4 2.2L		GR4	2635			GR4IX	97382	GR4GP	2763	GR4	2635	.035
	L4 2.5L		GR4	2635			GR4IX	97382	GR4GP	2763	GR4	2635	.035
1987	L4 2.2L	Base	GR4	2635			GR4IX	97382	GR4GP	2763	GR4	2635	.035
		Pacifica	GR4	2635			GR4IX	97382	GR4GP	2763	GR4	2635	.035
		Shelby Z	BPR5EY	1233			BPR5EIX	6597	BPR5EGP	7082	BPR5EY	1233	.032
	L4 2.5L		GR4	2635			GR4IX	97382	GR4GP	2763	GR4	2635	.035
1986-85	L4 2.2L		GR4	2635			GR4IX	97382	GR4GP	2763	GR4	2635	.035
<b>Dynasty</b>													
1993-91	L4 2.5L		GR4	2635			GR4IX	97382	GR4GP	2763	GR4	2635	.035
	V6 3.3L		GR45	4268					GR45GP	3142	GR45	4268	.050
1990	L4 2.5L		GR4	2635			GR4IX	97382	GR4GP	2763	GR4	2635	.035
	V6 3.0L		<b>BPR5ES-11</b>	<b>7634</b>			BPR5EIX-11	2115	BPR5EGP	7082	BPR5EY-11	6937	.044
	V6 3.3L		GR45	4268					GR45GP	3142	GR45	4268	.050
1989-88	L4 2.5L		GR4	2635			GR4IX	97382	GR4GP	2763	GR4	2635	.035
	V6 3.0L		<b>BPR5ES-11</b>	<b>7634</b>			BPR5EIX-11	2115	BPR5EGP	7082	BPR5EY-11	6937	.044
<b>Executive Limousine</b>													
1985	L4 2.6L		<b>BPR5ES-11</b>	<b>7634</b>			BPR5EIX-11	2115	BPR5EGP	7082	BPR5EY-11	6937	.040



Year	Cyl. L	Notes	Original Equipment		Ruthenium HX		Iridium IX		G-Power		V-Power		Gap
			Part	Stock	Part	Stock	Part	Stock	Part	Stock	Part	Stock	
<b>CHRYSLER (Cont'd)</b>													
Fifth Avenue													
1989-85	V8 5.2L		GR4	2635			GR4IX	97382	GR4GP	2763	GR4	2635	.035
Grand Voyager													
2000	V6 3.0L		BPR5ES-11	7634			BPR5EIX-11	2115	BPR5EGP	7082	BPR5EY-11	6937	.044
	V6 3.3L		GR45GP	3142					GR45GP	3142	GR45	4268	.050
Imperial													
1993-92	V6 3.8L		GR45	4268					GR45GP	3142	GR45	4268	.050
1991	V6 3.3L		GR45	4268					GR45GP	3142	GR45	4268	.050
	V6 3.8L		GR45	4268					GR45GP	3142	GR45	4268	.050
1990	V6 3.3L		GR45	4268					GR45GP	3142	GR45	4268	.050
Intrepid													
2004-03	V6 2.7L		PLZTR5A-13	4998			LZTR5AIX-13	2314	LZTR5AGP	3381	LZTR5A-13	4306	.052
	V6 3.5L		<b>ZFR5LP-13G</b>	<b>7781</b>			ZFR5FIX-11E	96807	ZFR5FGP-E	94407			.052
2002	V6 2.7L		LZTR5A-13	4306			LZTR5AIX-13	2314	LZTR5AGP	3381	LZTR5A-13	4306	.052
	V6 3.5L		<b>ZFR5LP-13G</b>	<b>7781</b>			ZFR5FIX-11E	96807	ZFR5FGP-E	94407			.050
2001-00	V6 2.7L		PLZTR5A-13	4998			LZTR5AIX-13	2314	LZTR5AGP	3381	LZTR5A-13	4306	.052
	V6 3.2L		ZFR5LP-13G	7781			ZFR5FIX-11E	96807	ZFR5FGP-E	94407			.050
	V6 3.5L		ZFR5LP-13G	7781			ZFR5FIX-11E	96807	ZFR5FGP-E	94407			.050
1999-98	V6 2.7L		PLZTR5A-13	4998			LZTR5AIX-13	2314	LZTR5AGP	3381	LZTR5A-13	4306	.052
	V6 3.2L		ZFR5LP-13G	7781			ZFR5FIX-11E	96807	ZFR5FGP-E	94407			.050
1997-93	V6 3.3L		GR45	4268					GR45GP	3142	GR45	4268	.050
	V6 3.5L		FR5-1	7252							FR5-1	7252	.035
Laser													
1986	L4 2.2L		GR4	2635			GR4IX	97382	GR4GP	2763	GR4	2635	.035
	L4 2.5L		GR4	2635			GR4IX	97382	GR4GP	2763	GR4	2635	.035
1985	L4 2.2L		GR4	2635			GR4IX	97382	GR4GP	2763	GR4	2635	.035
LeBaron													
1995	V6 3.0L		<b>BPR5ES-11</b>	<b>7634</b>			BPR5EIX-11	2115	BPR5EGP	7082	BPR5EY-11	6937	.044
1994-91	L4 2.5L		GR4	2635			GR4IX	97382	GR4GP	2763	GR4	2635	.035
	V6 3.0L		<b>BPR5ES-11</b>	<b>7634</b>			BPR5EIX-11	2115	BPR5EGP	7082	BPR5EY-11	6937	.044
1990	L4 2.2L		GR4	2635			GR4IX	97382	GR4GP	2763	GR4	2635	.035
	L4 2.5L		GR4	2635			GR4IX	97382	GR4GP	2763	GR4	2635	.035
	V6 3.0L		<b>BPR5ES-11</b>	<b>7634</b>			BPR5EIX-11	2115	BPR5EGP	7082	BPR5EY-11	6937	.044
1989-86	L4 2.2L		GR4	2635			GR4IX	97382	GR4GP	2763	GR4	2635	.035
	L4 2.5L		GR4	2635			GR4IX	97382	GR4GP	2763	GR4	2635	.035
1985	L4 2.2L		GR4	2635			GR4IX	97382	GR4GP	2763	GR4	2635	.035
	L4 2.6L		<b>BPR5ES-11</b>	<b>7634</b>			BPR5EIX-11	2115	BPR5EGP	7082	BPR5EY-11	6937	.040
LHS													
2001-99	V6 3.5L		ZFR5LP-13G	7781			ZFR5FIX-11E	96807	ZFR5FGP-E	94407			.050
1997-94	V6 3.5L		FR5-1	7252							FR5-1	7252	.035
Neon													
2002-00	L4 2.0L		BKR6E	6962	FR6BHX-S	95159	BKR6EIX	6418	BKR6EGP	7092	BKR6E	6962	.035
New Yorker													
1996-94	V6 3.5L		FR5-1	7252							FR5-1	7252	.035
1993-91	V6 3.3L		GR45	4268					GR45GP	3142	GR45	4268	.050
	V6 3.8L		GR45	4268					GR45GP	3142	GR45	4268	.050
1990	V6 3.3L		GR45	4268					GR45GP	3142	GR45	4268	.050
1989	V6 3.0L		<b>BPR5ES-11</b>	<b>7634</b>			BPR5EIX-11	2115	BPR5EGP	7082	BPR5EY-11	6937	.044
1988	L4 2.2L		GR4	2635			GR4IX	97382	GR4GP	2763	GR4	2635	.035
	V6 3.0L		<b>BPR5ES-11</b>	<b>7634</b>			BPR5EIX-11	2115	BPR5EGP	7082	BPR5EY-11	6937	.044
1987-86	L4 2.2L		GR4	2635			GR4IX	97382	GR4GP	2763	GR4	2635	.035
	L4 2.5L		GR4	2635			GR4IX	97382	GR4GP	2763	GR4	2635	.035
1985	L4 2.2L		GR4	2635			GR4IX	97382	GR4GP	2763	GR4	2635	.035
	L4 2.6L		<b>BPR5ES-11</b>	<b>7634</b>			BPR5EIX-11	2115	BPR5EGP	7082	BPR5EY-11	6937	.040
Pacifica													
2017	V6 3.6L		ILZKR7B11	7751	LKR7AHX-S	96358	LKR7DIX-11S	93175	LKR7BGP-S	97390			.040
2008-07	V6 3.8L		PLZTR5A-13	4998			LZTR5AIX-13	2314	LZTR5AGP	3381	LZTR5A-13	4306	.050
	V6 4.0L		<b>ZFR5LP-13G</b>	<b>7781</b>			ZFR5FIX-11E	96807	ZFR5FGP-E	94407			.052

**Bold denotes NGK OE Manufacturer and/or OE Service Part**  
NOT BOLD denotes OE Equivalent Part

**Le texte en gras désigne une pièce d'équipement originale du manufacturier NGK et/ou pièce d'équipement originale de service**  
Le texte non en gras désigne une pièce d'équipement originale équivalente

Note: Due to different operating or engine conditions, alternate heat range plugs may be required.

Note: En raison de différences au niveau du fonctionnement ou des conditions du moteur, d'autres types de bougies avec variation de chaleur peuvent être nécessaires





Year	Cyl. L	Notes	Original Equipment		Ruthenium HX		Iridium IX		G-Power		V-Power		Gap
			Part	Stock	Part	Stock	Part	Stock	Part	Stock	Part	Stock	
<b>CHRYSLER (Cont'd)</b>													
Pacifica (Cont'd)													
2006-05	V6 3.5L		<b>ZFR5LP-13G</b>	<b>7781</b>			ZFR5FIX-11E	96807	ZFR5FGP-E	94407			.052
	V6 3.8L		PLZTR5A-13	4998			LZTR5AIX-13	2314	LZTR5AGP	3381	LZTR5A-13	4306	.050
2004	V6 3.5L		<b>ZFR5LP-13G</b>	<b>7781</b>			ZFR5FIX-11E	96807	ZFR5FGP-E	94407			.052
Prowler													
2002	V6 3.5L		<b>ZFR5LP-13G</b>	<b>7781</b>			ZFR5FIX-11E	96807	ZFR5FGP-E	94407			.050
2001	V6 3.5L		<b>ZFR5LP-13G</b>	<b>7781</b>			ZFR5FIX-11E	96807	ZFR5FGP-E	94407			.050
PT Cruiser													
2010	L4 2.4L	Naturally Aspirated	<b>LZTR4A-11</b>	<b>5306</b>			LZTR4AIX-11	2313	LZTR4AGP	5017	LZTR4A-11	5306	.044
2009-03	L4 2.4L	Naturally Aspirated	<b>LZTR4A-11</b>	<b>5306</b>			LZTR4AIX-11	2313	LZTR4AGP	5017	LZTR4A-11	5306	.044
		Turbo	LZTR5A-13	4306			LZTR5AIX-13	2314	LZTR5AGP	3381	LZTR5A-13	4306	.050
2002-01	L4 2.4L		<b>LZTR4A-11</b>	<b>5306</b>			LZTR4AIX-11	2313	LZTR4AGP	5017	LZTR4A-11	5306	.044
Sebring													
2010-09	L4 2.4L	Eng Desg ED3, Non-PZEV Eng.	<b>ZFR5F-11</b>	<b>2262</b>	FR5AHX	95839	ZFR5FIX-11	2477	ZFR5FGP	7098	ZFR5F-11	2262	.044
		PZEV, Eng Desg EDG	<b>ZFR5AP</b>	<b>92041</b>	FR5AHX-E	92375	ZFR5FIX-E	95332	ZFR5FGP-8E	92459			.032
	V6 2.7L		LZTR5A-13	4306			LZTR5AIX-13	2314	LZTR5AGP	3381	LZTR5A-13	4306	.050
	V6 3.5L		<b>ZFR5LP-13G</b>	<b>7781</b>			ZFR5FIX-11E	96807	ZFR5FGP-E	94407			.052
2008	L4 2.4L	PZEV, Eng Desg EDG	<b>ZFR5AP</b>	<b>92041</b>	FR5AHX-E	92375	ZFR5FIX-E	95332	ZFR5FGP-8E	92459			.032
	V6 2.7L		LZTR5A-13	4306			LZTR5AIX-13	2314	LZTR5AGP	3381	LZTR5A-13	4306	.050
	V6 3.5L		<b>ZFR5LP-13G</b>	<b>7781</b>			ZFR5FIX-11E	96807	ZFR5FGP-E	94407			.052
2007	L4 2.4L		<b>ZFR5F-11</b>	<b>2262</b>	FR5AHX	95839	ZFR5FIX-11	2477	ZFR5FGP	7098	ZFR5F-11	2262	.044
	V6 2.7L		LZTR5A-13	4306			LZTR5AIX-13	2314	LZTR5AGP	3381	LZTR5A-13	4306	.050
	V6 3.5L		<b>ZFR5LP-13G</b>	<b>7781</b>			ZFR5FIX-11E	96807	ZFR5FGP-E	94407			.052
2006	L4 2.4L		LZTR4A-11	5306			LZTR4AIX-11	2313	LZTR4AGP	5017	LZTR4A-11	5306	.044
	V6 2.7L		LZTR5A-13	4306			LZTR5AIX-13	2314	LZTR5AGP	3381	LZTR5A-13	4306	.052
2005-01	L4 2.4L	DOHC	LZTR4A-11	5306			LZTR4AIX-11	2313	LZTR4AGP	5017	LZTR4A-11	5306	.044
		SOHC	<b>BKR5E-11</b>	<b>6953</b>	FR5BHX	96457	BKR5EIX-11	5464	BKR5EGP	7090	BKR5E-11	6953	.044
	V6 2.7L		LZTR5A-13	4306			LZTR5AIX-13	2314	LZTR5AGP	3381	LZTR5A-13	4306	.052
	V6 3.0L		<b>PFR6G-11</b>	<b>5555</b>	FR6AHX-S	94279	BKR6EIX-11	3764	BKR6EGP	7092	BKR6E-11	2756	.044
2000	V6 2.5L		<b>PFR5G-11</b>	<b>2647</b>	FR5AHX	95839	BKR5EIX-11	5464	BKR5EGP	7090	BKR5E-11	6953	.044
1999	L4 2.0L		BKR6E-11	2756	FR6BHX-S	95159	BKR6EIX-11	3764	BKR6EGP	7092	BKR6E-11	2756	.050
	V6 2.5L		<b>PFR5G-11</b>	<b>2647</b>	FR5AHX	95839	BKR5EIX-11	5464	BKR5EGP	7090	BKR5E-11	6953	.044
1998-97	L4 2.0L		BKR6E-11	2756	FR6BHX-S	95159	BKR6EIX-11	3764	BKR6EGP	7092	BKR6E-11	2756	.050
	L4 2.4L		FR45	3686					FR45GP	3072	FR45	3686	.050
	V6 2.5L		<b>PFR5G-11</b>	<b>2647</b>	FR5AHX	95839	BKR5EIX-11	5464	BKR5EGP	7090	BKR5E-11	6953	.044
1996	L4 2.0L		BKR6E-11	2756			BKR6EIX-11	3764	BKR6EGP	7092	BKR6E-11	2756	.050
	L4 2.4L		FR45	3686					FR45GP	3072	FR45	3686	.050
	V6 2.5L		<b>PFR5G-11</b>	<b>2647</b>			BKR5EIX-11	5464	BKR5EGP	7090	BKR5E-11	6953	.044
1995	L4 2.0L		BKR6E-11	2756			BKR6EIX-11	3764	BKR6EGP	7092	BKR6E-11	2756	.050
	V6 2.5L		<b>PFR5G-11</b>	<b>2647</b>			BKR5EIX-11	5464	BKR5EGP	7090	BKR5E-11	6953	.044
TC Maserati													
1991	V6 3.0L		<b>BPR5ES-11</b>	<b>7634</b>			BPR5EIX-11	2115	BPR5EGP	7082	BPR5EY-11	6937	.044
1990	L4 2.2L		DR8EA	7162			DR8EIX	6681					.025
	V6 3.0L		<b>BPR5ES-11</b>	<b>7634</b>			BPR5EIX-11	2115	BPR5EGP	7082	BPR5EY-11	6937	.044
1989	L4 2.2L	DOHC	DR8EA	7162			DR8EIX	6681					.025
		SOHC	GR4	2635			GR4IX	97382	GR4GP	2763	GR4	2635	.045
Town & Country													
2016-11	V6 3.6L		SILZKR7B11	9723	LKR7BHX	94705	LKR7DIX-11S	93175	LKR7BGP-S	97390			.044
2010-08	V6 3.3L		PLZTR5A-13	4998			LZTR5AIX-13	2314	LZTR5AGP	3381	LZTR5A-13	4306	.050
	V6 3.8L		PLZTR5A-13	4998			LZTR5AIX-13	2314	LZTR5AGP	3381	LZTR5A-13	4306	.050
	V6 4.0L		<b>ZFR5LP-13G</b>	<b>7781</b>			ZFR5FIX-11E	96807	ZFR5FGP-E	94407			.052
2007-01	V6 3.3L		PLZTR5A-13	4998			LZTR5AIX-13	2314	LZTR5AGP	3381	LZTR5A-13	4306	.050
	V6 3.8L		PLZTR5A-13	4998			LZTR5AIX-13	2314	LZTR5AGP	3381	LZTR5A-13	4306	.050
2000-96	V6 3.3L		GR45GP	3142					GR45GP	3142	GR45	4268	.050
	V6 3.8L		GR45GP	3142					GR45GP	3142	GR45	4268	.050
1995-94	V6 3.8L		GR45	4268					GR45GP	3142	GR45	4268	.050



Year	Cyl. L	Notes	Original Equipment		Ruthenium HX		Iridium IX		G-Power		V-Power		Gap
			Part	Stock	Part	Stock	Part	Stock	Part	Stock	Part	Stock	
<b>CHRYSLER (Cont'd)</b>													
Town & Country (Cont'd)													
1993-90	V6 3.3L		GR45	4268					GR45GP	3142	GR45	4268	.050
1988-86	L4 2.2L		GR4	2635			GR4IX	97382	GR4GP	2763	GR4	2635	.035
	L4 2.5L		GR4	2635			GR4IX	97382	GR4GP	2763	GR4	2635	.035
1985	L4 2.2L		GR4	2635			GR4IX	97382	GR4GP	2763	GR4	2635	.035
	L4 2.6L		<b>BPR5ES-11</b>	<b>7634</b>			BPR5EIX-11	2115	BPR5EGP	7082	BPR5EY-11	6937	.040
Voyager													
2003-01	L4 2.4L		<b>LZTR4A-11</b>	<b>5306</b>			LZTR4AIX-11	2313	LZTR4AGP	5017	LZTR4A-11	5306	.044
	V6 3.3L		PLZTR5A-13	4998			LZTR5AIX-13	2314	LZTR5AGP	3381	LZTR5A-13	4306	.050
2000	L4 2.4L		FR45	3686					FR45GP	3072	FR45	3686	.050
	V6 3.0L		BPR5ES-11	7634			BPR5EIX-11	2115	BPR5EGP	7082	BPR5EY-11	6937	.044
	V6 3.3L		GR45GP	3142					GR45GP	3142	GR45	4268	.050
<b>DAEWOO</b>													
Lanos													
2002-99	L4 1.5L		<b>BPR6ES</b>	<b>7131</b>			BPR6EIX	6637	BPR6EGP	7084	BPR6EY	6427	.032
	L4 1.6L		<b>BKR6E-11</b>	<b>2756</b>	FR6BHX-S	95159	BKR6EIX-11	3764	BKR6EGP	7092	BKR6E-11	2756	.044
Leganza													
2002-99	L4 2.2L		BKR6EK	2288	FR6BHX-S	95159	BKR6EIX	6418	BKR6EGP	7092	BKR6E	6962	.032
Nubira													
2002-99	L4 2.0L		BKR6ES-11	5553	FR6BHX-S	95159	BKR6EIX-11	3764	BKR6EGP	7092	BKR6E-11	2756	.044
<b>DAIHATSU</b>													
Charade													
1992-89	L3 1.0L		<b>BPR5ES-11</b>	<b>7634</b>			BPR5EIX-11	2115	BPR5EGP	7082	BPR5EY-11	6937	.039
	L4 1.3L		<b>BKR6E-11</b>	<b>2756</b>			BKR6EIX-11	3764	BKR6EGP	7092	BKR6E-11	2756	.039
1988	L3 1.0L		<b>BPR5ES-11</b>	<b>7634</b>			BPR5EIX-11	2115	BPR5EGP	7082	BPR5EY-11	6937	.039
Rocky													
1992-90	L4 1.6L		<b>BKR6E-11</b>	<b>2756</b>			BKR6EIX-11	3764	BKR6EGP	7092	BKR6E-11	2756	.044
<b>DODGE</b>													
600													
1988-86	L4 2.2L		GR4	2635			GR4IX	97382	GR4GP	2763	GR4	2635	.035
	L4 2.5L		GR4	2635			GR4IX	97382	GR4GP	2763	GR4	2635	.035
1985	L4 2.2L		GR4	2635			GR4IX	97382	GR4GP	2763	GR4	2635	.035
	L4 2.6L		<b>BPR5ES-11</b>	<b>7634</b>			BPR5EIX-11	2115	BPR5EGP	7082	BPR5EY-11	6937	.040
2000 GTX													
1990-89	L4 2.0L		<b>BPR6ES-11</b>	<b>7133</b>			BPR6EIX-11	3903	BPR6EGP	7084	BPR6EY-11	6261	.044
Aries													
1989-86	L4 2.2L		GR4	2635			GR4IX	97382	GR4GP	2763	GR4	2635	.035
	L4 2.5L		GR4	2635			GR4IX	97382	GR4GP	2763	GR4	2635	.035
1985	L4 2.2L		GR4	2635			GR4IX	97382	GR4GP	2763	GR4	2635	.035
	L4 2.6L		<b>BPR5ES-11</b>	<b>7634</b>			BPR5EIX-11	2115	BPR5EGP	7082	BPR5EY-11	6937	.040
Avenger													
2014-11	L4 2.4L	Eng Desg ED3, Non-PZEV Eng.	<b>ZFR5F-11</b>	<b>2262</b>	FR5AHX	95839	ZFR5FIX-11	2477	ZFR5FGP	7098	ZFR5F-11	2262	.044
		PZEV, Eng Desg EDG	<b>ZFR5AP</b>	<b>92041</b>	FR5AHX-E	92375	ZFR5FIX-E	95332	ZFR5FGP-8E	92459			.032
	V6 3.6L		SILZKR7B11	9723	LKR7BHX	94705	LKR7DIX-11S	93175	LKR7BGP-S	97390			.044
2010-08	L4 2.4L	Eng Desg ED3, Non-PZEV Eng.	<b>ZFR5F-11</b>	<b>2262</b>	FR5AHX	95839	ZFR5FIX-11	2477	ZFR5FGP	7098	ZFR5F-11	2262	.044
		PZEV, Eng Desg EDG	<b>ZFR5AP</b>	<b>92041</b>	FR5AHX-E	92375	ZFR5FIX-E	95332	ZFR5FGP-8E	92459			.032
	V6 2.7L		LZTR5A-13	4306			LZTR5AIX-13	2314	LZTR5AGP	3381	LZTR5A-13	4306	.050
	V6 3.5L		<b>ZFR5LP-13G</b>	<b>7781</b>			ZFR5FIX-11E	96807	ZFR5FGP-E	94407			.052
2000	V6 2.5L		<b>PFR5G-11</b>	<b>2647</b>	FR5AHX	95839	BKR5EIX-11	5464	BKR5EGP	7090	BKR5E-11	6953	.044
1999-97	L4 2.0L		BKR6E-11	2756	FR6BHX-S	95159	BKR6EIX-11	3764	BKR6EGP	7092	BKR6E-11	2756	.050
	L4 2.5L		<b>PFR5G-11</b>	<b>2647</b>	FR5AHX	95839	BKR5EIX-11	5464	BKR5EGP	7090	BKR5E-11	6953	.044
1996-95	L4 2.0L		BKR6E-11	2756			BKR6EIX-11	3764	BKR6EGP	7092	BKR6E-11	2756	.050
	V6 2.5L		<b>PFR5G-11</b>	<b>2647</b>			BKR5EIX-11	5464	BKR5EGP	7090	BKR5E-11	6953	.044
<b>B150</b>													
1994-92	V6 3.9L		FR4	5155			BKR4EIX	5693	FR4GP	2685	FR4	5155	.035

**Bold denotes NGK OE Manufacturer and/or OE Service Part**  
NOT BOLD denotes OE Equivalent Part

**Le texte en gras désigne une pièce d'équipement originale du manufacturier NGK et/ou pièce d'équipement originale de service**  
Le texte non en gras désigne une pièce d'équipement originale équivalente

Note: Due to different operating or engine conditions, alternate heat range plugs may be required.

Note: En raison de différences au niveau du fonctionnement ou des conditions du moteur, d'autres types de bougies avec variation de chaleur peuvent être nécessaires



Year	Cyl. L	Notes	Original Equipment		Ruthenium HX		Iridium IX		G-Power		V-Power		Gap
			Part	Stock	Part	Stock	Part	Stock	Part	Stock	Part	Stock	
<b>DODGE (Cont'd)</b>													
<b>B150 (Cont'd)</b>													
1994-92	V8 5.2L		FR4	5155			BKR4EIX	5693	FR4GP	2685	FR4	5155	.035
1991-88	V6 3.9L		GR4	2635			GR4IX	97382	GR4GP	2763	GR4	2635	.035
	V8 5.2L		GR4	2635			GR4IX	97382	GR4GP	2763	GR4	2635	.035
1987-85	L6 3.7L		UR4	6630			UR4IX	7401	UR4GP	2869	UR4	6630	.035
	V8 5.2L		GR4	2635			GR4IX	97382	GR4GP	2763	GR4	2635	.035
<b>B250</b>													
1994-93	V6 3.9L		FR4	5155			BKR4EIX	5693	FR4GP	2685	FR4	5155	.035
	V8 5.2L		FR4	5155			BKR4EIX	5693	FR4GP	2685	FR4	5155	.035
	V8 5.9L		FR4	5155			BKR4EIX	5693	FR4GP	2685	FR4	5155	.035
1992	V6 3.9L		FR4	5155			BKR4EIX	5693	FR4GP	2685	FR4	5155	.035
	V8 5.2L		FR4	5155			BKR4EIX	5693	FR4GP	2685	FR4	5155	.035
	V8 5.9L		GR4	2635			GR4IX	97382	GR4GP	2763	GR4	2635	.035
1991-88	V6 3.9L		GR4	2635			GR4IX	97382	GR4GP	2763	GR4	2635	.035
	V8 5.2L		GR4	2635			GR4IX	97382	GR4GP	2763	GR4	2635	.035
	V8 5.9L		GR4	2635			GR4IX	97382	GR4GP	2763	GR4	2635	.035
1987	L6 3.7L		UR4	6630			UR4IX	7401	UR4GP	2869	UR4	6630	.035
	V8 5.2L		GR4	2635			GR4IX	97382	GR4GP	2763	GR4	2635	.035
	V8 5.9L	Vin W	GR4	2635			GR4IX	97382	GR4GP	2763	GR4	2635	.035
1986-85	L6 3.7L		UR4	6630			UR4IX	7401	UR4GP	2869	UR4	6630	.035
	V8 5.2L		GR4	2635			GR4IX	97382	GR4GP	2763	GR4	2635	.035
	V8 5.9L		GR4	2635			GR4IX	97382	GR4GP	2763	GR4	2635	.035
<b>B350</b>													
1994-93	V8 5.2L		FR4	5155			BKR4EIX	5693	FR4GP	2685	FR4	5155	.035
	V8 5.9L		FR4	5155			BKR4EIX	5693	FR4GP	2685	FR4	5155	.035
1992	V8 5.2L		FR4	5155			BKR4EIX	5693	FR4GP	2685	FR4	5155	.035
	V8 5.9L		GR4	2635			GR4IX	97382	GR4GP	2763	GR4	2635	.035
1991-85	V8 5.2L		GR4	2635			GR4IX	97382	GR4GP	2763	GR4	2635	.035
	V8 5.9L		GR4	2635			GR4IX	97382	GR4GP	2763	GR4	2635	.035
<b>B1500</b>													
1998	V6 3.9L		ZFR6F-11	4291	FR6AHX-S	94279	ZFR6FIX-11	6441	ZFR6FGP	7100	ZFR6F-11	4291	.040
	V8 5.2L		ZFR6F-11	4291	FR6AHX-S	94279	ZFR6FIX-11	6441	ZFR6FGP	7100	ZFR6F-11	4291	.040
	V8 5.9L		ZFR6F-11	4291	FR6AHX-S	94279	ZFR6FIX-11	6441	ZFR6FGP	7100	ZFR6F-11	4291	.040
1997	V6 3.9L		ZFR6F-11	4291	FR6AHX-S	94279	ZFR6FIX-11	6441	ZFR6FGP	7100	ZFR6F-11	4291	.040
	V8 5.2L		ZFR6F-11	4291	FR6AHX-S	94279	ZFR6FIX-11	6441	ZFR6FGP	7100	ZFR6F-11	4291	.040
1996	V6 3.9L		BKR5E	7938			BKR5EIX	6341	BKR5EGP	7090	BKR5E	7938	.035
	V8 5.2L		BKR5E	7938			BKR5EIX	6341	BKR5EGP	7090	BKR5E	7938	.035
1995	V6 3.9L		FR4	5155			BKR4EIX	5693	FR4GP	2685	FR4	5155	.035
	V8 5.2L		FR4	5155			BKR4EIX	5693	FR4GP	2685	FR4	5155	.035
<b>B2500</b>													
1998	V8 5.2L		ZFR6F-11	4291	FR6AHX-S	94279	ZFR6FIX-11	6441	ZFR6FGP	7100	ZFR6F-11	4291	.040
	V8 5.9L		ZFR6F-11	4291	FR6AHX-S	94279	ZFR6FIX-11	6441	ZFR6FGP	7100	ZFR6F-11	4291	.040
1997	V6 3.9L		ZFR6F-11	4291	FR6AHX-S	94279	ZFR6FIX-11	6441	ZFR6FGP	7100	ZFR6F-11	4291	.040
	V8 5.2L		ZFR6F-11	4291	FR6AHX-S	94279	ZFR6FIX-11	6441	ZFR6FGP	7100	ZFR6F-11	4291	.040
	V8 5.9L		BKR5E	7938			BKR5EIX	6341	BKR5EGP	7090	BKR5E	7938	.035
1996	V6 3.9L		BKR5E	7938			BKR5EIX	6341	BKR5EGP	7090	BKR5E	7938	.035
	V8 5.2L		BKR5E	7938			BKR5EIX	6341	BKR5EGP	7090	BKR5E	7938	.035
	V8 5.9L		BKR5E	7938			BKR5EIX	6341	BKR5EGP	7090	BKR5E	7938	.035
1995	V6 3.9L		FR4	5155			BKR4EIX	5693	FR4GP	2685	FR4	5155	.035
	V8 5.2L		FR4	5155			BKR4EIX	5693	FR4GP	2685	FR4	5155	.035
	V8 5.9L		FR4	5155			BKR4EIX	5693	FR4GP	2685	FR4	5155	.035
<b>B3500</b>													
1998	V8 5.2L		ZFR6F-11	4291	FR6AHX-S	94279	ZFR6FIX-11	6441	ZFR6FGP	7100	ZFR6F-11	4291	.040
	V8 5.9L		ZFR6F-11	4291	FR6AHX-S	94279	ZFR6FIX-11	6441	ZFR6FGP	7100	ZFR6F-11	4291	.040
1997	V8 5.2L		ZFR6F-11	4291	FR6AHX-S	94279	ZFR6FIX-11	6441	ZFR6FGP	7100	ZFR6F-11	4291	.040
	V8 5.9L		BKR5E	7938			BKR5EIX	6341	BKR5EGP	7090	BKR5E	7938	.035
1996	V8 5.2L		BKR5E	7938			BKR5EIX	6341	BKR5EGP	7090	BKR5E	7938	.035
	V8 5.9L		BKR5E	7938			BKR5EIX	6341	BKR5EGP	7090	BKR5E	7938	.035



Year	Cyl. L	Notes	Original Equipment		Ruthenium HX		Iridium IX		G-Power		V-Power		Gap
			Part	Stock	Part	Stock	Part	Stock	Part	Stock	Part	Stock	
<b>DODGE (Cont'd)</b>													
<b>B3500 (Cont'd)</b>													
1995	V8 5.2L		FR4	5155			BKR4EIX	5693	FR4GP	2685	FR4	5155	.035
	V8 5.9L		FR4	5155			BKR4EIX	5693	FR4GP	2685	FR4	5155	.035
<b>Caliber</b>													
2012	L4 2.0L		<b>ZFR5F-11</b>	<b>2262</b>	FR5AHX	95839	ZFR5FIX-11	2477	ZFR5FGP	7098	ZFR5F-11	2262	.044
2011	L4 2.0L		<b>ZFR5F-11</b>	<b>2262</b>	FR5AHX	95839	ZFR5FIX-11	2477	ZFR5FGP	7098	ZFR5F-11	2262	.044
	L4 2.4L		<b>ZFR5F-11</b>	<b>2262</b>	FR5AHX	95839	ZFR5FIX-11	2477	ZFR5FGP	7098	ZFR5F-11	2262	.044
2010	L4 2.0L		<b>ZFR5F-11</b>	<b>2262</b>	FR5AHX	95839	ZFR5FIX-11	2477	ZFR5FGP	7098	ZFR5F-11	2262	.044
	L4 2.4L	Eng Desg ED3, Non-PZEV Eng. PZEV, Eng Desg EDG	<b>ZFR5F-11</b> <b>ZFR5AP</b>	<b>2262</b> <b>92041</b>	FR5AHX FR5AHX-E	95839 92375	ZFR5FIX-11 ZFR5FIX-E	2477 95332	ZFR5FGP ZFR5FGP-8E	7098 92459	ZFR5F-11	2262	.032
2009	L4 1.8L		<b>ZFR5F-11</b>	<b>2262</b>	FR5AHX	95839	ZFR5FIX-11	2477	ZFR5FGP	7098	ZFR5F-11	2262	.044
	L4 2.0L		<b>ZFR5F-11</b>	<b>2262</b>	FR5AHX	95839	ZFR5FIX-11	2477	ZFR5FGP	7098	ZFR5F-11	2262	.044
	L4 2.4L	Naturally Aspirated, Eng Desg ED3, Non-PZEV Eng. PZEV, Naturally Aspirated, Eng Desg EDG	<b>ZFR5F-11</b> <b>ZFR5AP</b>	<b>2262</b> <b>92041</b>	FR5AHX FR5AHX-E	95839 92375	ZFR5FIX-11 ZFR5FIX-E	2477 95332	ZFR5FGP ZFR5FGP-8E	7098 92459	ZFR5F-11	2262	.032
		Turbo	<b>ZFR5AP</b>	<b>92041</b>	FR5BHX	96457	ZFR5FIX-E	95332	ZFR5FGP-8E	92459			.032
2008	L4 1.8L		<b>ZFR5F-11</b>	<b>2262</b>	FR5AHX	95839	ZFR5FIX-11	2477	ZFR5FGP	7098	ZFR5F-11	2262	.044
	L4 2.0L		<b>ZFR5F-11</b>	<b>2262</b>	FR5AHX	95839	ZFR5FIX-11	2477	ZFR5FGP	7098	ZFR5F-11	2262	.044
	L4 2.4L	Naturally Aspirated, Non-PZEV Eng. Turbo	<b>ZFR5F-11</b> <b>ZFR5AP</b>	<b>2262</b> <b>92041</b>	FR5AHX FR5BHX	95839 96457	ZFR5FIX-11 ZFR5FIX-E	2477 95332	ZFR5FGP ZFR5FGP-8E	7098 92459	ZFR5F-11	2262	.032
			<b>ZFR5AP</b>	<b>92041</b>	FR5BHX	96457	ZFR5FIX-E	95332	ZFR5FGP-8E	92459			.032
2007	L4 1.8L		<b>ZFR5F-11</b>	<b>2262</b>	FR5AHX	95839	ZFR5FIX-11	2477	ZFR5FGP	7098	ZFR5F-11	2262	.044
	L4 2.0L		<b>ZFR5F-11</b>	<b>2262</b>	FR5AHX	95839	ZFR5FIX-11	2477	ZFR5FGP	7098	ZFR5F-11	2262	.044
	L4 2.4L		<b>ZFR5F-11</b>	<b>2262</b>	FR5AHX	95839	ZFR5FIX-11	2477	ZFR5FGP	7098	ZFR5F-11	2262	.044
<b>Caravan</b>													
2007-01	L4 2.4L		<b>LZTR4A-11</b>	<b>5306</b>			LZTR4AIX-11	2313	LZTR4AGP	5017	LZTR4A-11	5306	.044
	V6 3.3L		PLZTR5A-13	4998			LZTR5AIX-13	2314	LZTR5AGP	3381	LZTR5A-13	4306	.050
2000	L4 2.4L		FR45	3686					FR45GP	3072	FR45	3686	.050
	V6 3.0L		BPR5ES-11	7634			BPR5EIX-11	2115	BPR5EGP	7082	BPR5EY-11	6937	.044
	V6 3.3L		GR45GP	3142					GR45GP	3142	GR45	4268	.050
1999-96	L4 2.4L		FR45	3686					FR45GP	3072	FR45	3686	.050
	V6 3.0L		BPR5ES-11	7634			BPR5EIX-11	2115	BPR5EGP	7082	BPR5EY-11	6937	.044
	V6 3.3L		GR45GP	3142					GR45GP	3142	GR45	4268	.050
	V6 3.8L		GR45GP	3142					GR45GP	3142	GR45	4268	.050
1995-93	L4 2.5L		GR4	2635			GR4IX	97382	GR4GP	2763	GR4	2635	.035
	V6 3.0L		BPR5ES-11	7634			BPR5EIX-11	2115	BPR5EGP	7082	BPR5EY-11	6937	.044
	V6 3.3L		GR45	4268					GR45GP	3142	GR45	4268	.050
1992-90	L4 2.5L		GR4	2635			GR4IX	97382	GR4GP	2763	GR4	2635	.035
	V6 3.0L		<b>BPR5ES-11</b>	<b>7634</b>			BPR5EIX-11	2115	BPR5EGP	7082	BPR5EY-11	6937	.044
	V6 3.3L		GR45	4268					GR45GP	3142	GR45	4268	.050
1989-88	L4 2.5L		GR4	2635			GR4IX	97382	GR4GP	2763	GR4	2635	.035
	V6 3.0L		<b>BPR5ES-11</b>	<b>7634</b>			BPR5EIX-11	2115	BPR5EGP	7082	BPR5EY-11	6937	.044
1987	L4 2.2L		GR4	2635			GR4IX	97382	GR4GP	2763	GR4	2635	.035
	L4 2.6L		<b>BPR5ES-11</b>	<b>7634</b>			BPR5EIX-11	2115	BPR5EGP	7082	BPR5EY-11	6937	.040
	V6 3.0L		<b>BPR5ES-11</b>	<b>7634</b>			BPR5EIX-11	2115	BPR5EGP	7082	BPR5EY-11	6937	.044
1986-85	L4 2.2L		GR4	2635			GR4IX	97382	GR4GP	2763	GR4	2635	.035
	L4 2.6L		<b>BPR5ES-11</b>	<b>7634</b>			BPR5EIX-11	2115	BPR5EGP	7082	BPR5EY-11	6937	.040
<b>Challenger</b>													
2017-15	V6 3.6L		SILZKR7B11	9723	LKR7BHX	94705	LKR7DIX-11S	93175	LKR7BGP-S	97390			.044
	V8 5.7L	Dual Plug; 16 Req'd	<b>LZFR5CI-11</b>	<b>92145</b>	LFR5AHX	96355	LFR5AIX-11	4469	LFR5AGP	5018			.044
	V8 6.2L	Dual Plug; 16 Req'd	SILFR6A	7913	LFR6BHX	93420	LFR6AIX	93893	LFR6CGP	1483			.032
	V8 6.4L	Dual Plug; 16 Req'd	<b>LZTR6AP11EG</b>	<b>97408</b>									.044
2014	V6 3.6L		SILZKR7B11	9723	LKR7BHX	94705	LKR7DIX-11S	93175	LKR7BGP-S	97390			.044
	V8 5.7L	Dual Plug; 16 Req'd	<b>LZFR5CI-11</b>	<b>92145</b>	LFR5AHX	96355	LFR5AIX-11	4469	LFR5AGP	5018			.044
	V8 6.4L	Dual Plug; 16 Req'd	<b>LZTR6AP11EG</b>	<b>97408</b>									.044

**Bold denotes NGK OE Manufacturer and/or OE Service Part**  
NOT BOLD denotes OE Equivalent Part

**Le texte en gras désigne une pièce d'équipement originale du manufacturier NGK et/ou pièce d'équipement originale de service**  
Le texte non en gras désigne une pièce d'équipement originale équivalente

Note: Due to different operating or engine conditions, alternate heat range plugs may be required.

Note: En raison de différences au niveau du fonctionnement ou des conditions du moteur, d'autres types de bougies avec variation de chaleur peuvent être nécessaires





Year	Cyl. L	Notes	Original Equipment		Ruthenium HX		Iridium IX		G-Power		V-Power		Gap
			Part	Stock	Part	Stock	Part	Stock	Part	Stock	Part	Stock	
<b>DODGE (Cont'd)</b>													
<b>Challenger (Cont'd)</b>													
2013-11	V6 3.6L		SILZKR7B11	9723	LKR7BHX	94705	LKR7DIX-11S	93175	LKR7BGP-S	97390			.044
	V8 5.7L	Dual Plug; 16 Req'd	<b>LZFR5C-11</b>	<b>92174</b>	LFR5AHX	96355	LFR5AIX-11	4469	LFR5AGP	5018			.044
	V8 6.4L	Dual Plug; 16 Req'd	<b>LZTR6AP11EG</b>	<b>97408</b>									.044
2010-09	V6 3.5L		<b>ZFR5LP-13G</b>	<b>7781</b>			ZFR5FIX-11E	96807	ZFR5FGP-E	94407			.052
	V8 5.7L	Dual Plug; 16 Req'd	<b>LZFR5C-11</b>	<b>92174</b>	LFR5AHX	96355	LFR5AIX-11	4469	LFR5AGP	5018			.044
	V8 6.1L	Dual Plug; 16 Req'd	<b>PLZTR5A-13</b>	<b>4998</b>			LZTR5AIX-13	2314	LZTR5AGP	3381	LZTR5A-13	4306	.052
2008	V8 6.1L	Dual Plug; 16 Req'd	<b>PLZTR5A-13</b>	<b>4998</b>			LZTR5AIX-13	2314	LZTR5AGP	3381	LZTR5A-13	4306	.052
<b>Charger</b>													
2017-15	V6 3.6L		SILZKR7B11	9723	LKR7BHX	94705	LKR7DIX-11S	93175	LKR7BGP-S	97390			.044
	V8 5.7L	Dual Plug; 16 Req'd	<b>LZFR5CI-11</b>	<b>92145</b>	LFR5AHX	96355	LFR5AIX-11	4469	LFR5AGP	5018			.044
	V8 6.2L	Dual Plug; 16 Req'd	SILFR6A	7913	LFR6BHX	93420	LFR6AIX	93893	LFR6CGP	1483			.032
	V8 6.4L	Dual Plug; 16 Req'd	<b>LZTR6AP11EG</b>	<b>97408</b>									.044
2014	V6 3.6L		SILZKR7B11	9723	LKR7BHX	94705	LKR7DIX-11S	93175	LKR7BGP-S	97390			.044
	V8 5.7L	Dual Plug; 16 Req'd	<b>LZFR5CI-11</b>	<b>92145</b>	LFR5AHX	96355	LFR5AIX-11	4469	LFR5AGP	5018			.044
	V8 6.4L	Dual Plug; 16 Req'd	<b>LZTR6AP11EG</b>	<b>97408</b>									.044
2013-12	V6 3.6L		SILZKR7B11	9723	LKR7BHX	94705	LKR7DIX-11S	93175	LKR7BGP-S	97390			.044
	V8 5.7L	Dual Plug; 16 Req'd	<b>LZFR5C-11</b>	<b>92174</b>	LFR5AHX	96355	LFR5AIX-11	4469	LFR5AGP	5018			.044
	V8 6.4L	Dual Plug; 16 Req'd	<b>LZTR6AP11EG</b>	<b>97408</b>									.044
2011	V6 3.6L		SILZKR7B11	9723	LKR7BHX	94705	LKR7DIX-11S	93175	LKR7BGP-S	97390			.044
	V8 5.7L	Dual Plug; 16 Req'd	<b>LZFR5C-11</b>	<b>92174</b>	LFR5AHX	96355	LFR5AIX-11	4469	LFR5AGP	5018			.044
2010-09	V6 2.7L		PLZTR5A-13	4998			LZTR5AIX-13	2314	LZTR5AGP	3381	LZTR5A-13	4306	.050
	V6 3.5L		<b>ZFR5LP-13G</b>	<b>7781</b>			ZFR5FIX-11E	96807	ZFR5FGP-E	94407			.052
	V8 5.7L	Dual Plug; 16 Req'd	<b>LZFR5C-11</b>	<b>92174</b>	LFR5AHX	96355	LFR5AIX-11	4469	LFR5AGP	5018			.044
	V8 6.1L	Dual Plug; 16 Req'd	<b>PLZTR5A-13</b>	<b>4998</b>			LZTR5AIX-13	2314	LZTR5AGP	3381	LZTR5A-13	4306	.052
2008-06	V6 2.7L		PLZTR5A-13	4998			LZTR5AIX-13	2314	LZTR5AGP	3381	LZTR5A-13	4306	.050
	V6 3.5L		<b>ZFR5LP-13G</b>	<b>7781</b>			ZFR5FIX-11E	96807	ZFR5FGP-E	94407			.052
	V8 5.7L	Dual Plug; 16 Req'd	LZTR4A-11	5306			LZTR4AIX-11	2313	LZTR4AGP	5017	LZTR4A-11	5306	.044
	V8 6.1L	Dual Plug; 16 Req'd	<b>PLZTR5A-13</b>	<b>4998</b>			LZTR5AIX-13	2314	LZTR5AGP	3381	LZTR5A-13	4306	.052
1987-85	L4 2.2L		GR4	2635			GR4IX	97382	GR4GP	2763	GR4	2635	.035
<b>Colt</b>													
1995	L4 1.5L		<b>BPR5ES-11</b>	<b>7634</b>			BPR5EIX-11	2115	BPR5EGP	7082	BPR5EY-11	6937	.044
1994-93	L4 1.5L		<b>BPR5ES-11</b>	<b>7634</b>			BPR5EIX-11	2115	BPR5EGP	7082	BPR5EY-11	6937	.044
	L4 1.8L		<b>BKR5E-11</b>	<b>6953</b>			BKR5EIX-11	5464	BKR5EGP	7090	BKR5E-11	6953	.044
	L4 2.4L		<b>BKR6E-11</b>	<b>2756</b>			BKR6EIX-11	3764	BKR6EGP	7092	BKR6E-11	2756	.044
1992	L4 1.5L		<b>BPR5ES-11</b>	<b>7634</b>			BPR5EIX-11	2115	BPR5EGP	7082	BPR5EY-11	6937	.044
	L4 1.8L	Vin D	ZFR6F-11	4291			ZFR6FIX-11	6441	ZFR6FGP	7100	ZFR6F-11	4291	.045
1991	L4 1.5L	Vin A	<b>BPR5ES-11</b>	<b>7634</b>			BPR5EIX-11	2115	BPR5EGP	7082	BPR5EY-11	6937	.044
		Vin K	<b>BPR5ES-11</b>	<b>7634</b>			BPR5EIX-11	2115	BPR5EGP	7082	BPR5EY-11	6937	.045
	L4 2.0L		<b>BPR6ES-11</b>	<b>7133</b>			BPR6EIX-11	3903	BPR6EGP	7084	BPR6EY-11	6261	.044
1990	L4 1.5L		<b>BPR6ES-11</b>	<b>7133</b>			BPR6EIX-11	3903	BPR6EGP	7084	BPR6EY-11	6261	.044
	L4 1.6L	Naturally Aspirated	<b>BPR6ES-11</b>	<b>7133</b>			BPR6EIX-11	3903	BPR6EGP	7084	BPR6EY-11	6261	.044
		Turbo	<b>BPR7ES-11</b>	<b>7226</b>			BPR7EIX	4055					.044
	L4 1.8L		<b>BPR6ES-11</b>	<b>7133</b>			BPR6EIX-11	3903	BPR6EGP	7084	BPR6EY-11	6261	.044
1989	L4 2.0L		<b>BPR6ES-11</b>	<b>7133</b>			BPR6EIX-11	3903	BPR6EGP	7084	BPR6EY-11	6261	.044
	L4 1.5L		<b>BPR6ES-11</b>	<b>7133</b>			BPR6EIX-11	3903	BPR6EGP	7084	BPR6EY-11	6261	.044
	L4 1.6L	Vin F	<b>BPR7ES-11</b>	<b>7226</b>			BPR7EIX	4055					.044
		Vin Y	<b>BPR6ES-11</b>	<b>7133</b>			BPR6EIX-11	3903	BPR6EGP	7084	BPR6EY-11	6261	.044
		Vin Z	<b>BPR6ES-11</b>	<b>7133</b>			BPR6EIX-11	3903	BPR6EGP	7084	BPR6EY-11	6261	.044
	L4 1.8L		<b>BPR6ES-11</b>	<b>7133</b>			BPR6EIX-11	3903	BPR6EGP	7084	BPR6EY-11	6261	.044
1988-85	L4 2.0L		<b>BPR6ES-11</b>	<b>7133</b>			BPR6EIX-11	3903	BPR6EGP	7084	BPR6EY-11	6261	.044
	L4 1.5L		<b>BPR6ES-11</b>	<b>7133</b>			BPR6EIX-11	3903	BPR6EGP	7084	BPR6EY-11	6261	.044
	L4 1.6L		<b>BPR7ES-11</b>	<b>7226</b>			BPR7EIX	4055					.044
	L4 2.0L		<b>BPR6ES-11</b>	<b>7133</b>			BPR6EIX-11	3903	BPR6EGP	7084	BPR6EY-11	6261	.044
<b>Conquest</b>													
1986-85	L4 2.6L		<b>BPR6ES-11</b>	<b>7133</b>			BPR6EIX-11	3903	BPR6EGP	7084	BPR6EY-11	6261	.044
<b>D100</b>													
1989	V6 3.9L		GR4	2635			GR4IX	97382	GR4GP	2763	GR4	2635	.035





Year	Cyl. L	Notes	Original Equipment		Ruthenium HX		Iridium IX		G-Power		V-Power		Gap
			Part	Stock	Part	Stock	Part	Stock	Part	Stock	Part	Stock	
<b>DODGE (Cont'd)</b>													
<b>D100 (Cont'd)</b>													
1989	V8 5.2L		GR4	2635			GR4IX	97382	GR4GP	2763	GR4	2635	.035
1988	V6 3.9L		GR4	2635			GR4IX	97382	GR4GP	2763	GR4	2635	.035
	V8 5.2L		GR4	2635			GR4IX	97382	GR4GP	2763	GR4	2635	.035
	V8 5.9L		GR4	2635			GR4IX	97382	GR4GP	2763	GR4	2635	.035
1987	L6 3.7L		UR4	6630			UR4IX	7401	UR4GP	2869	UR4	6630	.035
	V8 5.2L		GR4	2635			GR4IX	97382	GR4GP	2763	GR4	2635	.035
	V8 5.9L	Vin W	GR4	2635			GR4IX	97382	GR4GP	2763	GR4	2635	.035
1986-85	L6 3.7L		UR4	6630			UR4IX	7401	UR4GP	2869	UR4	6630	.035
	V8 5.2L		GR4	2635			GR4IX	97382	GR4GP	2763	GR4	2635	.035
	V8 5.9L		GR4	2635			GR4IX	97382	GR4GP	2763	GR4	2635	.035
<b>D150</b>													
1993	V6 3.9L		FR4	5155			BKR4EIX	5693	FR4GP	2685	FR4	5155	.035
	V8 5.2L		FR4	5155			BKR4EIX	5693	FR4GP	2685	FR4	5155	.035
	V8 5.9L		FR4	5155			BKR4EIX	5693	FR4GP	2685	FR4	5155	.035
1992	V6 3.9L		FR4	5155			BKR4EIX	5693	FR4GP	2685	FR4	5155	.035
	V8 5.2L		FR4	5155			BKR4EIX	5693	FR4GP	2685	FR4	5155	.035
1991-88	V6 3.9L		GR4	2635			GR4IX	97382	GR4GP	2763	GR4	2635	.035
	V8 5.2L		GR4	2635			GR4IX	97382	GR4GP	2763	GR4	2635	.035
	V8 5.9L		GR4	2635			GR4IX	97382	GR4GP	2763	GR4	2635	.035
1987-85	L6 3.7L		UR4	6630			UR4IX	7401	UR4GP	2869	UR4	6630	.035
	V8 5.2L		GR4	2635			GR4IX	97382	GR4GP	2763	GR4	2635	.035
	V8 5.9L		GR4	2635			GR4IX	97382	GR4GP	2763	GR4	2635	.035
<b>D250</b>													
1993	V6 3.9L		FR4	5155			BKR4EIX	5693	FR4GP	2685	FR4	5155	.035
	V8 5.2L		FR4	5155			BKR4EIX	5693	FR4GP	2685	FR4	5155	.035
	V8 5.9L	Vin 5	AR6FS	3323									.035
		Vin Z	FR4	5155			BKR4EIX	5693	FR4GP	2685	FR4	5155	.035
1992	V6 3.9L		FR4	5155			BKR4EIX	5693	FR4GP	2685	FR4	5155	.035
	V8 5.2L		FR4	5155			BKR4EIX	5693	FR4GP	2685	FR4	5155	.035
	V8 5.9L		GR4	2635			GR4IX	97382	GR4GP	2763	GR4	2635	.035
1991-89	V6 3.9L		GR4	2635			GR4IX	97382	GR4GP	2763	GR4	2635	.035
	V8 5.2L		GR4	2635			GR4IX	97382	GR4GP	2763	GR4	2635	.035
	V8 5.9L	Vin 5	AR6FS	3323									.035
		Vin Z	GR4	2635			GR4IX	97382	GR4GP	2763	GR4	2635	.035
1988	V6 3.9L		GR4	2635			GR4IX	97382	GR4GP	2763	GR4	2635	.035
	V8 5.2L		GR4	2635			GR4IX	97382	GR4GP	2763	GR4	2635	.035
	V8 5.9L	Vin 1	GR4	2635			GR4IX	97382	GR4GP	2763	GR4	2635	.035
		Vin 5	AR6FS	3323									.035
		Vin W	GR4	2635			GR4IX	97382	GR4GP	2763	GR4	2635	.035
1987	L6 3.7L		UR4	6630			UR4IX	7401	UR4GP	2869	UR4	6630	.035
	V8 5.2L		GR4	2635			GR4IX	97382	GR4GP	2763	GR4	2635	.035
	V8 5.9L	Vin 5	AR6FS	3323									.035
		Vin W	GR4	2635			GR4IX	97382	GR4GP	2763	GR4	2635	.035
1986-85	L6 3.7L		UR4	6630			UR4IX	7401	UR4GP	2869	UR4	6630	.035
	V8 5.2L		GR4	2635			GR4IX	97382	GR4GP	2763	GR4	2635	.035
	V8 5.9L		GR4	2635			GR4IX	97382	GR4GP	2763	GR4	2635	.035
<b>D350</b>													
1993	V8 5.9L	Vin 5	AR6FS	3323									.035
		Vin Z	FR4	5155			BKR4EIX	5693	FR4GP	2685	FR4	5155	.035
1992-89	V8 5.9L	Vin 5	AR6FS	3323									.035
		Vin Z	GR4	2635			GR4IX	97382	GR4GP	2763	GR4	2635	.035
1988	V8 5.9L	Vin 1	GR4	2635			GR4IX	97382	GR4GP	2763	GR4	2635	.035
		Vin 5	AR6FS	3323									.035
1987	V8 5.9L	Vin 1	GR4	2635			GR4IX	97382	GR4GP	2763	GR4	2635	.035
		Vin 5	AR6FS	3323									.035
		Vin W	GR4	2635			GR4IX	97382	GR4GP	2763	GR4	2635	.035
1986-85	V8 5.9L		GR4	2635			GR4IX	97382	GR4GP	2763	GR4	2635	.035

**Bold denotes NGK OE Manufacturer and/or OE Service Part**  
NOT BOLD denotes OE Equivalent Part

**Le texte en gras désigne une pièce d'équipement originale du manufacturier NGK et/ou pièce d'équipement originale de service**  
Le texte non en gras désigne une pièce d'équipement originale équivalente

Note: Due to different operating or engine conditions, alternate heat range plugs may be required.

Note: En raison de différences au niveau du fonctionnement ou des conditions du moteur, d'autres types de bougies avec variation de chaleur peuvent être nécessaires



Year	Cyl. L	Notes	Original Equipment		Ruthenium HX		Iridium IX		G-Power		V-Power		Gap
			Part	Stock	Part	Stock	Part	Stock	Part	Stock	Part	Stock	
<b>DODGE (Cont'd)</b>													
Dakota													
2010-09	V6 3.7L		<b>ZFR6F-11G</b>	<b>6987</b>	FR6BHX-S	95159	ZFR6FIX-11	6441	ZFR6FGP	7100	ZFR6F-11G	6987	.044
	V8 4.7L	Dual Plug; Exhaust Side (8 Req'd)	PLZFR5B13EG	97606			LZFR5AIX-11E	92460	LZFR5AGP-E	90192			.051
		Dual Plug; Intake Side (8 Req'd)	LZFR5C-11	92174			LFR5AIX-11	4469	LFR5AGP	5018			.039
2008	V6 3.7L		<b>ZFR6F-11G</b>	<b>6987</b>	FR6AHX-S	94279	ZFR6FIX-11	6441	ZFR6FGP	7100	ZFR6F-11G	6987	.044
	V8 4.7L	Dual Plug; Exhaust Side (8 Req'd)	PLZFR5B13EG	97606			LZFR5AIX-11E	92460	LZFR5AGP-E	90192			.051
		Dual Plug; Intake Side (8 Req'd)	LZFR5C-11	92174			LFR5AIX-11	4469	LFR5AGP	5018			.039
2007	V6 3.7L		<b>ZFR6F-11G</b>	<b>6987</b>	FR6AHX-S	94279	ZFR6FIX-11	6441	ZFR6FGP	7100	ZFR6F-11G	6987	.044
	V8 4.7L	Magnum, Vin N, w/o High Output Engine	ZFR5F-11	2262	FR5AHX	95839	ZFR5FIX-11	2477	ZFR5FGP	7098	ZFR5F-11	2262	.044
		Magnum, Vin P, w/o High Output Engine	ZFR5F-11	2262	FR5AHX	95839	ZFR5FIX-11	2477	ZFR5FGP	7098	ZFR5F-11	2262	.044
Magnum HO, Vin J, High Output Engine		PFR6T-10G	5542	FR6AHX-S	94279	BKR6EIX-11	3764	BKR6EGP	7092			.040	
2006	V6 3.7L		<b>ZFR6F-11G</b>	<b>6987</b>	FR6AHX-S	94279	ZFR6FIX-11	6441	ZFR6FGP	7100	ZFR6F-11G	6987	.044
	V8 4.7L	Magnum, Vin N, w/o High Output Engine	ZFR5F-11	2262	FR5AHX	95839	ZFR5FIX-11	2477	ZFR5FGP	7098	ZFR5F-11	2262	.044
		Magnum HO, Vin J, High Output Engine	PFR6T-10G	5542	FR6AHX-S	94279	BKR6EIX-11	3764	BKR6EGP	7092			.040
2005	V6 3.7L		<b>ZFR6F-11G</b>	<b>6987</b>	FR6AHX-S	94279	ZFR6FIX-11	6441	ZFR6FGP	7100	ZFR6F-11G	6987	.044
	V8 4.7L	Vin J, High Output Engine	PFR6T-10G	5542	FR6AHX-S	94279	BKR6EIX-11	3764	BKR6EGP	7092			.040
		Vin N, w/o High Output Engine	ZFR5F-11	2262	FR5AHX	95839	ZFR5FIX-11	2477	ZFR5FGP	7098	ZFR5F-11	2262	.044
2004	V6 3.7L		<b>ZFR6F-11G</b>	<b>6987</b>	FR6AHX-S	94279	ZFR6FIX-11	6441	ZFR6FGP	7100	ZFR6F-11G	6987	.044
	V8 4.7L		ZFR5F-11	2262	FR5AHX	95839	ZFR5FIX-11	2477	ZFR5FGP	7098	ZFR5F-11	2262	.044
2003	V6 3.9L		ZFR6F-11	4291	FR6AHX-S	94279	ZFR6FIX-11	6441	ZFR6FGP	7100	ZFR6F-11	4291	.040
	V8 4.7L		ZFR5F-11	2262	FR5AHX	95839	ZFR5FIX-11	2477	ZFR5FGP	7098	ZFR5F-11	2262	.044
	V8 5.9L		ZFR6F-11	4291	FR6AHX-S	94279	ZFR6FIX-11	6441	ZFR6FGP	7100	ZFR6F-11	4291	.040
2002-00	L4 2.5L		<b>ZFR5N</b>	<b>3459</b>							ZFR5N	3459	.036
	V6 3.9L		ZFR6F-11	4291	FR6AHX-S	94279	ZFR6FIX-11	6441	ZFR6FGP	7100	ZFR6F-11	4291	.040
	V8 4.7L		ZFR5F-11	2262	FR5AHX	95839	ZFR5FIX-11	2477	ZFR5FGP	7098	ZFR5F-11	2262	.044
	V8 5.9L		ZFR6F-11	4291	FR6AHX-S	94279	ZFR6FIX-11	6441	ZFR6FGP	7100	ZFR6F-11	4291	.040
1999	L4 2.5L		<b>ZFR5N</b>	<b>3459</b>							ZFR5N	3459	.036
	V6 3.9L		ZFR6F-11	4291	FR6AHX-S	94279	ZFR6FIX-11	6441	ZFR6FGP	7100	ZFR6F-11	4291	.040
	V8 5.2L		ZFR6F-11	4291	FR6AHX-S	94279	ZFR6FIX-11	6441	ZFR6FGP	7100	ZFR6F-11	4291	.040
	V8 5.9L		ZFR6F-11	4291	FR6AHX-S	94279	ZFR6FIX-11	6441	ZFR6FGP	7100	ZFR6F-11	4291	.040
1998	L4 2.5L		ZFR5N	3459							ZFR5N	3459	.035
	V6 3.9L		ZFR6F-11	4291	FR6AHX-S	94279	ZFR6FIX-11	6441	ZFR6FGP	7100	ZFR6F-11	4291	.040
	V8 5.2L		ZFR6F-11	4291	FR6AHX-S	94279	ZFR6FIX-11	6441	ZFR6FGP	7100	ZFR6F-11	4291	.040
	V8 5.9L		ZFR6F-11	4291	FR6AHX-S	94279	ZFR6FIX-11	6441	ZFR6FGP	7100	ZFR6F-11	4291	.040
1997	L4 2.5L		ZFR5N	3459							ZFR5N	3459	.035
	V6 3.9L		ZFR6F-11	4291	FR6AHX-S	94279	ZFR6FIX-11	6441	ZFR6FGP	7100	ZFR6F-11	4291	.040
	V8 5.2L		ZFR6F-11	4291	FR6AHX-S	94279	ZFR6FIX-11	6441	ZFR6FGP	7100	ZFR6F-11	4291	.040
1996	L4 2.5L		ZFR5N	3459							ZFR5N	3459	.035
	V6 3.9L		BKR5E	7938			BKR5EIX	6341	BKR5EGP	7090	BKR5E	7938	.035
	V8 5.2L		BKR5E	7938			BKR5EIX	6341	BKR5EGP	7090	BKR5E	7938	.035
1995-94	L4 2.5L		BPR4ES SOLID	6578			GR4IX	97382	GR4GP	2763	GR4	2635	.035
	V6 3.9L		BKR5E	7938			BKR5EIX	6341	BKR5EGP	7090	BKR5E	7938	.035
	V8 5.2L		BKR5E	7938			BKR5EIX	6341	BKR5EGP	7090	BKR5E	7938	.035
1993-92	L4 2.5L		BPR4ES SOLID	6578			GR4IX	97382	GR4GP	2763	GR4	2635	.035
	V6 3.9L		FR4	5155			BKR4EIX	5693	FR4GP	2685	FR4	5155	.035
	V8 5.2L		FR4	5155			BKR4EIX	5693	FR4GP	2685	FR4	5155	.035
1991-89	L4 2.5L		BPR4ES SOLID	6578			GR4IX	97382	GR4GP	2763	GR4	2635	.035
	V6 3.9L		GR4	2635			GR4IX	97382	GR4GP	2763	GR4	2635	.035
	V8 5.2L		GR4	2635			GR4IX	97382	GR4GP	2763	GR4	2635	.035
1988-87	L4 2.2L		GR4	2635			GR4IX	97382	GR4GP	2763	GR4	2635	.035
	V6 3.9L		GR4	2635			GR4IX	97382	GR4GP	2763	GR4	2635	.035



Year	Cyl. L	Notes	Original Equipment		Ruthenium HX		Iridium IX		G-Power		V-Power		Gap
			Part	Stock	Part	Stock	Part	Stock	Part	Stock	Part	Stock	
<b>DODGE (Cont'd)</b>													
<b>Dart</b>													
2016-13	L4 1.4L		<b>SIKR9A7</b>	<b>93618</b>									.028
	L4 2.0L		LZFR5CI-11	92145	LFR5AHX	96355	LFR5AIX-11	4469	LFR5AGP	5018			.044
	L4 2.4L		LZFR5CI-11	92145	LFR5AHX	96355	LFR5AIX-11	4469	LFR5AGP	5018			.047
<b>Daytona</b>													
1993-92	L4 2.2L		GR4	2635			GR4IX	97382	GR4GP	2763	GR4	2635	.035
	L4 2.5L		GR4	2635			GR4IX	97382	GR4GP	2763	GR4	2635	.035
	V6 3.0L		<b>BPR5ES-11</b>	<b>7634</b>			BPR5EIX-11	2115	BPR5EGP	7082	BPR5EY-11	6937	.044
1991	L4 2.5L		GR4	2635			GR4IX	97382	GR4GP	2763	GR4	2635	.035
	V6 3.0L		<b>BPR5ES-11</b>	<b>7634</b>			BPR5EIX-11	2115	BPR5EGP	7082	BPR5EY-11	6937	.044
1990	L4 2.2L		GR4	2635			GR4IX	97382	GR4GP	2763	GR4	2635	.035
	L4 2.5L		GR4	2635			GR4IX	97382	GR4GP	2763	GR4	2635	.035
	V6 3.0L		<b>BPR5ES-11</b>	<b>7634</b>			BPR5EIX-11	2115	BPR5EGP	7082	BPR5EY-11	6937	.044
1989-86	L4 2.2L		GR4	2635			GR4IX	97382	GR4GP	2763	GR4	2635	.035
	L4 2.5L		GR4	2635			GR4IX	97382	GR4GP	2763	GR4	2635	.035
1985	L4 2.2L		GR4	2635			GR4IX	97382	GR4GP	2763	GR4	2635	.035
<b>Diplomat</b>													
1989-85	V8 5.2L		GR4	2635			GR4IX	97382	GR4GP	2763	GR4	2635	.035
<b>Durango</b>													
2017-16	V6 3.6L		ILZKR7B11	7751	LKR7AHX-S	96358	LKR7DIX-11S	93175	LKR7BGP-S	97390			.040
	V8 5.7L	Dual Plug; 16 Req'd	<b>LZFR5CI-11</b>	<b>92145</b>	LFR5AHX	96355	LFR5AIX-11	4469	LFR5AGP	5018			.044
2015-14	V6 3.6L		SILZKR7B11	9723	LKR7BHX	94705	LKR7DIX-11S	93175	LKR7BGP-S	97390			.044
	V8 5.7L	Dual Plug; 16 Req'd	<b>LZFR5CI-11</b>	<b>92145</b>	LFR5AHX	96355	LFR5AIX-11	4469	LFR5AGP	5018			.044
2013-11	V6 3.6L		SILZKR7B11	9723	LKR7BHX	94705	LKR7DIX-11S	93175	LKR7BGP-S	97390			.044
	V8 5.7L	Dual Plug; 16 Req'd	<b>LZFR5CI-11</b>	<b>92174</b>	LFR5AHX	96355	LFR5AIX-11	4469	LFR5AGP	5018			.044
2009	V6 3.7L		<b>ZFR6F-11G</b>	<b>6987</b>	FR6BHX-S	95159	ZFR6FIX-11	6441	ZFR6FGP	7100	ZFR6F-11G	6987	.044
	V8 4.7L	Dual Plug; Exhaust Side (8 Req'd)	PLZFR5B13EG	97606			LZFR5AIX-11E	92460	LZFR5AGP-E	90192			.051
		Dual Plug; Intake Side (8 Req'd)	LZFR5C-11	92174			LFR5AIX-11	4469	LFR5AGP	5018			.039
	V8 5.7L	ELECTRIC/GAS, Dual Plug; 16 Req'd	<b>PLZFR5B13EG</b>	<b>97606</b>			LZFR5AIX-11E	92460	LZFR5AGP-E	90192			.052
GAS, Dual Plug; 16 Req'd		<b>LZFR5C-11</b>	<b>92174</b>	LFR5AHX	96355	LFR5AIX-11	4469	LFR5AGP	5018			.044	
2008	V6 3.7L		<b>ZFR6F-11G</b>	<b>6987</b>	FR6AHX-S	94279	ZFR6FIX-11	6441	ZFR6FGP	7100	ZFR6F-11G	6987	.044
	V8 4.7L	Dual Plug; Exhaust Side (8 Req'd)	PLZFR5B13EG	97606			LZFR5AIX-11E	92460	LZFR5AGP-E	90192			.051
		Dual Plug; Intake Side (8 Req'd)	LZFR5C-11	92174			LFR5AIX-11	4469	LFR5AGP	5018			.039
	V8 5.7L	Dual Plug; 16 Req'd	LZTR4A-11	5306			LZTR4AIX-11	2313	LZTR4AGP	5017	LZTR4A-11	5306	.044
2007-04	V6 3.7L		<b>ZFR6F-11G</b>	<b>6987</b>	FR6AHX-S	94279	ZFR6FIX-11	6441	ZFR6FGP	7100	ZFR6F-11G	6987	.044
	V8 4.7L		ZFR6F-11G	6987	FR6AHX-S	94279	ZFR6FIX-11	6441	ZFR6FGP	7100	ZFR6F-11G	6987	.044
	V8 5.7L	Dual Plug; 16 Req'd	LZTR4A-11	5306			LZTR4AIX-11	2313	LZTR4AGP	5017	LZTR4A-11	5306	.044
2003-01	V8 4.7L		ZFR6F-11G	6987	FR6AHX-S	94279	ZFR6FIX-11	6441	ZFR6FGP	7100	ZFR6F-11G	6987	.044
	V8 5.9L		ZFR6F-11	4291	FR6AHX-S	94279	ZFR6FIX-11	6441	ZFR6FGP	7100	ZFR6F-11	4291	.040
2000	V8 4.7L		ZFR6F-11G	6987	FR6AHX-S	94279	ZFR6FIX-11	6441	ZFR6FGP	7100	ZFR6F-11G	6987	.044
	V8 5.2L		ZFR6F-11	4291	FR6AHX-S	94279	ZFR6FIX-11	6441	ZFR6FGP	7100	ZFR6F-11	4291	.040
	V8 5.9L		ZFR6F-11	4291	FR6AHX-S	94279	ZFR6FIX-11	6441	ZFR6FGP	7100	ZFR6F-11	4291	.040
1999-98	V6 3.9L		ZFR6F-11	4291	FR6AHX-S	94279	ZFR6FIX-11	6441	ZFR6FGP	7100	ZFR6F-11	4291	.040
	V8 5.2L		ZFR6F-11	4291	FR6AHX-S	94279	ZFR6FIX-11	6441	ZFR6FGP	7100	ZFR6F-11	4291	.040
	V8 5.9L		ZFR6F-11	4291	FR6AHX-S	94279	ZFR6FIX-11	6441	ZFR6FGP	7100	ZFR6F-11	4291	.040
<b>Dynasty</b>													
1993-90	L4 2.5L		GR4	2635			GR4IX	97382	GR4GP	2763	GR4	2635	.035
	V6 3.0L		<b>BPR5ES-11</b>	<b>7634</b>			BPR5EIX-11	2115	BPR5EGP	7082	BPR5EY-11	6937	.044
	V6 3.3L		GR45	4268					GR45GP	3142	GR45	4268	.050
1989-88	L4 2.5L		GR4	2635			GR4IX	97382	GR4GP	2763	GR4	2635	.035
	V6 3.0L		<b>BPR5ES-11</b>	<b>7634</b>			BPR5EIX-11	2115	BPR5EGP	7082	BPR5EY-11	6937	.044
<b>Grand Caravan</b>													
2017-11	V6 3.6L		SILZKR7B11	9723	LKR7BHX	94705	LKR7DIX-11S	93175	LKR7BGP-S	97390			.044
2010-08	V6 3.3L		PLZTR5A-13	4998			LZTR5AIX-13	2314	LZTR5AGP	3381	LZTR5A-13	4306	.050

**Bold denotes NGK OE Manufacturer and/or OE Service Part**  
 NOT BOLD denotes OE Equivalent Part

Note: Due to different operating or engine conditions, alternate heat range plugs may be required.

**Le texte en gras désigne une pièce d'équipement originale du manufacturier NGK et/ou pièce d'équipement originale de service**  
 Le texte non en gras désigne une pièce d'équipement originale équivalente

Note: En raison de différences au niveau du fonctionnement ou des conditions du moteur, d'autres types de bougies avec variation de chaleur peuvent être nécessaires



Year	Cyl. L	Notes	Original Equipment		Ruthenium HX		Iridium IX		G-Power		V-Power		Gap
			Part	Stock	Part	Stock	Part	Stock	Part	Stock	Part	Stock	
<b>DODGE (Cont'd)</b>													
Grand Caravan (Cont'd)													
2010-08	V6 3.8L		PLZTR5A-13	4998			LZTR5AIX-13	2314	LZTR5AGP	3381	LZTR5A-13	4306	.050
	V6 4.0L		<b>ZFR5LP-13G</b>	<b>7781</b>			ZFR5FIX-11E	96807	ZFR5FGP-E	94407			.052
2007-01	V6 3.3L		PLZTR5A-13	4998			LZTR5AIX-13	2314	LZTR5AGP	3381	LZTR5A-13	4306	.050
	V6 3.8L		PLZTR5A-13	4998			LZTR5AIX-13	2314	LZTR5AGP	3381	LZTR5A-13	4306	.050
2000-98	V6 3.0L		BPR5ES-11	7634			BPR5EIX-11	2115	BPR5EGP	7082	BPR5EY-11	6937	.044
	V6 3.3L		GR45GP	3142					GR45GP	3142	GR45	4268	.050
	V6 3.8L		GR45GP	3142					GR45GP	3142	GR45	4268	.050
1997-96	L4 2.4L		FR45	3686					FR45GP	3072	FR45	3686	.050
	V6 3.0L		BPR5ES-11	7634			BPR5EIX-11	2115	BPR5EGP	7082	BPR5EY-11	6937	.044
	V6 3.3L		GR45GP	3142					GR45GP	3142	GR45	4268	.050
	V6 3.8L		GR45GP	3142					GR45GP	3142	GR45	4268	.050
1995-94	V6 3.0L		BPR5ES-11	7634			BPR5EIX-11	2115	BPR5EGP	7082	BPR5EY-11	6937	.044
	V6 3.3L		GR45	4268					GR45GP	3142	GR45	4268	.050
	V6 3.8L		GR45	4268					GR45GP	3142	GR45	4268	.050
1993	V6 3.0L		BPR5ES-11	7634			BPR5EIX-11	2115	BPR5EGP	7082	BPR5EY-11	6937	.044
	V6 3.3L		GR45	4268					GR45GP	3142	GR45	4268	.050
1992	V6 3.0L		<b>BPR5ES-11</b>	<b>7634</b>			BPR5EIX-11	2115	BPR5EGP	7082	BPR5EY-11	6937	.044
	V6 3.3L		GR45	4268					GR45GP	3142	GR45	4268	.050
1991-90	V6 3.3L		GR45	4268					GR45GP	3142	GR45	4268	.050
1989-87	L4 2.5L		GR4	2635			GR4IX	97382	GR4GP	2763	GR4	2635	.035
	V6 3.0L		<b>BPR5ES-11</b>	<b>7634</b>			BPR5EIX-11	2115	BPR5EGP	7082	BPR5EY-11	6937	.044
<b>Intrepid</b>													
2004-03	V6 2.7L		LZTR5A-13	4306			LZTR5AIX-13	2314	LZTR5AGP	3381	LZTR5A-13	4306	.050
	V6 3.5L		<b>ZFR5LP-13G</b>	<b>7781</b>			ZFR5FIX-11E	96807	ZFR5FGP-E	94407			.052
2002	V6 2.7L		LZTR5A-13	4306			LZTR5AIX-13	2314	LZTR5AGP	3381	LZTR5A-13	4306	.050
	V6 3.5L		<b>ZFR5LP-13G</b>	<b>7781</b>			ZFR5FIX-11E	96807	ZFR5FGP-E	94407			.050
2001-00	V6 2.7L		LZTR5A-13	4306			LZTR5AIX-13	2314	LZTR5AGP	3381	LZTR5A-13	4306	.050
	V6 3.2L		ZFR5LP-13G	7781			ZFR5FIX-11E	96807	ZFR5FGP-E	94407			.050
	V6 3.5L		ZFR5LP-13G	7781			ZFR5FIX-11E	96807	ZFR5FGP-E	94407			.050
1999-98	V6 2.7L		LZTR5A-13	4306			LZTR5AIX-13	2314	LZTR5AGP	3381	LZTR5A-13	4306	.050
	V6 3.2L		ZFR5LP-13G	7781			ZFR5FIX-11E	96807	ZFR5FGP-E	94407			.050
1997-93	V6 3.3L		GR45	4268					GR45GP	3142	GR45	4268	.050
	V6 3.5L		FR5-1	7252							FR5-1	7252	.035
<b>Journey</b>													
2017-11	L4 2.4L		<b>ZFR5F-11</b>	<b>2262</b>	FR5AHX	95839	ZFR5FIX-11	2477	ZFR5FGP	7098	ZFR5F-11	2262	.044
	V6 3.6L		SILZKR7B11	9723	LKR7BHX	94705	LKR7DIX-11S	93175	LKR7BGP-S	97390			.044
2010-09	L4 2.4L	Eng Desg ED3, Non-PZEV Eng.	<b>ZFR5F-11</b>	<b>2262</b>	FR5AHX	95839	ZFR5FIX-11	2477	ZFR5FGP	7098	ZFR5F-11	2262	.044
		PZEV, Eng Desg EDG	<b>ZFR5AP</b>	<b>92041</b>	FR5AHX-E	92375	ZFR5FIX-E	95332	ZFR5FGP-8E	92459			.032
	V6 3.5L		<b>ZFR5LP-13G</b>	<b>7781</b>			ZFR5FIX-11E	96807	ZFR5FGP-E	94407			.052
<b>Lancer</b>													
1989-86	L4 2.2L		GR4	2635			GR4IX	97382	GR4GP	2763	GR4	2635	.035
	L4 2.5L		GR4	2635			GR4IX	97382	GR4GP	2763	GR4	2635	.035
1985	L4 2.2L		GR4	2635			GR4IX	97382	GR4GP	2763	GR4	2635	.035
<b>Magnum</b>													
2008-06	V6 2.7L		PLZTR5A-13	4998			LZTR5AIX-13	2314	LZTR5AGP	3381	LZTR5A-13	4306	.050
	V6 3.5L		<b>ZFR5LP-13G</b>	<b>7781</b>			ZFR5FIX-11E	96807	ZFR5FGP-E	94407			.052
	V8 5.7L	Dual Plug; 16 Req'd	LZTR4A-11	5306			LZTR4AIX-11	2313	LZTR4AGP	5017	LZTR4A-11	5306	.044
	V8 6.1L	Dual Plug; 16 Req'd	<b>PLZTR5A-13</b>	<b>4998</b>			LZTR5AIX-13	2314	LZTR5AGP	3381	LZTR5A-13	4306	.052
2005	V6 2.7L		<b>PLZTR5A-13</b>	<b>4998</b>			LZTR5AIX-13	2314	LZTR5AGP	3381	LZTR5A-13	4306	.052
	V6 3.5L		<b>ZFR5LP-13G</b>	<b>7781</b>			ZFR5FIX-11E	96807	ZFR5FGP-E	94407			.052
	V8 5.7L	Dual Plug; 16 Req'd	LZTR4A-11	5306			LZTR4AIX-11	2313	LZTR4AGP	5017	LZTR4A-11	5306	.044
<b>Mini Ram</b>													
1988-87	L4 2.2L		GR4	2635			GR4IX	97382	GR4GP	2763	GR4	2635	.035
	L4 2.5L		GR4	2635			GR4IX	97382	GR4GP	2763	GR4	2635	.035
	L4 2.6L		<b>BPR5ES-11</b>	<b>7634</b>			BPR5EIX-11	2115	BPR5EGP	7082	BPR5EY-11	6937	.040
	V6 3.0L		<b>BPR5ES-11</b>	<b>7634</b>			BPR5EIX-11	2115	BPR5EGP	7082	BPR5EY-11	6937	.044





Year	Cyl. L	Notes	Original Equipment		Ruthenium HX		Iridium IX		G-Power		V-Power		Gap
			Part	Stock	Part	Stock	Part	Stock	Part	Stock	Part	Stock	
<b>DODGE (Cont'd)</b>													
Mini Ram (Cont'd)													
1986-85	L4 2.2L		GR4	2635			GR4IX	97382	GR4GP	2763	GR4	2635	.035
	L4 2.6L		<b>BPR6ES-11</b>	<b>7133</b>			BPR6EIX-11	3903	BPR6EGP	7084	BPR6EY-11	6261	.040
Monaco													
1992-90	V6 3.0L		TR5	2238			TR5IX	7397	TR5GP	3186	TR5	2238	.044
Neon													
2005-03	L4 2.0L		BKR6E	6962	FR6BHX-S	95159	BKR6EIX	6418	BKR6EGP	7092	BKR6E	6962	.035
	L4 2.4L		LZTR5A-13	4306			LZTR5AIX-13	2314	LZTR5AGP	3381	LZTR5A-13	4306	.052
2002-97	L4 2.0L		BKR6E	6962	FR6BHX-S	95159	BKR6EIX	6418	BKR6EGP	7092	BKR6E	6962	.035
1996-95	L4 2.0L		BKR6E	6962			BKR6EIX	6418	BKR6EGP	7092	BKR6E	6962	.035
Nitro													
2011-09	V6 3.7L		<b>ZFR6F-11G</b>	<b>6987</b>	FR6BHX-S	95159	ZFR6FIX-11	6441	ZFR6FGP	7100	ZFR6F-11G	6987	.044
	V6 4.0L		<b>ZFR5LP-13G</b>	<b>7781</b>			ZFR5FIX-11E	96807	ZFR5FGP-E	94407			.052
2008-07	V6 3.7L		<b>ZFR6F-11G</b>	<b>6987</b>	FR6AHX-S	94279	ZFR6FIX-11	6441	ZFR6FGP	7100	ZFR6F-11G	6987	.044
	V6 4.0L		<b>ZFR5LP-13G</b>	<b>7781</b>			ZFR5FIX-11E	96807	ZFR5FGP-E	94407			.052
Omni													
1990-87	L4 2.2L		GR4	2635			GR4IX	97382	GR4GP	2763	GR4	2635	.035
1986-85	L4 1.6L		GR4	2635			GR4IX	97382	GR4GP	2763	GR4	2635	.035
	L4 2.2L		GR4	2635			GR4IX	97382	GR4GP	2763	GR4	2635	.035
Power Ram 50													
1986	L4 2.6L		<b>BPR6ES-11</b>	<b>7133</b>			BPR6EIX-11	3903	BPR6EGP	7084	BPR6EY-11	6261	.044
1985	L4 2.3L	DIESEL	Y-115R1	2161									
	L4 2.6L		<b>BPR6ES-11</b>	<b>7133</b>			BPR6EIX-11	3903	BPR6EGP	7084	BPR6EY-11	6261	.044
Raider													
1989	L4 2.6L		<b>BPR6ES-11</b>	<b>7133</b>			BPR6EIX-11	3903	BPR6EGP	7084	BPR6EY-11	6261	.044
	V6 3.0L		<b>BPR5ES-11</b>	<b>7634</b>			BPR5EIX-11	2115	BPR5EGP	7082	BPR5EY-11	6937	.044
1988-87	L4 2.6L		<b>BPR6ES-11</b>	<b>7133</b>			BPR6EIX-11	3903	BPR6EGP	7084	BPR6EY-11	6261	.044
Ram 50													
1993-92	L4 2.4L		<b>BPR6ES-11</b>	<b>7133</b>			BPR6EIX-11	3903	BPR6EGP	7084	BPR6EY-11	6261	.044
1991-90	L4 2.4L		<b>BPR6ES-11</b>	<b>7133</b>			BPR6EIX-11	3903	BPR6EGP	7084	BPR6EY-11	6261	.044
	V6 3.0L		<b>BPR5ES-11</b>	<b>7634</b>			BPR5EIX-11	2115	BPR5EGP	7082	BPR5EY-11	6937	.044
1989	L4 2.0L		<b>BPR6ES-11</b>	<b>7133</b>			BPR6EIX-11	3903	BPR6EGP	7084	BPR6EY-11	6261	.040
	L4 2.6L		<b>BPR6ES-11</b>	<b>7133</b>			BPR6EIX-11	3903	BPR6EGP	7084	BPR6EY-11	6261	.040
1988-86	L4 2.0L		<b>BPR6ES-11</b>	<b>7133</b>			BPR6EIX-11	3903	BPR6EGP	7084	BPR6EY-11	6261	.040
	L4 2.6L		<b>BPR6ES-11</b>	<b>7133</b>			BPR6EIX-11	3903	BPR6EGP	7084	BPR6EY-11	6261	.044
1985	L4 2.0L		<b>BPR6ES-11</b>	<b>7133</b>			BPR6EIX-11	3903	BPR6EGP	7084	BPR6EY-11	6261	.040
	L4 2.3L	DIESEL	Y-115R1	2161									
	L4 2.6L		<b>BPR6ES-11</b>	<b>7133</b>			BPR6EIX-11	3903	BPR6EGP	7084	BPR6EY-11	6261	.044
Ram 1500													
2010-09	V6 3.7L		<b>ZFR6F-11G</b>	<b>6987</b>	FR6BHX-S	95159	ZFR6FIX-11	6441	ZFR6FGP	7100	ZFR6F-11G	6987	.044
	V8 4.7L	Dual Plug; Exhaust Side (8 Req'd)	PLZFR5B13EG	97606			LZFR5AIX-11E	92460	LZFR5AGP-E	90192			.051
		Dual Plug; Intake Side (8 Req'd)	LZFR5C-11	92174			LFR5AIX-11	4469	LFR5AGP	5018			.039
	V8 5.7L	Dual Plug; 16 Req'd	<b>LZFR5C-11</b>	<b>92174</b>	LFR5AHX	96355	LFR5AIX-11	4469	LFR5AGP	5018			.044
2008	V6 3.7L		<b>ZFR6F-11G</b>	<b>6987</b>	FR6AHX-S	94279	ZFR6FIX-11	6441	ZFR6FGP	7100	ZFR6F-11G	6987	.044
	V8 4.7L	Dual Plug; Exhaust Side (8 Req'd)	PLZFR5B13EG	97606			LZFR5AIX-11E	92460	LZFR5AGP-E	90192			.051
		Dual Plug; Intake Side (8 Req'd)	LZFR5C-11	92174			LFR5AIX-11	4469	LFR5AGP	5018			.039
	V8 5.7L	Dual Plug; 16 Req'd	LZTR4A-11	5306			LZTR4AIX-11	2313	LZTR4AGP	5017	LZTR4A-11	5306	.044
2007	V6 3.7L		<b>ZFR6F-11G</b>	<b>6987</b>	FR6AHX-S	94279	ZFR6FIX-11	6441	ZFR6FGP	7100	ZFR6F-11G	6987	.044
	V8 4.7L		ZFR6F-11G	6987	FR6AHX-S	94279	ZFR6FIX-11	6441	ZFR6FGP	7100	ZFR6F-11G	6987	.044
	V8 5.7L	Dual Plug; 16 Req'd	LZTR4A-11	5306			LZTR4AIX-11	2313	LZTR4AGP	5017	LZTR4A-11	5306	.044
2006-04	V6 3.7L		<b>ZFR6F-11G</b>	<b>6987</b>	FR6AHX-S	94279	ZFR6FIX-11	6441	ZFR6FGP	7100	ZFR6F-11G	6987	.044
	V8 4.7L		ZFR6F-11G	6987	FR6AHX-S	94279	ZFR6FIX-11	6441	ZFR6FGP	7100	ZFR6F-11G	6987	.044
	V8 5.7L	Dual Plug; 16 Req'd	LZTR4A-11	5306			LZTR4AIX-11	2313	LZTR4AGP	5017	LZTR4A-11	5306	.044
	V10 8.3L		ZFR5N	3459							ZFR5N	3459	.035
2003	V6 3.7L		<b>ZFR6F-11G</b>	<b>6987</b>	FR6AHX-S	94279	ZFR6FIX-11	6441	ZFR6FGP	7100	ZFR6F-11G	6987	.044

**Bold denotes NGK OE Manufacturer and/or OE Service Part**  
NOT BOLD denotes OE Equivalent Part

**Le texte en gras désigne une pièce d'équipement originale du manufacturier NGK et/ou pièce d'équipement originale de service**  
Le texte non en gras désigne une pièce d'équipement originale équivalente

Note: Due to different operating or engine conditions, alternate heat range plugs may be required.

Note: En raison de différences au niveau du fonctionnement ou des conditions du moteur, d'autres types de bougies avec variation de chaleur peuvent être nécessaires





Year	Cyl. L	Notes	Original Equipment		Ruthenium HX		Iridium IX		G-Power		V-Power		Gap
			Part	Stock	Part	Stock	Part	Stock	Part	Stock	Part	Stock	
<b>DODGE (Cont'd)</b>													
<b>Ram 1500 (Cont'd)</b>													
2003	V8 4.7L		ZFR6F-11G	6987	FR6AHX-S	94279	ZFR6FIX-11	6441	ZFR6FGP	7100	ZFR6F-11G	6987	.044
	V8 5.7L	Dual Plug; 16 Req'd	LZTR4A-11	5306			LZTR4AIX-11	2313	LZTR4AGP	5017	LZTR4A-11	5306	.044
	V8 5.9L		ZFR6F-11	4291	FR6AHX-S	94279	ZFR6FIX-11	6441	ZFR6FGP	7100	ZFR6F-11	4291	.040
2002	V6 3.7L		<b>ZFR6F-11G</b>	<b>6987</b>	FR6AHX-S	94279	ZFR6FIX-11	6441	ZFR6FGP	7100	ZFR6F-11G	6987	.044
	V8 4.7L		ZFR6F-11G	6987	FR6AHX-S	94279	ZFR6FIX-11	6441	ZFR6FGP	7100	ZFR6F-11G	6987	.044
	V8 5.9L		ZFR6F-11	4291	FR6AHX-S	94279	ZFR6FIX-11	6441	ZFR6FGP	7100	ZFR6F-11	4291	.040
2001-98	V6 3.9L		ZFR6F-11	4291	FR6AHX-S	94279	ZFR6FIX-11	6441	ZFR6FGP	7100	ZFR6F-11	4291	.040
	V8 5.2L		ZFR6F-11	4291	FR6AHX-S	94279	ZFR6FIX-11	6441	ZFR6FGP	7100	ZFR6F-11	4291	.040
	V8 5.9L		ZFR6F-11	4291	FR6AHX-S	94279	ZFR6FIX-11	6441	ZFR6FGP	7100	ZFR6F-11	4291	.040
1997	V6 3.9L		ZFR6F-11	4291	FR6AHX-S	94279	ZFR6FIX-11	6441	ZFR6FGP	7100	ZFR6F-11	4291	.040
	V8 5.2L		ZFR6F-11	4291	FR6AHX-S	94279	ZFR6FIX-11	6441	ZFR6FGP	7100	ZFR6F-11	4291	.040
	V8 5.9L		BKR5E	7938			BKR5EIX	6341	BKR5EGP	7090	BKR5E	7938	.035
1996	V6 3.9L		BKR5E	7938			BKR5EIX	6341	BKR5EGP	7090	BKR5E	7938	.035
	V8 5.2L		BKR5E	7938			BKR5EIX	6341	BKR5EGP	7090	BKR5E	7938	.035
	V8 5.9L		BKR5E	7938			BKR5EIX	6341	BKR5EGP	7090	BKR5E	7938	.035
1995-94	V6 3.9L		FR4	5155			BKR4EIX	5693	FR4GP	2685	FR4	5155	.035
	V8 5.2L		FR4	5155			BKR4EIX	5693	FR4GP	2685	FR4	5155	.035
	V8 5.9L		FR4	5155			BKR4EIX	5693	FR4GP	2685	FR4	5155	.035
<b>Ram 1500 Van</b>													
2003-99	V6 3.9L		ZFR6F-11	4291	FR6AHX-S	94279	ZFR6FIX-11	6441	ZFR6FGP	7100	ZFR6F-11	4291	.040
	V8 5.2L		ZFR6F-11	4291	FR6AHX-S	94279	ZFR6FIX-11	6441	ZFR6FGP	7100	ZFR6F-11	4291	.040
	V8 5.9L		ZFR6F-11	4291	FR6AHX-S	94279	ZFR6FIX-11	6441	ZFR6FGP	7100	ZFR6F-11	4291	.040
<b>Ram 2500</b>													
2010-09	V8 5.7L	Dual Plug; 16 Req'd	<b>LZFR5C-11</b>	<b>92174</b>	LFR5AHX	96355	LFR5AIX-11	4469	LFR5AGP	5018			.044
2008-04	V8 5.7L	Dual Plug; 16 Req'd	LZTR4A-11	5306			LZTR4AIX-11	2313	LZTR4AGP	5017	LZTR4A-11	5306	.044
2003	V8 5.7L	Dual Plug; 16 Req'd	LZTR4A-11	5306			LZTR4AIX-11	2313	LZTR4AGP	5017	LZTR4A-11	5306	.044
	V10 8.0L		ZFR6F-11G	6987	FR6BHX-S	95159	ZFR6FIX-11	6441	ZFR6FGP	7100	ZFR6F-11G	6987	.045
2002-98	V8 5.9L		ZFR6F-11	4291	FR6AHX-S	94279	ZFR6FIX-11	6441	ZFR6FGP	7100	ZFR6F-11	4291	.040
	V10 8.0L		ZFR6F-11G	6987	FR6BHX-S	95159	ZFR6FIX-11	6441	ZFR6FGP	7100	ZFR6F-11G	6987	.045
1997	V8 5.9L		BKR5E	7938			BKR5EIX	6341	BKR5EGP	7090	BKR5E	7938	.035
	V10 8.0L		ZFR6F-11G	6987	FR6BHX-S	95159	ZFR6FIX-11	6441	ZFR6FGP	7100	ZFR6F-11G	6987	.045
1996	V8 5.2L		BKR5E	7938			BKR5EIX	6341	BKR5EGP	7090	BKR5E	7938	.035
	V8 5.9L		BKR5E	7938			BKR5EIX	6341	BKR5EGP	7090	BKR5E	7938	.035
	V10 8.0L		ZFR5F-11	2262			ZFR5FIX-11	2477	ZFR5FGP	7098	ZFR5F-11	2262	.045
1995	V8 5.2L		FR4	5155			BKR4EIX	5693	FR4GP	2685	FR4	5155	.035
	V8 5.9L	Vin 5	BKR5E	7938			BKR5EIX	6341	BKR5EGP	7090	BKR5E	7938	.035
		Vin Z	FR4	5155			BKR4EIX	5693	FR4GP	2685	FR4	5155	.035
	V10 8.0L		ZFR5F-11	2262			ZFR5FIX-11	2477	ZFR5FGP	7098	ZFR5F-11	2262	.045
1994	V8 5.2L		FR4	5155			BKR4EIX	5693	FR4GP	2685	FR4	5155	.035
	V8 5.9L		FR4	5155			BKR4EIX	5693	FR4GP	2685	FR4	5155	.035
	V10 8.0L		ZFR5F-11	2262			ZFR5FIX-11	2477	ZFR5FGP	7098	ZFR5F-11	2262	.045
<b>Ram 2500 Van</b>													
2003-02	V8 5.2L		ZFR6F-11	4291	FR6AHX-S	94279	ZFR6FIX-11	6441	ZFR6FGP	7100	ZFR6F-11	4291	.040
	V8 5.9L		ZFR6F-11	4291	FR6AHX-S	94279	ZFR6FIX-11	6441	ZFR6FGP	7100	ZFR6F-11	4291	.040
2001	V6 3.9L		ZFR6F-11	4291	FR6AHX-S	94279	ZFR6FIX-11	6441	ZFR6FGP	7100	ZFR6F-11	4291	.040
	V8 5.2L		ZFR6F-11	4291	FR6AHX-S	94279	ZFR6FIX-11	6441	ZFR6FGP	7100	ZFR6F-11	4291	.040
	V8 5.9L		ZFR6F-11	4291	FR6AHX-S	94279	ZFR6FIX-11	6441	ZFR6FGP	7100	ZFR6F-11	4291	.040
2000-99	V8 5.2L		ZFR6F-11	4291	FR6AHX-S	94279	ZFR6FIX-11	6441	ZFR6FGP	7100	ZFR6F-11	4291	.040
	V8 5.9L		ZFR6F-11	4291	FR6AHX-S	94279	ZFR6FIX-11	6441	ZFR6FGP	7100	ZFR6F-11	4291	.040
<b>Ram 3500</b>													
2009	V8 5.7L	Dual Plug; 16 Req'd	<b>LZFR5C-11</b>	<b>92174</b>	LFR5AHX	96355	LFR5AIX-11	4469	LFR5AGP	5018			.044
2008-04	V8 5.7L	Dual Plug; 16 Req'd	LZTR4A-11	5306			LZTR4AIX-11	2313	LZTR4AGP	5017	LZTR4A-11	5306	.044
2003	V8 5.7L	Dual Plug; 16 Req'd	LZTR4A-11	5306			LZTR4AIX-11	2313	LZTR4AGP	5017	LZTR4A-11	5306	.044
	V10 8.0L		ZFR6F-11G	6987	FR6BHX-S	95159	ZFR6FIX-11	6441	ZFR6FGP	7100	ZFR6F-11G	6987	.045
2002-98	V8 5.9L		ZFR6F-11	4291	FR6AHX-S	94279	ZFR6FIX-11	6441	ZFR6FGP	7100	ZFR6F-11	4291	.040
	V10 8.0L		ZFR6F-11G	6987	FR6BHX-S	95159	ZFR6FIX-11	6441	ZFR6FGP	7100	ZFR6F-11G	6987	.045
1997	V8 5.9L		BKR5E	7938			BKR5EIX	6341	BKR5EGP	7090	BKR5E	7938	.035



Year	Cyl. L	Notes	Original Equipment		Ruthenium HX		Iridium IX		G-Power		V-Power		Gap
			Part	Stock	Part	Stock	Part	Stock	Part	Stock	Part	Stock	
<b>DODGE (Cont'd)</b>													
<b>Ram 3500 (Cont'd)</b>													
1997	V10 8.0L		ZFR6F-11G	6987	FR6BHX-S	95159	ZFR6FIX-11	6441	ZFR6FGP	7100	ZFR6F-11G	6987	.045
1996	V8 5.9L		BKR5E	7938			BKR5EIX	6341	BKR5EGP	7090	BKR5E	7938	.035
	V10 8.0L		ZFR5F-11	2262			ZFR5FIX-11	2477	ZFR5FGP	7098	ZFR5F-11	2262	.045
1995	V8 5.9L		WR5	2438			WR5IX	7510			WR5	2438	.035
	V10 8.0L		ZFR5F-11	2262			ZFR5FIX-11	2477	ZFR5FGP	7098	ZFR5F-11	2262	.045
1994	V8 5.9L	Vin 5	WR5	2438			WR5IX	7510			WR5	2438	.035
	V10 8.0L		ZFR5F-11	2262			ZFR5FIX-11	2477	ZFR5FGP	7098	ZFR5F-11	2262	.045
<b>Ram 3500 Van</b>													
2003-99	V8 5.2L		ZFR6F-11	4291	FR6AHX-S	94279	ZFR6FIX-11	6441	ZFR6FGP	7100	ZFR6F-11	4291	.040
	V8 5.9L		ZFR6F-11	4291	FR6AHX-S	94279	ZFR6FIX-11	6441	ZFR6FGP	7100	ZFR6F-11	4291	.040
<b>Ramcharger</b>													
1993	V8 5.2L		FR4	5155			BKR4EIX	5693	FR4GP	2685	FR4	5155	.035
	V8 5.9L		FR4	5155			BKR4EIX	5693	FR4GP	2685	FR4	5155	.035
1992	V8 5.2L		FR4	5155			BKR4EIX	5693	FR4GP	2685	FR4	5155	.035
	V8 5.9L		GR4	2635			GR4IX	97382	GR4GP	2763	GR4	2635	.035
1991-85	V8 5.2L		GR4	2635			GR4IX	97382	GR4GP	2763	GR4	2635	.035
	V8 5.9L		GR4	2635			GR4IX	97382	GR4GP	2763	GR4	2635	.035
<b>Shadow</b>													
1994-92	L4 2.2L		GR4	2635			GR4IX	97382	GR4GP	2763	GR4	2635	.035
	L4 2.5L		GR4	2635			GR4IX	97382	GR4GP	2763	GR4	2635	.035
	V6 3.0L		<b>BPR5ES-11</b>	<b>7634</b>			BPR5EIX-11	2115	BPR5EGP	7082	BPR5EY-11	6937	.044
1991-88	L4 2.2L		GR4	2635			GR4IX	97382	GR4GP	2763	GR4	2635	.035
	L4 2.5L		GR4	2635			GR4IX	97382	GR4GP	2763	GR4	2635	.035
1987	L4 2.2L		GR4	2635			GR4IX	97382	GR4GP	2763	GR4	2635	.035
<b>Spirit</b>													
1995-93	L4 2.5L		GR4	2635			GR4IX	97382	GR4GP	2763	GR4	2635	.035
	V6 3.0L		<b>BPR5ES-11</b>	<b>7634</b>			BPR5EIX-11	2115	BPR5EGP	7082	BPR5EY-11	6937	.044
1992-91	L4 2.2L		GR4	2635			GR4IX	97382	GR4GP	2763	GR4	2635	.035
	L4 2.5L		GR4	2635			GR4IX	97382	GR4GP	2763	GR4	2635	.035
	V6 3.0L		<b>BPR5ES-11</b>	<b>7634</b>			BPR5EIX-11	2115	BPR5EGP	7082	BPR5EY-11	6937	.044
1990-89	L4 2.5L		GR4	2635			GR4IX	97382	GR4GP	2763	GR4	2635	.035
	V6 3.0L		<b>BPR5ES-11</b>	<b>7634</b>			BPR5EIX-11	2115	BPR5EGP	7082	BPR5EY-11	6937	.044
<b>Sprinter 2500</b>													
2008-07	V6 3.5L		<b>PLKR7A</b>	<b>4288</b>	LKR7BHX	94705	LKR7AIX	93911	LKR7BGP-8	95983			.032
2006-03	L5 2.7L	DIESEL	Y-745U	4705									
<b>Sprinter 3500</b>													
2008-07	V6 3.5L		<b>PLKR7A</b>	<b>4288</b>	LKR7BHX	94705	LKR7AIX	93911	LKR7BGP-8	95983			.032
2006-03	L5 2.7L	DIESEL	Y-745U	4705									
<b>Stealth</b>													
1996-91	V6 3.0L	DOHC	<b>PFR6J-11</b>	<b>2743</b>			BKR6EIX-11	3764	BKR6EGP	7092	BKR6E-11	2756	.044
		SOHC	BPR5ES-11	7634			BPR5EIX-11	2115	BPR5EGP	7082	BPR5EY-11	6937	.044
<b>Stratus</b>													
2006	L4 2.4L		LZTR5A-13	4306			LZTR5AIX-13	2314	LZTR5AGP	3381	LZTR5A-13	4306	.050
	V6 2.7L		LZTR5A-13	4306			LZTR5AIX-13	2314	LZTR5AGP	3381	LZTR5A-13	4306	.050
2005-04	L4 2.4L	Vin G	PFR6J-11	2743	FR6BHX-S	95159	BKR6EIX-11	3764	BKR6EGP	7092	BKR6E-11	2756	.044
		Vin J	<b>PLZTR4A-13</b>	<b>4997</b>			LZTR4AIX-11	2313	LZTR4AGP	5017	LZTR4A-11	5306	.052
		Vin X	LZTR5A-13	4306			LZTR5AIX-13	2314	LZTR5AGP	3381	LZTR5A-13	4306	.050
	V6 2.7L		LZTR5A-13	4306			LZTR5AIX-13	2314	LZTR5AGP	3381	LZTR5A-13	4306	.050
	V6 3.0L		<b>PFR6G-11</b>	<b>5555</b>	FR6AHX-S	94279	BKR6EIX-11	3764	BKR6EGP	7092	BKR6E-11	2756	.044
2003-01	L4 2.4L	Vin G	PFR6J-11	2743	FR6BHX-S	95159	BKR6EIX-11	3764	BKR6EGP	7092	BKR6E-11	2756	.044
		Vin X	LZTR5A-13	4306			LZTR5AIX-13	2314	LZTR5AGP	3381	LZTR5A-13	4306	.050
	V6 2.7L		LZTR5A-13	4306			LZTR5AIX-13	2314	LZTR5AGP	3381	LZTR5A-13	4306	.050
2000-97	V6 3.0L		<b>PFR6G-11</b>	<b>5555</b>	FR6AHX-S	94279	BKR6EIX-11	3764	BKR6EGP	7092	BKR6E-11	2756	.044
	L4 2.0L		BKR6E	6962	FR6BHX-S	95159	BKR6EIX	6418	BKR6EGP	7092	BKR6E	6962	.035
	L4 2.4L		FR45	3686					FR45GP	3072	FR45	3686	.050
1996-95	V6 2.5L		PFR5G-11	2647	FR5AHX	95839	BKR5EIX-11	5464	BKR5EGP	7090	BKR5E-11	6953	.044
	L4 2.0L		BKR6E	6962			BKR6EIX	6418	BKR6EGP	7092	BKR6E	6962	.035

**Bold denotes NGK OE Manufacturer and/or OE Service Part**  
NOT BOLD denotes OE Equivalent Part

**Le texte en gras désigne une pièce d'équipement originale du manufacturier NGK et/ou pièce d'équipement originale de service**  
Le texte non en gras désigne une pièce d'équipement originale équivalente

Note: Due to different operating or engine conditions, alternate heat range plugs may be required.

Note: En raison de différences au niveau du fonctionnement ou des conditions du moteur, d'autres types de bougies avec variation de chaleur peuvent être nécessaires



Year	Cyl. L	Notes	Original Equipment		Ruthenium HX		Iridium IX		G-Power		V-Power		Gap
			Part	Stock	Part	Stock	Part	Stock	Part	Stock	Part	Stock	
<b>DODGE (Cont'd)</b>													
<b>Stratus (Cont'd)</b>													
1996-95	L4 2.4L		FR45	3686					FR45GP	3072	FR45	3686	.050
	V6 2.5L		PFR5G-11	2647			BKR5EIX-11	5464	BKR5EGP	7090	BKR5E-11	6953	.044
<b>SX 2.0</b>													
2005-03	L4 2.0L		BKR6E	6962	FR6BHX-S	95159	BKR6EIX	6418	BKR6EGP	7092	BKR6E	6962	.035
<b>Viper</b>													
2017-15	V10 8.4L		PLZTR5A-13	4998			LZTR5AIX-13	2314	LZTR5AGP	3381	LZTR5A-13	4306	.050
2010-08	V10 8.4L		PLZTR5A-13	4998			LZTR5AIX-13	2314	LZTR5AGP	3381	LZTR5A-13	4306	.050
2006-03	V10 8.3L		ZFR5N	3459							ZFR5N	3459	.035
2002-92	V10 8.0L		FR5-1	7252							FR5-1	7252	.035
<b>W100</b>													
1989	V6 3.9L		GR4	2635			GR4IX	97382	GR4GP	2763	GR4	2635	.035
	V8 5.2L		GR4	2635			GR4IX	97382	GR4GP	2763	GR4	2635	.035
1988	V8 5.2L		GR4	2635			GR4IX	97382	GR4GP	2763	GR4	2635	.035
	V8 5.9L		GR4	2635			GR4IX	97382	GR4GP	2763	GR4	2635	.035
1987-85	L6 3.7L		UR4	6630			UR4IX	7401	UR4GP	2869	UR4	6630	.035
	V8 5.2L		GR4	2635			GR4IX	97382	GR4GP	2763	GR4	2635	.035
	V8 5.9L		GR4	2635			GR4IX	97382	GR4GP	2763	GR4	2635	.035
<b>W150</b>													
1993	V6 3.9L		FR4	5155			BKR4EIX	5693	FR4GP	2685	FR4	5155	.035
	V8 5.2L		FR4	5155			BKR4EIX	5693	FR4GP	2685	FR4	5155	.035
	V8 5.9L		FR4	5155			BKR4EIX	5693	FR4GP	2685	FR4	5155	.035
1992	V6 3.9L		FR4	5155			BKR4EIX	5693	FR4GP	2685	FR4	5155	.035
	V8 5.2L		FR4	5155			BKR4EIX	5693	FR4GP	2685	FR4	5155	.035
1991-89	V6 3.9L		GR4	2635			GR4IX	97382	GR4GP	2763	GR4	2635	.035
	V8 5.2L		GR4	2635			GR4IX	97382	GR4GP	2763	GR4	2635	.035
	V8 5.9L		GR4	2635			GR4IX	97382	GR4GP	2763	GR4	2635	.035
1988	V8 5.2L		GR4	2635			GR4IX	97382	GR4GP	2763	GR4	2635	.035
	V8 5.9L		GR4	2635			GR4IX	97382	GR4GP	2763	GR4	2635	.035
1987-85	L6 3.7L		UR4	6630			UR4IX	7401	UR4GP	2869	UR4	6630	.035
	V8 5.2L		GR4	2635			GR4IX	97382	GR4GP	2763	GR4	2635	.035
	V8 5.9L		GR4	2635			GR4IX	97382	GR4GP	2763	GR4	2635	.035
<b>W250</b>													
1993	V8 5.2L		FR4	5155			BKR4EIX	5693	FR4GP	2685	FR4	5155	.035
	V8 5.9L	Vin 5	AR6FS	3323									.035
		Vin Z	FR4	5155			BKR4EIX	5693	FR4GP	2685	FR4	5155	.035
1992	V8 5.2L		FR4	5155			BKR4EIX	5693	FR4GP	2685	FR4	5155	.035
	V8 5.9L		GR4	2635			GR4IX	97382	GR4GP	2763	GR4	2635	.035
1991-89	V8 5.2L		GR4	2635			GR4IX	97382	GR4GP	2763	GR4	2635	.035
	V8 5.9L	Vin 5	AR6FS	3323									.035
		Vin Z	GR4	2635			GR4IX	97382	GR4GP	2763	GR4	2635	.035
1988-87	V8 5.2L		GR4	2635			GR4IX	97382	GR4GP	2763	GR4	2635	.035
	V8 5.9L	Vin 1	GR4	2635			GR4IX	97382	GR4GP	2763	GR4	2635	.035
		Vin 5	AR6FS	3323									.035
		Vin W	GR4	2635			GR4IX	97382	GR4GP	2763	GR4	2635	.035
1986-85	V8 5.2L		GR4	2635			GR4IX	97382	GR4GP	2763	GR4	2635	.035
	V8 5.9L		GR4	2635			GR4IX	97382	GR4GP	2763	GR4	2635	.035
<b>W350</b>													
1993	V8 5.9L	Vin 5	AR6FS	3323									.035
		Vin Z	FR4	5155			BKR4EIX	5693	FR4GP	2685	FR4	5155	.035
1992-89	V8 5.9L	Vin 5	AR6FS	3323									.035
		Vin Z	GR4	2635			GR4IX	97382	GR4GP	2763	GR4	2635	.035
1988	V8 5.9L	Vin 1	GR4	2635			GR4IX	97382	GR4GP	2763	GR4	2635	.035
		Vin 5	AR6FS	3323									.035
1987	V8 5.9L	Vin 1	GR4	2635			GR4IX	97382	GR4GP	2763	GR4	2635	.035
		Vin 5	AR6FS	3323									.035
		Vin W	GR4	2635			GR4IX	97382	GR4GP	2763	GR4	2635	.035
1986-85	V8 5.9L		GR4	2635			GR4IX	97382	GR4GP	2763	GR4	2635	.035



Year	Cyl. L	Notes	Original Equipment		Ruthenium HX		Iridium IX		G-Power		V-Power		Gap
			Part	Stock	Part	Stock	Part	Stock	Part	Stock	Part	Stock	
<b>EAGLE</b>													
2000 GTX													
1993-91	L4 2.0L		<b>BPR6ES-11</b>	<b>7133</b>			BPR6EIX-11	3903	BPR6EGP	7084	BPR6EY-11	6261	.044
Medallion													
1989-88	L4 2.2L		TR5	2238			TR5IX	7397	TR5GP	3186	TR5	2238	.040
Premier													
1992-90	V6 3.0L		TR5	2238			TR5IX	7397	TR5GP	3186	TR5	2238	.035
1989-88	L4 2.5L		FR5-1	7252							FR5-1	7252	.035
	V6 3.0L		TR5	2238			TR5IX	7397	TR5GP	3186	TR5	2238	.035
Summit													
1996-93	L4 1.5L		<b>BPR5ES-11</b>	<b>7634</b>			BPR5EIX-11	2115	BPR5EGP	7082	BPR5EY-11	6937	.044
	L4 1.8L		<b>BKR5E-11</b>	<b>6953</b>			BKR5EIX-11	5464	BKR5EGP	7090	BKR5E-11	6953	.044
	L4 2.4L		BKR5E-11	6953			BKR5EIX-11	5464	BKR5EGP	7090	BKR5E-11	6953	.044
1992	L4 1.5L		<b>BPR5ES-11</b>	<b>7634</b>			BPR5EIX-11	2115	BPR5EGP	7082	BPR5EY-11	6937	.044
	L4 1.8L		<b>BKR5E-11</b>	<b>6953</b>			BKR5EIX-11	5464	BKR5EGP	7090	BKR5E-11	6953	.044
	L4 2.4L		<b>BPR5ES-11</b>	<b>7634</b>			BPR5EIX-11	2115	BPR5EGP	7082	BPR5EY-11	6937	.044
1991	L4 1.5L		<b>BPR5ES-11</b>	<b>7634</b>			BPR5EIX-11	2115	BPR5EGP	7082	BPR5EY-11	6937	.044
1990-89	L4 1.5L		<b>BPR5ES-11</b>	<b>7634</b>			BPR5EIX-11	2115	BPR5EGP	7082	BPR5EY-11	6937	.044
	L4 1.6L		<b>BPR6ES-11</b>	<b>7133</b>			BPR6EIX-11	3903	BPR6EGP	7084	BPR6EY-11	6261	.044
Talon													
1998-97	L4 2.0L	Naturally Aspirated	BKR6E-11	2756	FR6BHX-S	95159	BKR6EIX-11	3764	BKR6EGP	7092	BKR6E-11	2756	.050
		Turbo	<b>BPR6EKN</b>	<b>6757</b>			BPR6EIX	6637	BPR6EGP	7084			.032
1996-95	L4 2.0L	Naturally Aspirated	BKR6E-11	2756			BKR6EIX-11	3764	BKR6EGP	7092	BKR6E-11	2756	.050
		Turbo	<b>BPR6EKN</b>	<b>6757</b>			BPR6EIX	6637	BPR6EGP	7084			.032
1994-93	L4 1.8L		<b>BPR6ES-11</b>	<b>7133</b>			BPR6EIX-11	3903	BPR6EGP	7084	BPR6EY-11	6261	.044
	L4 2.0L	Naturally Aspirated	<b>BPR6ES-11</b>	<b>7133</b>			BPR6EIX-11	3903	BPR6EGP	7084	BPR6EY-11	6261	.044
		Turbo	<b>BPR6ES</b>	<b>7131</b>			BPR6EIX	6637	BPR6EGP	7084	BPR6EY	6427	.032
1992-90	L4 2.0L	Naturally Aspirated	<b>BPR6ES-11</b>	<b>7133</b>			BPR6EIX-11	3903	BPR6EGP	7084	BPR6EY-11	6261	.044
		Turbo	<b>BPR6ES</b>	<b>7131</b>			BPR6EIX	6637	BPR6EGP	7084	BPR6EY	6427	.032
Vision													
1997-93	V6 3.3L		GR45	4268					GR45GP	3142	GR45	4268	.060
	V6 3.5L		FR5-1	7252							FR5-1	7252	.035
Vista													
1992	L4 1.5L		<b>BPR5ES-11</b>	<b>7634</b>			BPR5EIX-11	2115	BPR5EGP	7082	BPR5EY-11	6937	.044
1991-89	L4 1.5L		<b>BPR5ES-11</b>	<b>7634</b>			BPR5EIX-11	2115	BPR5EGP	7082	BPR5EY-11	6937	.044
	L4 2.0L		<b>BPR5ES-11</b>	<b>7634</b>			BPR5EIX-11	2115	BPR5EGP	7082	BPR5EY-11	6937	.040
1988	L4 1.5L		<b>BPR5ES-11</b>	<b>7634</b>			BPR5EIX-11	2115	BPR5EGP	7082	BPR5EY-11	6937	.044
<b>EXCALIBUR</b>													
Phaeton													
1989-86	V8 5.0L		UR45	6945			UR45IX	7559	UR45GP	3207	UR45	6945	.060
	V8 5.7L		UR45	6945			UR45IX	7559	UR45GP	3207	UR45	6945	.060
1985	V8 5.0L		UR45	6945			UR45IX	7559	UR45GP	3207	UR45	6945	.060
<b>FERRARI</b>													
328 GTB													
1989-85	V8 3.2L		DR8EA	7162			DR8EIX	6681					.025
328 GTS													
1989-85	V8 3.2L		DR8EA	7162			DR8EIX	6681					.025
348 GTB													
1994-93	V8 3.4L		DR8EA	7162			DR8EIX	6681					.025
348 GTS													
1994-93	V8 3.4L		DR8EA	7162			DR8EIX	6681					.025
348 Spider													
1995-93	V8 3.4L		DR8EA	7162			DR8EIX	6681					.025
348 TB													
1992-90	V8 3.4L		DR8EA	7162			DR8EIX	6681					.025
348 TS													
1992-89	V8 3.4L		DR8EA	7162			DR8EIX	6681					.025
360													
2005	V8 3.6L		<b>PMR8B</b>	<b>6378</b>									.028

**Bold denotes NGK OE Manufacturer and/or OE Service Part**  
NOT BOLD denotes OE Equivalent Part

**Le texte en gras désigne une pièce d'équipement originale du manufacturier NGK et/ou pièce d'équipement originale de service**  
Le texte non en gras désigne une pièce d'équipement originale équivalente

Note: Due to different operating or engine conditions, alternate heat range plugs may be required.

Note: En raison de différences au niveau du fonctionnement ou des conditions du moteur, d'autres types de bougies avec variation de chaleur peuvent être nécessaires



Year	Cyl. L	Notes	Original Equipment		Ruthenium HX		Iridium IX		G-Power		V-Power		Gap
			Part	Stock	Part	Stock	Part	Stock	Part	Stock	Part	Stock	
<b>FERRARI (Cont'd)</b>													
<b>360 (Cont'd)</b>													
2004-00	V8 3.6L		<b>PMR8A</b>	<b>5851</b>									.028
<b>456 GT</b>													
1998-95	V12 5.5L		DCPR9E	2641			DCPR9EIX	2316					.028
<b>456 GTA</b>													
1998-97	V12 5.5L		DCPR9E	2641			DCPR9EIX	2316					.028
<b>456 M</b>													
2001-99	V12 5.5L		DCPR9E	2641			DCPR9EIX	2316					.028
<b>456 M GT</b>													
2004-02	V12 5.5L		DCPR9E	2641			DCPR9EIX	2316					.028
<b>456 M GTA</b>													
2004-02	V12 5.5L		DCPR9E	2641			DCPR9EIX	2316					.028
<b>512 BB</b>													
1985	H12 4.9L		BR8EIX	5044			BR8EIX	5044					.020
<b>512 M</b>													
1995	H12 4.9L		DCPR9E	2641			DCPR9EIX	2316					.028
<b>512 TR</b>													
1994-92	H12 4.9L		DCPR9E	2641			DCPR9EIX	2316					.028
<b>550 Maranello</b>													
2002-97	V12 5.5L		DCPR9E	2641			DCPR9EIX	2316					.028
<b>575 M Maranello</b>													
2005-02	V12 5.7L		DCPR9E	2641			DCPR9EIX	2316					.028
<b>599 GTB</b>													
2010-07	V12 6.0L		<b>PMR8B</b>	<b>6378</b>									.028
<b>599 GTO</b>													
2011	V12 6.0L		<b>PMR8B</b>	<b>6378</b>									.028
<b>612 Scaglietti</b>													
2010-05	V12 5.7L		<b>DCPR9EIX</b>	<b>2316</b>			DCPR9EIX	2316					.028
<b>California</b>													
2013-09	V8 4.3L		<b>SPMR8A6HDG</b>	<b>92264</b>									.024
<b>Enzo</b>													
2004-03	V12 6.0L		<b>PMR8B</b>	<b>6378</b>									.032
<b>F40</b>													
1992-90	V8 2.9L		CR8EIB-9	5258									.036
<b>F50</b>													
1997-96	V12 4.7L		<b>PMR7A</b>	<b>4259</b>									.020
1995	V12 4.7L		<b>PMR7A</b>	<b>4259</b>									.035
<b>F355</b>													
1999	V8 3.5L		<b>PMR7A</b>	<b>4259</b>									.028
<b>F355 Berlinetta</b>													
1996-94	V8 3.5L		CR8E	1275			CR8EIX	4218					.025
<b>F355 F1</b>													
1998	V8 3.5L		<b>PMR7A</b>	<b>4259</b>									.028
<b>F355 GTS</b>													
1998-94	V8 3.5L		<b>PMR7A</b>	<b>4259</b>									.028
<b>F355 Spider</b>													
1999	V8 3.5L		<b>PMR7A</b>	<b>4259</b>									.028
1998-96	V8 3.5L		<b>PMR7A</b>	<b>4259</b>									.035
<b>F430</b>													
2009-06	V8 4.3L		<b>PMR8B</b>	<b>6378</b>									.028
<b>GTO</b>													
1987-85	V8 2.9L		BPR7ES	5534			BPR7EIX	4055					.025
<b>Mondial 3.2</b>													
1988-86	V8 3.2L		DR8EA	7162			DR8EIX	6681					.025
<b>Mondial 8</b>													
1985	V8 3.0L		DR8EA	7162			DR8EIX	6681					.025

130 **Bold denotes NGK OE Manufacturer and/or OE Service Part**  
NOT BOLD denotes OE Equivalent Part

El texto marcado en negrita indica que NGK es el proveedor para  
Equipo Original y/o Repuesto de Equipo Original.  
El texto sin negritas marca que es un equivalente al Equipo Original.

Note: Due to different operating or engine conditions, alternate heat range plugs may be required.

Nota: Debido a las diferentes condiciones de operación del motor, se puede requerir un rango térmico alterno.





Year	Cyl. L	Notes	Original Equipment		Ruthenium HX		Iridium IX		G-Power		V-Power		Gap
			Part	Stock	Part	Stock	Part	Stock	Part	Stock	Part	Stock	
<b>FERRARI (Cont'd)</b>													
Mondial t													
1993-89	V8 3.4L		DR8EA	7162			DR8EIX	6681					.025
Superamerica													
2005	V12 5.7L		<b>DCPR9EIX</b>	<b>2316</b>			DCPR9EIX	2316					.028
Testarossa													
1991-85	H12 4.9L		DR8EB	4855			DR8EIX	6681					.025
<b>FIAT</b>													
124 Spider													
2017	L4 1.4L		<b>SIKR9A7</b>	<b>93618</b>									.028
500													
2017-14	L4 1.4L	Naturally Aspirated	<b>IKR7H8</b>	<b>91715</b>			DCPR7EIX	6046	DCPR7EGP	1682			.036
		Turbo	<b>SIKR9A7</b>	<b>93618</b>									.028
2013-12	L4 1.4L	Naturally Aspirated	<b>DCPR7E-N-10</b>	<b>4983</b>			DCPR7EIX	6046	DCPR7EGP	1682			.040
		Turbo	<b>SIKR9A7</b>	<b>93618</b>									.028
500L													
2017-14	L4 1.4L	Turbo	<b>SIKR9A7</b>	<b>93618</b>									.028
500X													
2017-16	L4 1.4L	Turbo	<b>SIKR9A7</b>	<b>93618</b>									.028
	L4 2.4L		LZFR5CI-11	92145	LF5AHX	96355	LF5AIX-11	4469	LF5AGP	5018			.047
<b>FORD</b>													
Aerostar													
1997-96	V6 3.0L		PTR5F-11	6579			TR5IX	7397	TR5GP	3186	TR5	2238	.044
	V6 4.0L		PTR5C-13	7740			TR55IX	7164	TR55GP	3403	TR55	3951	.054
1995-90	V6 3.0L		TR5	2238			TR5IX	7397	TR5GP	3186	TR5	2238	.044
	V6 4.0L		PTR5C-13	7740			TR55IX	7164	TR55GP	3403	TR55	3951	.054
1989-88	V6 3.0L		TR5	2238			TR5IX	7397	TR5GP	3186	TR5	2238	.044
1987	L4 2.3L		TR5-1	7060			TR5-1IX	7243	TR5-1GP	3716	TR5-1	7060	.044
	V6 3.0L		TR5	2238			TR5IX	7397	TR5GP	3186	TR5	2238	.044
1986	L4 2.3L		TR5-1	7060			TR5-1IX	7243	TR5-1GP	3716	TR5-1	7060	.044
	V6 2.8L		TR5	2238			TR5IX	7397	TR5GP	3186	TR5	2238	.044
	V6 3.0L		TR5	2238			TR5IX	7397	TR5GP	3186	TR5	2238	.044
Aspire													
1997	L4 1.3L		BPR6EY-11	6261			BPR6EIX-11	3903	BPR6EGP	7084	BPR6EY-11	6261	.044
1996-94	L4 1.3L		BPR6ES-11	7133			BPR6EIX-11	3903	BPR6EGP	7084	BPR6EY-11	6261	.044
B600													
1989-88	V8 6.1L		UR5	2771			UR5IX	7177	UR5GP	3547	UR5	2771	.044
	V8 7.0L		UR5	2771			UR5IX	7177	UR5GP	3547	UR5	2771	.044
1987-86	V8 6.1L		UR5	2771			UR5IX	7177	UR5GP	3547	UR5	2771	.044
B700													
1989-86	V8 6.1L		UR5	2771			UR5IX	7177	UR5GP	3547	UR5	2771	.044
	V8 7.0L		UR5	2771			UR5IX	7177	UR5GP	3547	UR5	2771	.044
Bronco													
1996-93	V8 5.0L		UR45	6945			UR45IX	7559	UR45GP	3207	UR45	6945	.054
	V8 5.8L		UR5	2771			UR5IX	7177	UR5GP	3547	UR5	2771	.044
1992-89	L6 4.9L		WR4-1	4652							WR4-1	4652	.044
	V8 5.0L		UR45	6945			UR45IX	7559	UR45GP	3207	UR45	6945	.054
	V8 5.8L		UR5	2771			UR5IX	7177	UR5GP	3547	UR5	2771	.044
1988-87	L6 4.9L		WR4-1	4652							WR4-1	4652	.044
	V8 5.0L		UR4	6630			UR4IX	7401	UR4GP	2869	UR4	6630	.044
	V8 5.8L		UR5	2771			UR5IX	7177	UR5GP	3547	UR5	2771	.044
1986	L6 4.9L		WR5	2438			WR5IX	7510			WR5	2438	.044
	V8 5.0L		UR4	6630			UR4IX	7401	UR4GP	2869	UR4	6630	.044
	V8 5.8L		UR5	2771			UR5IX	7177	UR5GP	3547	UR5	2771	.044
1985	L6 4.9L		WR5	2438			WR5IX	7510			WR5	2438	.044
	V8 5.0L		UR4	6630			UR4IX	7401	UR4GP	2869	UR4	6630	.044
	V8 5.8L	Vin G	UR4	6630			UR4IX	7401	UR4GP	2869	UR4	6630	.044
		Vin H	UR5	2771			UR5IX	7177	UR5GP	3547	UR5	2771	.044

**Bold denotes NGK OE Manufacturer and/or OE Service Part**  
 NOT BOLD denotes OE Equivalent Part

Note: Due to different operating or engine conditions, alternate heat range plugs may be required.

**Le texte en gras désigne une pièce d'équipement originale du manufacturier NGK et/ou pièce d'équipement originale de service**  
 Le texte non en gras désigne une pièce d'équipement originale équivalente

Note: En raison de différences au niveau du fonctionnement ou des conditions du moteur, d'autres types de bougies avec variation de chaleur peuvent être nécessaires



Year	Cyl. L	Notes	Original Equipment		Ruthenium HX		Iridium IX		G-Power		V-Power		Gap
			Part	Stock	Part	Stock	Part	Stock	Part	Stock	Part	Stock	
<b>FORD (Cont'd)</b>													
<b>Bronco II</b>													
1990-86	V6 2.9L		TR5	2238			TR5IX	7397	TR5GP	3186	TR5	2238	.044
1985	V6 2.8L		TR5	2238			TR5IX	7397	TR5GP	3186	TR5	2238	.044
<b>C600</b>													
1986	V8 6.1L		UR5	2771			UR5IX	7177	UR5GP	3547	UR5	2771	.044
<b>C700</b>													
1986	V8 6.1L		UR5	2771			UR5IX	7177	UR5GP	3547	UR5	2771	.044
	V8 7.0L		UR5	2771			UR5IX	7177	UR5GP	3547	UR5	2771	.044
<b>C800</b>													
1986	V8 6.1L		UR5	2771			UR5IX	7177	UR5GP	3547	UR5	2771	.044
	V8 7.0L		UR5	2771			UR5IX	7177	UR5GP	3547	UR5	2771	.044
<b>C-Max</b>													
2017-13	L4 2.0L		<b>ILTR5K13</b>	<b>90607</b>	LTR5AHX	90220	LTR5IX-11	4344	LTR5GP	5019			.052
<b>Contour</b>													
2000-95	L4 2.0L		PTR5A-13	2467			LTR5IX-11	4344	LTR5GP	5019			.050
	V6 2.5L		PTR5C-13	7740			TR55IX	7164	TR55GP	3403	TR55	3951	.054
<b>Country Squire</b>													
1991-87	V8 5.0L		TR55-1	2683			TR55-1IX	7316	TR55-1GP	7159	TR55-1	2683	.050
<b>Crown Victoria</b>													
2011-09	V8 4.6L	FLEX, FFV and/or CNG Fuel Conversions	PTR6D-13	5598	TR6AHX	92714	TR6IX	3689	TR6GP	5141	TR6	4177	.044
		GAS	TR55	3951	TR5AHX	94567	TR55IX	7164	TR55GP	3403	TR55	3951	.054
2008-06	V8 4.6L	FLEX, FFV and/or CNG Fuel Conversions	PTR6D-13	5598	TR6AHX	92714	TR6IX	3689	TR6GP	5141	TR6	4177	.044
		GAS	PTR5C-13	7740	TR5AHX	94567	TR55IX	7164	TR55GP	3403	TR55	3951	.054
2005-98	V8 4.6L	CNG	PTR6D-13	5598	TR6AHX	92714	TR6IX	3689	TR6GP	5141	TR6	4177	.044
		GAS	PTR5C-13	7740	TR5AHX	94567	TR55IX	7164	TR55GP	3403	TR55	3951	.054
1997-96	V8 4.6L	CNG	PTR6D-13	5598			TR6IX	3689	TR6GP	5141	TR6	4177	.044
		GAS	PTR5C-13	7740			TR55IX	7164	TR55GP	3403	TR55	3951	.054
1995	V8 4.6L		PTR5C-13	7740			TR55IX	7164	TR55GP	3403	TR55	3951	.054
1994-92	V8 4.6L		TR55	3951			TR55IX	7164	TR55GP	3403	TR55	3951	.054
<b>E-150</b>													
2014-09	V8 4.6L		PTR5C-13	7740	TR5AHX	94567	TR55IX	7164	TR55GP	3403	TR55	3951	.054
	V8 5.4L		PTR5C-13	7740	TR5AHX	94567	TR55IX	7164	TR55GP	3403	TR55	3951	.054
2008-04	V8 4.6L		PTR5C-13	7740	TR5AHX	94567	TR55IX	7164	TR55GP	3403	TR55	3951	.054
	V8 5.4L	GAS	PTR5C-13	7740	TR5AHX	94567	TR55IX	7164	TR55GP	3403	TR55	3951	.054
2003	V6 4.2L		TR55-1GP	7159			TR55-1IX	7316	TR55-1GP	7159	TR55-1	2683	.054
	V8 4.6L		PTR5C-13	7740	TR5AHX	94567	TR55IX	7164	TR55GP	3403	TR55	3951	.054
	V8 5.4L	GAS	PTR5C-13	7740	TR5AHX	94567	TR55IX	7164	TR55GP	3403	TR55	3951	.054
<b>E-150 Club Wagon</b>													
2005-04	V8 4.6L		PTR5C-13	7740	TR5AHX	94567	TR55IX	7164	TR55GP	3403	TR55	3951	.054
	V8 5.4L	GAS	PTR5C-13	7740	TR5AHX	94567	TR55IX	7164	TR55GP	3403	TR55	3951	.054
2003	V6 4.2L		TR55-1GP	7159			TR55-1IX	7316	TR55-1GP	7159	TR55-1	2683	.054
	V8 4.6L		PTR5C-13	7740	TR5AHX	94567	TR55IX	7164	TR55GP	3403	TR55	3951	.054
	V8 5.4L	GAS	PTR5C-13	7740	TR5AHX	94567	TR55IX	7164	TR55GP	3403	TR55	3951	.054
<b>E-150 Econoline</b>													
2002-00	V6 4.2L		TR55-1GP	7159			TR55-1IX	7316	TR55-1GP	7159	TR55-1	2683	.054
	V8 4.6L		PTR5C-13	7740	TR5AHX	94567	TR55IX	7164	TR55GP	3403	TR55	3951	.054
	V8 5.4L	GAS	PTR5C-13	7740	TR5AHX	94567	TR55IX	7164	TR55GP	3403	TR55	3951	.054
1999	V6 4.2L		TR55-1GP	7159			TR55-1IX	7316	TR55-1GP	7159	TR55-1	2683	.054
	V8 4.6L		PTR5C-13	7740			TR55IX	7164	TR55GP	3403	TR55	3951	.054
	V8 5.4L	GAS	PTR5C-13	7740	TR5AHX	94567	TR55IX	7164	TR55GP	3403	TR55	3951	.054
1998	V6 4.2L		TR55-1GP	7159			TR55-1IX	7316	TR55-1GP	7159	TR55-1	2683	.054
	V8 4.6L		PTR5C-13	7740			TR55IX	7164	TR55GP	3403	TR55	3951	.054
	V8 5.4L	BI-FUEL	PTR5C-13	7740	TR5AHX	94567	TR55IX	7164	TR55GP	3403	TR55	3951	.054
		GAS	PTR5C-13	7740	TR5AHX	94567	TR55IX	7164	TR55GP	3403	TR55	3951	.054
1997	V6 4.2L		PTR5C-13	7740			TR55IX	7164	TR55GP	3403	TR55	3951	.054



Year	Cyl. L	Notes	Original Equipment		Ruthenium HX		Iridium IX		G-Power		V-Power		Gap
			Part	Stock	Part	Stock	Part	Stock	Part	Stock	Part	Stock	
<b>FORD (Cont'd)</b>													
<b>E-150 Econoline (Cont'd)</b>													
1997	V8 4.6L		PTR5C-13	7740			TR55IX	7164	TR55GP	3403	TR55	3951	.054
	V8 5.4L	GAS	PTR5C-13	7740	TR5AHX	94567	TR55IX	7164	TR55GP	3403	TR55	3951	.054
1996-89	L6 4.9L		WR4-1	4652							WR4-1	4652	.044
	V8 5.0L		UR45	6945			UR45IX	7559	UR45GP	3207	UR45	6945	.054
	V8 5.8L		UR5	2771			UR5IX	7177	UR5GP	3547	UR5	2771	.044
1988-87	L6 4.9L		WR4-1	4652							WR4-1	4652	.044
	V8 5.0L		UR4	6630			UR4IX	7401	UR4GP	2869	UR4	6630	.044
	V8 5.8L		UR5	2771			UR5IX	7177	UR5GP	3547	UR5	2771	.044
1986	L6 4.9L		WR5	2438			WR5IX	7510			WR5	2438	.044
	V8 5.0L		UR4	6630			UR4IX	7401	UR4GP	2869	UR4	6630	.044
	V8 5.8L		UR5	2771			UR5IX	7177	UR5GP	3547	UR5	2771	.044
1985	L6 4.9L	GAS	WR5	2438			WR5IX	7510			WR5	2438	.044
		LPG	WR5	2438			WR5IX	7510			WR5	2438	.034
	V8 5.0L		UR5	2771			UR5IX	7177	UR5GP	3547	UR5	2771	.044
	V8 5.8L	Vin G	UR4	6630			UR4IX	7401	UR4GP	2869	UR4	6630	.044
		Vin H	UR5	2771			UR5IX	7177	UR5GP	3547	UR5	2771	.044
<b>E-150 Econoline Club Wagon</b>													
2002-00	V6 4.2L		TR55-1GP	7159			TR55-1IX	7316	TR55-1GP	7159	TR55-1	2683	.054
	V8 4.6L		PTR5C-13	7740	TR5AHX	94567	TR55IX	7164	TR55GP	3403	TR55	3951	.054
	V8 5.4L	GAS	PTR5C-13	7740	TR5AHX	94567	TR55IX	7164	TR55GP	3403	TR55	3951	.054
1999	V6 4.2L		TR55-1GP	7159			TR55-1IX	7316	TR55-1GP	7159	TR55-1	2683	.054
	V8 4.6L		PTR5C-13	7740			TR55IX	7164	TR55GP	3403	TR55	3951	.054
	V8 5.4L	GAS	PTR5C-13	7740	TR5AHX	94567	TR55IX	7164	TR55GP	3403	TR55	3951	.054
1998	V6 4.2L		TR55-1GP	7159			TR55-1IX	7316	TR55-1GP	7159	TR55-1	2683	.054
	V8 4.6L		PTR5C-13	7740			TR55IX	7164	TR55GP	3403	TR55	3951	.054
	V8 5.4L	BI-FUEL	PTR5C-13	7740	TR5AHX	94567	TR55IX	7164	TR55GP	3403	TR55	3951	.054
		GAS	PTR5C-13	7740	TR5AHX	94567	TR55IX	7164	TR55GP	3403	TR55	3951	.054
1997	V6 4.2L		PTR5C-13	7740			TR55IX	7164	TR55GP	3403	TR55	3951	.054
	V8 4.6L		PTR5C-13	7740			TR55IX	7164	TR55GP	3403	TR55	3951	.054
	V8 5.4L	GAS	PTR5C-13	7740	TR5AHX	94567	TR55IX	7164	TR55GP	3403	TR55	3951	.054
1996-87	L6 4.9L		WR4-1	4652							WR4-1	4652	.044
	V8 5.0L		UR45	6945			UR45IX	7559	UR45GP	3207	UR45	6945	.054
	V8 5.8L		UR5	2771			UR5IX	7177	UR5GP	3547	UR5	2771	.044
1986	L6 4.9L		WR5	2438			WR5IX	7510			WR5	2438	.044
	V8 5.0L		UR45	6945			UR45IX	7559	UR45GP	3207	UR45	6945	.054
	V8 5.8L		UR5	2771			UR5IX	7177	UR5GP	3547	UR5	2771	.044
1985	L6 4.9L		WR5	2438			WR5IX	7510			WR5	2438	.044
	V8 5.0L		UR5	2771			UR5IX	7177	UR5GP	3547	UR5	2771	.044
	V8 5.8L	Vin G	UR4	6630			UR4IX	7401	UR4GP	2869	UR4	6630	.044
		Vin H	UR5	2771			UR5IX	7177	UR5GP	3547	UR5	2771	.044
<b>E-250</b>													
2014-09	V8 4.6L		PTR5C-13	7740	TR5AHX	94567	TR55IX	7164	TR55GP	3403	TR55	3951	.054
	V8 5.4L		PTR5C-13	7740	TR5AHX	94567	TR55IX	7164	TR55GP	3403	TR55	3951	.054
2008-06	V8 4.6L		PTR5C-13	7740	TR5AHX	94567	TR55IX	7164	TR55GP	3403	TR55	3951	.054
	V8 5.4L	GAS	PTR5C-13	7740	TR5AHX	94567	TR55IX	7164	TR55GP	3403	TR55	3951	.054
2005-04	V8 4.6L		PTR5C-13	7740	TR5AHX	94567	TR55IX	7164	TR55GP	3403	TR55	3951	.054
	V8 5.4L	CNG	PTR5F-11	6579	TR5AHX	94567	TR5IX	7397	TR5GP	3186	TR5	2238	.044
		GAS	PTR5C-13	7740	TR5AHX	94567	TR55IX	7164	TR55GP	3403	TR55	3951	.054
2003	V6 4.2L		TR55-1GP	7159			TR55-1IX	7316	TR55-1GP	7159	TR55-1	2683	.054
	V8 4.6L		PTR5C-13	7740	TR5AHX	94567	TR55IX	7164	TR55GP	3403	TR55	3951	.054
	V8 5.4L	CNG	PTR5F-11	6579	TR5AHX	94567	TR5IX	7397	TR5GP	3186	TR5	2238	.044
		GAS	PTR5C-13	7740	TR5AHX	94567	TR55IX	7164	TR55GP	3403	TR55	3951	.054
<b>E-250 Econoline</b>													
2002-00	V6 4.2L		TR55-1GP	7159			TR55-1IX	7316	TR55-1GP	7159	TR55-1	2683	.054
	V8 5.4L	CNG	PTR5F-11	6579	TR5AHX	94567	TR5IX	7397	TR5GP	3186	TR5	2238	.044
		GAS	PTR5C-13	7740	TR5AHX	94567	TR55IX	7164	TR55GP	3403	TR55	3951	.054
1999-98	V6 4.2L		TR55-1GP	7159			TR55-1IX	7316	TR55-1GP	7159	TR55-1	2683	.054

**Bold denotes NGK OE Manufacturer and/or OE Service Part**  
NOT BOLD denotes OE Equivalent Part

**Le texte en gras désigne une pièce d'équipement originale du manufacturier NGK et/ou pièce d'équipement originale de service**  
Le texte non en gras désigne une pièce d'équipement originale équivalente

Note: Due to different operating or engine conditions, alternate heat range plugs may be required.

Note: En raison de différences au niveau du fonctionnement ou des conditions du moteur, d'autres types de bougies avec variation de chaleur peuvent être nécessaires



Year	Cyl. L	Notes	Original Equipment		Ruthenium HX		Iridium IX		G-Power		V-Power		Gap
			Part	Stock	Part	Stock	Part	Stock	Part	Stock	Part	Stock	
<b>FORD (Cont'd)</b>													
<b>E-250 Econoline (Cont'd)</b>													
1999-98	V8 5.4L	BI-FUEL	PTR5C-13	7740	TR5AHX	94567	TR55IX	7164	TR55GP	3403	TR55	3951	.054
		CNG	PTR5F-11	6579	TR5AHX	94567	TR5IX	7397	TR5GP	3186	TR5	2238	.044
		GAS	PTR5C-13	7740	TR5AHX	94567	TR55IX	7164	TR55GP	3403	TR55	3951	.054
1997	V6 4.2L		PTR5C-13	7740			TR55IX	7164	TR55GP	3403	TR55	3951	.054
	V8 5.4L	CNG	PTR5F-11	6579	TR5AHX	94567	TR5IX	7397	TR5GP	3186	TR5	2238	.044
		GAS	PTR5C-13	7740	TR5AHX	94567	TR55IX	7164	TR55GP	3403	TR55	3951	.054
1996-95	L6 4.9L	BI-FUEL	WR4-1	4652							WR4-1	4652	.054
		GAS	WR4-1	4652							WR4-1	4652	.044
	V8 5.8L		UR5	2771			UR5IX	7177	UR5GP	3547	UR5	2771	.044
1994-92	L6 4.9L		WR4-1	4652							WR4-1	4652	.044
	V8 5.8L		UR5	2771			UR5IX	7177	UR5GP	3547	UR5	2771	.044
1991-89	L6 4.9L		WR4-1	4652							WR4-1	4652	.044
	V8 5.0L		UR45	6945			UR45IX	7559	UR45GP	3207	UR45	6945	.054
	V8 5.8L		UR5	2771			UR5IX	7177	UR5GP	3547	UR5	2771	.044
1988-87	L6 4.9L		WR4-1	4652							WR4-1	4652	.044
	V8 5.0L		UR4	6630			UR4IX	7401	UR4GP	2869	UR4	6630	.044
	V8 5.8L		UR5	2771			UR5IX	7177	UR5GP	3547	UR5	2771	.044
1986	L6 4.9L		WR5	2438			WR5IX	7510			WR5	2438	.044
	V8 5.0L		UR4	6630			UR4IX	7401	UR4GP	2869	UR4	6630	.044
	V8 5.8L		UR5	2771			UR5IX	7177	UR5GP	3547	UR5	2771	.044
1985	L6 4.9L	GAS	WR5	2438			WR5IX	7510			WR5	2438	.044
		LPG	WR5	2438			WR5IX	7510			WR5	2438	.034
	V8 5.0L		UR5	2771			UR5IX	7177	UR5GP	3547	UR5	2771	.044
	V8 5.8L	Vin G	UR4	6630			UR4IX	7401	UR4GP	2869	UR4	6630	.044
		Vin H	UR5	2771			UR5IX	7177	UR5GP	3547	UR5	2771	.044
<b>E-250 Econoline Club Wagon</b>													
1991-87	L6 4.9L		WR4-1	4652							WR4-1	4652	.044
	V8 5.8L		UR5	2771			UR5IX	7177	UR5GP	3547	UR5	2771	.044
	V8 7.5L		UR4	6630			UR4IX	7401	UR4GP	2869	UR4	6630	.044
1986	L6 4.9L		WR5	2438			WR5IX	7510			WR5	2438	.044
	V8 5.8L		UR5	2771			UR5IX	7177	UR5GP	3547	UR5	2771	.044
	V8 7.5L		UR4	6630			UR4IX	7401	UR4GP	2869	UR4	6630	.044
1985	L6 4.9L		WR5	2438			WR5IX	7510			WR5	2438	.044
	V8 5.8L	Vin G	UR4	6630			UR4IX	7401	UR4GP	2869	UR4	6630	.044
		Vin H	UR5	2771			UR5IX	7177	UR5GP	3547	UR5	2771	.044
V8 7.5L		UR4	6630			UR4IX	7401	UR4GP	2869	UR4	6630	.044	
<b>E-350 Club Wagon</b>													
2005	V8 5.4L	CNG	PTR5F-11	6579	TR5AHX	94567	TR5IX	7397	TR5GP	3186	TR5	2238	.044
		GAS	PTR5C-13	7740	TR5AHX	94567	TR55IX	7164	TR55GP	3403	TR55	3951	.054
	V8 6.0L	DIESEL	Y4002J	97190									
	V10 6.8L		PTR5C-13	7740	TR5AHX	94567	TR55IX	7164	TR55GP	3403	TR55	3951	.054
2004	V8 5.4L	CNG	PTR5F-11	6579	TR5AHX	94567	TR5IX	7397	TR5GP	3186	TR5	2238	.044
		GAS	PTR5C-13	7740	TR5AHX	94567	TR55IX	7164	TR55GP	3403	TR55	3951	.054
	V8 6.0L	DIESEL, From Engine Serial # 6155637	Y4002J	97190									
2003	V8 5.4L	CNG	PTR5F-11	6579	TR5AHX	94567	TR5IX	7397	TR5GP	3186	TR5	2238	.044
		GAS	PTR5C-13	7740	TR5AHX	94567	TR55IX	7164	TR55GP	3403	TR55	3951	.054
	V10 6.8L		PTR5C-13	7740	TR5AHX	94567	TR55IX	7164	TR55GP	3403	TR55	3951	.054
<b>E-350 Econoline</b>													
1998	V8 5.4L	BI-FUEL	PTR5C-13	7740	TR5AHX	94567	TR55IX	7164	TR55GP	3403	TR55	3951	.054
		CNG	PTR5F-11	6579	TR5AHX	94567	TR5IX	7397	TR5GP	3186	TR5	2238	.044
		GAS	PTR5C-13	7740	TR5AHX	94567	TR55IX	7164	TR55GP	3403	TR55	3951	.054
	V8 7.3L	DIESEL	Y1037J	97928									
V10 6.8L		PTR5C-13	7740	TR5AHX	94567	TR55IX	7164	TR55GP	3403	TR55	3951	.054	
1997	V8 5.4L	CNG	PTR5F-11	6579	TR5AHX	94567	TR5IX	7397	TR5GP	3186	TR5	2238	.044
		GAS	PTR5C-13	7740	TR5AHX	94567	TR55IX	7164	TR55GP	3403	TR55	3951	.054
	V8 7.3L	DIESEL	Y1037J	97928									



Year	Cyl. L	Notes	Original Equipment		Ruthenium HX		Iridium IX		G-Power		V-Power		Gap
			Part	Stock	Part	Stock	Part	Stock	Part	Stock	Part	Stock	
<b>FORD (Cont'd)</b>													
<b>E-350 Econoline (Cont'd)</b>													
1997	V10 6.8L		PTR5C-13	7740	TR5AHX	94567	TR55IX	7164	TR55GP	3403	TR55	3951	.054
1996	L6 4.9L	GAS	WR4-1	4652							WR4-1	4652	.044
	V8 5.8L		UR5	2771			UR5IX	7177	UR5GP	3547	UR5	2771	.044
	V8 7.3L	DIESEL	Y1037J	97928									
1995	V8 7.5L		UR4	6630			UR4IX	7401	UR4GP	2869	UR4	6630	.044
	L6 4.9L		WR4-1	4652							WR4-1	4652	.044
	V8 5.8L		UR5	2771			UR5IX	7177	UR5GP	3547	UR5	2771	.044
1994-87	V8 7.3L	DIESEL	Y1037J	97928									
	V8 7.5L		UR4	6630			UR4IX	7401	UR4GP	2869	UR4	6630	.044
	L6 4.9L		WR4-1	4652							WR4-1	4652	.044
1986	V8 5.8L		UR5	2771			UR5IX	7177	UR5GP	3547	UR5	2771	.044
	V8 7.5L		UR4	6630			UR4IX	7401	UR4GP	2869	UR4	6630	.044
	L6 4.9L		WR5	2438			WR5IX	7510			WR5	2438	.044
1985	V8 5.8L		UR5	2771			UR5IX	7177	UR5GP	3547	UR5	2771	.044
	V8 7.5L		UR4	6630			UR4IX	7401	UR4GP	2869	UR4	6630	.044
	L6 4.9L	GAS	WR5	2438			WR5IX	7510			WR5	2438	.044
	V8 5.8L	Vin G	UR4	6630			UR4IX	7401	UR4GP	2869	UR4	6630	.044
1985	V8 5.8L	Vin H	UR5	2771			UR5IX	7177	UR5GP	3547	UR5	2771	.044
	V8 7.5L		UR4	6630			UR4IX	7401	UR4GP	2869	UR4	6630	.044
<b>E-350 Econoline Club Wagon</b>													
2002-00	V8 5.4L	CNG	PTR5F-11	6579	TR5AHX	94567	TR5IX	7397	TR5GP	3186	TR5	2238	.044
	V8 5.4L	GAS	PTR5C-13	7740	TR5AHX	94567	TR55IX	7164	TR55GP	3403	TR55	3951	.054
	V8 7.3L	DIESEL	Y1037J	97928									
1999-98	V10 6.8L		PTR5C-13	7740	TR5AHX	94567	TR55IX	7164	TR55GP	3403	TR55	3951	.054
	V8 5.4L	BI-FUEL	PTR5C-13	7740	TR5AHX	94567	TR55IX	7164	TR55GP	3403	TR55	3951	.054
	V8 5.4L	CNG	PTR5F-11	6579	TR5AHX	94567	TR5IX	7397	TR5GP	3186	TR5	2238	.044
	V8 5.4L	GAS	PTR5C-13	7740	TR5AHX	94567	TR55IX	7164	TR55GP	3403	TR55	3951	.054
1997	V8 7.3L	DIESEL	Y1037J	97928									
	V10 6.8L		PTR5C-13	7740	TR5AHX	94567	TR55IX	7164	TR55GP	3403	TR55	3951	.054
	V8 5.4L	CNG	PTR5F-11	6579	TR5AHX	94567	TR5IX	7397	TR5GP	3186	TR5	2238	.044
	V8 5.4L	GAS	PTR5C-13	7740	TR5AHX	94567	TR55IX	7164	TR55GP	3403	TR55	3951	.054
1996	V8 7.3L	DIESEL	Y1037J	97928									
	V10 6.8L		PTR5C-13	7740	TR5AHX	94567	TR55IX	7164	TR55GP	3403	TR55	3951	.054
	L6 4.9L	BI-FUEL	WR4-1	4652							WR4-1	4652	.054
	L6 4.9L	GAS	WR4-1	4652							WR4-1	4652	.044
1995	V8 5.8L		UR5	2771			UR5IX	7177	UR5GP	3547	UR5	2771	.044
	V8 7.3L	DIESEL	Y1037J	97928									
	V8 7.5L		UR4	6630			UR4IX	7401	UR4GP	2869	UR4	6630	.044
1994-87	L6 4.9L		WR4-1	4652							WR4-1	4652	.044
	V8 5.8L		UR5	2771			UR5IX	7177	UR5GP	3547	UR5	2771	.044
	V8 7.5L		UR4	6630			UR4IX	7401	UR4GP	2869	UR4	6630	.044
1986	L6 4.9L		WR5	2438			WR5IX	7510			WR5	2438	.044
	V8 5.8L		UR5	2771			UR5IX	7177	UR5GP	3547	UR5	2771	.044
	V8 7.5L		UR4	6630			UR4IX	7401	UR4GP	2869	UR4	6630	.044
1985	L6 4.9L		WR5	2438			WR5IX	7510			WR5	2438	.044
	V8 5.8L	Vin G	UR4	6630			UR4IX	7401	UR4GP	2869	UR4	6630	.044
	V8 5.8L	Vin H	UR5	2771			UR5IX	7177	UR5GP	3547	UR5	2771	.044
1985	V8 7.5L		UR4	6630			UR4IX	7401	UR4GP	2869	UR4	6630	.044
	<b>E-350 Super Duty</b>												
2018	V10 6.8L		PTR5C-13	7740	TR5AHX	94567	TR55IX	7164	TR55GP	3403	TR55	3951	.054
2017	V8 6.2L	Dual Plug; 16 Req'd	PLTR6A-10G	3587	LTR6BH-X	90495	LTR6IX-11	6509	LTR6GP	90198			.044
	V10 6.8L		PTR5C-13	7740	TR5AHX	94567	TR55IX	7164	TR55GP	3403	TR55	3951	.054

**Bold denotes NGK OE Manufacturer and/or OE Service Part**  
NOT BOLD denotes OE Equivalent Part

**Le texte en gras désigne une pièce d'équipement originale du manufacturier NGK et/ou pièce d'équipement originale de service**  
Le texte non en gras désigne une pièce d'équipement originale équivalente

Note: Due to different operating or engine conditions, alternate heat range plugs may be required.

Note: En raison de différences au niveau du fonctionnement ou des conditions du moteur, d'autres types de bougies avec variation de chaleur peuvent être nécessaires





Year	Cyl. L	Notes	Original Equipment		Ruthenium HX		Iridium IX		G-Power		V-Power		Gap
			Part	Stock	Part	Stock	Part	Stock	Part	Stock	Part	Stock	
<b>FORD (Cont'd)</b>													
<b>E-350 Super Duty (Cont'd)</b>													
2016-11	V8 5.4L		PTR5C-13	7740	TR5AHX	94567	TR55IX	7164	TR55GP	3403	TR55	3951	.054
	V10 6.8L		PTR5C-13	7740	TR5AHX	94567	TR55IX	7164	TR55GP	3403	TR55	3951	.054
2010-09	V8 5.4L		PTR5C-13	7740	TR5AHX	94567	TR55IX	7164	TR55GP	3403	TR55	3951	.054
	V8 6.0L	DIESEL	Y4002J	97190									
	V10 6.8L		PTR5C-13	7740	TR5AHX	94567	TR55IX	7164	TR55GP	3403	TR55	3951	.054
2008-06	V8 5.4L	GAS	PTR5C-13	7740	TR5AHX	94567	TR55IX	7164	TR55GP	3403	TR55	3951	.054
	V8 6.0L	DIESEL	Y4002J	97190									
	V10 6.8L		PTR5C-13	7740	TR5AHX	94567	TR55IX	7164	TR55GP	3403	TR55	3951	.054
2005	V8 5.4L	CNG	PTR5F-11	6579	TR5AHX	94567	TR5IX	7397	TR5GP	3186	TR5	2238	.044
		GAS	PTR5C-13	7740	TR5AHX	94567	TR55IX	7164	TR55GP	3403	TR55	3951	.054
	V8 6.0L	DIESEL	Y4002J	97190									
	V10 6.8L		PTR5C-13	7740	TR5AHX	94567	TR55IX	7164	TR55GP	3403	TR55	3951	.054
2004	V8 5.4L	CNG	PTR5F-11	6579	TR5AHX	94567	TR5IX	7397	TR5GP	3186	TR5	2238	.044
		GAS	PTR5C-13	7740	TR5AHX	94567	TR55IX	7164	TR55GP	3403	TR55	3951	.054
	V8 6.0L	DIESEL, From Engine Serial # 6155637	Y4002J	97190									
	V10 6.8L		PTR5C-13	7740	TR5AHX	94567	TR55IX	7164	TR55GP	3403	TR55	3951	.054
2003-00	V8 5.4L	CNG	PTR5F-11	6579	TR5AHX	94567	TR5IX	7397	TR5GP	3186	TR5	2238	.044
		GAS	PTR5C-13	7740	TR5AHX	94567	TR55IX	7164	TR55GP	3403	TR55	3951	.054
	V8 7.3L	DIESEL	Y1037J	97928									
	V10 6.8L		PTR5C-13	7740	TR5AHX	94567	TR55IX	7164	TR55GP	3403	TR55	3951	.054
1999	V8 5.4L	BI-FUEL	PTR5C-13	7740	TR5AHX	94567	TR55IX	7164	TR55GP	3403	TR55	3951	.054
		CNG	PTR5F-11	6579	TR5AHX	94567	TR5IX	7397	TR5GP	3186	TR5	2238	.044
		GAS	PTR5C-13	7740	TR5AHX	94567	TR55IX	7164	TR55GP	3403	TR55	3951	.054
	V8 7.3L	DIESEL	Y1037J	97928									
	V10 6.8L		PTR5C-13	7740	TR5AHX	94567	TR55IX	7164	TR55GP	3403	TR55	3951	.054
<b>E-450 Econoline Super Duty</b>													
2002-00	V8 5.4L	CNG	PTR5F-11	6579	TR5AHX	94567	TR5IX	7397	TR5GP	3186	TR5	2238	.044
		GAS	PTR5C-13	7740	TR5AHX	94567	TR55IX	7164	TR55GP	3403	TR55	3951	.054
	V8 7.3L	DIESEL	Y1037J	97928									
	V10 6.8L		PTR5C-13	7740	TR5AHX	94567	TR55IX	7164	TR55GP	3403	TR55	3951	.054
1999	V8 7.3L	DIESEL	Y1037J	97928									
	V10 6.8L		PTR5C-13	7740	TR5AHX	94567	TR55IX	7164	TR55GP	3403	TR55	3951	.054
<b>E-450 Super Duty</b>													
2017	V10 6.8L		PTR5C-13	7740	TR5AHX	94567	TR55IX	7164	TR55GP	3403	TR55	3951	.054
2016-11	V8 5.4L		PTR5C-13	7740	TR5AHX	94567	TR55IX	7164	TR55GP	3403	TR55	3951	.054
	V10 6.8L		PTR5C-13	7740	TR5AHX	94567	TR55IX	7164	TR55GP	3403	TR55	3951	.054
2010-09	V8 5.4L		PTR5C-13	7740	TR5AHX	94567	TR55IX	7164	TR55GP	3403	TR55	3951	.054
	V8 6.0L	DIESEL	Y4002J	97190									
	V10 6.8L		PTR5C-13	7740	TR5AHX	94567	TR55IX	7164	TR55GP	3403	TR55	3951	.054
2008-06	V8 5.4L	GAS	PTR5C-13	7740	TR5AHX	94567	TR55IX	7164	TR55GP	3403	TR55	3951	.054
	V8 6.0L	DIESEL	Y4002J	97190									
	V10 6.8L		PTR5C-13	7740	TR5AHX	94567	TR55IX	7164	TR55GP	3403	TR55	3951	.054
2005	V8 6.0L	DIESEL	Y4002J	97190									
	V10 6.8L		PTR5C-13	7740	TR5AHX	94567	TR55IX	7164	TR55GP	3403	TR55	3951	.054
2004	V8 5.4L	CNG	PTR5F-11	6579	TR5AHX	94567	TR5IX	7397	TR5GP	3186	TR5	2238	.044
		GAS	PTR5C-13	7740	TR5AHX	94567	TR55IX	7164	TR55GP	3403	TR55	3951	.054
	V8 6.0L	DIESEL, From Engine Serial # 6155637	Y4002J	97190									
	V10 6.8L		PTR5C-13	7740	TR5AHX	94567	TR55IX	7164	TR55GP	3403	TR55	3951	.054
2003	V8 5.4L	CNG	PTR5F-11	6579	TR5AHX	94567	TR5IX	7397	TR5GP	3186	TR5	2238	.044
		GAS	PTR5C-13	7740	TR5AHX	94567	TR55IX	7164	TR55GP	3403	TR55	3951	.054
	V8 7.3L	DIESEL	Y1037J	97928									
	V10 6.8L		PTR5C-13	7740	TR5AHX	94567	TR55IX	7164	TR55GP	3403	TR55	3951	.054
<b>E-550 Econoline Super Duty</b>													
2002	V8 7.3L	DIESEL	Y1037J	97928									
	V10 6.8L		PTR5C-13	7740	TR5AHX	94567	TR55IX	7164	TR55GP	3403	TR55	3951	.054



Year	Cyl. L	Notes	Original Equipment		Ruthenium HX		Iridium IX		G-Power		V-Power		Gap
			Part	Stock	Part	Stock	Part	Stock	Part	Stock	Part	Stock	
<b>FORD (Cont'd)</b>													
<b>E-550 Super Duty</b>													
2003	V8 7.3L	DIESEL	Y1037J	97928									
	V10 6.8L		PTR5C-13	7740	TR5AHX	94567	TR55IX	7164	TR55GP	3403	TR55	3951	.054
<b>Econoline Super Duty</b>													
1999	V8 5.4L	CNG	PTR5F-11	6579	TR5AHX	94567	TR5IX	7397	TR5GP	3186	TR5	2238	.044
	V8 7.3L	DIESEL	Y1037J	97928									
	V10 6.8L		PTR5C-13	7740	TR5AHX	94567	TR55IX	7164	TR55GP	3403	TR55	3951	.054
1998-97	V8 5.4L	GAS	PTR5C-13	7740	TR5AHX	94567	TR55IX	7164	TR55GP	3403	TR55	3951	.054
	V8 7.3L	DIESEL	Y1037J	97928									
	V10 6.8L		PTR5C-13	7740	TR5AHX	94567	TR55IX	7164	TR55GP	3403	TR55	3951	.054
1996	V8 5.8L		UR5	2771			UR5IX	7177	UR5GP	3547	UR5	2771	.044
	V8 7.3L	DIESEL	Y1037J	97928									
	V8 7.5L		UR4	6630			UR4IX	7401	UR4GP	2869	UR4	6630	.044
<b>Edge</b>													
2017-15	L4 2.0L		<b>ILTR6G8G</b>	<b>96621</b>	LTR6BHx	90495	LTR6IX	94374	LTR6GP-8	94372			.032
	V6 2.7L		<b>ILTR7N8</b>	<b>95822</b>	LTR7BHx	95605							.032
	V6 3.5L		<b>LTR6BP13</b>	<b>94806</b>	LTR6AHx	91276	LTR6IX-11	6509					.052
2014	L4 2.0L		<b>LTR6DI-8</b>	<b>96588</b>	LTR6BHx	90495	LTR6IX	94374	LTR6GP-8	94372			.032
	V6 3.5L		<b>LTR6BP13</b>	<b>94806</b>	LTR6AHx	91276	LTR6IX-11	6509					.052
	V6 3.7L		<b>LTR6BP13</b>	<b>94806</b>	LTR6AHx	91276	LTR6IX-11	6509					.052
2013	L4 2.0L	From 5/31/2012	<b>LTR6DI-8</b>	<b>96588</b>	LTR6BHx	90495	LTR6IX	94374	LTR6GP-8	94372			.032
		To 5/30/2012	<b>ILTR6G8G</b>	<b>96621</b>	LTR6BHx	90495	LTR6IX	94374	LTR6GP-8	94372			.032
	V6 3.5L		<b>LTR6BP13</b>	<b>94806</b>	LTR6AHx	91276	LTR6IX-11	6509					.052
2012	L4 2.0L		<b>ILTR6G8G</b>	<b>96621</b>	LTR6BHx	90495	LTR6IX	94374	LTR6GP-8	94372			.032
	V6 3.5L		<b>LTR6BP13</b>	<b>94806</b>	LTR6AHx	91276	LTR6IX-11	6509					.052
	V6 3.7L		<b>LTR6BP13</b>	<b>94806</b>	LTR6AHx	91276	LTR6IX-11	6509					.052
2011	V6 3.5L		<b>ILTR5K13</b>	<b>90607</b>	LTR5AHx	90220	LTR5IX-11	4344	LTR5GP	5019			.052
	V6 3.7L		<b>LTR6BP13</b>	<b>94806</b>	LTR6AHx	91276	LTR6IX-11	6509					.052
2010-07	V6 3.5L		<b>ILTR5K13</b>	<b>90607</b>	LTR5AHx	90220	LTR5IX-11	4344	LTR5GP	5019			.052
<b>Escape</b>													
2017	L4 1.5L		<b>ILZNR8A7G</b>	<b>91924</b>									.028
	L4 2.0L		<b>LTR6DI-8</b>	<b>96588</b>	LTR6BHx	90495	LTR6IX	94374	LTR6GP-8	94372			.032
	L4 2.5L		<b>ILTR5K13</b>	<b>90607</b>	LTR5AHx	90220	LTR5IX-11	4344	LTR5GP	5019			.052
2016-13	L4 1.6L		<b>ILZTR6A8G</b>	<b>94769</b>	LTR6BHx	90495							.032
	L4 2.0L		<b>LTR6DI-8</b>	<b>96588</b>	LTR6BHx	90495	LTR6IX	94374	LTR6GP-8	94372			.032
	L4 2.5L		<b>ILTR5K13</b>	<b>90607</b>	LTR5AHx	90220	LTR5IX-11	4344	LTR5GP	5019			.052
2012-09	L4 2.5L		<b>ILTR5K13</b>	<b>90607</b>	LTR5AHx	90220	LTR5IX-11	4344	LTR5GP	5019			.052
	V6 3.0L		<b>TR5C-12</b>	<b>92838</b>	TR5AHx	94567	TR5IX	7397	TR5GP	3186	TR5	2238	.048
2008-06	L4 2.3L		<b>ITR5H13</b>	<b>97287</b>	TR5AHx	94567	TR55IX	7164	TR55GP	3403	TR55	3951	.052
	V6 3.0L		PTR5C-13	7740	TR5AHx	94567	TR55IX	7164	TR55GP	3403	TR55	3951	.054
2005	L4 2.3L	ELECTRIC/GAS	<b>ITR6F13</b>	<b>4477</b>	TR6AHx	92714	TR65IX	3692	TR6GP	5141	TR6	4177	.052
		GAS	<b>ITR5H13</b>	<b>97287</b>	TR5AHx	94567	TR55IX	7164	TR55GP	3403	TR55	3951	.052
2004-01	V6 3.0L		PTR5C-13	7740	TR5AHx	94567	TR55IX	7164	TR55GP	3403	TR55	3951	.054
	L4 2.0L		PTR5A-13	2467			LTR5IX-11	4344	LTR5GP	5019			.050
	V6 3.0L		PTR5C-13	7740	TR5AHx	94567	TR55IX	7164	TR55GP	3403	TR55	3951	.054
<b>Escort</b>													
2003	L4 2.0L		PTR5A-13	2467			LTR5IX-11	4344	LTR5GP	5019			.050
2002-98	L4 2.0L	DOHC	PTR5A-13	2467			LTR5IX-11	4344	LTR5GP	5019			.050
		SOHC	TR55-1GP	7159			TR55-1IX	7316	TR55-1GP	7159	TR55-1	2683	.054
1997	L4 2.0L		TR55-1GP	7159			TR55-1IX	7316	TR55-1GP	7159	TR55-1	2683	.054
1996	L4 1.8L		BKR6E-11	2756			BKR6EIX-11	3764	BKR6EGP	7092	BKR6E-11	2756	.044
	L4 1.9L		TR55-1	2683			TR55-1IX	7316	TR55-1GP	7159	TR55-1	2683	.054
1995	L4 1.8L		BKR6ES-11	5553			BKR6EIX-11	3764	BKR6EGP	7092	BKR6E-11	2756	.044
	L4 1.9L		TR55-1	2683			TR55-1IX	7316	TR55-1GP	7159	TR55-1	2683	.054
1994-91	L4 1.8L		BKR6E-11	2756			BKR6EIX-11	3764	BKR6EGP	7092	BKR6E-11	2756	.044
	L4 1.9L		TR55-1	2683			TR55-1IX	7316	TR55-1GP	7159	TR55-1	2683	.054
1990-88	L4 1.9L		TR5-1	7060			TR5-1IX	7243	TR5-1GP	3716	TR5-1	7060	.044

**Bold denotes NGK OE Manufacturer and/or OE Service Part**  
NOT BOLD denotes OE Equivalent Part

**Le texte en gras désigne une pièce d'équipement originale du manufacturier NGK et/ou pièce d'équipement originale de service**  
Le texte non en gras désigne une pièce d'équipement originale équivalente

Note: Due to different operating or engine conditions, alternate heat range plugs may be required.

Note: En raison de différences au niveau du fonctionnement ou des conditions du moteur, d'autres types de bougies avec variation de chaleur peuvent être nécessaires



Year	Cyl. L	Notes	Original Equipment		Ruthenium HX		Iridium IX		G-Power		V-Power		Gap
			Part	Stock	Part	Stock	Part	Stock	Part	Stock	Part	Stock	
<b>FORD (Cont'd)</b>													
<b>Escort (Cont'd)</b>													
1987-86	L4 1.9L		TR5-1	7060			TR5-1IX	7243	TR5-1GP	3716	TR5-1	7060	.044
	L4 2.0L	DIESEL	Y-107R	1229									
1985	L4 1.6L	Naturally Aspirated	TR5-1	7060			TR5-1IX	7243	TR5-1GP	3716	TR5-1	7060	.044
		Turbo	TR5	2238			TR5IX	7397	TR5GP	3186	TR5	2238	.044
	L4 1.9L		TR5-1	7060			TR5-1IX	7243	TR5-1GP	3716	TR5-1	7060	.044
	L4 2.0L	DIESEL	Y-107R	1229									
<b>Excursion</b>													
2005	V8 5.4L		PTR5C-13	7740	TR5AHX	94567	TR55IX	7164	TR55GP	3403	TR55	3951	.054
	V8 6.0L	DIESEL	Y4002J	97190									
	V10 6.8L		PTR5C-13	7740	TR5AHX	94567	TR55IX	7164	TR55GP	3403	TR55	3951	.054
2004	V8 5.4L		PTR5C-13	7740	TR5AHX	94567	TR55IX	7164	TR55GP	3403	TR55	3951	.054
	V8 6.0L	DIESEL, From Engine Serial # 6155637	Y4002J	97190									
	V10 6.8L		PTR5C-13	7740	TR5AHX	94567	TR55IX	7164	TR55GP	3403	TR55	3951	.054
2003-00	V8 5.4L		PTR5C-13	7740	TR5AHX	94567	TR55IX	7164	TR55GP	3403	TR55	3951	.054
	V8 7.3L	DIESEL	Y1037J	97928									
	V10 6.8L		PTR5C-13	7740	TR5AHX	94567	TR55IX	7164	TR55GP	3403	TR55	3951	.054
<b>EXP</b>													
1988-86	L4 1.9L		TR5-1	7060			TR5-1IX	7243	TR5-1GP	3716	TR5-1	7060	.044
1985	L4 1.6L	Naturally Aspirated	TR5-1	7060			TR5-1IX	7243	TR5-1GP	3716	TR5-1	7060	.044
		Turbo	TR5	2238			TR5IX	7397	TR5GP	3186	TR5	2238	.044
<b>Expedition</b>													
2017-15	V6 3.5L		<b>LTR6CI-8</b>	<b>97177</b>	LTR6BHX	90495	LTR6IX	94374	LTR6GP-8	94372			.032
2014-09	V8 5.4L		<b>PZAR6A11H</b>	<b>5507</b>			ZNAR6AIX-11	372	ZNAR6AGP	1698			.044
2008	V8 5.4L	New Eng. Design w/Brown Coil Boots ONLY. NO NGK Part # for Old Eng. Design (w/Black Coil Boots)	<b>PZAR6A11H</b>	<b>5507</b>			ZNAR6AIX-11	372	ZNAR6AGP	1698			.044
2004-00	V8 4.6L		PTR5C-13	7740	TR5AHX	94567	TR55IX	7164	TR55GP	3403	TR55	3951	.054
	V8 5.4L		PTR5C-13	7740	TR5AHX	94567	TR55IX	7164	TR55GP	3403	TR55	3951	.054
1999-97	V8 4.6L		PTR5C-13	7740			TR55IX	7164	TR55GP	3403	TR55	3951	.054
	V8 5.4L		PTR5C-13	7740	TR5AHX	94567	TR55IX	7164	TR55GP	3403	TR55	3951	.054
<b>Explorer</b>													
2017-16	L4 2.3L		<b>LTR6DI-8</b>	<b>96588</b>	LTR6BHX	90495	LTR6IX	94374	LTR6GP-8	94372			.032
	V6 3.5L	Naturally Aspirated	<b>LTR6BP13</b>	<b>94806</b>	LTR6AHX	91276	LTR6IX-11	6509					.052
		Turbo		<b>LTR6CI-8</b>	<b>97177</b>	LTR6BHX	90495	LTR6IX	94374	LTR6GP-8	94372		
2015-14	L4 2.0L		<b>LTR6DI-8</b>	<b>96588</b>	LTR6BHX	90495	LTR6IX	94374	LTR6GP-8	94372			.032
	V6 3.5L	Naturally Aspirated	<b>LTR6BP13</b>	<b>94806</b>	LTR6AHX	91276	LTR6IX-11	6509					.052
		Turbo		<b>LTR6CI-8</b>	<b>97177</b>	LTR6BHX	90495	LTR6IX	94374	LTR6GP-8	94372		
2013	L4 2.0L		<b>ILTR6G8G</b>	<b>96621</b>	LTR6BHX	90495	LTR6IX	94374	LTR6GP-8	94372			.032
	V6 3.5L	Naturally Aspirated	<b>LTR6BP13</b>	<b>94806</b>	LTR6AHX	91276	LTR6IX-11	6509					.052
		Turbo		<b>LTR6CI-8</b>	<b>97177</b>	LTR6BHX	90495	LTR6IX	94374	LTR6GP-8	94372		
2012	L4 2.0L		<b>ILTR6G8G</b>	<b>96621</b>	LTR6BHX	90495	LTR6IX	94374	LTR6GP-8	94372			.032
	V6 3.5L		<b>LTR6BP13</b>	<b>94806</b>	LTR6AHX	91276	LTR6IX-11	6509					.052
2011	V6 3.5L		<b>LTR6BP13</b>	<b>94806</b>	LTR6AHX	91276	LTR6IX-11	6509					.052
	V6 4.0L		TR55-1	2683			TR55-1IX	7316	TR55-1GP	7159	TR55-1	2683	.054
2010-09	V8 4.6L		<b>PZAR6A11H</b>	<b>5507</b>			ZNAR6AIX-11	372	ZNAR6AGP	1698			.044
2008	V6 4.0L		TR55-1	2683			TR55-1IX	7316	TR55-1GP	7159	TR55-1	2683	.054
	V8 4.6L	New engine style with brown coil boots only (NGK N/A for old engine design with black coil boots)	<b>PZAR6A11H</b>	<b>5507</b>			ZNAR6AIX-11	372	ZNAR6AGP	1698			.044
2007-06	V6 4.0L		TR55-1	2683			TR55-1IX	7316	TR55-1GP	7159	TR55-1	2683	.054
2005-02	V6 4.0L		PTR5C-13	7740			TR55IX	7164	TR55GP	3403	TR55	3951	.054
	V8 4.6L		PTR5C-13	7740	TR5AHX	94567	TR55IX	7164	TR55GP	3403	TR55	3951	.054
2001-97	V6 4.0L		PTR5C-13	7740			TR55IX	7164	TR55GP	3403	TR55	3951	.054
	V8 5.0L		PTR5C-13	7740			TR55IX	7164	TR55GP	3403	TR55	3951	.054
1996	V6 4.0L		PTR5C-13	7740			TR55IX	7164	TR55GP	3403	TR55	3951	.054



Year	Cyl. L	Notes	Original Equipment		Ruthenium HX		Iridium IX		G-Power		V-Power		Gap
			Part	Stock	Part	Stock	Part	Stock	Part	Stock	Part	Stock	
<b>FORD (Cont'd)</b>													
<b>Explorer (Cont'd)</b>													
1996	V8 5.0L		TR55	3951			TR55IX	7164	TR55GP	3403	TR55	3951	.054
1995-91	V6 4.0L		PTR5C-13	7740			TR55IX	7164	TR55GP	3403	TR55	3951	.054
<b>Explorer Sport</b>													
2003-01	V6 4.0L		PTR5C-13	7740			TR55IX	7164	TR55GP	3403	TR55	3951	.054
<b>Explorer Sport Trac</b>													
2010-09	V6 4.0L		TR55-1	2683			TR55-1IX	7316	TR55-1GP	7159	TR55-1	2683	.054
	V8 4.6L		<b>PZAR6A11H</b>	<b>5507</b>			ZNAR6AIX-11	372	ZNAR6AGP	1698			.044
2008	V6 4.0L		TR55-1	2683			TR55-1IX	7316	TR55-1GP	7159	TR55-1	2683	.054
	V8 4.6L	New engine style with brown coil boots only (NGK N/A for old engine design with black coil boots)	<b>PZAR6A11H</b>	<b>5507</b>			ZNAR6AIX-11	372	ZNAR6AGP	1698			.044
2007	V6 4.0L		TR55-1	2683			TR55-1IX	7316	TR55-1GP	7159	TR55-1	2683	.054
2005-01	V6 4.0L		PTR5C-13	7740			TR55IX	7164	TR55GP	3403	TR55	3951	.054
<b>F53</b>													
2018-11	V10 6.8L		<b>PZAR6A11H</b>	<b>5507</b>			ZNAR6AIX-11	372	ZNAR6AGP	1698			.044
2009	V10 6.8L		<b>PZAR6A11H</b>	<b>5507</b>			ZNAR6AIX-11	372	ZNAR6AGP	1698			.044
2008	V10 6.8L	New Eng. Design w/Brown Coil Boots ONLY. NO NGK Part # for Old Eng. Design (w/Black Coil Boots)	<b>PZAR6A11H</b>	<b>5507</b>			ZNAR6AIX-11	372	ZNAR6AGP	1698			.044
2004-99	V10 6.8L		PTR5C-13	7740	TR5AHX	94567	TR55IX	7164	TR55GP	3403	TR55	3951	.054
1997	V8 7.5L		UR5	2771			UR5IX	7177	UR5GP	3547	UR5	2771	.044
1996-88	V8 7.5L		UR4	6630			UR4IX	7401	UR4GP	2869	UR4	6630	.044
<b>F59</b>													
2018-11	V10 6.8L		<b>PZAR6A11H</b>	<b>5507</b>			ZNAR6AIX-11	372	ZNAR6AGP	1698			.044
1997-96	V8 7.3L	DIESEL	Y1037J	97928									
1995-93	V8 7.3L	DIESEL, Turbo	Y1037J	97928									
<b>F650</b>													
2013-12	V10 6.8L		<b>PZAR6A11H</b>	<b>5507</b>			ZNAR6AIX-11	372	ZNAR6AGP	1698			.044
2008-05	V8 6.0L	DIESEL	Y4002J	97190									
2004	V8 6.0L	DIESEL, From Engine Serial # 6155637	Y4002J	97190									
<b>F750</b>													
2008-05	V8 6.0L	DIESEL	Y4002J	97190									
2004	V8 6.0L	DIESEL, From Engine Serial # 6155637	Y4002J	97190									
<b>F-150</b>													
2018	V8 5.0L		<b>LTR7CP13</b>	<b>94862</b>	LTR7BHX	95605							.052
2017	V6 2.7L		<b>ILTR7N8</b>	<b>95822</b>	LTR7BHX	95605							.032
	V6 3.5L	Naturally Aspirated	<b>LTR6BP13</b>	<b>94806</b>	LTR6AHX	91276	LTR6IX-11	6509					.052
		Turbo				LTR6BHX	90495	LTR6IX	94374	LTR6GP-8	94372		.032
	V8 5.0L		<b>LTR6DP13</b>	<b>90374</b>	LTR6AHX	91276	LTR6IX-11	6509					.052
2016-15	V6 2.7L		<b>ILTR7N8</b>	<b>95822</b>	LTR7BHX	95605							.032
	V6 3.5L	Naturally Aspirated	<b>LTR6BP13</b>	<b>94806</b>	LTR6AHX	91276	LTR6IX-11	6509					.052
		Turbo		<b>LTR6CI-8</b>	<b>97177</b>	LTR6BHX	90495	LTR6IX	94374	LTR6GP-8	94372		.032
V8 5.0L		<b>LTR6DP13</b>	<b>90374</b>	LTR6AHX	91276	LTR6IX-11	6509					.052	
2014-11	V6 3.5L		<b>LTR6CI-8</b>	<b>97177</b>	LTR6BHX	90495	LTR6IX	94374	LTR6GP-8	94372			.032
	V6 3.7L		<b>LTR6BP13</b>	<b>94806</b>	LTR6AHX	91276	LTR6IX-11	6509					.052
	V8 5.0L		<b>LTR6AI13</b>	<b>95853</b>	LTR6AHX	91276	LTR6IX-11	6509					.052
	V8 6.2L	Dual Plug; 16 Req'd	PLTR6A-10G	3587	LTR6BHX	90495	LTR6IX-11	6509	LTR6GP	90198			.044
2010	V8 4.6L	Vin 8, 24Valves	<b>PZAR6A11H</b>	<b>5507</b>			ZNAR6AIX-11	372	ZNAR6AGP	1698			.044
		Vin W, 16Valves	TR55	3951	TR5AHX	94567	TR55IX	7164	TR55GP	3403	TR55	3951	.054
	V8 5.4L		<b>PZAR6A11H</b>	<b>5507</b>			ZNAR6AIX-11	372	ZNAR6AGP	1698			.044
	V8 6.2L	Dual Plug; 16 Req'd	PLTR6A-10G	3587	LTR6BHX	90495	LTR6IX-11	6509	LTR6GP	90198			.044
2009	V8 4.6L	Vin 8, 24Valves	<b>PZAR6A11H</b>	<b>5507</b>			ZNAR6AIX-11	372	ZNAR6AGP	1698			.044
		Vin W, 16Valves	TR55	3951	TR5AHX	94567	TR55IX	7164	TR55GP	3403	TR55	3951	.054
	V8 5.4L		<b>PZAR6A11H</b>	<b>5507</b>			ZNAR6AIX-11	372	ZNAR6AGP	1698			.044

**Bold denotes NGK OE Manufacturer and/or OE Service Part**  
NOT BOLD denotes OE Equivalent Part

**Le texte en gras désigne une pièce d'équipement originale du manufacturier NGK et/ou pièce d'équipement originale de service**  
Le texte non en gras désigne une pièce d'équipement originale équivalente

Note: Due to different operating or engine conditions, alternate heat range plugs may be required.

Note: En raison de différences au niveau du fonctionnement ou des conditions du moteur, d'autres types de bougies avec variation de chaleur peuvent être nécessaires



Year	Cyl. L	Notes	Original Equipment		Ruthenium HX		Iridium IX		G-Power		V-Power		Gap
			Part	Stock	Part	Stock	Part	Stock	Part	Stock	Part	Stock	
<b>FORD (Cont'd)</b>													
<b>F-150 (Cont'd)</b>													
2008	V6 4.2L		TR55-1GP	7159			TR55-1IX	7316	TR55-1GP	7159	TR55-1	2683	.054
	V8 4.6L		PTR5C-13	7740	TR5AHX	94567	TR55IX	7164	TR55GP	3403	TR55	3951	.054
	V8 5.4L	New Eng. Design w/Brown Coil Boots ONLY. NO NGK Part # for Old Eng. Design (w/Black Coil Boots)	<b>PZNAR6A11H</b>	<b>5507</b>			ZNAR6AIX-11	372	ZNAR6AGP	1698			
2007-05	V6 4.2L		TR55-1GP	7159			TR55-1IX	7316	TR55-1GP	7159	TR55-1	2683	.054
	V8 4.6L		PTR5C-13	7740	TR5AHX	94567	TR55IX	7164	TR55GP	3403	TR55	3951	.054
2004	V8 4.6L		PTR5C-13	7740	TR5AHX	94567	TR55IX	7164	TR55GP	3403	TR55	3951	.054
2003-00	V6 4.2L		TR55-1GP	7159			TR55-1IX	7316	TR55-1GP	7159	TR55-1	2683	.054
	V8 4.6L		PTR5C-13	7740	TR5AHX	94567	TR55IX	7164	TR55GP	3403	TR55	3951	.054
	V8 5.4L	BI-FUEL, Naturally Aspirated	PTR5C-13	7740	TR5AHX	94567	TR55IX	7164	TR55GP	3403	TR55	3951	.054
		CNG, Naturally Aspirated	PTR5F-11	6579	TR5AHX	94567	TR5IX	7397	TR5GP	3186	TR5	2238	.044
		GAS, Naturally Aspirated	PTR5C-13	7740	TR5AHX	94567	TR55IX	7164	TR55GP	3403	TR55	3951	.054
	GAS, Supercharged	PTR6D-13	5598			TR6IX	3689	TR6GP	5141	TR6	4177	.044	
1999	V6 4.2L		TR55-1GP	7159			TR55-1IX	7316	TR55-1GP	7159	TR55-1	2683	.054
	V8 4.6L		PTR5C-13	7740			TR55IX	7164	TR55GP	3403	TR55	3951	.054
	V8 5.4L	BI-FUEL, Naturally Aspirated	PTR5C-13	7740	TR5AHX	94567	TR55IX	7164	TR55GP	3403	TR55	3951	.054
		GAS, Naturally Aspirated	PTR5C-13	7740	TR5AHX	94567	TR55IX	7164	TR55GP	3403	TR55	3951	.054
	GAS, Supercharged	PTR6D-13	5598			TR6IX	3689	TR6GP	5141	TR6	4177	.044	
1998	V6 4.2L		TR55-1GP	7159			TR55-1IX	7316	TR55-1GP	7159	TR55-1	2683	.054
	V8 4.6L		PTR5C-13	7740			TR55IX	7164	TR55GP	3403	TR55	3951	.054
	V8 5.4L	BI-FUEL	PTR5C-13	7740	TR5AHX	94567	TR55IX	7164	TR55GP	3403	TR55	3951	.054
		CNG	PTR5F-11	6579	TR5AHX	94567	TR5IX	7397	TR5GP	3186	TR5	2238	.044
	GAS	PTR5C-13	7740	TR5AHX	94567	TR55IX	7164	TR55GP	3403	TR55	3951	.054	
1997	V6 4.2L		PTR5C-13	7740			TR55IX	7164	TR55GP	3403	TR55	3951	.054
	V8 4.6L		PTR5C-13	7740			TR55IX	7164	TR55GP	3403	TR55	3951	.054
	V8 5.4L	GAS	PTR5C-13	7740	TR5AHX	94567	TR55IX	7164	TR55GP	3403	TR55	3951	.054
1996	L6 4.9L	BI-FUEL	WR4-1	4652							WR4-1	4652	.054
		GAS	WR4-1	4652							WR4-1	4652	.044
	V8 5.0L		UR45	6945			UR45IX	7559	UR45GP	3207	UR45	6945	.054
	V8 5.8L		UR5	2771			UR5IX	7177	UR5GP	3547	UR5	2771	.044
1995	L6 4.9L	BI-FUEL	WR4-1	4652							WR4-1	4652	.054
		GAS	WR4-1	4652							WR4-1	4652	.044
	V8 5.0L		UR45	6945			UR45IX	7559	UR45GP	3207	UR45	6945	.054
	V8 5.8L	Vin H	UR5	2771			UR5IX	7177	UR5GP	3547	UR5	2771	.044
	Vin R	TR5	2238			TR5IX	7397	TR5GP	3186	TR5	2238	.044	
1994-93	L6 4.9L		WR4-1	4652							WR4-1	4652	.044
	V8 5.0L		UR45	6945			UR45IX	7559	UR45GP	3207	UR45	6945	.054
	V8 5.8L	Vin H	UR5	2771			UR5IX	7177	UR5GP	3547	UR5	2771	.044
		Vin R	TR5	2238			TR5IX	7397	TR5GP	3186	TR5	2238	.044
1992-89	L6 4.9L		WR4-1	4652							WR4-1	4652	.044
	V8 5.0L		UR45	6945			UR45IX	7559	UR45GP	3207	UR45	6945	.054
	V8 5.8L		UR5	2771			UR5IX	7177	UR5GP	3547	UR5	2771	.044
1988-87	L6 4.9L		WR4-1	4652							WR4-1	4652	.044
	V8 5.0L		UR4	6630			UR4IX	7401	UR4GP	2869	UR4	6630	.044
	V8 5.8L		UR5	2771			UR5IX	7177	UR5GP	3547	UR5	2771	.044
1986	L6 4.9L		WR5	2438			WR5IX	7510			WR5	2438	.044
	V8 5.0L		UR4	6630			UR4IX	7401	UR4GP	2869	UR4	6630	.044
	V8 5.8L		UR5	2771			UR5IX	7177	UR5GP	3547	UR5	2771	.044
1985	L6 4.9L	GAS	WR5	2438			WR5IX	7510			WR5	2438	.044
		LPG	WR5	2438			WR5IX	7510			WR5	2438	.034
	V8 5.0L	CARB	UR5	2771			UR5IX	7177	UR5GP	3547	UR5	2771	.044
		FI	UR4	6630			UR4IX	7401	UR4GP	2869	UR4	6630	.044





Year	Cyl. L	Notes	Original Equipment		Ruthenium HX		Iridium IX		G-Power		V-Power		Gap
			Part	Stock	Part	Stock	Part	Stock	Part	Stock	Part	Stock	
<b>FORD (Cont'd)</b>													
<b>F-150 (Cont'd)</b>													
1985	V8 5.8L	Vin G	UR4	6630			UR4IX	7401	UR4GP	2869	UR4	6630	.044
		Vin H	UR5	2771			UR5IX	7177	UR5GP	3547	UR5	2771	.044
<b>F-150 Heritage</b>													
2004	V6 4.2L		TR55-1GP	7159			TR55-1IX	7316	TR55-1GP	7159	TR55-1	2683	.054
	V8 4.6L		PTR5C-13	7740	TR5AHX	94567	TR55IX	7164	TR55GP	3403	TR55	3951	.054
	V8 5.4L	BI-FUEL, Naturally Aspirated, 16Valves, Carryover Model	PTR5C-13	7740	TR5AHX	94567	TR55IX	7164	TR55GP	3403	TR55	3951	.054
		CNG, Naturally Aspirated, 16Valves, Carryover Model	PTR5F-11	6579	TR5AHX	94567	TR5IX	7397	TR5GP	3186	TR55	3951	.044
	GAS, Supercharged, 16Valves, Carryover Model	PTR6D-13	5598			TR6IX	3689	TR6GP	5141	TR6	4177	.044	
<b>F-250</b>													
1999-98	V8 4.6L		PTR5C-13	7740			TR55IX	7164	TR55GP	3403	TR55	3951	.054
	V8 5.4L	BI-FUEL	PTR5C-13	7740	TR5AHX	94567	TR55IX	7164	TR55GP	3403	TR55	3951	.054
		CNG	PTR5F-11	6579	TR5AHX	94567	TR5IX	7397	TR5GP	3186	TR5	2238	.044
		GAS	PTR5C-13	7740	TR5AHX	94567	TR55IX	7164	TR55GP	3403	TR55	3951	.054
1997	V8 4.6L		PTR5C-13	7740			TR55IX	7164	TR55GP	3403	TR55	3951	.054
	V8 5.4L	CNG	PTR5F-11	6579	TR5AHX	94567	TR5IX	7397	TR5GP	3186	TR5	2238	.044
		GAS	PTR5C-13	7740	TR5AHX	94567	TR55IX	7164	TR55GP	3403	TR55	3951	.054
1996-95	L6 4.9L	BI-FUEL	WR4-1	4652							WR4-1	4652	.054
		GAS	WR4-1	4652							WR4-1	4652	.044
	V8 5.0L		UR45	6945			UR45IX	7559	UR45GP	3207	UR45	6945	.054
	V8 5.8L		UR5	2771			UR5IX	7177	UR5GP	3547	UR5	2771	.044
	V8 7.3L	DIESEL	Y1037J	97928									
	V8 7.5L		UR4	6630			UR4IX	7401	UR4GP	2869	UR4	6630	.044
1994-93	L6 4.9L		WR4-1	4652							WR4-1	4652	.044
	V8 5.0L		UR45	6945			UR45IX	7559	UR45GP	3207	UR45	6945	.054
	V8 5.8L		UR5	2771			UR5IX	7177	UR5GP	3547	UR5	2771	.044
	V8 7.3L	DIESEL, Turbo	Y1037J	97928									
	V8 7.5L		UR4	6630			UR4IX	7401	UR4GP	2869	UR4	6630	.044
1992-89	L6 4.9L		WR4-1	4652							WR4-1	4652	.044
	V8 5.0L		UR45	6945			UR45IX	7559	UR45GP	3207	UR45	6945	.054
	V8 5.8L		UR5	2771			UR5IX	7177	UR5GP	3547	UR5	2771	.044
	V8 7.5L		UR4	6630			UR4IX	7401	UR4GP	2869	UR4	6630	.044
1988-87	L6 4.9L		WR4-1	4652							WR4-1	4652	.044
	V8 5.0L		UR4	6630			UR4IX	7401	UR4GP	2869	UR4	6630	.044
	V8 5.8L		UR5	2771			UR5IX	7177	UR5GP	3547	UR5	2771	.044
	V8 7.5L		UR4	6630			UR4IX	7401	UR4GP	2869	UR4	6630	.044
1986	L6 4.9L		WR5	2438			WR5IX	7510			WR5	2438	.044
	V8 5.0L		UR4	6630			UR4IX	7401	UR4GP	2869	UR4	6630	.044
	V8 5.8L		UR5	2771			UR5IX	7177	UR5GP	3547	UR5	2771	.044
	V8 7.5L		UR4	6630			UR4IX	7401	UR4GP	2869	UR4	6630	.044
1985	L6 4.9L	GAS	WR5	2438			WR5IX	7510			WR5	2438	.044
		LPG	WR5	2438			WR5IX	7510			WR5	2438	.034
	V8 5.0L	CARB	UR5	2771			UR5IX	7177	UR5GP	3547	UR5	2771	.044
		FI	UR4	6630			UR4IX	7401	UR4GP	2869	UR4	6630	.044
	V8 5.8L	Vin G	UR4	6630			UR4IX	7401	UR4GP	2869	UR4	6630	.044
		Vin H	UR5	2771			UR5IX	7177	UR5GP	3547	UR5	2771	.044
	V8 7.5L		UR4	6630			UR4IX	7401	UR4GP	2869	UR4	6630	.044
<b>F-250 HD</b>													
1997	V8 5.8L		UR5	2771			UR5IX	7177	UR5GP	3547	UR5	2771	.044
	V8 7.3L	DIESEL	Y1037J	97928									
	V8 7.5L		UR5	2771			UR5IX	7177	UR5GP	3547	UR5	2771	.044
<b>F-250 Super Duty</b>													
2017-11	V8 6.2L	Dual Plug; 16 Req'd	PLTR6A-10G	3587	LTR6BHX	90495	LTR6IX-11	6509	LTR6GP	90198			.044
2010-09	V8 5.4L		<b>PZNAR6A11H</b>	<b>5507</b>			ZNAR6AIX-11	372	ZNAR6AGP	1698			.044

**Bold denotes NGK OE Manufacturer and/or OE Service Part**  
NOT BOLD denotes OE Equivalent Part

**Le texte en gras désigne une pièce d'équipement originale du manufacturier NGK et/ou pièce d'équipement originale de service**  
Le texte non en gras désigne une pièce d'équipement originale équivalente

Note: Due to different operating or engine conditions, alternate heat range plugs may be required.

Note: En raison de différences au niveau du fonctionnement ou des conditions du moteur, d'autres types de bougies avec variation de chaleur peuvent être nécessaires



Year	Cyl. L	Notes	Original Equipment		Ruthenium HX		Iridium IX		G-Power		V-Power		Gap
			Part	Stock	Part	Stock	Part	Stock	Part	Stock	Part	Stock	
<b>FORD (Cont'd)</b>													
<b>F-250 Super Duty (Cont'd)</b>													
2010-09	V8 6.4L	DIESEL	<b>Y-408JS</b>	<b>5616</b>									
	V10 6.8L		<b>PZNR6A11H</b>	<b>5507</b>			ZNAR6AIX-11	372	ZNAR6AGP	1698			.044
2008	V8 5.4L	New Eng. Design w/Brown Coil Boots ONLY. NO NGK Part # for Old Eng. Design (w/Black Coil Boots)	<b>PZNR6A11H</b>	<b>5507</b>			ZNAR6AIX-11	372	ZNAR6AGP	1698			.044
	V8 6.4L	DIESEL	<b>Y-408JS</b>	<b>5616</b>									
	V10 6.8L	New Eng. Design w/Brown Coil Boots ONLY. NO NGK Part # for Old Eng. Design (w/Black Coil Boots)	<b>PZNR6A11H</b>	<b>5507</b>			ZNAR6AIX-11	372	ZNAR6AGP	1698			.044
2007-05	V8 6.0L	DIESEL	Y4002J	97190									
2004	V8 5.4L	GAS	PTR5C-13	7740	TR5AHX	94567	TR55IX	7164	TR55GP	3403	TR55	3951	.054
	V8 6.0L	DIESEL, From Engine Serial # 6155637	Y4002J	97190									
	V10 6.8L		PTR5C-13	7740	TR5AHX	94567	TR55IX	7164	TR55GP	3403	TR55	3951	.054
2003-99	V8 5.4L	GAS	PTR5C-13	7740	TR5AHX	94567	TR55IX	7164	TR55GP	3403	TR55	3951	.054
	V8 7.3L	DIESEL	Y1037J	97928									
	V10 6.8L		PTR5C-13	7740	TR5AHX	94567	TR55IX	7164	TR55GP	3403	TR55	3951	.054
<b>F-350</b>													
1997	V8 5.8L		UR5	2771			UR5IX	7177	UR5GP	3547	UR5	2771	.044
	V8 7.3L	DIESEL	Y1037J	97928									
	V8 7.5L		UR5	2771			UR5IX	7177	UR5GP	3547	UR5	2771	.044
1996-95	L6 4.9L		WR4-1	4652							WR4-1	4652	.044
	V8 5.8L		UR5	2771			UR5IX	7177	UR5GP	3547	UR5	2771	.044
	V8 7.3L	DIESEL	Y1037J	97928									
	V8 7.5L		UR4	6630			UR4IX	7401	UR4GP	2869	UR4	6630	.044
1994-93	L6 4.9L		WR4-1	4652							WR4-1	4652	.044
	V8 5.8L		UR5	2771			UR5IX	7177	UR5GP	3547	UR5	2771	.044
	V8 7.3L	DIESEL, Turbo	Y1037J	97928									
	V8 7.5L		UR4	6630			UR4IX	7401	UR4GP	2869	UR4	6630	.044
1992-87	L6 4.9L		WR4-1	4652							WR4-1	4652	.044
	V8 5.8L		UR5	2771			UR5IX	7177	UR5GP	3547	UR5	2771	.044
	V8 7.5L		UR4	6630			UR4IX	7401	UR4GP	2869	UR4	6630	.044
1986	L6 4.9L		WR5	2438			WR5IX	7510			WR5	2438	.044
	V8 5.8L		UR5	2771			UR5IX	7177	UR5GP	3547	UR5	2771	.044
	V8 7.5L		UR4	6630			UR4IX	7401	UR4GP	2869	UR4	6630	.044
1985	L6 4.9L	GAS	WR5	2438			WR5IX	7510			WR5	2438	.044
		LPG	WR5	2438			WR5IX	7510			WR5	2438	.034
	V8 5.8L	Vin G	UR4	6630			UR4IX	7401	UR4GP	2869	UR4	6630	.044
		Vin H	UR5	2771			UR5IX	7177	UR5GP	3547	UR5	2771	.044
	V8 7.5L		UR4	6630			UR4IX	7401	UR4GP	2869	UR4	6630	.044
<b>F-350 Super Duty</b>													
2017-11	V8 6.2L	Dual Plug; 16 Req'd	PLTR6A-10G	3587	LTR6BHX	90495	LTR6IX-11	6509	LTR6GP	90198			.044
2010-09	V8 5.4L		<b>PZNR6A11H</b>	<b>5507</b>			ZNAR6AIX-11	372	ZNAR6AGP	1698			.044
	V8 6.4L	DIESEL	<b>Y-408JS</b>	<b>5616</b>									
	V10 6.8L		<b>PZNR6A11H</b>	<b>5507</b>			ZNAR6AIX-11	372	ZNAR6AGP	1698			.044
2008	V8 5.4L	New Eng. Design w/Brown Coil Boots ONLY. NO NGK Part # for Old Eng. Design (w/Black Coil Boots)	<b>PZNR6A11H</b>	<b>5507</b>			ZNAR6AIX-11	372	ZNAR6AGP	1698			.044
	V8 6.4L	DIESEL	<b>Y-408JS</b>	<b>5616</b>									
	V10 6.8L	New Eng. Design w/Brown Coil Boots ONLY. NO NGK Part # for Old Eng. Design (w/Black Coil Boots)	<b>PZNR6A11H</b>	<b>5507</b>			ZNAR6AIX-11	372	ZNAR6AGP	1698			.044
2007-05	V8 6.0L	DIESEL	Y4002J	97190									
2004	V8 5.4L	GAS	PTR5C-13	7740	TR5AHX	94567	TR55IX	7164	TR55GP	3403	TR55	3951	.054



Year	Cyl. L	Notes	Original Equipment		Ruthenium HX		Iridium IX		G-Power		V-Power		Gap
			Part	Stock	Part	Stock	Part	Stock	Part	Stock	Part	Stock	
<b>FORD (Cont'd)</b>													
<b>F-350 Super Duty (Cont'd)</b>													
2004	V8 6.0L	DIESEL, From Engine Serial # 6155637	Y4002J	97190									
	V10 6.8L		PTR5C-13	7740	TR5AHX	94567	TR55IX	7164	TR55GP	3403	TR55	3951	.054
2003-99	V8 5.4L	GAS	PTR5C-13	7740	TR5AHX	94567	TR55IX	7164	TR55GP	3403	TR55	3951	.054
	V8 7.3L	DIESEL	Y1037J	97928									
	V10 6.8L		PTR5C-13	7740	TR5AHX	94567	TR55IX	7164	TR55GP	3403	TR55	3951	.054
<b>F-450 Super Duty</b>													
2018-11	V10 6.8L		<b>PZNAR6A11H</b>	<b>5507</b>			ZNAR6AIX-11	372	ZNAR6AGP	1698			.044
2010-09	V8 6.4L	DIESEL	<b>Y-408JS</b>	<b>5616</b>									
	V10 6.8L		<b>PZNAR6A11H</b>	<b>5507</b>			ZNAR6AIX-11	372	ZNAR6AGP	1698			.044
2008	V8 6.4L	DIESEL	<b>Y-408JS</b>	<b>5616</b>									
	V10 6.8L	New Eng. Design w/Brown Coil Boots ONLY. NO NGK Part # for Old Eng. Design (w/Black Coil Boots)	<b>PZNAR6A11H</b>	<b>5507</b>			ZNAR6AIX-11	372	ZNAR6AGP	1698			.044
2007-05	V8 6.0L	DIESEL	Y4002J	97190									
2004	V8 6.0L	DIESEL, From Engine Serial # 6155637	Y4002J	97190									
	V10 6.8L		PTR5C-13	7740	TR5AHX	94567	TR55IX	7164	TR55GP	3403	TR55	3951	.054
2003-99	V8 7.3L	DIESEL	Y1037J	97928									
	V10 6.8L		PTR5C-13	7740	TR5AHX	94567	TR55IX	7164	TR55GP	3403	TR55	3951	.054
<b>F-550 Super Duty</b>													
2018-11	V10 6.8L		<b>PZNAR6A11H</b>	<b>5507</b>			ZNAR6AIX-11	372	ZNAR6AGP	1698			.044
2010-09	V8 6.4L	DIESEL	<b>Y-408JS</b>	<b>5616</b>									
	V10 6.8L		<b>PZNAR6A11H</b>	<b>5507</b>			ZNAR6AIX-11	372	ZNAR6AGP	1698			.044
2008	V8 6.4L	DIESEL	<b>Y-408JS</b>	<b>5616</b>									
	V10 6.8L	New Eng. Design w/Brown Coil Boots ONLY. NO NGK Part # for Old Eng. Design (w/Black Coil Boots)	<b>PZNAR6A11H</b>	<b>5507</b>			ZNAR6AIX-11	372	ZNAR6AGP	1698			.044
2007-05	V8 6.0L	DIESEL	Y4002J	97190									
2004	V8 6.0L	DIESEL, From Engine Serial # 6155637	Y4002J	97190									
	V10 6.8L		PTR5C-13	7740	TR5AHX	94567	TR55IX	7164	TR55GP	3403	TR55	3951	.054
2003-99	V8 7.3L	DIESEL	Y1037J	97928									
	V10 6.8L		PTR5C-13	7740	TR5AHX	94567	TR55IX	7164	TR55GP	3403	TR55	3951	.054
<b>Festiva</b>													
1993-88	L4 1.3L		BPR6ES-11	7133			BPR6EIX-11	3903	BPR6EGP	7084	BPR6EY-11	6261	.044
<b>Fiesta</b>													
2017-14	L3 1.0L		<b>SILZNR8C7H</b>	<b>93593</b>									.028
	L4 1.6L	Naturally Aspirated	<b>ILTR6H8G</b>	<b>96870</b>	LTR6BHX	90495	LTR6IX	94374	LTR6GP-8	94372			.032
		Turbo	<b>ILZTR6A8G</b>	<b>94769</b>	LTR6BHX	90495							.032
2013-11	L4 1.6L		<b>ILTR6H8G</b>	<b>96870</b>	LTR6BHX	90495	LTR6IX	94374	LTR6GP-8	94372			.032
<b>Five Hundred</b>													
2007-05	V6 3.0L		PTR5C-13	7740	TR5AHX	94567	TR55IX	7164	TR55GP	3403	TR55	3951	.054
<b>Flex</b>													
2019-13	V6 3.5L	Naturally Aspirated	<b>LTR6BP13</b>	<b>94806</b>	LTR6AHX	91276	LTR6IX-11	6509					.052
		Turbo	<b>LTR6CI-8</b>	<b>97177</b>	LTR6BHX	90495	LTR6IX	94374	LTR6GP-8	94372			.032
2012	V6 3.5L	Naturally Aspirated, From 2/27/2012	<b>LTR6BP13</b>	<b>94806</b>	LTR6AHX	91276	LTR6IX-11	6509					.052
		Naturally Aspirated, To 2/27/2012	<b>ILTR5K13</b>	<b>90607</b>	LTR5AHX	90220	LTR5IX-11	4344	LTR5GP	5019			.052
		Turbo	<b>LTR6CI-8</b>	<b>97177</b>	LTR6BHX	90495	LTR6IX	94374	LTR6GP-8	94372			.032
2011-10	V6 3.5L	Naturally Aspirated	<b>ILTR5K13</b>	<b>90607</b>	LTR5AHX	90220	LTR5IX-11	4344	LTR5GP	5019			.052
		Turbo	<b>LTR6CI-8</b>	<b>97177</b>	LTR6BHX	90495	LTR6IX	94374	LTR6GP-8	94372			.032
2009	V6 3.5L		<b>ILTR5K13</b>	<b>90607</b>	LTR5AHX	90220	LTR5IX-11	4344	LTR5GP	5019			.052
<b>Focus</b>													
2017-16	L3 1.0L		<b>SILZNR8C7H</b>	<b>93593</b>									.028
	L4 2.0L	Naturally Aspirated	<b>LTR6BI-9</b>	<b>92182</b>	LTR6AHX	91276	LTR6IX	94374	LTR6GP-8	94372			.036
		Turbo	<b>LTR6DI-8</b>	<b>96588</b>	LTR6BHX	90495	LTR6IX	94374	LTR6GP-8	94372			.032

**Bold denotes NGK OE Manufacturer and/or OE Service Part**  
NOT BOLD denotes OE Equivalent Part

Note: Due to different operating or engine conditions, alternate heat range plugs may be required.

143

**Le texte en gras désigne une pièce d'équipement originale du manufacturier NGK et/ou pièce d'équipement originale de service**  
Le texte non en gras désigne une pièce d'équipement originale équivalente

Note: En raison de différences au niveau du fonctionnement ou des conditions du moteur, d'autres types de bougies avec variation de chaleur peuvent être nécessaires



Year	Cyl. L	Notes	Original Equipment		Ruthenium HX		Iridium IX		G-Power		V-Power		Gap
			Part	Stock	Part	Stock	Part	Stock	Part	Stock	Part	Stock	
<b>FORD (Cont'd)</b>													
<b>Focus (Cont'd)</b>													
2017-16	L4 2.3L		<b>ILTR6G8G</b>	<b>96621</b>	LTR6BHX	90495	LTR6IX	94374	LTR6GP-8	94372			.032
2015	L3 1.0L		<b>SILZNR8C7H</b>	<b>93593</b>									.028
	L4 2.0L	Naturally Aspirated	<b>LTR6BI-9</b>	<b>92182</b>	LTR6AHX	91276	LTR6IX	94374	LTR6GP-8	94372			.036
		Turbo	<b>LTR6DI-8</b>	<b>96588</b>	LTR6BHX	90495	LTR6IX	94374	LTR6GP-8	94372			.032
2014-13	L4 2.0L	Naturally Aspirated	<b>LTR6BI-9</b>	<b>92182</b>	LTR6AHX	91276	LTR6IX	94374	LTR6GP-8	94372			.036
		Turbo	<b>LTR6DI-8</b>	<b>96588</b>	LTR6BHX	90495	LTR6IX	94374	LTR6GP-8	94372			.032
2012	L4 2.0L	From 6/1/2011	<b>LTR6BI-9</b>	<b>92182</b>	LTR6AHX	91276	LTR6IX	94374	LTR6GP-8	94372			.036
		To 5/31/2011	<b>ILTR6F9</b>	<b>90656</b>	LTR6AHX	91276	LTR6IX	94374	LTR6GP-8	94372			.036
2011	L4 2.0L		<b>ITR5H13</b>	<b>97287</b>	TR5AHX	94567	TR55IX	7164	TR55GP	3403	TR55	3951	.052
2010-08	L4 2.0L		<b>TR6AP-13</b>	<b>5809</b>	TR6AHX	92714	TR65IX	3692	TR6GP	5141	TR6	4177	.052
2007-06	L4 2.0L		<b>TR6AP-13</b>	<b>5809</b>	TR6AHX	92714	TR65IX	3692	TR6GP	5141	TR6	4177	.052
	L4 2.3L		<b>ITR6F13</b>	<b>4477</b>	TR6AHX	92714	TR65IX	3692	TR6GP	5141	TR6	4177	.052
2005	L4 2.0L		<b>ITR6F13</b>	<b>4477</b>	TR6AHX	92714	TR65IX	3692	TR6GP	5141	TR6	4177	.052
	L4 2.3L		<b>ITR6F13</b>	<b>4477</b>	TR6AHX	92714	TR65IX	3692	TR6GP	5141	TR6	4177	.052
2004-03	L4 2.0L	DOHC	PTR5A-13	2467			LTR5IX-11	4344	LTR5GP	5019			.052
		SOHC	TR55-1GP	7159			TR55-1IX	7316	TR55-1GP	7159	TR55-1	2683	.054
	L4 2.3L		<b>ITR6F13</b>	<b>4477</b>	TR6AHX	92714	TR65IX	3692	TR6GP	5141	TR6	4177	.052
2002-00	L4 2.0L	DOHC	PTR5A-13	2467			LTR5IX-11	4344	LTR5GP	5019			.052
		SOHC	TR55-1GP	7159			TR55-1IX	7316	TR55-1GP	7159	TR55-1	2683	.054
<b>Freestar</b>													
2007-06	V6 3.9L		TR55-1	2683			TR55-1IX	7316	TR55-1GP	7159	TR55-1	2683	.054
	V6 4.2L		TR55-1	2683			TR55-1IX	7316	TR55-1GP	7159	TR55-1	2683	.054
2005-04	V6 3.9L		PTR5C-13	7740			TR55IX	7164	TR55GP	3403	TR55	3951	.054
	V6 4.2L		PTR5C-13	7740			TR55IX	7164	TR55GP	3403	TR55	3951	.054
<b>Freestyle</b>													
2007-05	V6 3.0L		PTR5C-13	7740	TR5AHX	94567	TR55IX	7164	TR55GP	3403	TR55	3951	.054
<b>F Super Duty</b>													
1997	V8 7.3L	DIESEL	Y1037J	97928									
	V8 7.5L		UR5	2771			UR5IX	7177	UR5GP	3547	UR5	2771	.044
1996-95	V8 7.3L	DIESEL	Y1037J	97928									
	V8 7.5L		UR4	6630			UR4IX	7401	UR4GP	2869	UR4	6630	.044
1994-93	V8 7.3L	DIESEL, Turbo	Y1037J	97928									
	V8 7.5L		UR4	6630			UR4IX	7401	UR4GP	2869	UR4	6630	.044
1992-90	V8 7.5L		UR4	6630			UR4IX	7401	UR4GP	2869	UR4	6630	.044
1988	V8 7.5L		UR4	6630			UR4IX	7401	UR4GP	2869	UR4	6630	.044
<b>Fusion</b>													
2018-17	L4 1.5L		<b>ILZNR8A7G</b>	<b>91924</b>									.028
	L4 2.0L	Naturally Aspirated	<b>ILTR5K13</b>	<b>90607</b>	LTR5AHX	90220	LTR5IX-11	4344	LTR5GP	5019			.052
		Turbo	<b>ILTR6G8G</b>	<b>96621</b>	LTR6BHX	90495	LTR6IX	94374	LTR6GP-8	94372			.032
	L4 2.5L		<b>ILTR5K13</b>	<b>90607</b>	LTR5AHX	90220	LTR5IX-11	4344	LTR5GP	5019			.052
	V6 2.7L		<b>ILTR7N8</b>	<b>95822</b>	LTR7BHX	95605							.032
2016-15	L4 1.5L		<b>ILZNR8A7G</b>	<b>91924</b>									.028
	L4 2.0L	Naturally Aspirated	<b>ILTR5K13</b>	<b>90607</b>	LTR5AHX	90220	LTR5IX-11	4344	LTR5GP	5019			.052
		Turbo	<b>LTR6DI-8</b>	<b>96588</b>	LTR6BHX	90495	LTR6IX	94374	LTR6GP-8	94372			.032
L4 2.5L		<b>ILTR5K13</b>	<b>90607</b>	LTR5AHX	90220	LTR5IX-11	4344	LTR5GP	5019			.052	
2014	L4 1.5L		<b>ILZNR8A7G</b>	<b>91924</b>									.028
	L4 1.6L		<b>ILZTR6A8G</b>	<b>94769</b>	LTR6BHX	90495							.032
	L4 2.0L	Naturally Aspirated	<b>ILTR5K13</b>	<b>90607</b>	LTR5AHX	90220	LTR5IX-11	4344	LTR5GP	5019			.052
		Turbo	<b>LTR6DI-8</b>	<b>96588</b>	LTR6BHX	90495	LTR6IX	94374	LTR6GP-8	94372			.032
	L4 2.5L		<b>ILTR5K13</b>	<b>90607</b>	LTR5AHX	90220	LTR5IX-11	4344	LTR5GP	5019			.052
2013	L4 1.6L		<b>ILZTR6A8G</b>	<b>94769</b>	LTR6BHX	90495							.032
	L4 2.0L	Naturally Aspirated	<b>ILTR5K13</b>	<b>90607</b>	LTR5AHX	90220	LTR5IX-11	4344	LTR5GP	5019			.052
		Turbo	<b>LTR6DI-8</b>	<b>96588</b>	LTR6BHX	90495	LTR6IX	94374	LTR6GP-8	94372			.032
L4 2.5L		<b>ILTR5K13</b>	<b>90607</b>	LTR5AHX	90220	LTR5IX-11	4344	LTR5GP	5019			.052	
2012-11	L4 2.5L		<b>ILTR5K13</b>	<b>90607</b>	LTR5AHX	90220	LTR5IX-11	4344	LTR5GP	5019			.052
	V6 3.0L		<b>TR5C-12</b>	<b>92838</b>	TR5AHX	94567	TR5IX	7397	TR5GP	3186	TR5	2238	.048
	V6 3.5L		<b>ILTR5K13</b>	<b>90607</b>	LTR5AHX	90220	LTR5IX-11	4344	LTR5GP	5019			.052



Year	Cyl. L	Notes	Original Equipment		Ruthenium HX		Iridium IX		G-Power		V-Power		Gap
			Part	Stock	Part	Stock	Part	Stock	Part	Stock	Part	Stock	
<b>FORD (Cont'd)</b>													
<b>Fusion (Cont'd)</b>													
2010	L4 2.5L		<b>ILTR5K13</b>	<b>90607</b>	LTR5AHX	90220	LTR5IX-11	4344	LTR5GP	5019			.052
	V6 3.0L	From 8/3/2009	<b>TR5C-12</b>	<b>92838</b>	TR5AHX	94567	TR5IX	7397	TR5GP	3186	TR5	2238	.048
		To 8/3/2009	<b>TR5C-12</b>	<b>92838</b>	TR5AHX	94567	TR5IX	7397	TR5GP	3186	TR5	2238	.048
	V6 3.5L		<b>ILTR5K13</b>	<b>90607</b>	LTR5AHX	90220	LTR5IX-11	4344	LTR5GP	5019			.052
2009-06	L4 2.3L		<b>ILTR5K13</b>	<b>90607</b>	LTR5AHX	90220	LTR5IX-11	4344	LTR5GP	5019			.052
	V6 3.0L		PTR5C-13	7740	TR5AHX	94567	TR55IX	7164	TR55GP	3403	TR55	3951	.054
<b>GT</b>													
2006-05	V8 5.4L		PTR6D-13	5598			TR6IX	3689	TR6GP	5141	TR6	4177	.044
<b>LTD</b>													
1986	L4 2.3L		TR5-1	7060			TR5-1IX	7243	TR5-1GP	3716	TR5-1	7060	.044
	V6 3.8L		TR55-1	2683			TR55-1IX	7316	TR55-1GP	7159	TR55-1	2683	.054
	V8 5.0L		TR55-1	2683			TR55-1IX	7316	TR55-1GP	7159	TR55-1	2683	.050
	V8 5.8L		UR4	6630			UR4IX	7401	UR4GP	2869	UR4	6630	.044
1985	L4 2.3L	GAS	TR5-1	7060			TR5-1IX	7243	TR5-1GP	3716	TR5-1	7060	.044
		LPG	TR5	2238			TR5IX	7397	TR5GP	3186	TR5	2238	.034
	V6 3.8L		TR55-1	2683			TR55-1IX	7316	TR55-1GP	7159	TR55-1	2683	.054
	V8 5.0L	CARB	UR4	6630			UR4IX	7401	UR4GP	2869	UR4	6630	.044
		FI	UR45	6945			UR45IX	7559	UR45GP	3207	UR45	6945	.050
	V8 5.8L		UR4	6630			UR4IX	7401	UR4GP	2869	UR4	6630	.044
<b>LTD Crown Victoria</b>													
1991-87	V8 5.0L		TR55-1	2683			TR55-1IX	7316	TR55-1GP	7159	TR55-1	2683	.050
	V8 5.8L		UR4	6630			UR4IX	7401	UR4GP	2869	UR4	6630	.044
<b>Mustang</b>													
2018	V8 5.0L		<b>LTR6DP13</b>	<b>90374</b>	LTR7BHX	95605							.052
2017-15	L4 2.3L		<b>LTR6DI-8</b>	<b>96588</b>	LTR6BHX	90495	LTR6IX	94374	LTR6GP-8	94372			.032
	V6 3.7L		<b>LTR6BP13</b>	<b>94806</b>	LTR6AHX	91276	LTR6IX-11	6509					.052
	V8 5.0L		<b>LTR6DP13</b>	<b>90374</b>	LTR6AHX	91276	LTR6IX-11	6509					.052
	V8 5.2L		<b>LTR6DP13</b>	<b>90374</b>	LTR6AHX	91276	LTR6IX-11	6509					.052
2014-13	V6 3.7L		<b>LTR6BP13</b>	<b>94806</b>	LTR6AHX	91276	LTR6IX-11	6509					.052
	V8 5.0L		<b>LTR6AI13</b>	<b>95853</b>	LTR6AHX	91276	LTR6IX-11	6509					.052
	V8 5.8L		<b>ITR6G9</b>	<b>90156</b>			TR6IX	3689	TR6GP	5141	TR6	4177	.036
2012-11	V6 3.7L		<b>LTR6BP13</b>	<b>94806</b>	LTR6AHX	91276	LTR6IX-11	6509					.052
	V8 5.0L		<b>LTR6AI13</b>	<b>95853</b>	LTR6AHX	91276	LTR6IX-11	6509					.052
	V8 5.4L		PTR6D-13	5598			TR6IX	3689	TR6GP	5141	TR6	4177	.044
2010-09	V6 4.0L		TR55-1	2683			TR55-1IX	7316	TR55-1GP	7159	TR55-1	2683	.054
	V8 4.6L		<b>PZNAR6A11H</b>	<b>5507</b>			ZNAR6AIX-11	372	ZNAR6AGP	1698			.044
	V8 5.4L		PTR6D-13	5598			TR6IX	3689	TR6GP	5141	TR6	4177	.044
2008	V6 4.0L		TR55-1	2683			TR55-1IX	7316	TR55-1GP	7159	TR55-1	2683	.054
	V8 4.6L	New engine style with brown coil boots only (NGK N/A for old engine design with black coil boots)	<b>PZNAR6A11H</b>	<b>5507</b>			ZNAR6AIX-11	372	ZNAR6AGP	1698			.044
	V8 5.4L		PTR6D-13	5598			TR6IX	3689	TR6GP	5141	TR6	4177	.044
2007	V6 4.0L		TR55-1	2683			TR55-1IX	7316	TR55-1GP	7159	TR55-1	2683	.054
	V8 5.4L		PTR6D-13	5598			TR6IX	3689	TR6GP	5141	TR6	4177	.044
2006-05	V6 4.0L		TR55-1	2683			TR55-1IX	7316	TR55-1GP	7159	TR55-1	2683	.054
2004	V6 3.8L		PTR5C-13	7740			TR55IX	7164	TR55GP	3403	TR55	3951	.054
	V6 3.9L		PTR5C-13	7740			TR55IX	7164	TR55GP	3403	TR55	3951	.054
	V8 4.6L	Naturally Aspirated	PTR5C-13	7740	TR5AHX	94567	TR55IX	7164	TR55GP	3403	TR55	3951	.052
		Supercharged	PTR6D-13	5598			TR65IX	3692	TR6GP	5141	TR6	4177	.054
2003	V6 3.8L		PTR5C-13	7740			TR55IX	7164	TR55GP	3403	TR55	3951	.054
	V8 4.6L	Naturally Aspirated	PTR5C-13	7740	TR5AHX	94567	TR55IX	7164	TR55GP	3403	TR55	3951	.052
Supercharged		PTR6D-13	5598			TR65IX	3692	TR6GP	5141	TR6	4177	.054	
2002-01	V6 3.8L		PTR5C-13	7740			TR55IX	7164	TR55GP	3403	TR55	3951	.054
	V8 4.6L		PTR5C-13	7740	TR5AHX	94567	TR55IX	7164	TR55GP	3403	TR55	3951	.054
2000	V6 3.8L		PTR5C-13	7740			TR55IX	7164	TR55GP	3403	TR55	3951	.054
	V8 4.6L		PTR5C-13	7740	TR5AHX	94567	TR55IX	7164	TR55GP	3403	TR55	3951	.054

**Bold denotes NGK OE Manufacturer and/or OE Service Part**  
NOT BOLD denotes OE Equivalent Part

**Le texte en gras désigne une pièce d'équipement originale du manufacturier NGK et/ou pièce d'équipement originale de service**  
Le texte non en gras désigne une pièce d'équipement originale équivalente

Note: Due to different operating or engine conditions, alternate heat range plugs may be required.

Note: En raison de différences au niveau du fonctionnement ou des conditions du moteur, d'autres types de bougies avec variation de chaleur peuvent être nécessaires





Year	Cyl. L	Notes	Original Equipment		Ruthenium HX		Iridium IX		G-Power		V-Power		Gap
			Part	Stock	Part	Stock	Part	Stock	Part	Stock	Part	Stock	
<b>FORD (Cont'd)</b>													
<b>Mustang (Cont'd)</b>													
2000	V8 5.4L		PTR5F-11	6579	TR5AHX	94567	TR5IX	7397	TR5GP	3186	TR5	2238	.044
1999	V6 3.8L		PTR5C-13	7740			TR55IX	7164	TR55GP	3403	TR55	3951	.054
	V8 4.6L		PTR5C-13	7740	TR5AHX	94567	TR55IX	7164	TR55GP	3403	TR55	3951	.054
1998	V6 3.8L		PTR5C-13	7740			TR55IX	7164	TR55GP	3403	TR55	3951	.054
	V8 4.6L		PTR5C-13	7740			TR55IX	7164	TR55GP	3403	TR55	3951	.054
1997-96	V6 3.8L		TR55-1	2683			TR55-1IX	7316	TR55-1GP	7159	TR55-1	2683	.054
	V8 4.6L		PTR5C-13	7740			TR55IX	7164	TR55GP	3403	TR55	3951	.054
1995	V6 3.8L		TR55-1	2683			TR55-1IX	7316	TR55-1GP	7159	TR55-1	2683	.054
	V8 5.0L	Vin D	TR55	3951			TR55IX	7164	TR55GP	3403	TR55	3951	.054
		Vin T	UR45	6945			UR45IX	7559	UR45GP	3207	UR45	6945	.054
V8 5.8L		UR6	7773			UR6IX	7348	UR6GP	7966	UR6	7773	.050	
1994	V6 3.8L		TR55-1	2683			TR55-1IX	7316	TR55-1GP	7159	TR55-1	2683	.054
	V8 5.0L	Vin D	PTR5C-13	7740			TR55IX	7164	TR55GP	3403	TR55	3951	.054
		Vin T	UR45	6945			UR45IX	7559	UR45GP	3207	UR45	6945	.054
1993	L4 2.3L	Dual Plug; 8 Req'd	TR5	2238			TR5IX	7397	TR5GP	3186	TR5	2238	.044
	V8 5.0L	Vin D	PTR5C-13	7740			TR55IX	7164	TR55GP	3403	TR55	3951	.054
		Vin E	UR45	6945			UR45IX	7559	UR45GP	3207	UR45	6945	.054
1992-91	L4 2.3L	Dual Plug; 8 Req'd	TR5	2238			TR5IX	7397	TR5GP	3186	TR5	2238	.044
	V8 5.0L		UR45	6945			UR45IX	7559	UR45GP	3207	UR45	6945	.054
1990-87	L4 2.3L		TR5-1	7060			TR5-1IX	7243	TR5-1GP	3716	TR5-1	7060	.044
	V8 5.0L		UR45	6945			UR45IX	7559	UR45GP	3207	UR45	6945	.054
1986	L4 2.3L	Naturally Aspirated	TR5-1	7060			TR5-1IX	7243	TR5-1GP	3716	TR5-1	7060	.044
		Turbo	TR5	2238			TR5IX	7397	TR5GP	3186	TR5	2238	.034
	V6 3.8L		TR55-1	2683			TR55-1IX	7316	TR55-1GP	7159	TR55-1	2683	.054
	V8 5.0L		TR55-1	2683			TR55-1IX	7316	TR55-1GP	7159	TR55-1	2683	.050
1985	L4 2.3L	Naturally Aspirated	TR5-1	7060			TR5-1IX	7243	TR5-1GP	3716	TR5-1	7060	.044
		Turbo	TR5	2238			TR5IX	7397	TR5GP	3186	TR5	2238	.034
	V6 3.8L		TR55-1	2683			TR55-1IX	7316	TR55-1GP	7159	TR55-1	2683	.054
	V8 5.0L	CARB	UR4	6630			UR4IX	7401	UR4GP	2869	UR4	6630	.044
FI		UR45	6945			UR45IX	7559	UR45GP	3207	UR45	6945	.050	
<b>Police Interceptor Sedan</b>													
2017-13	V6 3.5L	Naturally Aspirated	<b>LTR6BP13</b>	<b>94806</b>	LTR6AHX	91276	LTR6IX-11	6509					.052
		Turbo	<b>LTR6CI-8</b>	<b>97177</b>	LTR6BHX	90495	LTR6IX	94374	LTR6GP-8	94372			.032
	V6 3.7L	<b>LTR6BP13</b>	<b>94806</b>	LTR6AHX	91276	LTR6IX-11	6509					.052	
<b>Police Interceptor Utility</b>													
2017-14	V6 3.5L	Turbo	<b>LTR6CI-8</b>	<b>97177</b>	LTR6BHX	90495	LTR6IX	94374	LTR6GP-8	94372			.032
	V6 3.7L		<b>LTR6BP13</b>	<b>94806</b>	LTR6AHX	91276	LTR6IX-11	6509					.052
2013	V6 3.7L		<b>LTR6BP13</b>	<b>94806</b>	LTR6AHX	91276	LTR6IX-11	6509					.052
<b>Probe</b>													
1997	L4 2.0L		<b>BKR6E-11</b>	<b>2756</b>	FR6AHX-S	94279	BKR6EIX-11	3764	BKR6EGP	7092	BKR6E-11	2756	.044
	V6 2.5L		<b>ZFR6F-11</b>	<b>4291</b>	FR6AHX-S	94279	ZFR6FIX-11	6441	ZFR6FGP	7100	ZFR6F-11	4291	.044
1996-95	L4 2.0L		<b>BKR6E-11</b>	<b>2756</b>			BKR6EIX-11	3764	BKR6EGP	7092	BKR6E-11	2756	.044
	V6 2.5L		<b>ZFR6F-11</b>	<b>4291</b>			ZFR6FIX-11	6441	ZFR6FGP	7100	ZFR6F-11	4291	.044
1994-93	L4 2.0L		<b>BKR6E-11</b>	<b>2756</b>			BKR6EIX-11	3764	BKR6EGP	7092	BKR6E-11	2756	.044
	V6 2.5L		ZFR6F-11	4291			ZFR6FIX-11	6441	ZFR6FGP	7100	ZFR6F-11	4291	.044
1992-90	L4 2.2L		ZFR6F-11	4291			ZFR6FIX-11	6441	ZFR6FGP	7100	ZFR6F-11	4291	.044
	V6 3.0L		PTR5F-11	6579			TR5IX	7397	TR5GP	3186	TR5	2238	.044
1989	L4 2.2L		ZFR6F-11	4291			ZFR6FIX-11	6441	ZFR6FGP	7100	ZFR6F-11	4291	.044
<b>Ranger</b>													
2011-10	L4 2.3L		<b>ITR5H13</b>	<b>97287</b>			TR55IX	7164	TR55GP	3403	TR55	3951	.044
	V6 4.0L		TR55-1	2683			TR55-1IX	7316	TR55-1GP	7159	TR55-1	2683	.054
2009	L4 2.3L		<b>PTR5F-11</b>	<b>6579</b>			TR5IX	7397	TR5GP	3186	TR5	2238	.044
	V6 4.0L		TR55-1	2683			TR55-1IX	7316	TR55-1GP	7159	TR55-1	2683	.054
2008	L4 2.3L		<b>PTR5F-11</b>	<b>6579</b>			TR5IX	7397	TR5GP	3186	TR5	2238	.044
	V6 3.0L		PTR5C-13	7740			TR55IX	7164	TR55GP	3403	TR55	3951	.054
	V6 4.0L		TR55-1	2683			TR55-1IX	7316	TR55-1GP	7159	TR55-1	2683	.054
2007-03	L4 2.3L		<b>PTR5F-11</b>	<b>6579</b>			TR5IX	7397	TR5GP	3186	TR5	2238	.044



Year	Cyl. L	Notes	Original Equipment		Ruthenium HX		Iridium IX		G-Power		V-Power		Gap
			Part	Stock	Part	Stock	Part	Stock	Part	Stock	Part	Stock	
<b>FORD (Cont'd)</b>													
<b>Ranger (Cont'd)</b>													
2007-03	V6 3.0L		PTR5F-11	6579			TR5IX	7397	TR5GP	3186	TR5	2238	.044
	V6 4.0L		TR55-1	2683			TR55-1IX	7316	TR55-1GP	7159	TR55-1	2683	.054
2002	L4 2.3L		<b>PTR5F-11</b>	<b>6579</b>			TR5IX	7397	TR5GP	3186	TR5	2238	.044
	V6 3.0L		PTR5F-11	6579			TR5IX	7397	TR5GP	3186	TR5	2238	.044
	V6 4.0L	Vin E	TR55-1	2683			TR55-1IX	7316	TR55-1GP	7159	TR55-1	2683	.054
2001	L4 2.3L		<b>PTR5F-11</b>	<b>6579</b>			TR5IX	7397	TR5GP	3186	TR5	2238	.044
	L4 2.5L	Dual Plug; 8 Req'd	PTR5F-11	6579			TR5IX	7397	TR5GP	3186	TR5	2238	.044
	V6 3.0L		PTR5F-11	6579			TR5IX	7397	TR5GP	3186	TR5	2238	.044
	V6 4.0L	Vin E	TR55-1	2683			TR55-1IX	7316	TR55-1GP	7159	TR55-1	2683	.054
2000-99	L4 2.5L	Dual Plug; 8 Req'd	PTR5F-11	6579			TR5IX	7397	TR5GP	3186	TR5	2238	.044
	V6 3.0L	FLEX	PTR5F-11	6579			TR5IX	7397	TR5GP	3186	TR5	2238	.044
		GAS	PTR5F-11	6579			TR5IX	7397	TR5GP	3186	TR5	2238	.044
V6 4.0L		PTR6D-13	5598			TR65IX	3692	TR6GP	5141	TR6	4177	.054	
1998	L4 2.5L	Dual Plug; 8 Req'd	PTR5F-11	6579			TR5IX	7397	TR5GP	3186	TR5	2238	.044
	V6 3.0L		PTR5F-11	6579			TR5IX	7397	TR5GP	3186	TR5	2238	.044
	V6 4.0L		PTR6D-13	5598			TR65IX	3692	TR6GP	5141	TR6	4177	.054
1997	L4 2.3L	Dual Plug; 8 Req'd	PTR5F-11	6579			TR5IX	7397	TR5GP	3186	TR5	2238	.044
	V6 3.0L		PTR5F-11	6579			TR5IX	7397	TR5GP	3186	TR5	2238	.044
	V6 4.0L		PTR6D-13	5598			TR65IX	3692	TR6GP	5141	TR6	4177	.054
1996-94	L4 2.3L	Dual Plug; 8 Req'd	PTR5F-11	6579			TR5IX	7397	TR5GP	3186	TR5	2238	.044
	V6 3.0L		PTR5F-11	6579			TR5IX	7397	TR5GP	3186	TR5	2238	.044
	V6 4.0L		PTR5C-13	7740			TR55IX	7164	TR55GP	3403	TR55	3951	.054
1993	L4 2.3L	Dual Plug; 8 Req'd	TR5	2238			TR5IX	7397	TR5GP	3186	TR5	2238	.044
	V6 3.0L		PTR5F-11	6579			TR5IX	7397	TR5GP	3186	TR5	2238	.044
	V6 4.0L		PTR5C-13	7740			TR55IX	7164	TR55GP	3403	TR55	3951	.054
1992-91	L4 2.3L	Dual Plug; 8 Req'd	TR5	2238			TR5IX	7397	TR5GP	3186	TR5	2238	.044
	V6 2.9L		TR5	2238			TR5IX	7397	TR5GP	3186	TR5	2238	.044
	V6 3.0L		PTR5F-11	6579			TR5IX	7397	TR5GP	3186	TR5	2238	.044
	V6 4.0L		PTR5C-13	7740			TR55IX	7164	TR55GP	3403	TR55	3951	.054
1990	L4 2.3L	Dual Plug; 8 Req'd	TR5	2238			TR5IX	7397	TR5GP	3186	TR5	2238	.044
	V6 2.9L		TR5	2238			TR5IX	7397	TR5GP	3186	TR5	2238	.044
	V6 4.0L		PTR5C-13	7740			TR55IX	7164	TR55GP	3403	TR55	3951	.054
1989	L4 2.3L	Dual Plug; 8 Req'd	TR5	2238			TR5IX	7397	TR5GP	3186	TR5	2238	.044
	V6 2.9L		TR5	2238			TR5IX	7397	TR5GP	3186	TR5	2238	.044
1988	L4 2.0L		TR5	2238			TR5IX	7397	TR5GP	3186	TR5	2238	.044
	L4 2.3L		TR5-1	7060			TR5-1IX	7243	TR5-1GP	3716	TR5-1	7060	.044
	V6 2.9L		TR5	2238			TR5IX	7397	TR5GP	3186	TR5	2238	.044
1987-86	L4 2.0L		TR5	2238			TR5IX	7397	TR5GP	3186	TR5	2238	.044
	L4 2.3L	GAS	TR5-1	7060			TR5-1IX	7243	TR5-1GP	3716	TR5-1	7060	.044
	V6 2.9L		TR5	2238			TR5IX	7397	TR5GP	3186	TR5	2238	.044
1985	L4 2.0L		TR5	2238			TR5IX	7397	TR5GP	3186	TR5	2238	.044
	L4 2.3L	GAS	TR5-1	7060			TR5-1IX	7243	TR5-1GP	3716	TR5-1	7060	.044
	V6 2.8L		TR5	2238			TR5IX	7397	TR5GP	3186	TR5	2238	.044
<b>Special Service Police Sedan</b>													
2017-14	L4 2.0L		<b>LTR6DI-8</b>	<b>96588</b>	LTR6BHX	90495	LTR6IX	94374	LTR6GP-8	94372			.032
<b>Taurus</b>													
2017-14	L4 2.0L		<b>LTR6DI-8</b>	<b>96588</b>	LTR6BHX	90495	LTR6IX	94374	LTR6GP-8	94372			.032
	V6 3.5L	Naturally Aspirated	<b>LTR6BP13</b>	<b>94806</b>	LTR6AHX	91276	LTR6IX-11	6509					.052
		Turbo	<b>LTR6CI-8</b>	<b>97177</b>	LTR6BHX	90495	LTR6IX	94374	LTR6GP-8	94372			.032
2013	L4 2.0L		<b>ILTR6G8G</b>	<b>96621</b>	LTR6BHX	90495	LTR6IX	94374	LTR6GP-8	94372			.032
	V6 3.5L	Naturally Aspirated	<b>LTR6BP13</b>	<b>94806</b>	LTR6AHX	91276	LTR6IX-11	6509					.052
		Turbo	<b>LTR6CI-8</b>	<b>97177</b>	LTR6BHX	90495	LTR6IX	94374	LTR6GP-8	94372			.032
2012-10	V6 3.5L	Naturally Aspirated	<b>ILTR5K13</b>	<b>90607</b>	LTR5AHX	90220	LTR5IX-11	4344	LTR5GP	5019			.052
		Turbo	<b>LTR6CI-8</b>	<b>97177</b>	LTR6BHX	90495	LTR6IX	94374	LTR6GP-8	94372			.032
2009-08	V6 3.5L		<b>ILTR5K13</b>	<b>90607</b>	LTR5AHX	90220	LTR5IX-11	4344	LTR5GP	5019			.052
2007	V6 3.0L	GAS	PTR5F-11	6579			TR5IX	7397	TR5GP	3186	TR5	2238	.044
2006	V6 3.0L	FLEX	PTR6D-13	5598			TR6IX	3689	TR6GP	5141	TR6	4177	.044

**Bold denotes NGK OE Manufacturer and/or OE Service Part**  
NOT BOLD denotes OE Equivalent Part

**Le texte en gras désigne une pièce d'équipement originale du manufacturier NGK et/ou pièce d'équipement originale de service**  
Le texte non en gras désigne une pièce d'équipement originale équivalente

Note: Due to different operating or engine conditions, alternate heat range plugs may be required.

Note: En raison de différences au niveau du fonctionnement ou des conditions du moteur, d'autres types de bougies avec variation de chaleur peuvent être nécessaires



Year	Cyl. L	Notes	Original Equipment		Ruthenium HX		Iridium IX		G-Power		V-Power		Gap
			Part	Stock	Part	Stock	Part	Stock	Part	Stock	Part	Stock	
<b>FORD (Cont'd)</b>													
<b>Taurus (Cont'd)</b>													
2006		GAS	PTR5F-11	6579			TR5IX	7397	TR5GP	3186	TR5	2238	.044
2005-00	V6 3.0L	DOHC	PTR5C-13	7740	TR5AHX	94567	TR55IX	7164	TR55GP	3403	TR55	3951	.054
		FLEX, OHV	PTR6D-13	5598			TR6IX	3689	TR6GP	5141	TR6	4177	.044
		GAS, OHV	PTR5F-11	6579			TR5IX	7397	TR5GP	3186	TR5	2238	.044
1999	V6 3.0L	DOHC	PTR5C-13	7740			TR55IX	7164	TR55GP	3403	TR55	3951	.054
		FLEX, OHV	PTR6D-13	5598			TR6IX	3689	TR6GP	5141	TR6	4177	.044
		GAS, OHV	PTR5F-11	6579			TR5IX	7397	TR5GP	3186	TR5	2238	.044
	V8 3.4L		PTR5F-11	6579	TR5AHX	94567	TR5IX	7397	TR5GP	3186	TR5	2238	.044
1998-97	V6 3.0L	DOHC	PTR5C-13	7740			TR55IX	7164	TR55GP	3403	TR55	3951	.054
		OHV	PTR5F-11	6579			TR5IX	7397	TR5GP	3186	TR5	2238	.044
			PTR5F-11	6579	TR5AHX	94567	TR5IX	7397	TR5GP	3186	TR5	2238	.044
1996	V6 3.0L	DOHC	PTR5C-13	7740			TR55IX	7164	TR55GP	3403	TR55	3951	.054
		OHV	PTR5F-11	6579			TR5IX	7397	TR5GP	3186	TR5	2238	.044
			PTR5F-11	6579			TR5IX	7397	TR5GP	3186	TR5	2238	.044
1995-94	V6 3.0L	DOHC	<b>PFR5G-11</b>	<b>2647</b>			BKR5EIX-11	5464	BKR5EGP	7090	BKR5EYA-11	2526	.044
		GAS, OHV	PTR5F-11	6579			TR5IX	7397	TR5GP	3186	TR5	2238	.044
	V6 3.2L		<b>PFR5G-11</b>	<b>2647</b>			BKR5EIX-11	5464	BKR5EGP	7090	BKR5EYA-11	2526	.044
	V6 3.8L		TR55-1	2683			TR55-1IX	7316	TR55-1GP	7159	TR55-1	2683	.054
1993	V6 3.0L	DOHC	<b>PFR5G-11</b>	<b>2647</b>			BKR5EIX-11	5464	BKR5EGP	7090	BKR5EYA-11	2526	.044
		GAS, OHV	TR5	2238			TR5IX	7397	TR5GP	3186	TR5	2238	.044
	V6 3.2L		<b>PFR5G-11</b>	<b>2647</b>			BKR5EIX-11	5464	BKR5EGP	7090	BKR5EYA-11	2526	.044
	V6 3.8L		TR55-1	2683			TR55-1IX	7316	TR55-1GP	7159	TR55-1	2683	.054
1992	V6 3.0L	DOHC	<b>PFR5G-11</b>	<b>2647</b>			BKR5EIX-11	5464	BKR5EGP	7090	BKR5EYA-11	2526	.044
		OHV	TR5	2238			TR5IX	7397	TR5GP	3186	TR5	2238	.044
		V6 3.8L		TR55-1	2683			TR55-1IX	7316	TR55-1GP	7159	TR55-1	2683
1991-89	L4 2.5L		TR5	2238			TR5IX	7397	TR5GP	3186	TR5	2238	.044
	V6 3.0L	DOHC	<b>PFR5G-11</b>	<b>2647</b>			BKR5EIX-11	5464	BKR5EGP	7090	BKR5EYA-11	2526	.044
		OHV	TR5	2238			TR5IX	7397	TR5GP	3186	TR5	2238	.044
	V6 3.8L		TR55-1	2683			TR55-1IX	7316	TR55-1GP	7159	TR55-1	2683	.054
1988	L4 2.5L		TR5	2238			TR5IX	7397	TR5GP	3186	TR5	2238	.044
	V6 3.0L		TR5	2238			TR5IX	7397	TR5GP	3186	TR5	2238	.044
	V6 3.8L		TR55-1	2683			TR55-1IX	7316	TR55-1GP	7159	TR55-1	2683	.054
1987-86	L4 2.5L		TR5	2238			TR5IX	7397	TR5GP	3186	TR5	2238	.044
	V6 3.0L		TR5	2238			TR5IX	7397	TR5GP	3186	TR5	2238	.044
<b>Taurus X</b>													
2009-08	V6 3.5L		<b>ILTR5K13</b>	<b>90607</b>	LTR5AHX	90220	LTR5IX-11	4344	LTR5GP	5019			.052
<b>Tempo</b>													
1994-92	L4 2.3L		TR55	3951			TR55IX	7164	TR55GP	3403	TR55	3951	.054
	V6 3.0L		TR5	2238			TR5IX	7397	TR5GP	3186	TR5	2238	.044
1991-90	L4 2.3L		TR55	3951			TR55IX	7164	TR55GP	3403	TR55	3951	.054
1989	L4 2.3L	Vin S	TR5	2238			TR5IX	7397	TR5GP	3186	TR5	2238	.044
		Vin X	TR55	3951			TR55IX	7164	TR55GP	3403	TR55	3951	.054
1988-87	L4 2.3L		TR5	2238			TR5IX	7397	TR5GP	3186	TR5	2238	.044
1986-85	L4 2.0L	DIESEL	Y-107R	1229									
	L4 2.3L		TR5	2238			TR5IX	7397	TR5GP	3186	TR5	2238	.044
<b>Thunderbird</b>													
2005-02	V8 3.9L		FR5AP-11E	6569	FR5AHX-E	92375	BKR5EIX-11	5464	BKR5EGP	7090	BKR5E-11	6953	.044
1997-95	V6 3.8L		TR55-1	2683			TR55-1IX	7316	TR55-1GP	7159	TR55-1	2683	.054
	V8 4.6L		PTR5C-13	7740			TR55IX	7164	TR55GP	3403	TR55	3951	.054
1994	V6 3.8L		TR55-1	2683			TR55-1IX	7316	TR55-1GP	7159	TR55-1	2683	.054
	V8 4.6L		TR55	3951			TR55IX	7164	TR55GP	3403	TR55	3951	.054
1993-91	V6 3.8L		TR55-1	2683			TR55-1IX	7316	TR55-1GP	7159	TR55-1	2683	.054
	V8 5.0L		UR45	6945			UR45IX	7559	UR45GP	3207	UR45	6945	.054
1990-89	V6 3.8L		TR55-1	2683			TR55-1IX	7316	TR55-1GP	7159	TR55-1	2683	.054
1988-86	L4 2.3L		TR5	2238			TR5IX	7397	TR5GP	3186	TR5	2238	.034
	V6 3.8L		TR55-1	2683			TR55-1IX	7316	TR55-1GP	7159	TR55-1	2683	.054
	V8 5.0L		TR55-1	2683			TR55-1IX	7316	TR55-1GP	7159	TR55-1	2683	.050



Year	Cyl. L	Notes	Original Equipment		Ruthenium HX		Iridium IX		G-Power		V-Power		Gap
			Part	Stock	Part	Stock	Part	Stock	Part	Stock	Part	Stock	
<b>FORD (Cont'd)</b>													
<b>Thunderbird (Cont'd)</b>													
1985	L4 2.3L		TR5	2238			TR5IX	7397	TR5GP	3186	TR5	2238	.034
	V6 3.8L		TR55-1	2683			TR55-1IX	7316	TR55-1GP	7159	TR55-1	2683	.054
	V8 5.0L		UR45	6945			UR45IX	7559	UR45GP	3207	UR45	6945	.050
<b>Transit-150</b>													
2017-15	V6 3.5L		<b>LTR6CI-8</b>	<b>97177</b>	LTR6BHX	90495	LTR6IX	94374	LTR6GP-8	94372			.032
	V6 3.7L		<b>LTR6BP13</b>	<b>94806</b>	LTR6AHX	91276	LTR6IX-11	6509					.052
<b>Transit-250</b>													
2017-15	V6 3.5L		<b>LTR6CI-8</b>	<b>97177</b>	LTR6BHX	90495	LTR6IX	94374	LTR6GP-8	94372			.032
	V6 3.7L		<b>LTR6BP13</b>	<b>94806</b>	LTR6AHX	91276	LTR6IX-11	6509					.052
<b>Transit-350</b>													
2017-15	V6 3.5L		<b>LTR6CI-8</b>	<b>97177</b>	LTR6BHX	90495	LTR6IX	94374	LTR6GP-8	94372			.032
	V6 3.7L		<b>LTR6BP13</b>	<b>94806</b>	LTR6AHX	91276	LTR6IX-11	6509					.052
<b>Transit-350 HD</b>													
2017-15	V6 3.5L		<b>LTR6CI-8</b>	<b>97177</b>	LTR6BHX	90495	LTR6IX	94374	LTR6GP-8	94372			.032
	V6 3.7L		<b>LTR6BP13</b>	<b>94806</b>	LTR6AHX	91276	LTR6IX-11	6509					.052
<b>Transit Connect</b>													
2017	L4 2.5L		<b>ILTR5K13</b>	<b>90607</b>	LTR5AHX	90220	LTR5IX-11	4344	LTR5GP	5019			.052
2016	L4 1.6L		<b>ILZTR6A8G</b>	<b>94769</b>	LTR6BHX	90495							.032
	L4 2.5L		<b>ILTR5K13</b>	<b>90607</b>	LTR5AHX	90220	LTR5IX-11	4344	LTR5GP	5019			.052
2015-14	L4 1.6L		<b>ILZTR6A8G</b>	<b>94769</b>	LTR6BHX	90495							.032
	L4 2.5L	Naturally Aspirated	<b>ILTR5K13</b>	<b>90607</b>	LTR5AHX	90220	LTR5IX-11	4344	LTR5GP	5019			.052
2013-10	L4 2.0L		<b>ITR5H13</b>	<b>97287</b>	TR5AHX	94567	TR55IX	7164	TR55GP	3403	TR55	3951	.052
<b>Windstar</b>													
2003-01	V6 3.8L		PTR5C-13	7740			TR55IX	7164	TR55GP	3403	TR55	3951	.054
2000-96	V6 3.0L		PTR5F-11	6579			TR5IX	7397	TR5GP	3186	TR5	2238	.044
	V6 3.8L		PTR5C-13	7740			TR55IX	7164	TR55GP	3403	TR55	3951	.054
1995	V6 3.0L		PTR5F-11	6579			TR5IX	7397	TR5GP	3186	TR5	2238	.044
	V6 3.8L		TR55-1	2683			TR55-1IX	7316	TR55-1GP	7159	TR55-1	2683	.054
<b>FREIGHTLINER</b>													
<b>Sprinter 2500</b>													
2015-14	L4 2.1L	DIESEL	<b>CZ303</b>	<b>9970</b>									
	V6 3.0L	DIESEL	<b>CZ303</b>	<b>9970</b>									
2013	V6 3.0L	DIESEL	<b>CZ303</b>	<b>9970</b>									
2008-07	V6 3.5L		<b>PLKR7A</b>	<b>4288</b>	LKR7BHX	94705	LKR7AIX	93911	LKR7BGP-8	95983			.032
2006-02	L5 2.7L	DIESEL	Y-745U	4705									
<b>Sprinter 3500</b>													
2015-14	L4 2.1L	DIESEL	<b>CZ303</b>	<b>9970</b>									
	V6 3.0L	DIESEL	<b>CZ303</b>	<b>9970</b>									
2013	V6 3.0L	DIESEL	<b>CZ303</b>	<b>9970</b>									
2008-07	V6 3.5L		<b>PLKR7A</b>	<b>4288</b>	LKR7BHX	94705	LKR7AIX	93911	LKR7BGP-8	95983			.032
2006-02	L5 2.7L	DIESEL	Y-745U	4705									
<b>GENESIS</b>													
<b>G80</b>													
2018	V6 3.8L		<b>SILZKR7E11</b>	<b>92315</b>	LKR7AHX-S	96358	LKR7DIX-11S	93175					.044
2017	V6 3.8L		<b>DILKR7A11</b>	<b>93135</b>	LKR7AHX-S	96358	LKR7DIX-11S	93175	LKR7BGP-S	97390			.044
	V8 5.0L		<b>DILKR7A11</b>	<b>93135</b>	LKR7AHX-S	96358	LKR7DIX-11S	93175	LKR7BGP-S	97390			.044
<b>GEO</b>													
<b>Metro</b>													
1997-92	L3 1.0L		<b>BPR6ES-11</b>	<b>7133</b>			BPR6EIX-11	3903	BPR6EGP	7084	BPR6EY-11	6261	.042
	L4 1.3L		<b>BPR6ES-11</b>	<b>7133</b>			BPR6EIX-11	3903	BPR6EGP	7084	BPR6EY-11	6261	.042
1991-89	L3 1.0L		<b>BPR6ES-11</b>	<b>7133</b>			BPR6EIX-11	3903	BPR6EGP	7084	BPR6EY-11	6261	.042
<b>Prizm</b>													
1997	L4 1.6L		<b>BKR5EYA</b>	<b>2087</b>	FR5AHX	95839	BKR5EIX	6341	BKR5EGP	7090	BKR5EYA	2087	.032
	L4 1.8L		<b>BKR5EYA</b>	<b>2087</b>	FR5AHX	95839	BKR5EIX	6341	BKR5EGP	7090	BKR5EYA	2087	.032
1996-94	L4 1.6L		<b>BKR5EYA</b>	<b>2087</b>			BKR5EIX	6341	BKR5EGP	7090	BKR5EYA	2087	.032
	L4 1.8L		<b>BKR5EYA</b>	<b>2087</b>			BKR5EIX	6341	BKR5EGP	7090	BKR5EYA	2087	.032
1993	L4 1.6L		<b>BKR5EYA</b>	<b>2087</b>			BKR5EIX	6341	BKR5EGP	7090	BKR5EYA	2087	.032

**Bold denotes NGK OE Manufacturer and/or OE Service Part**  
NOT BOLD denotes OE Equivalent Part

**Le texte en gras désigne une pièce d'équipement originale du manufacturier NGK et/ou pièce d'équipement originale de service**  
Le texte non en gras désigne une pièce d'équipement originale équivalente

Note: Due to different operating or engine conditions, alternate heat range plugs may be required.

Note: En raison de différences au niveau du fonctionnement ou des conditions du moteur, d'autres types de bougies avec variation de chaleur peuvent être nécessaires



Year	Cyl. L	Notes	Original Equipment		Ruthenium HX		Iridium IX		G-Power		V-Power		Gap
			Part	Stock	Part	Stock	Part	Stock	Part	Stock	Part	Stock	
<b>GEO (Cont'd)</b>													
<b>Prizm (Cont'd)</b>													
1993	L4 1.8L		<b>BKR5EYA</b>	<b>2087</b>			BKR5EIX	6341	BKR5EGP	7090	BKR5EYA	2087	.032
1992-90	L4 1.6L	Eng Desg 4AFE	BCPR5EY	1266			BCPR5EIX	5688	BCPR5EGP	7086	BCPR5EY	1266	.032
		Eng Desg 4AGE	BKR6EP-8	2215			BKR6EIX	6418	BKR6EGP	7092	BKR6E	6962	.032
1989	L4 1.6L		<b>BKR5EYA-11</b>	<b>2526</b>			BKR5EIX-11	5464	BKR5EGP	7090	BKR5EYA-11	2526	.042
<b>Spectrum</b>													
1989	L4 1.5L		GR5	2851			GR5IX	7214	GR5GP	3351	GR5	2851	.045
<b>Storm</b>													
1993-92	L4 1.6L		<b>BPR6ES-11</b>	<b>7133</b>			BPR6EIX-11	3903	BPR6EGP	7084	BPR6EY-11	6261	.042
	L4 1.8L		<b>BKR5E-11</b>	<b>6953</b>			BKR5EIX-11	5464	BKR5EGP	7090	BKR5E-11	6953	.042
1991-90	L4 1.6L	Vin 5	<b>BKR6E-11</b>	<b>2756</b>			BKR6EIX-11	3764	BKR6EGP	7092	BKR6E-11	2756	.042
		Vin 6	<b>BPR6ES-11</b>	<b>7133</b>			BPR6EIX-11	3903	BPR6EGP	7084	BPR6EY-11	6261	.042
<b>Tracker</b>													
1997	L4 1.6L		<b>BKR6E</b>	<b>6962</b>	FR6AHX-S	94279	BKR6EIX	6418	BKR6EGP	7092	BKR6E	6962	.032
1996	L4 1.6L		<b>BKR6E</b>	<b>6962</b>			BKR6EIX	6418	BKR6EGP	7092	BKR6E	6962	.032
1995-94	L4 1.6L	Vin 6	<b>BKR6E</b>	<b>6962</b>			BKR6EIX	6418	BKR6EGP	7092	BKR6E	6962	.032
		Vin U	<b>BPR5ES</b>	<b>7734</b>			BPR5EIX	6597	BPR5EGP	7082	BPR5EY	1233	.032
1993-89	L4 1.6L		<b>BPR5ES</b>	<b>7734</b>			BPR5EIX	6597	BPR5EGP	7082	BPR5EY	1233	.032
<b>GMC</b>													
<b>Acadia</b>													
2018-17	L4 2.5L		<b>ILTR5L11</b>	<b>96329</b>	LTR5AHX	90220	LTR5IX-11	4344	LTR5GP	5019			.044
2016-07	V6 3.6L		<b>ILTR6E11</b>	<b>90117</b>	LTR6AHX	91276	LTR6IX-11	6509	LTR6GP	90198			.044
<b>Acadia Limited</b>													
2017	V6 3.6L	Carryover Model	<b>ILTR6E11</b>	<b>90117</b>	LTR6AHX	91276	LTR6IX-11	6509	LTR6GP	90198			.044
<b>C1500</b>													
1999	V8 5.0L		<b>ITR4A15</b>	<b>5599</b>	TR5AHX	94567	TR55IX	7164	TR55GP	3403	TR55	3951	.060
	V8 5.7L		<b>ITR4A15</b>	<b>5599</b>	TR5AHX	94567	TR55IX	7164	TR55GP	3403	TR55	3951	.060
1998-97	V6 4.3L		<b>ITR4A15</b>	<b>5599</b>	TR5AHX	94567	TR55IX	7164	TR55GP	3403	TR55	3951	.060
	V8 5.0L		<b>ITR4A15</b>	<b>5599</b>	TR5AHX	94567	TR55IX	7164	TR55GP	3403	TR55	3951	.060
	V8 5.7L		<b>ITR4A15</b>	<b>5599</b>	TR5AHX	94567	TR55IX	7164	TR55GP	3403	TR55	3951	.060
1996	V6 4.3L		<b>ITR4A15</b>	<b>5599</b>			TR55IX	7164	TR55GP	3403	TR55	3951	.060
	V8 5.0L		<b>ITR4A15</b>	<b>5599</b>			TR55IX	7164	TR55GP	3403	TR55	3951	.060
	V8 5.7L		<b>ITR4A15</b>	<b>5599</b>			TR55IX	7164	TR55GP	3403	TR55	3951	.060
1995-94	V6 4.3L		UR5	2771			UR5IX	7177	UR5GP	3547	UR5	2771	.045
	V8 5.0L		UR5	2771			UR5IX	7177	UR5GP	3547	UR5	2771	.045
	V8 5.7L		UR5	2771			UR5IX	7177	UR5GP	3547	UR5	2771	.035
1993	V6 4.3L		UR5	2771			UR5IX	7177	UR5GP	3547	UR5	2771	.035
	V8 5.0L		UR5	2771			UR5IX	7177	UR5GP	3547	UR5	2771	.045
	V8 5.7L		UR5	2771			UR5IX	7177	UR5GP	3547	UR5	2771	.035
1992-88	V6 4.3L		UR5	2771			UR5IX	7177	UR5GP	3547	UR5	2771	.035
	V8 5.0L		UR5	2771			UR5IX	7177	UR5GP	3547	UR5	2771	.035
	V8 5.7L		UR5	2771			UR5IX	7177	UR5GP	3547	UR5	2771	.035
1986-85	V6 4.3L		UR5	2771			UR5IX	7177	UR5GP	3547	UR5	2771	.035
	V8 5.0L	Vin F	UR5	2771			UR5IX	7177	UR5GP	3547	UR5	2771	.045
		Vin H	UR4	6630			UR4IX	7401	UR4GP	2869	UR4	6630	.045
	V8 5.7L	Vin L	UR5	2771			UR5IX	7177	UR5GP	3547	UR5	2771	.045
		Vin M	YR5	7052			YR5IX	7516	YR5GP	2953	YR5	7052	.045
<b>C1500 Suburban</b>													
1999-97	V8 5.7L		<b>ITR4A15</b>	<b>5599</b>	TR5AHX	94567	TR55IX	7164	TR55GP	3403	TR55	3951	.060
1996	V8 5.7L		<b>ITR4A15</b>	<b>5599</b>			TR55IX	7164	TR55GP	3403	TR55	3951	.060
1995-92	V8 5.7L		UR5	2771			UR5IX	7177	UR5GP	3547	UR5	2771	.035
1986-85	V8 5.0L	Vin F	UR5	2771			UR5IX	7177	UR5GP	3547	UR5	2771	.045
		Vin H	UR4	6630			UR4IX	7401	UR4GP	2869	UR4	6630	.045
	V8 5.7L	Vin L	UR5	2771			UR5IX	7177	UR5GP	3547	UR5	2771	.045
		Vin M	YR5	7052			YR5IX	7516	YR5GP	2953	YR5	7052	.045
<b>C2500</b>													
2000	V8 5.7L		<b>ITR4A15</b>	<b>5599</b>	TR5AHX	94567	TR55IX	7164	TR55GP	3403	TR55	3951	.060
	V8 7.4L		PTR4G-15	1209	TR5AHX	94567	TR55IX	7164	TR55GP	3403	TR55	3951	.060





Year	Cyl. L	Notes	Original Equipment		Ruthenium HX		Iridium IX		G-Power		V-Power		Gap
			Part	Stock	Part	Stock	Part	Stock	Part	Stock	Part	Stock	
<b>GMC (Cont'd)</b>													
<b>C2500 (Cont'd)</b>													
1999-97	V8 5.0L		<b>ITR4A15</b>	<b>5599</b>	TR5AHX	94567	TR55IX	7164	TR55GP	3403	TR55	3951	.060
	V8 5.7L		<b>ITR4A15</b>	<b>5599</b>	TR5AHX	94567	TR55IX	7164	TR55GP	3403	TR55	3951	.060
	V8 7.4L		PTR4G-15	1209	TR5AHX	94567	TR55IX	7164	TR55GP	3403	TR55	3951	.060
1996	V8 5.0L		<b>ITR4A15</b>	<b>5599</b>			TR55IX	7164	TR55GP	3403	TR55	3951	.060
	V8 5.7L		<b>ITR4A15</b>	<b>5599</b>			TR55IX	7164	TR55GP	3403	TR55	3951	.060
	V8 7.4L		PTR4G-15	1209			TR55IX	7164	TR55GP	3403	TR55	3951	.060
1995-94	V6 4.3L		UR5	2771			UR5IX	7177	UR5GP	3547	UR5	2771	.045
	V8 5.0L		UR5	2771			UR5IX	7177	UR5GP	3547	UR5	2771	.045
	V8 5.7L		UR5	2771			UR5IX	7177	UR5GP	3547	UR5	2771	.035
	V8 7.4L		UR5	2771			UR5IX	7177	UR5GP	3547	UR5	2771	.035
1993	V6 4.3L		UR5	2771			UR5IX	7177	UR5GP	3547	UR5	2771	.035
	V8 5.0L		UR5	2771			UR5IX	7177	UR5GP	3547	UR5	2771	.045
	V8 5.7L	GAS	UR5	2771			UR5IX	7177	UR5GP	3547	UR5	2771	.035
	V8 7.4L		UR5	2771			UR5IX	7177	UR5GP	3547	UR5	2771	.035
1992	V6 4.3L		UR5	2771			UR5IX	7177	UR5GP	3547	UR5	2771	.035
	V8 5.0L		UR5	2771			UR5IX	7177	UR5GP	3547	UR5	2771	.035
	V8 5.7L	GAS	UR5	2771			UR5IX	7177	UR5GP	3547	UR5	2771	.035
	V8 7.4L		UR5	2771			UR5IX	7177	UR5GP	3547	UR5	2771	.035
1991	V6 4.3L		UR5	2771			UR5IX	7177	UR5GP	3547	UR5	2771	.035
	V8 5.0L		UR5	2771			UR5IX	7177	UR5GP	3547	UR5	2771	.035
	V8 5.7L		UR5	2771			UR5IX	7177	UR5GP	3547	UR5	2771	.035
	V8 7.4L		UR5	2771			UR5IX	7177	UR5GP	3547	UR5	2771	.035
1990-88	V6 4.3L		UR5	2771			UR5IX	7177	UR5GP	3547	UR5	2771	.035
	V8 5.0L		UR5	2771			UR5IX	7177	UR5GP	3547	UR5	2771	.035
	V8 5.7L		UR5	2771			UR5IX	7177	UR5GP	3547	UR5	2771	.035
1986	L6 4.8L		YR5	7052			YR5IX	7516	YR5GP	2953	YR5	7052	.035
	V6 4.3L		UR5	2771			UR5IX	7177	UR5GP	3547	UR5	2771	.035
	V8 5.0L		UR4	6630			UR4IX	7401	UR4GP	2869	UR4	6630	.045
	V8 5.7L	Vin L	UR5	2771			UR5IX	7177	UR5GP	3547	UR5	2771	.045
	V8 7.4L	Vin M	YR5	7052			YR5IX	7516	YR5GP	2953	YR5	7052	.045
1985	V8 7.4L		YR5	7052			YR5IX	7516	YR5GP	2953	YR5	7052	.035
	L6 4.8L		YR5	7052			YR5IX	7516	YR5GP	2953	YR5	7052	.035
	V6 4.3L		UR5	2771			UR5IX	7177	UR5GP	3547	UR5	2771	.035
	V8 5.0L		UR4	6630			UR4IX	7401	UR4GP	2869	UR4	6630	.045
	V8 5.7L	Vin L	UR5	2771			UR5IX	7177	UR5GP	3547	UR5	2771	.045
V8 7.4L	Vin M	YR5	7052			YR5IX	7516	YR5GP	2953	YR5	7052	.045	
V8 7.4L		YR5	7052			YR5IX	7516	YR5GP	2953	YR5	7052	.045	
<b>C2500 Suburban</b>													
1999-97	V8 5.7L		<b>ITR4A15</b>	<b>5599</b>	TR5AHX	94567	TR55IX	7164	TR55GP	3403	TR55	3951	.060
	V8 7.4L		PTR4G-15	1209	TR5AHX	94567	TR55IX	7164	TR55GP	3403	TR55	3951	.060
1996	V8 5.7L		<b>ITR4A15</b>	<b>5599</b>			TR55IX	7164	TR55GP	3403	TR55	3951	.060
	V8 7.4L		PTR4G-15	1209			TR55IX	7164	TR55GP	3403	TR55	3951	.060
1995-92	V8 5.7L		UR5	2771			UR5IX	7177	UR5GP	3547	UR5	2771	.035
	V8 7.4L		UR5	2771			UR5IX	7177	UR5GP	3547	UR5	2771	.035
1986-85	V8 5.0L		UR4	6630			UR4IX	7401	UR4GP	2869	UR4	6630	.045
	V8 5.7L	Vin L	UR5	2771			UR5IX	7177	UR5GP	3547	UR5	2771	.045
	V8 7.4L	Vin M	YR5	7052			YR5IX	7516	YR5GP	2953	YR5	7052	.045
V8 7.4L		YR5	7052			YR5IX	7516	YR5GP	2953	YR5	7052	.045	
<b>C3500</b>													
2000-97	V8 5.7L		<b>ITR4A15</b>	<b>5599</b>	TR5AHX	94567	TR55IX	7164	TR55GP	3403	TR55	3951	.060
	V8 7.4L		PTR4G-15	1209	TR5AHX	94567	TR55IX	7164	TR55GP	3403	TR55	3951	.060
1996	V8 5.7L		<b>ITR4A15</b>	<b>5599</b>			TR55IX	7164	TR55GP	3403	TR55	3951	.060
	V8 7.4L		PTR4G-15	1209			TR55IX	7164	TR55GP	3403	TR55	3951	.060
1995-88	V8 5.7L		UR5	2771			UR5IX	7177	UR5GP	3547	UR5	2771	.035
	V8 7.4L		UR5	2771			UR5IX	7177	UR5GP	3547	UR5	2771	.035
1986	L6 4.8L		YR5	7052			YR5IX	7516	YR5GP	2953	YR5	7052	.035
	V8 5.0L		UR4	6630			UR4IX	7401	UR4GP	2869	UR4	6630	.045

**Bold denotes NGK OE Manufacturer and/or OE Service Part**  
NOT BOLD denotes OE Equivalent Part

**Le texte en gras désigne une pièce d'équipement originale du manufacturier NGK et/ou pièce d'équipement originale de service**  
Le texte non en gras désigne une pièce d'équipement originale équivalente

Note: Due to different operating or engine conditions, alternate heat range plugs may be required.

Note: En raison de différences au niveau du fonctionnement ou des conditions du moteur, d'autres types de bougies avec variation de chaleur peuvent être nécessaires



Year	Cyl. L	Notes	Original Equipment		Ruthenium HX		Iridium IX		G-Power		V-Power		Gap
			Part	Stock	Part	Stock	Part	Stock	Part	Stock	Part	Stock	
<b>GMC (Cont'd)</b>													
<b>C3500 (Cont'd)</b>													
1986	V8 5.7L		YR5	7052			YR5IX	7516	YR5GP	2953	YR5	7052	.045
	V8 7.4L		YR5	7052			YR5IX	7516	YR5GP	2953	YR5	7052	.045
1985	L6 4.8L		YR5	7052			YR5IX	7516	YR5GP	2953	YR5	7052	.035
	V8 5.7L		YR5	7052			YR5IX	7516	YR5GP	2953	YR5	7052	.045
	V8 7.4L		YR5	7052			YR5IX	7516	YR5GP	2953	YR5	7052	.045
<b>C3500HD</b>													
2002-01	V8 8.1L		<b>PZTR5A-15</b>	<b>7862</b>	TR5AHX	94567	TR55IX	7164	TR55GP	3403	TR55	3951	.060
2000-97	V8 7.4L		PTR4G-15	1209	TR5AHX	94567	TR55IX	7164	TR55GP	3403	TR55	3951	.060
1996	V8 7.4L		PTR4G-15	1209			TR55IX	7164	TR55GP	3403	TR55	3951	.060
1995-91	V8 5.7L		UR5	2771			UR5IX	7177	UR5GP	3547	UR5	2771	.035
	V8 7.4L		UR5	2771			UR5IX	7177	UR5GP	3547	UR5	2771	.035
<b>C4500 Topkick</b>													
2009-08	V8 6.6L	DIESEL	Y1033AS	90046									
	V8 8.1L		PZTR5A-15	7862	TR5AHX	94567	TR55IX	7164	TR55GP	3403	TR55	3951	.060
2007	V8 6.6L	DIESEL	Y1033AS	90046									
2006	V8 6.6L	DIESEL, w/ Hex Threads Located Middle of Glow Plug	Y1033AS	90046									
		DIESEL, w/ Hex Threads Located Near Top of Glow Plug (LLY Engine Only)	Y1032AS	97788									
2005	V8 6.6L	DIESEL	Y1032AS	97788									
2004	V8 6.6L	Vin 2, DIESEL	Y1032AS	97788									
<b>C5500 Topkick</b>													
2009-08	V8 6.6L	DIESEL	Y1033AS	90046									
	V8 8.1L		PZTR5A-15	7862	TR5AHX	94567	TR55IX	7164	TR55GP	3403	TR55	3951	.060
2007	V8 6.6L	DIESEL	Y1033AS	90046									
2006	V8 6.6L	DIESEL, w/ Hex Threads Located Middle of Glow Plug	Y1033AS	90046									
		DIESEL, w/ Hex Threads Located Near Top of Glow Plug (LLY Engine Only)	Y1032AS	97788									
2005	V8 6.6L	DIESEL	Y1032AS	97788									
2004	V8 6.6L	Vin 2, DIESEL	Y1032AS	97788									
<b>C6500 Topkick</b>													
2009-08	V8 8.1L		PZTR5A-15	7862	TR5AHX	94567	TR55IX	7164	TR55GP	3403	TR55	3951	.060
2000-99	V8 7.4L		PTR4G-15	1209	TR5AHX	94567	TR55IX	7164	TR55GP	3403	TR55	3951	.060
<b>C7500 Topkick</b>													
2009-08	V8 8.1L		PZTR5A-15	7862	TR5AHX	94567	TR55IX	7164	TR55GP	3403	TR55	3951	.060
2000-99	V8 7.4L		PTR4G-15	1209	TR5AHX	94567	TR55IX	7164	TR55GP	3403	TR55	3951	.060
<b>Caballero</b>													
1987	V6 4.3L		UR4	6630			UR4IX	7401	UR4GP	2869	UR4	6630	.035
	V8 5.0L		UR4	6630			UR4IX	7401	UR4GP	2869	UR4	6630	.045
1986	V6 4.3L		UR4	6630			UR4IX	7401	UR4GP	2869	UR4	6630	.035
	V8 5.0L		UR5	2771			UR5IX	7177	UR5GP	3547	UR5	2771	.045
1985	V6 4.3L		UR4	6630			UR4IX	7401	UR4GP	2869	UR4	6630	.035
	V8 5.0L		UR4	6630			UR4IX	7401	UR4GP	2869	UR4	6630	.045
<b>Canyon</b>													
2018-17	L4 2.5L		<b>ILTR5L11</b>	<b>96329</b>	LTR5AHX	90220	LTR5IX-11	4344	LTR5GP	5019			.044
2016-15	L4 2.5L		<b>ILTR5L11</b>	<b>96329</b>	LTR5AHX	90220	LTR5IX-11	4344	LTR5GP	5019			.044
	V6 3.6L		<b>ILTR6E11</b>	<b>90117</b>	LTR6AHX	91276	LTR6IX-11	6509	LTR6GP	90198			.044
2012-09	L4 2.9L		<b>ILTR5E11</b>	<b>91418</b>	LTR5AHX	90220	LTR5IX-11	4344	LTR5GP	5019			.044
	L5 3.7L		<b>ILTR5E11</b>	<b>91418</b>	LTR5AHX	90220	LTR5IX-11	4344	LTR5GP	5019			.044
	V8 5.3L		IZTR5B11	1465	TR5AHX	94567	TR5IX	7397	TR5GP	3186	TR5	2238	.040
2008-07	L4 2.9L		<b>ILTR5E11</b>	<b>91418</b>	LTR5AHX	90220	LTR5IX-11	4344	LTR5GP	5019			.044
	L5 3.7L		<b>ILTR5E11</b>	<b>91418</b>	LTR5AHX	90220	LTR5IX-11	4344	LTR5GP	5019			.044



Year	Cyl. L	Notes	Original Equipment		Ruthenium HX		Iridium IX		G-Power		V-Power		Gap
			Part	Stock	Part	Stock	Part	Stock	Part	Stock	Part	Stock	
<b>GMC (Cont'd)</b>													
<b>Canyon (Cont'd)</b>													
2006-04	L4 2.8L		<b>ILTR5E11</b>	<b>91418</b>	LTR5AHX	90220	LTR5IX-11	4344	LTR5GP	5019			.044
	L5 3.5L		<b>ILTR5E11</b>	<b>91418</b>	LTR5AHX	90220	LTR5IX-11	4344	LTR5GP	5019			.044
<b>Envoy</b>													
2009-05	L6 4.2L		<b>ILTR5E11</b>	<b>91418</b>	LTR5AHX	90220	LTR5IX-11	4344	LTR5GP	5019			.044
	V8 5.3L		IZTR5B11	1465	TR5AHX	94567	TR5IX	7397	TR5GP	3186	TR5	2238	.040
2004-02	L6 4.2L		<b>ILTR5E11</b>	<b>91418</b>	LTR5AHX	90220	LTR5IX-11	4344	LTR5GP	5019			.044
<b>Envoy XL</b>													
2006-03	L6 4.2L		<b>ILTR5E11</b>	<b>91418</b>	LTR5AHX	90220	LTR5IX-11	4344	LTR5GP	5019			.044
	V8 5.3L		IZTR5B11	1465	TR5AHX	94567	TR5IX	7397	TR5GP	3186	TR5	2238	.040
2002	L6 4.2L		<b>ILTR5E11</b>	<b>91418</b>	LTR5AHX	90220	LTR5IX-11	4344	LTR5GP	5019			.044
<b>Envoy XUV</b>													
2005-04	L6 4.2L		<b>ILTR5E11</b>	<b>91418</b>	LTR5AHX	90220	LTR5IX-11	4344	LTR5GP	5019			.044
	V8 5.3L		IZTR5B11	1465	TR5AHX	94567	TR5IX	7397	TR5GP	3186	TR5	2238	.040
<b>G1500</b>													
1995-94	V6 4.3L		UR5	2771			UR5IX	7177	UR5GP	3547	UR5	2771	.045
	V8 5.0L		UR5	2771			UR5IX	7177	UR5GP	3547	UR5	2771	.035
1993-87	V6 4.3L		UR5	2771			UR5IX	7177	UR5GP	3547	UR5	2771	.035
	V8 5.0L		UR5	2771			UR5IX	7177	UR5GP	3547	UR5	2771	.035
	V8 5.7L		UR5	2771			UR5IX	7177	UR5GP	3547	UR5	2771	.035
1986-85	V6 4.3L		UR5	2771			UR5IX	7177	UR5GP	3547	UR5	2771	.035
	V8 5.0L		UR5	2771			UR5IX	7177	UR5GP	3547	UR5	2771	.045
	V8 5.7L		UR5	2771			UR5IX	7177	UR5GP	3547	UR5	2771	.045
<b>G2500</b>													
1995-94	V6 4.3L		UR5	2771			UR5IX	7177	UR5GP	3547	UR5	2771	.045
	V8 5.0L		UR5	2771			UR5IX	7177	UR5GP	3547	UR5	2771	.035
	V8 5.7L		UR5	2771			UR5IX	7177	UR5GP	3547	UR5	2771	.035
1993-87	V6 4.3L		UR5	2771			UR5IX	7177	UR5GP	3547	UR5	2771	.035
	V8 5.0L		UR5	2771			UR5IX	7177	UR5GP	3547	UR5	2771	.035
	V8 5.7L		UR5	2771			UR5IX	7177	UR5GP	3547	UR5	2771	.035
1986-85	V6 4.3L		UR5	2771			UR5IX	7177	UR5GP	3547	UR5	2771	.035
	V8 5.0L		UR5	2771			UR5IX	7177	UR5GP	3547	UR5	2771	.045
	V8 5.7L	Vin L	UR5	2771			UR5IX	7177	UR5GP	3547	UR5	2771	.045
		Vin M	YR5	7052			YR5IX	7516	YR5GP	2953	YR5	7052	.045
<b>G3500</b>													
1996	V8 5.7L	Vin K, TBI(FuelSystDesi.)	UR5	2771			UR5IX	7177	UR5GP	3547	UR5	2771	.035
	V8 7.4L	Vin N, TBI(FuelSystDesi.)	UR5	2771			UR5IX	7177	UR5GP	3547	UR5	2771	.035
1995-94	V6 4.3L		UR5	2771			UR5IX	7177	UR5GP	3547	UR5	2771	.045
	V8 5.7L		UR5	2771			UR5IX	7177	UR5GP	3547	UR5	2771	.035
	V8 7.4L		UR5	2771			UR5IX	7177	UR5GP	3547	UR5	2771	.035
1993-89	V6 4.3L		UR5	2771			UR5IX	7177	UR5GP	3547	UR5	2771	.035
	V8 5.7L		UR5	2771			UR5IX	7177	UR5GP	3547	UR5	2771	.035
	V8 7.4L		UR5	2771			UR5IX	7177	UR5GP	3547	UR5	2771	.035
1988	V6 4.3L		UR5	2771			UR5IX	7177	UR5GP	3547	UR5	2771	.035
	V8 5.7L	CARB	YR5	7052			YR5IX	7516	YR5GP	2953	YR5	7052	.045
		FI	UR5	2771			UR5IX	7177	UR5GP	3547	UR5	2771	.035
	V8 7.4L		UR5	2771			UR5IX	7177	UR5GP	3547	UR5	2771	.035
1987	V6 4.3L		UR5	2771			UR5IX	7177	UR5GP	3547	UR5	2771	.035
	V8 5.7L	CARB	YR5	7052			YR5IX	7516	YR5GP	2953	YR5	7052	.045
		FI	UR5	2771			UR5IX	7177	UR5GP	3547	UR5	2771	.035
1986-85	V6 4.3L		UR5	2771			UR5IX	7177	UR5GP	3547	UR5	2771	.035
	V8 5.7L	Vin L	UR5	2771			UR5IX	7177	UR5GP	3547	UR5	2771	.045
		Vin M	YR5	7052			YR5IX	7516	YR5GP	2953	YR5	7052	.045
<b>Jimmy</b>													
2005-98	V6 4.3L		<b>ITR4A15</b>	<b>5599</b>	TR5AHX	94567	TR55IX	7164	TR55GP	3403	TR55	3951	.060
1997	V6 4.3L		PZTR5A-15	7862	TR5AHX	94567	TR55IX	7164	TR55GP	3403	TR55	3951	.060
1996	V6 4.3L		PZTR5A-15	7862			TR55IX	7164	TR55GP	3403	TR55	3951	.060

**Bold denotes NGK OE Manufacturer and/or OE Service Part**  
NOT BOLD denotes OE Equivalent Part

**Le texte en gras désigne une pièce d'équipement originale du manufacturier NGK et/ou pièce d'équipement originale de service**  
Le texte non en gras désigne une pièce d'équipement originale équivalente

Note: Due to different operating or engine conditions, alternate heat range plugs may be required.

Note: En raison de différences au niveau du fonctionnement ou des conditions du moteur, d'autres types de bougies avec variation de chaleur peuvent être nécessaires



Year	Cyl. L	Notes	Original Equipment		Ruthenium HX		Iridium IX		G-Power		V-Power		Gap
			Part	Stock	Part	Stock	Part	Stock	Part	Stock	Part	Stock	
<b>GMC (Cont'd)</b>													
<b>Jimmy (Cont'd)</b>													
1995-92	V6 4.3L		UR5	2771			UR5IX	7177	UR5GP	3547	UR5	2771	.045
1991-88	V8 5.7L		UR5	2771			UR5IX	7177	UR5GP	3547	UR5	2771	.035
1987	V8 5.0L		UR5	2771			UR5IX	7177	UR5GP	3547	UR5	2771	.035
	V8 5.7L		UR5	2771			UR5IX	7177	UR5GP	3547	UR5	2771	.035
1986-85	V8 5.0L		UR4	6630			UR4IX	7401	UR4GP	2869	UR4	6630	.045
	V8 5.7L		UR5	2771			UR5IX	7177	UR5GP	3547	UR5	2771	.045
<b>K1500</b>													
1999	V8 5.0L		<b>ITR4A15</b>	<b>5599</b>	TR5AHX	94567	TR55IX	7164	TR55GP	3403	TR55	3951	.060
	V8 5.7L		<b>ITR4A15</b>	<b>5599</b>	TR5AHX	94567	TR55IX	7164	TR55GP	3403	TR55	3951	.060
1998-97	V6 4.3L		<b>ITR4A15</b>	<b>5599</b>	TR5AHX	94567	TR55IX	7164	TR55GP	3403	TR55	3951	.060
	V8 5.0L		<b>ITR4A15</b>	<b>5599</b>	TR5AHX	94567	TR55IX	7164	TR55GP	3403	TR55	3951	.060
	V8 5.7L		<b>ITR4A15</b>	<b>5599</b>	TR5AHX	94567	TR55IX	7164	TR55GP	3403	TR55	3951	.060
1996	V6 4.3L		<b>ITR4A15</b>	<b>5599</b>			TR55IX	7164	TR55GP	3403	TR55	3951	.060
	V8 5.0L		<b>ITR4A15</b>	<b>5599</b>			TR55IX	7164	TR55GP	3403	TR55	3951	.060
	V8 5.7L		<b>ITR4A15</b>	<b>5599</b>			TR55IX	7164	TR55GP	3403	TR55	3951	.060
1995-94	V6 4.3L		UR5	2771			UR5IX	7177	UR5GP	3547	UR5	2771	.045
	V8 5.0L		UR5	2771			UR5IX	7177	UR5GP	3547	UR5	2771	.035
	V8 5.7L		UR5	2771			UR5IX	7177	UR5GP	3547	UR5	2771	.035
1993-88	V6 4.3L		UR5	2771			UR5IX	7177	UR5GP	3547	UR5	2771	.035
	V8 5.0L		UR5	2771			UR5IX	7177	UR5GP	3547	UR5	2771	.035
	V8 5.7L		UR5	2771			UR5IX	7177	UR5GP	3547	UR5	2771	.035
1986	V6 4.3L		UR5	2771			UR5IX	7177	UR5GP	3547	UR5	2771	.035
	V8 5.0L		UR4	6630			UR4IX	7401	UR4GP	2869	UR4	6630	.045
	V8 5.7L	Vin L	UR5	2771			UR5IX	7177	UR5GP	3547	UR5	2771	.045
1985	V6 4.3L		UR5	2771			UR5IX	7177	UR5GP	3547	UR5	2771	.035
	V8 5.0L		UR4	6630			UR4IX	7401	UR4GP	2869	UR4	6630	.045
	V8 5.7L	Vin L	UR5	2771			UR5IX	7177	UR5GP	3547	UR5	2771	.045
		Vin M	YR5	7052			YR5IX	7516	YR5GP	2953	YR5	7052	.045
<b>K1500 Suburban</b>													
1999-97	V8 5.7L		<b>ITR4A15</b>	<b>5599</b>	TR5AHX	94567	TR55IX	7164	TR55GP	3403	TR55	3951	.060
1996	V8 5.7L		<b>ITR4A15</b>	<b>5599</b>			TR55IX	7164	TR55GP	3403	TR55	3951	.060
1995-92	V8 5.7L		UR5	2771			UR5IX	7177	UR5GP	3547	UR5	2771	.035
1986	V8 5.7L		UR5	2771			UR5IX	7177	UR5GP	3547	UR5	2771	.045
1985	V8 5.0L		UR5	2771			UR5IX	7177	UR5GP	3547	UR5	2771	.045
	V8 5.7L		UR5	2771			UR5IX	7177	UR5GP	3547	UR5	2771	.045
<b>K2500</b>													
2000-99	V8 5.7L		<b>ITR4A15</b>	<b>5599</b>	TR5AHX	94567	TR55IX	7164	TR55GP	3403	TR55	3951	.060
	V8 7.4L		PTR4G-15	1209	TR5AHX	94567	TR55IX	7164	TR55GP	3403	TR55	3951	.060
1998	V8 5.0L		<b>ITR4A15</b>	<b>5599</b>	TR5AHX	94567	TR55IX	7164	TR55GP	3403	TR55	3951	.060
	V8 5.7L		<b>ITR4A15</b>	<b>5599</b>	TR5AHX	94567	TR55IX	7164	TR55GP	3403	TR55	3951	.060
	V8 7.4L		PTR4G-15	1209	TR5AHX	94567	TR55IX	7164	TR55GP	3403	TR55	3951	.060
1997	V8 5.7L		<b>ITR4A15</b>	<b>5599</b>	TR5AHX	94567	TR55IX	7164	TR55GP	3403	TR55	3951	.060
	V8 7.4L		PTR4G-15	1209	TR5AHX	94567	TR55IX	7164	TR55GP	3403	TR55	3951	.060
1996	V8 5.7L		<b>ITR4A15</b>	<b>5599</b>			TR55IX	7164	TR55GP	3403	TR55	3951	.060
	V8 7.4L		PTR4G-15	1209			TR55IX	7164	TR55GP	3403	TR55	3951	.060
1995-94	V6 4.3L		UR5	2771			UR5IX	7177	UR5GP	3547	UR5	2771	.045
	V8 5.0L		UR5	2771			UR5IX	7177	UR5GP	3547	UR5	2771	.035
	V8 5.7L		UR5	2771			UR5IX	7177	UR5GP	3547	UR5	2771	.035
	V8 7.4L		UR5	2771			UR5IX	7177	UR5GP	3547	UR5	2771	.035
1993-92	V6 4.3L		UR5	2771			UR5IX	7177	UR5GP	3547	UR5	2771	.035
	V8 5.0L		UR5	2771			UR5IX	7177	UR5GP	3547	UR5	2771	.035
	V8 5.7L	GAS	UR5	2771			UR5IX	7177	UR5GP	3547	UR5	2771	.035
	V8 7.4L		UR5	2771			UR5IX	7177	UR5GP	3547	UR5	2771	.035
1991	V6 4.3L		UR5	2771			UR5IX	7177	UR5GP	3547	UR5	2771	.035
	V8 5.0L		UR5	2771			UR5IX	7177	UR5GP	3547	UR5	2771	.035
	V8 5.7L		UR5	2771			UR5IX	7177	UR5GP	3547	UR5	2771	.035
	V8 7.4L		UR5	2771			UR5IX	7177	UR5GP	3547	UR5	2771	.035



Year	Cyl. L	Notes	Original Equipment		Ruthenium HX		Iridium IX		G-Power		V-Power		Gap
			Part	Stock	Part	Stock	Part	Stock	Part	Stock	Part	Stock	
<b>GMC (Cont'd)</b>													
<b>K2500 (Cont'd)</b>													
1990-88	V6 4.3L		UR5	2771			UR5IX	7177	UR5GP	3547	UR5	2771	.035
	V8 5.0L		UR5	2771			UR5IX	7177	UR5GP	3547	UR5	2771	.035
	V8 5.7L		UR5	2771			UR5IX	7177	UR5GP	3547	UR5	2771	.035
1986	L6 4.8L		YR5	7052			YR5IX	7516	YR5GP	2953	YR5	7052	.035
	V8 5.7L	Vin L	UR5	2771			UR5IX	7177	UR5GP	3547	UR5	2771	.045
		Vin M	YR5	7052			YR5IX	7516	YR5GP	2953	YR5	7052	.045
1985	L6 4.8L		UR4	6630			UR4IX	7401	UR4GP	2869	UR4	6630	.035
	V6 4.3L		UR5	2771			UR5IX	7177	UR5GP	3547	UR5	2771	.035
	V8 5.7L	Vin L	UR5	2771			UR5IX	7177	UR5GP	3547	UR5	2771	.045
		Vin M	YR5	7052			YR5IX	7516	YR5GP	2953	YR5	7052	.045
<b>K2500 Suburban</b>													
1999-97	V8 5.7L		<b>ITR4A15</b>	<b>5599</b>	TR5AHX	94567	TR55IX	7164	TR55GP	3403	TR55	3951	.060
	V8 7.4L		PTR4G-15	1209	TR5AHX	94567	TR55IX	7164	TR55GP	3403	TR55	3951	.060
1996	V8 5.7L		<b>ITR4A15</b>	<b>5599</b>			TR55IX	7164	TR55GP	3403	TR55	3951	.060
	V8 7.4L		PTR4G-15	1209			TR55IX	7164	TR55GP	3403	TR55	3951	.060
1995-92	V8 5.7L		UR5	2771			UR5IX	7177	UR5GP	3547	UR5	2771	.035
	V8 7.4L		UR5	2771			UR5IX	7177	UR5GP	3547	UR5	2771	.035
1986-85	V8 5.7L		YR5	7052			YR5IX	7516	YR5GP	2953	YR5	7052	.045
<b>K3500</b>													
2000-97	V8 5.7L		<b>ITR4A15</b>	<b>5599</b>	TR5AHX	94567	TR55IX	7164	TR55GP	3403	TR55	3951	.060
	V8 7.4L		PTR4G-15	1209	TR5AHX	94567	TR55IX	7164	TR55GP	3403	TR55	3951	.060
1996	V8 5.7L		<b>ITR4A15</b>	<b>5599</b>			TR55IX	7164	TR55GP	3403	TR55	3951	.060
	V8 7.4L		PTR4G-15	1209			TR55IX	7164	TR55GP	3403	TR55	3951	.060
1995-88	V8 5.7L		UR5	2771			UR5IX	7177	UR5GP	3547	UR5	2771	.035
	V8 7.4L		UR5	2771			UR5IX	7177	UR5GP	3547	UR5	2771	.035
1986-85	L6 4.8L		YR5	7052			YR5IX	7516	YR5GP	2953	YR5	7052	.035
	V8 5.7L		YR5	7052			YR5IX	7516	YR5GP	2953	YR5	7052	.045
	V8 7.4L		YR5	7052			YR5IX	7516	YR5GP	2953	YR5	7052	.045
<b>P2500</b>													
1989	L6 4.8L		YR5	7052			YR5IX	7516	YR5GP	2953	YR5	7052	.035
	V8 5.7L		UR5	2771			UR5IX	7177	UR5GP	3547	UR5	2771	.035
1988	V8 5.7L		UR5	2771			UR5IX	7177	UR5GP	3547	UR5	2771	.035
1987-85	L6 4.8L		YR5	7052			YR5IX	7516	YR5GP	2953	YR5	7052	.035
	V8 5.7L		YR5	7052			YR5IX	7516	YR5GP	2953	YR5	7052	.045
<b>P3500</b>													
1999-98	V6 4.3L		<b>ITR4A15</b>	<b>5599</b>	TR5AHX	94567	TR55IX	7164	TR55GP	3403	TR55	3951	.060
	V8 5.7L		<b>ITR4A15</b>	<b>5599</b>	TR5AHX	94567	TR55IX	7164	TR55GP	3403	TR55	3951	.060
	V8 7.4L	Vin B, MPI(FuelSystDesi.)	<b>ITR4A15</b>	<b>5599</b>	TR5AHX	94567	TR55IX	7164	TR55GP	3403	TR55	3951	.060
		Vin J, SFI(FuelSystDesi.)	PTR4G-15	1209	TR5AHX	94567	TR55IX	7164	TR55GP	3403	TR55	3951	.060
1997	V6 4.3L		PZTR5A-15	7862	TR5AHX	94567	TR55IX	7164	TR55GP	3403	TR55	3951	.060
	V8 5.7L		<b>ITR4A15</b>	<b>5599</b>	TR5AHX	94567	TR55IX	7164	TR55GP	3403	TR55	3951	.060
	V8 7.4L	Vin J, SFI(FuelSystDesi.)	PTR4G-15	1209	TR5AHX	94567	TR55IX	7164	TR55GP	3403	TR55	3951	.060
		Vin N, TBI(FuelSystDesi.)	UR5	2771			UR5IX	7177	UR5GP	3547	UR5	2771	.035
1996	V6 4.3L		PZTR5A-15	7862			TR55IX	7164	TR55GP	3403	TR55	3951	.060
	V8 5.7L	Vin K, TBI(FuelSystDesi.)	UR5	2771			UR5IX	7177	UR5GP	3547	UR5	2771	.035
		Vin R, Central SFI(FuelSystDesi.)	<b>ITR4A15</b>	<b>5599</b>			TR55IX	7164	TR55GP	3403	TR55	3951	.060
	V8 7.4L	Vin J, SFI(FuelSystDesi.)	PTR4G-15	1209			TR55IX	7164	TR55GP	3403	TR55	3951	.060
		Vin N, TBI(FuelSystDesi.)	UR5	2771			UR5IX	7177	UR5GP	3547	UR5	2771	.035
1995-94	V6 4.3L		UR5	2771			UR5IX	7177	UR5GP	3547	UR5	2771	.045
	V8 5.7L		UR5	2771			UR5IX	7177	UR5GP	3547	UR5	2771	.035
	V8 7.4L		UR5	2771			UR5IX	7177	UR5GP	3547	UR5	2771	.035
1993-90	V6 4.3L		UR5	2771			UR5IX	7177	UR5GP	3547	UR5	2771	.035

**Bold denotes NGK OE Manufacturer and/or OE Service Part**  
NOT BOLD denotes OE Equivalent Part

**Le texte en gras désigne une pièce d'équipement originale du manufacturier NGK et/ou pièce d'équipement originale de service**  
Le texte non en gras désigne une pièce d'équipement originale équivalente

Note: Due to different operating or engine conditions, alternate heat range plugs may be required.

Note: En raison de différences au niveau du fonctionnement ou des conditions du moteur, d'autres types de bougies avec variation de chaleur peuvent être nécessaires





Year	Cyl. L	Notes	Original Equipment		Ruthenium HX		Iridium IX		G-Power		V-Power		Gap
			Part	Stock	Part	Stock	Part	Stock	Part	Stock	Part	Stock	
<b>GMC (Cont'd)</b>													
<b>P3500 (Cont'd)</b>													
1993-90	V8 5.7L		UR5	2771			UR5IX	7177	UR5GP	3547	UR5	2771	.035
	V8 7.4L		UR5	2771			UR5IX	7177	UR5GP	3547	UR5	2771	.035
1989	L6 4.8L		YR5	7052			YR5IX	7516	YR5GP	2953	YR5	7052	.035
	V8 5.7L		UR5	2771			UR5IX	7177	UR5GP	3547	UR5	2771	.035
	V8 7.4L		YR5	7052			YR5IX	7516	YR5GP	2953	YR5	7052	.045
1988-87	L6 4.8L		YR5	7052			YR5IX	7516	YR5GP	2953	YR5	7052	.035
	V8 5.7L	CARB	YR5	7052			YR5IX	7516	YR5GP	2953	YR5	7052	.045
		FI	UR5	2771			UR5IX	7177	UR5GP	3547	UR5	2771	.035
	V8 7.4L		YR5	7052			YR5IX	7516	YR5GP	2953	YR5	7052	.045
1986-85	L6 4.8L		YR5	7052			YR5IX	7516	YR5GP	2953	YR5	7052	.035
	V8 5.7L		YR5	7052			YR5IX	7516	YR5GP	2953	YR5	7052	.045
	V8 7.4L		YR5	7052			YR5IX	7516	YR5GP	2953	YR5	7052	.045
<b>R1500</b>													
1987	V6 4.3L		UR5	2771			UR5IX	7177	UR5GP	3547	UR5	2771	.035
	V8 5.0L		UR5	2771			UR5IX	7177	UR5GP	3547	UR5	2771	.035
	V8 5.7L		UR5	2771			UR5IX	7177	UR5GP	3547	UR5	2771	.035
<b>R1500 Suburban</b>													
1991-88	V8 5.7L		UR5	2771			UR5IX	7177	UR5GP	3547	UR5	2771	.035
1987	V8 5.0L		UR5	2771			UR5IX	7177	UR5GP	3547	UR5	2771	.035
	V8 5.7L		UR5	2771			UR5IX	7177	UR5GP	3547	UR5	2771	.035
<b>R2500</b>													
1989	V8 5.7L		UR5	2771			UR5IX	7177	UR5GP	3547	UR5	2771	.035
	V8 7.4L		UR5	2771			UR5IX	7177	UR5GP	3547	UR5	2771	.035
1988	L6 4.8L		YR5	7052			YR5IX	7516	YR5GP	2953	YR5	7052	.035
	V8 5.7L		UR5	2771			UR5IX	7177	UR5GP	3547	UR5	2771	.035
	V8 7.4L		UR5	2771			UR5IX	7177	UR5GP	3547	UR5	2771	.035
1987	L6 4.8L		YR5	7052			YR5IX	7516	YR5GP	2953	YR5	7052	.035
	V6 4.3L		UR5	2771			UR5IX	7177	UR5GP	3547	UR5	2771	.035
	V8 5.0L		UR5	2771			UR5IX	7177	UR5GP	3547	UR5	2771	.035
	V8 5.7L		UR5	2771			UR5IX	7177	UR5GP	3547	UR5	2771	.035
	V8 7.4L		UR5	2771			UR5IX	7177	UR5GP	3547	UR5	2771	.035
<b>R2500 Suburban</b>													
1991-87	V8 5.7L		UR5	2771			UR5IX	7177	UR5GP	3547	UR5	2771	.035
	V8 7.4L		UR5	2771			UR5IX	7177	UR5GP	3547	UR5	2771	.035
<b>R3500</b>													
1991-90	V8 5.7L		UR5	2771			UR5IX	7177	UR5GP	3547	UR5	2771	.035
	V8 7.4L		UR5	2771			UR5IX	7177	UR5GP	3547	UR5	2771	.035
1989	V8 5.7L		UR5	2771			UR5IX	7177	UR5GP	3547	UR5	2771	.035
	V8 7.4L	CARB	YR5	7052			YR5IX	7516	YR5GP	2953	YR5	7052	.045
		FI	UR5	2771			UR5IX	7177	UR5GP	3547	UR5	2771	.035
1988	L6 4.8L		YR5	7052			YR5IX	7516	YR5GP	2953	YR5	7052	.035
	V8 5.7L	CARB	YR5	7052			YR5IX	7516	YR5GP	2953	YR5	7052	.035
		FI	UR5	2771			UR5IX	7177	UR5GP	3547	UR5	2771	.035
	V8 7.4L	CARB	YR5	7052			YR5IX	7516	YR5GP	2953	YR5	7052	.045
		FI	UR5	2771			UR5IX	7177	UR5GP	3547	UR5	2771	.035
1987	L6 4.8L		YR5	7052			YR5IX	7516	YR5GP	2953	YR5	7052	.035
	V8 5.7L	CARB	YR5	7052			YR5IX	7516	YR5GP	2953	YR5	7052	.035
		FI	UR5	2771			UR5IX	7177	UR5GP	3547	UR5	2771	.035
	V8 7.4L	CARB	YR5	7052			YR5IX	7516	YR5GP	2953	YR5	7052	.035
		FI	UR5	2771			UR5IX	7177	UR5GP	3547	UR5	2771	.035
<b>S15</b>													
1990-88	L4 2.5L		UR55	2248			UR55IX	7272			UR55	2248	.060
	V6 2.8L		UR5	2771			UR5IX	7177	UR5GP	3547	UR5	2771	.045
	V6 4.3L		UR5	2771			UR5IX	7177	UR5GP	3547	UR5	2771	.035
1987-86	L4 2.5L		UR55	2248			UR55IX	7272			UR55	2248	.060
	V6 2.8L		UR5	2771			UR5IX	7177	UR5GP	3547	UR5	2771	.045
1985	L4 1.9L		GR5	2851			GR5IX	7214	GR5GP	3351	GR5	2851	.045



Year	Cyl. L	Notes	Original Equipment		Ruthenium HX		Iridium IX		G-Power		V-Power		Gap
			Part	Stock	Part	Stock	Part	Stock	Part	Stock	Part	Stock	
<b>GMC (Cont'd)</b>													
<b>S15 (Cont'd)</b>													
1985	L4 2.5L		UR55	2248			UR55IX	7272			UR55	2248	.060
	V6 2.8L		UR5	2771			UR5IX	7177	UR5GP	3547	UR5	2771	.045
<b>S15 Jimmy</b>													
1991-90	V6 4.3L		UR5	2771			UR5IX	7177	UR5GP	3547	UR5	2771	.035
1989	V6 2.8L		UR5	2771			UR5IX	7177	UR5GP	3547	UR5	2771	.045
	V6 4.3L		UR5	2771			UR5IX	7177	UR5GP	3547	UR5	2771	.035
1988	L4 2.5L		UR55	2248			UR55IX	7272			UR55	2248	.060
	V6 2.8L		UR5	2771			UR5IX	7177	UR5GP	3547	UR5	2771	.045
	V6 4.3L		UR5	2771			UR5IX	7177	UR5GP	3547	UR5	2771	.035
1987-85	L4 2.5L		UR55	2248			UR55IX	7272			UR55	2248	.060
	V6 2.8L		UR5	2771			UR5IX	7177	UR5GP	3547	UR5	2771	.045
<b>Safari</b>													
2005-03	V6 4.3L		ITR4A15	5599	TR5AHX	94567	TR55IX	7164	TR55GP	3403	TR55	3951	.060
2002-98	V6 4.3L		<b>ITR4A15</b>	<b>5599</b>	TR5AHX	94567	TR55IX	7164	TR55GP	3403	TR55	3951	.060
1997	V6 4.3L		ITR4A15	5599	TR5AHX	94567	TR55IX	7164	TR55GP	3403	TR55	3951	.060
1996	V6 4.3L		ITR4A15	5599			TR55IX	7164	TR55GP	3403	TR55	3951	.060
1995-94	V6 4.3L		UR5	2771			UR5IX	7177	UR5GP	3547	UR5	2771	.045
1993-91	V6 4.3L		UR5	2771			UR5IX	7177	UR5GP	3547	UR5	2771	.035
1990-85	L4 2.5L		UR55	2248			UR55IX	7272			UR55	2248	.060
	V6 4.3L		UR5	2771			UR5IX	7177	UR5GP	3547	UR5	2771	.035
<b>Savana 1500</b>													
2014-07	V6 4.3L		<b>ITR4A15</b>	<b>5599</b>	TR4BHX	97100	TR55IX	7164	TR55GP	3403	TR55	3951	.060
	V8 5.3L		IZTR5B11	1465	TR5AHX	94567	TR5IX	7397	TR5GP	3186	TR5	2238	.040
2006-03	V6 4.3L		<b>ITR4A15</b>	<b>5599</b>	TR5AHX	94567	TR55IX	7164	TR55GP	3403	TR55	3951	.060
	V8 5.3L		IZTR5B11	1465	TR5AHX	94567	TR5IX	7397	TR5GP	3186	TR5	2238	.040
2002-97	V6 4.3L		<b>ITR4A15</b>	<b>5599</b>	TR5AHX	94567	TR55IX	7164	TR55GP	3403	TR55	3951	.060
	V8 5.0L		<b>ITR4A15</b>	<b>5599</b>	TR5AHX	94567	TR55IX	7164	TR55GP	3403	TR55	3951	.060
	V8 5.7L		<b>ITR4A15</b>	<b>5599</b>	TR5AHX	94567	TR55IX	7164	TR55GP	3403	TR55	3951	.060
1996	V6 4.3L		<b>ITR4A15</b>	<b>5599</b>			TR55IX	7164	TR55GP	3403	TR55	3951	.060
	V8 5.0L		<b>ITR4A15</b>	<b>5599</b>			TR55IX	7164	TR55GP	3403	TR55	3951	.060
	V8 5.7L	Vin R, Central SFI(FuelSystDesi.)	<b>ITR4A15</b>	<b>5599</b>			TR55IX	7164	TR55GP	3403	TR55	3951	.060
<b>Savana 2500</b>													
2018	V6 4.3L		ILTR5B11	3474	LTR5AHX	90220	LTR5IX-11	4344	LTR5GP	5019			.044
	V8 6.0L		IZTR5B11	1465	TR5AHX	94567	TR5IX	7397	TR5GP	3186	TR5	2238	.040
2017-12	V8 4.8L		IZTR5B11	1465	TR5AHX	94567	TR5IX	7397	TR5GP	3186	TR5	2238	.040
	V8 6.0L		IZTR5B11	1465	TR5AHX	94567	TR5IX	7397	TR5GP	3186	TR5	2238	.040
2011-07	V8 4.8L		IZTR5B11	1465	TR5AHX	94567	TR5IX	7397	TR5GP	3186	TR5	2238	.040
	V8 6.0L		IZTR5B11	1465	TR5AHX	94567	TR5IX	7397	TR5GP	3186	TR5	2238	.040
	V8 6.6L	DIESEL	Y1033AS	90046									
2006	V6 4.3L		<b>ITR4A15</b>	<b>5599</b>	TR5AHX	94567	TR55IX	7164	TR55GP	3403	TR55	3951	.060
	V8 4.8L		IZTR5B11	1465	TR5AHX	94567	TR5IX	7397	TR5GP	3186	TR5	2238	.040
	V8 6.0L		IZTR5B11	1465	TR5AHX	94567	TR5IX	7397	TR5GP	3186	TR5	2238	.040
	V8 6.6L	DIESEL, w/ Hex Threads Located Middle of Glow Plug	Y1033AS	90046									
	V8 6.6L	DIESEL, w/ Hex Threads Located Near Top of Glow Plug (LLY Engine Only)	Y1032AS	97788									
2005-03	V6 4.3L		<b>ITR4A15</b>	<b>5599</b>	TR5AHX	94567	TR55IX	7164	TR55GP	3403	TR55	3951	.060
	V8 4.8L		IZTR5B11	1465	TR5AHX	94567	TR5IX	7397	TR5GP	3186	TR5	2238	.040
	V8 5.3L		IZTR5B11	1465	TR5AHX	94567	TR5IX	7397	TR5GP	3186	TR5	2238	.040
	V8 6.0L		IZTR5B11	1465	TR5AHX	94567	TR5IX	7397	TR5GP	3186	TR5	2238	.040
2002-97	V6 4.3L		<b>ITR4A15</b>	<b>5599</b>	TR5AHX	94567	TR55IX	7164	TR55GP	3403	TR55	3951	.060
	V8 5.0L		<b>ITR4A15</b>	<b>5599</b>	TR5AHX	94567	TR55IX	7164	TR55GP	3403	TR55	3951	.060
	V8 5.7L		<b>ITR4A15</b>	<b>5599</b>	TR5AHX	94567	TR55IX	7164	TR55GP	3403	TR55	3951	.060
1996	V6 4.3L		<b>ITR4A15</b>	<b>5599</b>		TR55IX	7164	TR55GP	3403	TR55	3951	.060	

**Bold denotes NGK OE Manufacturer and/or OE Service Part**  
NOT BOLD denotes OE Equivalent Part

**Le texte en gras désigne une pièce d'équipement originale du manufacturier NGK et/ou pièce d'équipement originale de service**  
Le texte non en gras désigne une pièce d'équipement originale équivalente

Note: Due to different operating or engine conditions, alternate heat range plugs may be required.

Note: En raison de différences au niveau du fonctionnement ou des conditions du moteur, d'autres types de bougies avec variation de chaleur peuvent être nécessaires



Year	Cyl. L	Notes	Original Equipment		Ruthenium HX		Iridium IX		G-Power		V-Power		Gap
			Part	Stock	Part	Stock	Part	Stock	Part	Stock	Part	Stock	
<b>GMC (Cont'd)</b>													
<b>Savana 2500 (Cont'd)</b>													
1996	V8 5.0L		<b>ITR4A15</b>	<b>5599</b>			TR55IX	7164	TR55GP	3403	TR55	3951	.060
	V8 5.7L	Vin R, Central SFI(FuelSystDesi.)	<b>ITR4A15</b>	<b>5599</b>			TR55IX	7164	TR55GP	3403	TR55	3951	.060
<b>Savana 3500</b>													
2018	V6 4.3L		ILTR5B11	3474	LTR5AHX	90220	LTR5IX-11	4344	LTR5GP	5019			.044
	V8 6.0L		IZTR5B11	1465	TR5AHX	94567	TR5IX	7397	TR5GP	3186	TR5	2238	.040
2017-12	V8 4.8L		IZTR5B11	1465	TR5AHX	94567	TR5IX	7397	TR5GP	3186	TR5	2238	.040
	V8 6.0L		IZTR5B11	1465	TR5AHX	94567	TR5IX	7397	TR5GP	3186	TR5	2238	.040
2011-07	V8 4.8L		IZTR5B11	1465	TR5AHX	94567	TR5IX	7397	TR5GP	3186	TR5	2238	.040
	V8 6.0L		IZTR5B11	1465	TR5AHX	94567	TR5IX	7397	TR5GP	3186	TR5	2238	.040
	V8 6.6L	DIESEL	Y1033AS	90046									
2006	V8 4.8L		IZTR5B11	1465	TR5AHX	94567	TR5IX	7397	TR5GP	3186	TR5	2238	.040
	V8 6.0L		IZTR5B11	1465	TR5AHX	94567	TR5IX	7397	TR5GP	3186	TR5	2238	.040
	V8 6.6L	DIESEL, w/ Hex Threads Located Middle of Glow Plug	Y1033AS	90046									
	V8 6.6L	DIESEL, w/ Hex Threads Located Near Top of Glow Plug (LLY Engine Only)	Y1032AS	97788									
2005-03	V8 4.8L		IZTR5B11	1465	TR5AHX	94567	TR5IX	7397	TR5GP	3186	TR5	2238	.040
	V8 6.0L		IZTR5B11	1465	TR5AHX	94567	TR5IX	7397	TR5GP	3186	TR5	2238	.040
2002-01	V8 5.7L		<b>ITR4A15</b>	<b>5599</b>	TR5AHX	94567	TR55IX	7164	TR55GP	3403	TR55	3951	.060
	V8 8.1L		PZTR5A-15	7862	TR5AHX	94567	TR55IX	7164	TR55GP	3403	TR55	3951	.060
2000-97	V8 5.7L		<b>ITR4A15</b>	<b>5599</b>	TR5AHX	94567	TR55IX	7164	TR55GP	3403	TR55	3951	.060
	V8 7.4L		PTR4G-15	1209	TR5AHX	94567	TR55IX	7164	TR55GP	3403	TR55	3951	.060
1996	V8 5.7L	Vin R, Central SFI(FuelSystDesi.)	<b>ITR4A15</b>	<b>5599</b>			TR55IX	7164	TR55GP	3403	TR55	3951	.060
	V8 7.4L	Vin J, SFI(FuelSystDesi.)	PTR4G-15	1209			TR55IX	7164	TR55GP	3403	TR55	3951	.060
<b>Savana 4500</b>													
2016-12	V8 6.0L		IZTR5B11	1465	TR5AHX	94567	TR5IX	7397	TR5GP	3186	TR5	2238	.040
2011-09	V8 6.0L		IZTR5B11	1465	TR5AHX	94567	TR5IX	7397	TR5GP	3186	TR5	2238	.040
	V8 6.6L	DIESEL	Y1033AS	90046									
<b>Sierra 1500</b>													
2018-14	V6 4.3L		ILTR5B11	3474	LTR5AHX	90220	LTR5IX-11	4344	LTR5GP	5019			.044
	V8 5.3L		ILTR5B11	3474	LTR5AHX	90220	LTR5IX-11	4344	LTR5GP	5019			.044
	V8 6.2L		ILTR5B11	3474	LTR5AHX	90220	LTR5IX-11	4344	LTR5GP	5019			.044
2013-07	V6 4.3L		<b>ITR4A15</b>	<b>5599</b>	TR4BHX	97100	TR55IX	7164	TR55GP	3403	TR55	3951	.060
	V8 4.8L		IZTR5B11	1465	TR5AHX	94567	TR5IX	7397	TR5GP	3186	TR5	2238	.040
	V8 5.3L		IZTR5B11	1465	TR5AHX	94567	TR5IX	7397	TR5GP	3186	TR5	2238	.040
	V8 6.0L		IZTR5B11	1465	TR5AHX	94567	TR5IX	7397	TR5GP	3186	TR5	2238	.040
	V8 6.2L		IZTR5B11	1465	TR5AHX	94567	TR5IX	7397	TR5GP	3186	TR5	2238	.040
2006-01	V6 4.3L		<b>ITR4A15</b>	<b>5599</b>	TR5AHX	94567	TR55IX	7164	TR55GP	3403	TR55	3951	.060
	V8 4.8L		IZTR5B11	1465	TR5AHX	94567	TR5IX	7397	TR5GP	3186	TR5	2238	.040
	V8 5.3L		IZTR5B11	1465	TR5AHX	94567	TR5IX	7397	TR5GP	3186	TR5	2238	.040
	V8 6.0L		IZTR5B11	1465	TR5AHX	94567	TR5IX	7397	TR5GP	3186	TR5	2238	.040
2000-99	V6 4.3L		<b>ITR4A15</b>	<b>5599</b>	TR5AHX	94567	TR55IX	7164	TR55GP	3403	TR55	3951	.060
	V8 4.8L		IZTR5B11	1465	TR5AHX	94567	TR5IX	7397	TR5GP	3186	TR5	2238	.040
	V8 5.3L		IZTR5B11	1465	TR5AHX	94567	TR5IX	7397	TR5GP	3186	TR5	2238	.040
<b>Sierra 1500 Classic</b>													
2007	V6 4.3L		<b>ITR4A15</b>	<b>5599</b>	TR5AHX	94567	TR55IX	7164	TR55GP	3403	TR55	3951	.060
	V8 4.8L		IZTR5B11	1465	TR5AHX	94567	TR5IX	7397	TR5GP	3186	TR5	2238	.040
	V8 5.3L		IZTR5B11	1465	TR5AHX	94567	TR5IX	7397	TR5GP	3186	TR5	2238	.040
	V8 6.0L		IZTR5B11	1465	TR5AHX	94567	TR5IX	7397	TR5GP	3186	TR5	2238	.040
<b>Sierra 1500 HD</b>													
2006-05	V8 6.0L		IZTR5B11	1465	TR5AHX	94567	TR5IX	7397	TR5GP	3186	TR5	2238	.040
2003-01	V8 6.0L		IZTR5B11	1465	TR5AHX	94567	TR5IX	7397	TR5GP	3186	TR5	2238	.040



Year	Cyl. L	Notes	Original Equipment		Ruthenium HX		Iridium IX		G-Power		V-Power		Gap
			Part	Stock	Part	Stock	Part	Stock	Part	Stock	Part	Stock	
<b>GMC (Cont'd)</b>													
Sierra 1500 HD Classic													
2007	V8 6.0L		IZTR5B11	1465	TR5AHX	94567	TR5IX	7397	TR5GP	3186	TR5	2238	.040
Sierra 2500													
2004-01	V8 6.0L		IZTR5B11	1465	TR5AHX	94567	TR5IX	7397	TR5GP	3186	TR5	2238	.040
2000-99	V8 5.3L		IZTR5B11	1465	TR5AHX	94567	TR5IX	7397	TR5GP	3186	TR5	2238	.040
	V8 6.0L		IZTR5B11	1465	TR5AHX	94567	TR5IX	7397	TR5GP	3186	TR5	2238	.040
Sierra 2500 HD													
2018-12	V8 6.0L		IZTR5B11	1465	TR5AHX	94567	TR5IX	7397	TR5GP	3186	TR5	2238	.040
2011-07	V8 6.0L		IZTR5B11	1465	TR5AHX	94567	TR5IX	7397	TR5GP	3186	TR5	2238	.040
	V8 6.6L	DIESEL	Y1033AS	90046									
2006	V8 6.0L		IZTR5B11	1465	TR5AHX	94567	TR5IX	7397	TR5GP	3186	TR5	2238	.040
	V8 6.6L	Vin 2, DIESEL, w/ Hex Threads Located Middle of Glow Plug	Y1033AS	90046									
	V8 6.6L	Vin 2, DIESEL, w/ Hex Threads Located Near Top of Glow Plug (LLY Engine Only)	Y1032AS	97788									
	V8 6.6L	Vin D, DIESEL	Y1033AS	90046									
	V8 8.1L		PZTR5A-15	7862	TR5AHX	94567	TR55IX	7164	TR55GP	3403	TR55	3951	.060
2005	V8 6.0L		IZTR5B11	1465	TR5AHX	94567	TR5IX	7397	TR5GP	3186	TR5	2238	.040
	V8 6.6L	DIESEL	Y1032AS	97788									
	V8 8.1L		PZTR5A-15	7862	TR5AHX	94567	TR55IX	7164	TR55GP	3403	TR55	3951	.060
2004	V8 6.0L		IZTR5B11	1465	TR5AHX	94567	TR5IX	7397	TR5GP	3186	TR5	2238	.040
	V8 6.6L	Vin 2, DIESEL	Y1032AS	97788									
	V8 8.1L		PZTR5A-15	7862	TR5AHX	94567	TR55IX	7164	TR55GP	3403	TR55	3951	.060
2003	V8 6.0L		IZTR5B11	1465	TR5AHX	94567	TR5IX	7397	TR5GP	3186	TR5	2238	.040
	V8 8.1L		PZTR5A-15	7862	TR5AHX	94567	TR55IX	7164	TR55GP	3403	TR55	3951	.060
2002-01	V8 6.0L		IZTR5B11	1465	TR5AHX	94567	TR5IX	7397	TR5GP	3186	TR5	2238	.040
	V8 8.1L		<b>PZTR5A-15</b>	<b>7862</b>	TR5AHX	94567	TR55IX	7164	TR55GP	3403	TR55	3951	.060
Sierra 2500 HD Classic													
2007	V8 6.0L		IZTR5B11	1465	TR5AHX	94567	TR5IX	7397	TR5GP	3186	TR5	2238	.040
	V8 8.1L		PZTR5A-15	7862	TR5AHX	94567	TR55IX	7164	TR55GP	3403	TR55	3951	.060
Sierra 3500													
2006	V8 6.0L		IZTR5B11	1465	TR5AHX	94567	TR5IX	7397	TR5GP	3186	TR5	2238	.040
	V8 6.6L	Vin 2, DIESEL, w/ Hex Threads Located Middle of Glow Plug	Y1033AS	90046									
	V8 6.6L	Vin 2, DIESEL, w/ Hex Threads Located Near Top of Glow Plug (LLY Engine Only)	Y1032AS	97788									
	V8 6.6L	Vin D, DIESEL	Y1033AS	90046									
	V8 8.1L		PZTR5A-15	7862	TR5AHX	94567	TR55IX	7164	TR55GP	3403	TR55	3951	.060
2005	V8 6.0L		IZTR5B11	1465	TR5AHX	94567	TR5IX	7397	TR5GP	3186	TR5	2238	.040
	V8 6.6L	DIESEL	Y1032AS	97788									
	V8 8.1L		PZTR5A-15	7862	TR5AHX	94567	TR55IX	7164	TR55GP	3403	TR55	3951	.060
2004	V8 6.0L		IZTR5B11	1465	TR5AHX	94567	TR5IX	7397	TR5GP	3186	TR5	2238	.040
	V8 6.6L	Vin 2, DIESEL	Y1032AS	97788									
	V8 8.1L		PZTR5A-15	7862	TR5AHX	94567	TR55IX	7164	TR55GP	3403	TR55	3951	.060
2003	V8 6.0L		IZTR5B11	1465	TR5AHX	94567	TR5IX	7397	TR5GP	3186	TR5	2238	.040
	V8 8.1L		PZTR5A-15	7862	TR5AHX	94567	TR55IX	7164	TR55GP	3403	TR55	3951	.060
2002-01	V8 6.0L		IZTR5B11	1465	TR5AHX	94567	TR5IX	7397	TR5GP	3186	TR5	2238	.040
	V8 8.1L		<b>PZTR5A-15</b>	<b>7862</b>	TR5AHX	94567	TR55IX	7164	TR55GP	3403	TR55	3951	.060
Sierra 3500 Classic													
2007	V8 6.0L		IZTR5B11	1465	TR5AHX	94567	TR5IX	7397	TR5GP	3186	TR5	2238	.040
	V8 6.6L	DIESEL	Y1033AS	90046									
	V8 8.1L		PZTR5A-15	7862	TR5AHX	94567	TR55IX	7164	TR55GP	3403	TR55	3951	.060
Sierra 3500 HD													
2018-12	V8 6.0L		IZTR5B11	1465	TR5AHX	94567	TR5IX	7397	TR5GP	3186	TR5	2238	.040

**Bold denotes NGK OE Manufacturer and/or OE Service Part**  
NOT BOLD denotes OE Equivalent Part

Note: Due to different operating or engine conditions, alternate heat range plugs may be required.

**Le texte en gras désigne une pièce d'équipement originale du manufacturier NGK et/ou pièce d'équipement originale de service**  
Le texte non en gras désigne une pièce d'équipement originale équivalente

Note: En raison de différences au niveau du fonctionnement ou des conditions du moteur, d'autres types de bougies avec variation de chaleur peuvent être nécessaires



Year	Cyl. L	Notes	Original Equipment		Ruthenium HX		Iridium IX		G-Power		V-Power		Gap
			Part	Stock	Part	Stock	Part	Stock	Part	Stock	Part	Stock	
<b>GMC (Cont'd)</b>													
Sierra 3500 HD (Cont'd)													
2011-07	V8 6.0L		IZTR5B11	1465	TR5AHX	94567	TR5IX	7397	TR5GP	3186	TR5	2238	.040
	V8 6.6L	DIESEL	Y1033AS	90046									
Sonoma													
2004	V6 4.3L		<b>ITR4A15</b>	<b>5599</b>	TR5AHX	94567	TR55IX	7164	TR55GP	3403	TR55	3951	.060
2003-98	L4 2.2L		PTR5D-10	3784			TR5IX	7397	TR5GP	3186	TR5	2238	.040
	V6 4.3L		<b>ITR4A15</b>	<b>5599</b>	TR5AHX	94567	TR55IX	7164	TR55GP	3403	TR55	3951	.060
1997-96	L4 2.2L		PZTR5A-15	7862			TR55-1IX	7316	TR55-1GP	7159	TR55-1	2683	.060
	V6 4.3L		<b>ITR4A15</b>	<b>5599</b>	TR5AHX	94567	TR55IX	7164	TR55GP	3403	TR55	3951	.060
1995-94	L4 2.2L		PZTR5A-15	7862			TR55-1IX	7316	TR55-1GP	7159	TR55-1	2683	.060
	V6 4.3L		UR5	2771			UR5IX	7177	UR5GP	3547	UR5	2771	.045
1993-91	L4 2.5L		UR55	2248			UR55IX	7272			UR55	2248	.060
	V6 2.8L		UR5	2771			UR5IX	7177	UR5GP	3547	UR5	2771	.045
	V6 4.3L		UR5	2771			UR5IX	7177	UR5GP	3547	UR5	2771	.035
Syclone													
1991	V6 4.3L		UR5	2771			UR5IX	7177	UR5GP	3547	UR5	2771	.035
Terrain													
2018	L4 1.5L		ILNAR8B7G	91970									.028
	L4 2.0L		<b>ILTR6M9G</b>	<b>94489</b>	LTR6BHX	90495							.036
2017-13	L4 2.4L		<b>ILTR5D</b>	<b>5476</b>	LTR5AHX	90220	LTR5IX-11	4344	LTR5GP	5019			.036
	V6 3.6L		<b>ILTR6E11</b>	<b>90117</b>	LTR6AHX	91276	LTR6IX-11	6509	LTR6GP	90198			.044
2012-10	L4 2.4L		<b>ILTR5D</b>	<b>5476</b>	LTR5AHX	90220	LTR5IX-11	4344	LTR5GP	5019			.036
	V6 3.0L		<b>ILTR6E11</b>	<b>90117</b>	LTR6AHX	91276	LTR6IX-11	6509	LTR6GP	90198			.044
Tracker													
1991-89	L4 1.6L		<b>BKR6E-11</b>	<b>2756</b>			BKR6EIX-11	3764	BKR6EGP	7092	BKR6E-11	2756	.042
Typhoon													
1993-92	V6 4.3L		UR5	2771			UR5IX	7177	UR5GP	3547	UR5	2771	.035
V1500													
1987	V6 4.3L		UR5	2771			UR5IX	7177	UR5GP	3547	UR5	2771	.035
	V8 5.0L		UR5	2771			UR5IX	7177	UR5GP	3547	UR5	2771	.035
	V8 5.7L		UR5	2771			UR5IX	7177	UR5GP	3547	UR5	2771	.035
V1500 Suburban													
1991-87	V8 5.7L		UR5	2771			UR5IX	7177	UR5GP	3547	UR5	2771	.035
V2500													
1987	L6 4.8L		YR5	7052			YR5IX	7516	YR5GP	2953	YR5	7052	.035
	V8 5.7L		UR5	2771			UR5IX	7177	UR5GP	3547	UR5	2771	.035
V2500 Suburban													
1991-87	V8 5.7L		UR5	2771			UR5IX	7177	UR5GP	3547	UR5	2771	.035
V3500													
1991-90	V8 5.7L		UR5	2771			UR5IX	7177	UR5GP	3547	UR5	2771	.035
	V8 7.4L		UR5	2771			UR5IX	7177	UR5GP	3547	UR5	2771	.035
1989	V8 5.7L		UR5	2771			UR5IX	7177	UR5GP	3547	UR5	2771	.035
	V8 7.4L	CARB	YR5	7052			YR5IX	7516	YR5GP	2953	YR5	7052	.045
		FI	UR5	2771			UR5IX	7177	UR5GP	3547	UR5	2771	.035
1988	L6 4.8L		YR5	7052			YR5IX	7516	YR5GP	2953	YR5	7052	.035
	V8 5.7L	CARB	YR5	7052			YR5IX	7516	YR5GP	2953	YR5	7052	.035
		FI	UR5	2771			UR5IX	7177	UR5GP	3547	UR5	2771	.035
	V8 7.4L	CARB	YR5	7052			YR5IX	7516	YR5GP	2953	YR5	7052	.045
		FI	UR5	2771			UR5IX	7177	UR5GP	3547	UR5	2771	.035
1987	L6 4.8L		YR5	7052			YR5IX	7516	YR5GP	2953	YR5	7052	.035
	V8 5.7L	CARB	YR5	7052			YR5IX	7516	YR5GP	2953	YR5	7052	.045
		FI	UR5	2771			UR5IX	7177	UR5GP	3547	UR5	2771	.035
	V8 7.4L	CARB	YR5	7052			YR5IX	7516	YR5GP	2953	YR5	7052	.035
		FI	UR5	2771			UR5IX	7177	UR5GP	3547	UR5	2771	.035
Yukon													
2018-15	V8 5.3L		ILTR5B11	3474	LTR5AHX	90220	LTR5IX-11	4344	LTR5GP	5019			.044
	V8 6.2L		ILTR5B11	3474	LTR5AHX	90220	LTR5IX-11	4344	LTR5GP	5019			.044
2014	V8 5.3L		IZTR5B11	1465	TR5AHX	94567	TR5IX	7397	TR5GP	3186	TR5	2238	.040





Year	Cyl. L	Notes	Original Equipment		Ruthenium HX		Iridium IX		G-Power		V-Power		Gap
			Part	Stock	Part	Stock	Part	Stock	Part	Stock	Part	Stock	
<b>GMC (Cont'd)</b>													
<b>Yukon (Cont'd)</b>													
2014	V8 6.2L		IZTR5B11	1465	TR5AHX	94567	TR5IX	7397	TR5GP	3186	TR5	2238	.040
2013-10	V8 5.3L		IZTR5B11	1465	TR5AHX	94567	TR5IX	7397	TR5GP	3186	TR5	2238	.040
	V8 6.0L		IZTR5B11	1465	TR5AHX	94567	TR5IX	7397	TR5GP	3186	TR5	2238	.040
	V8 6.2L		IZTR5B11	1465	TR5AHX	94567	TR5IX	7397	TR5GP	3186	TR5	2238	.040
2009-08	V8 4.8L		IZTR5B11	1465	TR5AHX	94567	TR5IX	7397	TR5GP	3186	TR5	2238	.040
	V8 5.3L		IZTR5B11	1465	TR5AHX	94567	TR5IX	7397	TR5GP	3186	TR5	2238	.040
	V8 6.0L		IZTR5B11	1465	TR5AHX	94567	TR5IX	7397	TR5GP	3186	TR5	2238	.040
	V8 6.2L		IZTR5B11	1465	TR5AHX	94567	TR5IX	7397	TR5GP	3186	TR5	2238	.040
2007	V8 4.8L		IZTR5B11	1465	TR5AHX	94567	TR5IX	7397	TR5GP	3186	TR5	2238	.040
	V8 5.3L		IZTR5B11	1465	TR5AHX	94567	TR5IX	7397	TR5GP	3186	TR5	2238	.040
	V8 6.2L		IZTR5B11	1465	TR5AHX	94567	TR5IX	7397	TR5GP	3186	TR5	2238	.040
2006-01	V8 4.8L		PTR5D-10	3784	TR5AHX	94567	TR5IX	7397	TR5GP	3186	TR5	2238	.040
	V8 5.3L		PTR5D-10	3784	TR5AHX	94567	TR5IX	7397	TR5GP	3186	TR5	2238	.040
	V8 6.0L		IZTR5B11	1465	TR5AHX	94567	TR5IX	7397	TR5GP	3186	TR5	2238	.040
2000	V8 4.8L		PTR5D-10	3784	TR5AHX	94567	TR5IX	7397	TR5GP	3186	TR5	2238	.040
	V8 5.3L		PTR5D-10	3784	TR5AHX	94567	TR5IX	7397	TR5GP	3186	TR5	2238	.040
	V8 5.7L		<b>ITR4A15</b>	<b>5599</b>	TR5AHX	94567	TR55IX	7164	TR55GP	3403	TR55	3951	.060
1999-97	V8 5.7L		<b>ITR4A15</b>	<b>5599</b>	TR5AHX	94567	TR55IX	7164	TR55GP	3403	TR55	3951	.060
1996	V8 5.7L		<b>ITR4A15</b>	<b>5599</b>			TR55IX	7164	TR55GP	3403	TR55	3951	.060
1995-92	V8 5.7L		UR5	2771			UR5IX	7177	UR5GP	3547	UR5	2771	.035
<b>Yukon XL</b>													
2018-15	V8 5.3L		ILTR5B11	3474	LTR5AHX	90220	LTR5IX-11	4344	LTR5GP	5019			.044
	V8 6.2L		ILTR5B11	3474	LTR5AHX	90220	LTR5IX-11	4344	LTR5GP	5019			.044
<b>Yukon XL 1500</b>													
2014-10	V8 5.3L		IZTR5B11	1465	TR5AHX	94567	TR5IX	7397	TR5GP	3186	TR5	2238	.040
	V8 6.2L		IZTR5B11	1465	TR5AHX	94567	TR5IX	7397	TR5GP	3186	TR5	2238	.040
2009-07	V8 5.3L		IZTR5B11	1465	TR5AHX	94567	TR5IX	7397	TR5GP	3186	TR5	2238	.040
	V8 6.0L		IZTR5B11	1465	TR5AHX	94567	TR5IX	7397	TR5GP	3186	TR5	2238	.040
	V8 6.2L		IZTR5B11	1465	TR5AHX	94567	TR5IX	7397	TR5GP	3186	TR5	2238	.040
2006-01	V8 5.3L		PTR5D-10	3784	TR5AHX	94567	TR5IX	7397	TR5GP	3186	TR5	2238	.040
	V8 6.0L		IZTR5B11	1465	TR5AHX	94567	TR5IX	7397	TR5GP	3186	TR5	2238	.040
2000	V8 5.3L		PTR5D-10	3784	TR5AHX	94567	TR5IX	7397	TR5GP	3186	TR5	2238	.040
<b>Yukon XL 2500</b>													
2013-07	V8 6.0L		IZTR5B11	1465	TR5AHX	94567	TR5IX	7397	TR5GP	3186	TR5	2238	.040
2006	V8 6.0L		IZTR5B11	1465	TR5AHX	94567	TR5IX	7397	TR5GP	3186	TR5	2238	.040
	V8 8.1L		<b>PZTR5A-15</b>	<b>7862</b>	TR5AHX	94567	TR55IX	7164	TR55GP	3403	TR55	3951	.060
2005	V8 6.0L		IZTR5B11	1465	TR5AHX	94567	TR5IX	7397	TR5GP	3186	TR5	2238	.040
	V8 8.1L		<b>PZTR5A-15</b>	<b>7862</b>	TR5AHX	94567	TR55IX	7164	TR55GP	3403	TR55	3951	.060
2004	V8 6.0L		IZTR5B11	1465	TR5AHX	94567	TR5IX	7397	TR5GP	3186	TR5	2238	.040
	V8 8.1L		<b>PZTR5A-15</b>	<b>7862</b>	TR5AHX	94567	TR55IX	7164	TR55GP	3403	TR55	3951	.060
2003-01	V8 6.0L		IZTR5B11	1465	TR5AHX	94567	TR5IX	7397	TR5GP	3186	TR5	2238	.040
	V8 8.1L		<b>PZTR5A-15</b>	<b>7862</b>	TR5AHX	94567	TR55IX	7164	TR55GP	3403	TR55	3951	.060
2000	V8 6.0L		IZTR5B11	1465	TR5AHX	94567	TR5IX	7397	TR5GP	3186	TR5	2238	.040
<b>HONDA</b>													
<b>Accord</b>													
2017	L4 2.0L		<b>ILZKAR7E11S</b>	<b>96509</b>	LKAR7AHX-S	92274	LKAR7BIX-11S	93501	LKAR7BGP-S	92649			.044
	L4 2.4L		<b>DILKAR7G11GS</b>	<b>91578</b>	LKAR7AHX-S	92274	LKAR7BIX-11S	93501	LKAR7BGP-S	92649			.044
	V6 3.5L		<b>ILZKR7B11</b>	<b>7751</b>	LKR7AHX-S	96358	LKR7DIX-11S	93175	LKR7BGP-S	97390			.044
2016	L4 2.4L		<b>DILKAR7G11GS</b>	<b>91578</b>	LKAR7AHX-S	92274	LKAR7BIX-11S	93501	LKAR7BGP-S	92649			.044
	V6 3.5L		<b>ILZKR7B11</b>	<b>7751</b>	LKR7AHX-S	96358	LKR7DIX-11S	93175	LKR7BGP-S	97390			.044
2015-14	L4 2.0L		<b>ILZKAR7E11S</b>	<b>96509</b>	LKAR7AHX-S	92274	LKAR7BIX-11S	93501	LKAR7BGP-S	92649			.044
	L4 2.4L		<b>DILKAR7G11GS</b>	<b>91578</b>	LKAR7AHX-S	92274	LKAR7BIX-11S	93501	LKAR7BGP-S	92649			.044
	V6 3.5L		<b>ILZKR7B11</b>	<b>7751</b>	LKR7AHX-S	96358	LKR7DIX-11S	93175	LKR7BGP-S	97390			.044
2013	L4 2.4L		<b>DILKAR7G11GS</b>	<b>91578</b>	LKAR7AHX-S	92274	LKAR7BIX-11S	93501	LKAR7BGP-S	92649			.044
	V6 3.5L		<b>ILZKR7B11</b>	<b>7751</b>	LKR7AHX-S	96358	LKR7DIX-11S	93175	LKR7BGP-S	97390			.044
2012-10	L4 2.4L	w/o PZEV (Federal Emissions)	<b>ILZKR7B-11S</b>	<b>5787</b>	LKR7AHX-S	96358	LKR7DIX-11S	93175	LKR7BGP-S	97390			.044

**Bold denotes NGK OE Manufacturer and/or OE Service Part**  
NOT BOLD denotes OE Equivalent Part

Note: Due to different operating or engine conditions, alternate heat range plugs may be required.

161

**Le texte en gras désigne une pièce d'équipement originale du manufacturier NGK et/ou pièce d'équipement originale de service**  
Le texte non en gras désigne une pièce d'équipement originale équivalente

Note: En raison de différences au niveau du fonctionnement ou des conditions du moteur, d'autres types de bougies avec variation de chaleur peuvent être nécessaires



Year	Cyl. L	Notes	Original Equipment		Ruthenium HX		Iridium IX		G-Power		V-Power		Gap
			Part	Stock	Part	Stock	Part	Stock	Part	Stock	Part	Stock	
<b>HONDA (Cont'd)</b>													
<b>Accord (Cont'd)</b>													
2012-10		w/PZEV (California Emissions)	<b>DILZKR7B11GS</b>	<b>95710</b>	LKR7AHX-S	96358	LKR7DIX-11S	93175	LKR7BGP-S	97390			.044
	V6 3.5L		<b>ILZKR7B11</b>	<b>7751</b>	LKR7AHX-S	96358	LKR7DIX-11S	93175	LKR7BGP-S	97390			.044
2009-08	L4 2.4L	w/o PZEV (Federal Emissions)	<b>ILZKR7B-11S</b>	<b>5787</b>	LKR7AHX-S	96358	LKR7DIX-11S	93175	LKR7BGP-S	97390			.044
		w/PZEV (California Emissions)	<b>DILZKR7B11GS</b>	<b>95710</b>	LKR7AHX-S	96358	LKR7DIX-11S	93175	LKR7BGP-S	97390			.044
	V6 3.5L	w/o PZEV (Federal Emissions)	<b>ILZKR7B11</b>	<b>7751</b>	LKR7AHX-S	96358	LKR7DIX-11S	93175	LKR7BGP-S	97390			.044
		w/PZEV (California Emissions)	<b>DILZKR7A11G</b>	<b>92924</b>	LKR7AHX-S	96358	LKR7DIX-11S	93175	LKR7BGP-S	97390			.044
2007-03	L4 2.4L	w/o SULEV (Federal Emissions)	<b>IZFR6K11</b>	<b>6994</b>	FR6AHX-S	94279	ZFR6AIX-11S	97138	ZFR6BGP-S	92213			.044
		w/SULEV (California Emissions)	<b>IZFR6K13</b>	<b>6774</b>	FR6AHX-S	94279	ZFR6AIX-11S	97138	ZFR6BGP-S	92213			.052
	V6 3.0L	w/o SULEV (Federal Emissions)	<b>IZFR6K11</b>	<b>6994</b>	FR6AHX-S	94279	ZFR6AIX-11S	97138	ZFR6BGP-S	92213			.044
		w/SULEV (California Emissions)	<b>IZFR6K13</b>	<b>6774</b>	FR6AHX-S	94279	ZFR6AIX-11S	97138	ZFR6BGP-S	92213			.052
2002-00	L4 2.3L		<b>PZFR5F-11</b>	<b>4363</b>	FR5AHX	95839	ZFR5FIX-11	2477	ZFR5FGP	7098	ZFR5F-11	2262	.044
	V6 3.0L		<b>PZFR5F-11</b>	<b>4363</b>	FR5AHX	95839	ZFR5FIX-11	2477	ZFR5FGP	7098	ZFR5F-11	2262	.044
1999-98	L4 2.3L		<b>ZFR5F-11</b>	<b>2262</b>	FR5AHX	95839	ZFR5FIX-11	2477	ZFR5FGP	7098	ZFR5F-11	2262	.044
	V6 3.0L		<b>PZFR5F-11</b>	<b>4363</b>	FR5AHX	95839	ZFR5FIX-11	2477	ZFR5FGP	7098	ZFR5F-11	2262	.044
1997	L4 2.2L		<b>ZFR5F-11</b>	<b>2262</b>	FR5AHX	95839	ZFR5FIX-11	2477	ZFR5FGP	7098	ZFR5F-11	2262	.044
	V6 2.7L		<b>ZFR5F-11</b>	<b>2262</b>	FR5AHX	95839	ZFR5FIX-11	2477	ZFR5FGP	7098	ZFR5F-11	2262	.044
1996-95	L4 2.2L		<b>ZFR5F-11</b>	<b>2262</b>			ZFR5FIX-11	2477	ZFR5FGP	7098	ZFR5F-11	2262	.044
	V6 2.7L		<b>ZFR5F-11</b>	<b>2262</b>			ZFR5FIX-11	2477	ZFR5FGP	7098	ZFR5F-11	2262	.044
1994-90	L4 2.2L		<b>ZFR5F-11</b>	<b>2262</b>			ZFR5FIX-11	2477	ZFR5FGP	7098	ZFR5F-11	2262	.044
1989-86	L4 2.0L		<b>BPR5EY-11</b>	<b>6937</b>			BPR5EIX-11	2115	BPR5EGP	7082	BPR5EY-11	6937	.044
1985	L4 1.8L	CARB	<b>BUR5EB-11</b>	<b>6735</b>									.044
		FI	<b>BPR6EY-11</b>	<b>6261</b>			BPR6EIX-11	3903	BPR6EGP	7084	BPR6EY-11	6261	.044
<b>Accord Crosstour</b>													
2011-10	V6 3.5L		<b>ILZKR7B11</b>	<b>7751</b>	LKR7AHX-S	96358	LKR7DIX-11S	93175	LKR7BGP-S	97390			.044
<b>Civic</b>													
2018-17	L4 1.5L	Eng Desg L15B7	<b>ILZKAR8H8S</b>	<b>95112</b>									.032
		Eng Desg L15BA	<b>ILZKAR8J8SY</b>	<b>95660</b>									.030
	L4 2.0L	Naturally Aspirated	<b>DILKAR7G11GS</b>	<b>91578</b>	LKAR7AHX-S	92274	LKAR7BIX-11S	93501	LKAR7BGP-S	92649			.044
		Turbo	<b>ILZKAR8H8S</b>	<b>95112</b>									.032
2016	L4 1.5L		<b>ILZKAR8H8S</b>	<b>95112</b>									.032
	L4 2.0L		<b>DILKAR7G11GS</b>	<b>91578</b>	LKAR7AHX-S	92274	LKAR7BIX-11S	93501	LKAR7BGP-S	92649			.044
2015-12	L4 1.5L	Dual Plug; 8 Req'd	<b>DILFR6J11</b>	<b>92491</b>	LFR6AHX-S	94122	LFR6AIX-11	6619	LFR6CGP	1483			.044
	L4 1.8L	CNG	<b>SILKR8B8DS</b>	<b>95705</b>	LKR8BHX-S	90465							.032
		GAS	<b>DILZKR7B11GS</b>	<b>95710</b>	LKR7AHX-S	96358	LKR7DIX-11S	93175	LKR7BGP-S	97390			.044
	L4 2.4L		<b>ILZKR7B-11S</b>	<b>5787</b>	LKR7AHX-S	96358	LKR7DIX-11S	93175	LKR7BGP-S	97390			.044
2011-06	L4 1.3L	Dual Plug; 8 Req'd	<b>ILFR6J-11K</b>	<b>4458</b>	LFR6AHX-S	94122	LFR6AIX-11	6619	LFR6CGP	1483	LFR6C-11	7787	.044
	L4 1.8L	CNG	<b>IFR7F-8DS</b>	<b>5794</b>	FR7BHX-S	92400							.032
		GAS	<b>IZFR6K-11S</b>	<b>5266</b>	FR6AHX-S	94279	ZFR6AIX-11S	97138	ZFR6BGP-S	92213			.044
	L4 2.0L		<b>IFR7G-11KS</b>	<b>7746</b>	FR7BHX-S	92400							.044
2005-03	L4 1.3L	Dual Plug; 8 Req'd	<b>IFR5G-11K</b>	<b>3107</b>	FR5AHX	95839	BKR5EIX-11	5464	BKR5EGP	7090	BKR5E-11	6953	.044
	L4 1.7L	CNG	<b>PFR7N8DS</b>	<b>93580</b>	FR7BHX-S	92400							.032
		GAS	<b>PZFR6F-11</b>	<b>3271</b>	FR6AHX-S	94279	ZFR6FIX-11	6441	ZFR6FGP	7100	ZFR6F-11	4291	.044
	L4 2.0L		<b>IZFR6K11</b>	<b>6994</b>	FR6AHX-S	94279	ZFR6AIX-11S	97138	ZFR6BGP-S	92213			.044
2002	L4 1.7L	CNG	<b>PFR7N8DS</b>	<b>93580</b>	FR7BHX-S	92400							.032
		GAS	<b>PZFR6F-11</b>	<b>3271</b>	FR6AHX-S	94279	ZFR6FIX-11	6441	ZFR6FGP	7100	ZFR6F-11	4291	.044
	L4 2.0L		<b>IZFR6K11</b>	<b>6994</b>	FR6AHX-S	94279	ZFR6AIX-11S	97138	ZFR6BGP-S	92213			.044
2001	L4 1.7L	CNG	<b>PFR7N8DS</b>	<b>93580</b>	FR7BHX-S	92400							.032
		GAS	<b>PZFR6F-11</b>	<b>3271</b>	FR6AHX-S	94279	ZFR6FIX-11	6441	ZFR6FGP	7100	ZFR6F-11	4291	.044
2000-99	L4 1.6L	CNG, Eng Desg D16B5	<b>PFR7N8DS</b>	<b>93580</b>	FR7BHX-S	92400							.032
		GAS, Eng Desg B16A2	<b>PFR6L-13</b>	<b>3141</b>	FR6AHX-S	94279	BKR6EIX-11	3764	BKR6EGP	7092	BKR6E-11	2756	.052



Year	Cyl. L	Notes	Original Equipment		Ruthenium HX		Iridium IX		G-Power		V-Power		Gap
			Part	Stock	Part	Stock	Part	Stock	Part	Stock	Part	Stock	
<b>HONDA (Cont'd)</b>													
<b>Civic (Cont'd)</b>													
2000-99		GAS, Eng Desg D16Y5	<b>ZFR4F-11</b>	<b>4043</b>							ZFR4F-11	4043	.044
		GAS, Eng Desg D16Y7	<b>ZFR5F-11</b>	<b>2262</b>	FR5AHX	95839	ZFR5FIX-11	2477	ZFR5FGP	7098	ZFR5F-11	2262	.044
		GAS, Eng Desg D16Y8	<b>ZFR5F-11</b>	<b>2262</b>	FR5AHX	95839	ZFR5FIX-11	2477	ZFR5FGP	7098	ZFR5F-11	2262	.044
1998	L4 1.6L	CNG, Eng Desg D16B5	<b>PFR7N8DS</b>	<b>93580</b>	FR7BHX-S	92400							.032
		GAS, Eng Desg D16Y5	<b>ZFR4F-11</b>	<b>4043</b>							ZFR4F-11	4043	.044
		GAS, Eng Desg D16Y7	<b>ZFR5F-11</b>	<b>2262</b>	FR5AHX	95839	ZFR5FIX-11	2477	ZFR5FGP	7098	ZFR5F-11	2262	.044
		GAS, Eng Desg D16Y8	<b>ZFR5F-11</b>	<b>2262</b>	FR5AHX	95839	ZFR5FIX-11	2477	ZFR5FGP	7098	ZFR5F-11	2262	.044
1997	L4 1.6L	Eng Desg D16Y5	<b>ZFR4F-11</b>	<b>4043</b>							ZFR4F-11	4043	.044
		Eng Desg D16Y7	<b>ZFR5F-11</b>	<b>2262</b>	FR5AHX	95839	ZFR5FIX-11	2477	ZFR5FGP	7098	ZFR5F-11	2262	.044
		Eng Desg D16Y8	<b>ZFR5F-11</b>	<b>2262</b>	FR5AHX	95839	ZFR5FIX-11	2477	ZFR5FGP	7098	ZFR5F-11	2262	.044
1996	L4 1.6L	Eng Desg D16Y5	<b>ZFR4F-11</b>	<b>4043</b>							ZFR4F-11	4043	.044
		Eng Desg D16Y7	<b>ZFR5F-11</b>	<b>2262</b>			ZFR5FIX-11	2477	ZFR5FGP	7098	ZFR5F-11	2262	.044
		Eng Desg D16Y8	<b>ZFR5F-11</b>	<b>2262</b>			ZFR5FIX-11	2477	ZFR5FGP	7098	ZFR5F-11	2262	.044
1995-92	L4 1.5L	Eng Desg D15B7	<b>ZFR5F-11</b>	<b>2262</b>			ZFR5FIX-11	2477	ZFR5FGP	7098	ZFR5F-11	2262	.044
		Eng Desg D15B8	<b>ZFR4F-11</b>	<b>4043</b>							ZFR4F-11	4043	.044
		Eng Desg D15Z1	<b>ZFR4F-11</b>	<b>4043</b>							ZFR4F-11	4043	.044
	L4 1.6L		<b>ZFR5J-11</b>	<b>5584</b>							ZFR5J-11	5584	.044
1991-88	L4 1.5L		<b>BCPR6E-11</b>	<b>5632</b>			BCPR6EIX-11	4919	BCPR6EGP	7088	BCPR6E-11	5632	.044
	L4 1.6L		<b>BCPR6E-11</b>	<b>5632</b>			BCPR6EIX-11	4919	BCPR6EGP	7088	BCPR6E-11	5632	.044
1987	L4 1.3L	Base	<b>BUR4EB-11</b>	<b>5370</b>									.044
		DX	<b>BUR5EB-11</b>	<b>6735</b>									.044
	L4 1.5L	CARB	<b>BUR4EB-11</b>	<b>5370</b>							BPR6EY-11	6937	.044
		FI	<b>BPR6EY-11</b>	<b>6261</b>			BPR6EIX-11	3903	BPR6EGP	7084	BPR6EY-11	6261	.044
1986	L4 1.3L	Base	<b>BUR4EB-11</b>	<b>5370</b>									.044
		DX	<b>BUR5EB-11</b>	<b>6735</b>									.044
	L4 1.5L	Base, CARB	<b>BUR5EB-11</b>	<b>6735</b>									.044
		CRX, CARB	<b>BUR4EB-11</b>	<b>5370</b>									.044
		CRX HF, CARB	<b>BUR4EB-11</b>	<b>5370</b>									.044
		DX, CARB	<b>BUR4EB-11</b>	<b>5370</b>									.044
	FI	<b>BPR6EY-11</b>	<b>6261</b>			BPR6EIX-11	3903	BPR6EGP	7084	BPR6EY-11	6261	.044	
1985	L4 1.3L	Base	<b>BUR4EB-11</b>	<b>5370</b>									.044
		DX	<b>BUR5EB-11</b>	<b>6735</b>									.044
	L4 1.5L	1500 S	<b>BUR5EB-11</b>	<b>6735</b>									.044
		Base	<b>BUR5EB-11</b>	<b>6735</b>									.044
		CRX	<b>BUR4EB-11</b>	<b>5370</b>									.044
		CRX HF	<b>BUR4EB-11</b>	<b>5370</b>									.044
		CRX Si	<b>BPR6EY-11</b>	<b>6261</b>			BPR6EIX-11	3903	BPR6EGP	7084	BPR6EY-11	6261	.044
		DX	<b>BUR4EB-11</b>	<b>5370</b>									.044
<b>Civic del Sol</b>													
1997	L4 1.6L	Eng Desg B16A2	<b>PFR6L-13</b>	<b>3141</b>	FR6AHX-S	94279	BKR6EIX-11	3764	BKR6EGP	7092	BKR6E-11	2756	.052
		Eng Desg D16Y7	<b>ZFR5F-11</b>	<b>2262</b>	FR5AHX	95839	ZFR5FIX-11	2477	ZFR5FGP	7098	ZFR5F-11	2262	.044
		Eng Desg D16Y8	<b>ZFR5F-11</b>	<b>2262</b>	FR5AHX	95839	ZFR5FIX-11	2477	ZFR5FGP	7098	ZFR5F-11	2262	.044
1996	L4 1.6L	Eng Desg B16A2	<b>PFR6L-13</b>	<b>3141</b>			BKR6EIX-11	3764	BKR6EGP	7092	BKR6E-11	2756	.052
		Eng Desg D16Y7	<b>ZFR5F-11</b>	<b>2262</b>			ZFR5FIX-11	2477	ZFR5FGP	7098	ZFR5F-11	2262	.044
		Eng Desg D16Y8	<b>ZFR5F-11</b>	<b>2262</b>			ZFR5FIX-11	2477	ZFR5FGP	7098	ZFR5F-11	2262	.044
1995-94	L4 1.5L		<b>ZFR5F-11</b>	<b>2262</b>			ZFR5FIX-11	2477	ZFR5FGP	7098	ZFR5F-11	2262	.044
	L4 1.6L	Eng Desg B16A3	<b>PFR6L-13</b>	<b>3141</b>			BKR6EIX-11	3764	BKR6EGP	7092	BKR6E-11	2756	.052
		Eng Desg D16Z6	<b>ZFR5J-11</b>	<b>5584</b>							ZFR5J-11	5584	.044
1993	L4 1.5L		<b>ZFR5F-11</b>	<b>2262</b>			ZFR5FIX-11	2477	ZFR5FGP	7098	ZFR5F-11	2262	.044
	L4 1.6L		<b>ZFR5J-11</b>	<b>5584</b>							ZFR5J-11	5584	.044
<b>Crosstour</b>													
2015-12	L4 2.4L		<b>ILZKR7B-11S</b>	<b>5787</b>	LKR7AHX-S	96358	LKR7DIX-11S	93175	LKR7BGP-S	97390			.044

**Bold denotes NGK OE Manufacturer and/or OE Service Part**  
NOT BOLD denotes OE Equivalent Part

**Le texte en gras désigne une pièce d'équipement originale du manufacturier NGK et/ou pièce d'équipement originale de service**  
Le texte non en gras désigne une pièce d'équipement originale équivalente

Note: Due to different operating or engine conditions, alternate heat range plugs may be required.

Note: En raison de différences au niveau du fonctionnement ou des conditions du moteur, d'autres types de bougies avec variation de chaleur peuvent être nécessaires



Year	Cyl. L	Notes	Original Equipment		Ruthenium HX		Iridium IX		G-Power		V-Power		Gap
			Part	Stock	Part	Stock	Part	Stock	Part	Stock	Part	Stock	
<b>HONDA (Cont'd)</b>													
<b>Crosstour (Cont'd)</b>													
2015-12	V6 3.5L		<b>ILZKR7B11</b>	<b>7751</b>	LKR7AHX-S	96358	LKR7DIX-11S	93175	LKR7BGP-S	97390			.044
<b>CR-V</b>													
2018-17	L4 1.5L		<b>ILZKAR8J8SY</b>	<b>95660</b>									.030
	L4 2.4L		<b>DILKAR7H11GS</b>	<b>96964</b>	LKR7AHX-S	92274							.044
2016-15	L4 2.4L		<b>DILKAR7H11GS</b>	<b>96964</b>	LKR7AHX-S	92274							.044
2014-10	L4 2.4L		<b>ILZKR7B-11S</b>	<b>5787</b>	LKR7AHX-S	96358	LKR7DIX-11S	93175	LKR7BGP-S	97390			.044
2009-02	L4 2.4L		<b>IZFR6K11</b>	<b>6994</b>	FR6AHX-S	94279	ZFR6AIX-11S	97138	ZFR6BGP-S	92213			.044
2001-99	L4 2.0L		<b>ZFR6F-11</b>	<b>4291</b>	FR6AHX-S	94279	ZFR6FIX-11	6441	ZFR6FGP	7100	ZFR6F-11	4291	.044
1998-97	L4 2.0L		<b>ZFR5F-11</b>	<b>2262</b>	FR5AHX	95839	ZFR5FIX-11	2477	ZFR5FGP	7098	ZFR5F-11	2262	.044
<b>CRX</b>													
1991-90	L4 1.5L	Eng Desg D15B2	<b>BCPR6E-11</b>	<b>5632</b>			BCPR6EIX-11	4919	BCPR6EGP	7088	BCPR6E-11	5632	.044
		Eng Desg D15B6	<b>BCPR5E-11</b>	<b>1273</b>			BCPR5EIX-11	3306	BCPR5EGP	7086	BCPR5E-11	1273	.044
	L4 1.6L		<b>BCPR6E-11</b>	<b>5632</b>			BCPR6EIX-11	4919	BCPR6EGP	7088	BCPR6E-11	5632	.044
1989	L4 1.5L	Base	<b>BCPR6E-11</b>	<b>5632</b>			BCPR6EIX-11	4919	BCPR6EGP	7088	BCPR6E-11	5632	.044
		HF	<b>BCPR5E-11</b>	<b>1273</b>			BCPR5EIX-11	3306	BCPR5EGP	7086	BCPR5E-11	1273	.044
	L4 1.6L		<b>BCPR6E-11</b>	<b>5632</b>			BCPR6EIX-11	4919	BCPR6EGP	7088	BCPR6E-11	5632	.044
1988	L4 1.5L	DX	<b>BCPR6E-11</b>	<b>5632</b>			BCPR6EIX-11	4919	BCPR6EGP	7088	BCPR6E-11	5632	.044
		HF	<b>BCPR5E-11</b>	<b>1273</b>			BCPR5EIX-11	3306	BCPR5EGP	7086	BCPR5E-11	1273	.044
	L4 1.6L		<b>BCPR6E-11</b>	<b>5632</b>			BCPR6EIX-11	4919	BCPR6EGP	7088	BCPR6E-11	5632	.044
<b>CR-Z</b>													
2016-11	L4 1.5L		<b>DIFR6D13</b>	<b>94167</b>	FR6AHX-S	94279	BKR6EIX-11	3764	BKR6EGP	7092			.052
<b>Element</b>													
2011-03	L4 2.4L		<b>IZFR6K11</b>	<b>6994</b>	FR6AHX-S	94279	ZFR6AIX-11S	97138	ZFR6BGP-S	92213			.044
<b>Fit</b>													
2019-15	L4 1.5L		<b>DILZKAR7C11S</b>	<b>90137</b>	LKR7AHX-S	92274	LKR7BIX-11S	93501	LKR7BGP-S	92649			.044
2014-07	L4 1.5L		<b>IZFR6K13</b>	<b>6774</b>	FR6AHX-S	94279	ZFR6AIX-11S	97138	ZFR6BGP-S	92213			.052
<b>HR-V</b>													
2018-16	L4 1.8L		<b>DILZKR7B11GS</b>	<b>95710</b>	LKR7AHX-S	96358	LKR7DIX-11S	93175	LKR7BGP-S	97390			.044
<b>Insight</b>													
2014-10	L4 1.3L	Dual Plug; 8 Req'd	<b>DILFR6J11</b>	<b>92491</b>	FR6AHX-S	94122	FR6AIX-11	6619	FR6CGP	1483			.044
<b>Odyssey</b>													
2019-18	V6 3.5L		<b>DILZKR7B11G</b>	<b>95350</b>	LKR7AHX-S	96358	LKR7DIX-11S	93175	LKR7BGP-S	97390			.044
2017-11	V6 3.5L		<b>DILZKR7A11G</b>	<b>92924</b>	LKR7AHX-S	96358	LKR7DIX-11S	93175	LKR7BGP-S	97390			.044
2010-08	V6 3.5L	Eng Desg J35A6	<b>IZFR5K11</b>	<b>3657</b>			ZFR5AIX-11	94553	ZFR5BGP	90804			.044
		Eng Desg J35A7	<b>ILZKR7B11</b>	<b>7751</b>	LKR7AHX-S	96358	LKR7DIX-11S	93175	LKR7BGP-S	97390			.044
2007-05	V6 3.5L		<b>IZFR5K11</b>	<b>3657</b>			ZFR5AIX-11	94553	ZFR5BGP	90804			.044
2004	V6 3.5L	Eng Desg J35A4	<b>PZFR5F-11</b>	<b>4363</b>	FR5AHX	95839	ZFR5FIX-11	2477	ZFR5FGP	7098	ZFR5F-11	2262	.044
		Eng Desg J35A7	<b>IZFR5K11</b>	<b>3657</b>			ZFR5AIX-11	94553	ZFR5BGP	90804			.044
2003-99	V6 3.5L		<b>PZFR5F-11</b>	<b>4363</b>	FR5AHX	95839	ZFR5FIX-11	2477	ZFR5FGP	7098	ZFR5F-11	2262	.044
1998	L4 2.3L		<b>ZFR5F-11</b>	<b>2262</b>	FR5AHX	95839	ZFR5FIX-11	2477	ZFR5FGP	7098	ZFR5F-11	2262	.044
1997	L4 2.2L		<b>ZFR5F-11</b>	<b>2262</b>	FR5AHX	95839	ZFR5FIX-11	2477	ZFR5FGP	7098	ZFR5F-11	2262	.044
1996-95	L4 2.2L		<b>ZFR5F-11</b>	<b>2262</b>			ZFR5FIX-11	2477	ZFR5FGP	7098	ZFR5F-11	2262	.044
<b>Passport</b>													
2002-97	V6 3.2L		<b>PFR5G-11</b>	<b>2647</b>	FR5AHX	95839	BKR5EIX-11	5464	BKR5EGP	7090	BKR5E-N-11	2391	.042
1996-94	L4 2.6L		<b>BPR5ES-11</b>	<b>7634</b>			BPR5EIX-11	2115	BPR5EGP	7082	BPR5EY-11	6937	.042
	V6 3.2L		<b>BKR6E-11</b>	<b>2756</b>			BKR6EIX-11	3764	BKR6EGP	7092	BKR6E-11	2756	.044
<b>Pilot</b>													
2018-16	V6 3.5L		<b>DILZKR7B11G</b>	<b>95350</b>	LKR7AHX-S	96358	LKR7DIX-11S	93175	LKR7BGP-S	97390			.044
2015-14	V6 3.5L		<b>DILZKR7A11G</b>	<b>92924</b>	LKR7AHX-S	96358	LKR7DIX-11S	93175	LKR7BGP-S	97390			.044
2013-12	V6 3.5L		<b>DILZKR7A11DS</b>	<b>90074</b>	LKR7AHX-S	96358	LKR7DIX-11S	93175	LKR7BGP-S	97390			.044
2011-09	V6 3.5L		<b>ILZKR7B11</b>	<b>7751</b>	LKR7AHX-S	96358	LKR7DIX-11S	93175	LKR7BGP-S	97390			.044
2008-06	V6 3.5L		<b>IZFR5K11</b>	<b>3657</b>			ZFR5AIX-11	94553	ZFR5BGP	90804			.044
2005-03	V6 3.5L		<b>PZFR5F-11</b>	<b>4363</b>	FR5AHX	95839	ZFR5FIX-11	2477	ZFR5FGP	7098	ZFR5F-11	2262	.044
<b>Prelude</b>													
2001-97	L4 2.2L		<b>PZFR6F-11</b>	<b>3271</b>	FR6AHX-S	94279	ZFR6FIX-11	6441	ZFR6FGP	7100	ZFR6F-11	4291	.044
1996-95	L4 2.2L	Eng Desg F22A1	<b>ZFR5F-11</b>	<b>2262</b>			ZFR5FIX-11	2477	ZFR5FGP	7098	ZFR5F-11	2262	.044
		Eng Desg H22A1	<b>PZFR6F-11</b>	<b>3271</b>			ZFR6FIX-11	6441	ZFR6FGP	7100	ZFR6F-11	4291	.044





Year	Cyl. L	Notes	Original Equipment		Ruthenium HX		Iridium IX		G-Power		V-Power		Gap
			Part	Stock	Part	Stock	Part	Stock	Part	Stock	Part	Stock	
<b>HONDA (Cont'd)</b>													
<b>Prelude (Cont'd)</b>													
1996-95	L4 2.3L		<b>ZFR6F-11</b>	<b>4291</b>			ZFR6FIX-11	6441	ZFR6FGP	7100	ZFR6F-11	4291	.044
1994	L4 2.2L	Eng Desg F22A1	<b>ZFR5F-11</b>	<b>2262</b>			ZFR5FIX-11	2477	ZFR5FGP	7098	ZFR5F-11	2262	.044
		Eng Desg H22A1	<b>PZFR6F-11</b>	<b>3271</b>			ZFR6FIX-11	6441	ZFR6FGP	7100	ZFR6F-11	4291	.044
	L4 2.3L	Si	<b>ZFR6F-11</b>	<b>4291</b>			ZFR6FIX-11	6441	ZFR6FGP	7100	ZFR6F-11	4291	.044
1993	L4 2.2L	Si 4WS	<b>ZFR5F-11</b>	<b>2262</b>			ZFR5FIX-11	2477	ZFR5FGP	7098	ZFR5F-11	2262	.044
		Eng Desg F22A1	<b>ZFR5F-11</b>	<b>2262</b>			ZFR5FIX-11	2477	ZFR5FGP	7098	ZFR5F-11	2262	.044
	Eng Desg H22A1	<b>ZFR6F-11</b>	<b>4291</b>			ZFR6FIX-11	6441	ZFR6FGP	7100	ZFR6F-11	4291	.044	
1992	L4 2.3L	Si	<b>ZFR6F-11</b>	<b>4291</b>			ZFR6FIX-11	6441	ZFR6FGP	7100	ZFR6F-11	4291	.044
		Si 4WS	<b>ZFR5F-11</b>	<b>2262</b>			ZFR5FIX-11	2477	ZFR5FGP	7098	ZFR5F-11	2262	.044
	L4 2.2L		<b>ZFR5F-11</b>	<b>2262</b>			ZFR5FIX-11	2477	ZFR5FGP	7098	ZFR5F-11	2262	.044
1991	L4 2.3L		<b>ZFR6F-11</b>	<b>4291</b>			ZFR6FIX-11	6441	ZFR6FGP	7100	ZFR6F-11	4291	.044
	L4 2.0L		<b>ZFR5F-11</b>	<b>2262</b>			ZFR5FIX-11	2477	ZFR5FGP	7098	ZFR5F-11	2262	.044
1990	L4 2.1L		<b>ZFR5F-11</b>	<b>2262</b>			ZFR5FIX-11	2477	ZFR5FGP	7098	ZFR5F-11	2262	.044
		CARB	<b>BCPR5E-11</b>	<b>1273</b>			BCPR5EIX-11	3306	BCPR5EGP	7086	BCPR5E-11	1273	.044
	FI	<b>BCPR6EY-N-11</b>	<b>6262</b>			BCPR6EIX-11	4919	BCPR6EGP	7088	BCPR6EY-N-11	6262	.044	
1989-88	L4 2.1L		<b>ZFR5F-11</b>	<b>2262</b>			ZFR5FIX-11	2477	ZFR5FGP	7098	ZFR5F-11	2262	.044
		CARB	<b>BCPR5EY-11</b>	<b>2441</b>			BCPR5EIX-11	3306	BCPR5EGP	7086	BCPR5EY-11	2441	.044
1987-85	L4 2.0L	FI	<b>BCPR6EY-N-11</b>	<b>6262</b>			BCPR6EIX-11	4919	BCPR6EGP	7088	BCPR6EY-N-11	6262	.044
			<b>BPR6EY-11</b>	<b>6261</b>			BPR6EIX-11	3903	BPR6EGP	7084	BPR6EY-11	6261	.044
	L4 1.8L		<b>BPR5EY-11</b>	<b>6937</b>			BPR5EIX-11	2115	BPR5EGP	7082	BPR5EY-11	6937	.044
<b>Ridgeline</b>													
2019-17	V6 3.5L		<b>DILZKR7B11G</b>	<b>95350</b>	LKR7AHX-S	96358	LKR7DIX-11S	93175	LKR7BGP-S	97390			.044
2014-09	V6 3.5L		<b>ILZKR7B11</b>	<b>7751</b>	LKR7AHX-S	96358	LKR7DIX-11S	93175	LKR7BGP-S	97390			.044
2008-06	V6 3.5L		<b>IZFR5K11</b>	<b>3657</b>			ZFR5AIX-11	94553	ZFR5BGP	90804			.044
<b>S2000</b>													
2009-04	L4 2.2L		<b>PFR7G-11S</b>	<b>7772</b>	FR7BHX-S	92400							.044
2003-00	L4 2.0L		<b>PFR7G-11S</b>	<b>7772</b>	FR7BHX-S	92400							.044
<b>Wagovan</b>													
1987-86	L4 1.5L		<b>BUR6EB-11</b>	<b>7037</b>									.044
<b>HUMMER</b>													
<b>H2</b>													
2009-08	V8 6.2L		<b>IZTR5B11</b>	<b>1465</b>	TR5AHX	94567	TR5IX	7397	TR5GP	3186	TR5	2238	.040
2007-03	V8 6.0L		<b>IZTR5B11</b>	<b>1465</b>	TR5AHX	94567	TR5IX	7397	TR5GP	3186	TR5	2238	.040
<b>H3</b>													
2010	L5 3.7L		<b>ILTR5E11</b>	<b>91418</b>	LTR5AHX	90220	LTR5IX-11	4344	LTR5GP	5019			.044
	V8 5.3L		<b>IZTR5B11</b>	<b>1465</b>	TR5AHX	94567	TR5IX	7397	TR5GP	3186	TR5	2238	.040
2009-08	L5 3.7L		<b>ILTR5B11</b>	<b>3474</b>	LTR5AHX	90220	LTR5IX-11	4344	LTR5GP	5019			.044
	V8 5.3L		<b>IZTR5B11</b>	<b>1465</b>	TR5AHX	94567	TR5IX	7397	TR5GP	3186	TR5	2238	.040
2007	L5 3.7L		<b>ILTR5B11</b>	<b>3474</b>	LTR5AHX	90220	LTR5IX-11	4344	LTR5GP	5019			.044
2006	L5 3.5L		<b>ILTR5B11</b>	<b>3474</b>	LTR5AHX	90220	LTR5IX-11	4344	LTR5GP	5019			.044
<b>H3T</b>													
2010	L5 3.7L		<b>ILTR5E11</b>	<b>91418</b>	LTR5AHX	90220	LTR5IX-11	4344	LTR5GP	5019			.044
	V8 5.3L		<b>IZTR5B11</b>	<b>1465</b>	TR5AHX	94567	TR5IX	7397	TR5GP	3186	TR5	2238	.040
2009	L5 3.7L		<b>ILTR5B11</b>	<b>3474</b>	LTR5AHX	90220	LTR5IX-11	4344	LTR5GP	5019			.044
	V8 5.3L		<b>IZTR5B11</b>	<b>1465</b>	TR5AHX	94567	TR5IX	7397	TR5GP	3186	TR5	2238	.040
<b>HYUNDAI</b>													
<b>Accent</b>													
2017-12	L4 1.6L		<b>SILZKR6B10E</b>	<b>93815</b>	LKR6BHX-E	93763	LZKR6AIX	92873	LZKR6AGP-E	94017			.040
2011-06	L4 1.6L		<b>BKR5ES-11</b>	<b>2382</b>	FR5AHX	95839	BKR5EIX-11	5464	BKR5EGP	7090	BKR5E-11	6953	.044
2005-04	L4 1.6L		<b>BKR5ES-11</b>	<b>2382</b>	FR5BHX	96457	BKR5EIX-11	5464	BKR5EGP	7090	BKR5E-11	6953	.044
2003-01	L4 1.5L		<b>BKR5ES-11</b>	<b>2382</b>	FR5BHX	96457	BKR5EIX-11	5464	BKR5EGP	7090	BKR5E-11	6953	.044
	L4 1.6L		<b>BKR5ES-11</b>	<b>2382</b>	FR5BHX	96457	BKR5EIX-11	5464	BKR5EGP	7090	BKR5E-11	6953	.044
2000-97	L4 1.5L		<b>BKR5ES-11</b>	<b>2382</b>	FR5BHX	96457	BKR5EIX-11	5464	BKR5EGP	7090	BKR5E-11	6953	.044
1996-95	L4 1.5L		<b>BKR5ES-11</b>	<b>2382</b>			BKR5EIX-11	5464	BKR5EGP	7090	BKR5E-11	6953	.044
<b>Azera</b>													
2017-12	V6 3.3L		<b>SILZKR7B11</b>	<b>9723</b>	LKR7BHX	94705	LKR7DIX-11S	93175	LKR7BGP-S	97390			.044
2011-07	V6 3.3L		<b>IFR5G11</b>	<b>7854</b>	FR5AHX	95839	BKR5EIX-11	5464	BKR5EGP	7090	BKR5E-11	6953	.044

**Bold denotes NGK OE Manufacturer and/or OE Service Part**  
 NOT BOLD denotes OE Equivalent Part

Note: Due to different operating or engine conditions, alternate heat range plugs may be required.

**Le texte en gras désigne une pièce d'équipement originale du manufacturier NGK et/ou pièce d'équipement originale de service**  
 Le texte non en gras désigne une pièce d'équipement originale équivalente

Note: En raison de différences au niveau du fonctionnement ou des conditions du moteur, d'autres types de bougies avec variation de chaleur peuvent être nécessaires





Year	Cyl. L	Notes	Original Equipment		Ruthenium HX		Iridium IX		G-Power		V-Power		Gap
			Part	Stock	Part	Stock	Part	Stock	Part	Stock	Part	Stock	
<b>HYUNDAI (Cont'd)</b>													
<b>Azera (Cont'd)</b>													
2011-07	V6 3.8L		<b>IFR5G11</b>	<b>7854</b>	FR5AHX	95839	BKR5EIX-11	5464	BKR5EGP	7090	BKR5E-11	6953	.044
2006	V6 3.8L		<b>IFR5G11</b>	<b>7854</b>	FR5AHX	95839	BKR5EIX-11	5464	BKR5EGP	7090	BKR5E-11	6953	.044
<b>Elantra</b>													
2016	L4 1.8L		<b>SILZKR7B11</b>	<b>9723</b>	LKR7BHX	94705	LKR7DIX-11S	93175	LKR7BGP-S	97390			.044
2015-14	L4 1.8L		<b>SILZKR7B11</b>	<b>9723</b>	LKR7BHX	94705	LKR7DIX-11S	93175	LKR7BGP-S	97390			.044
	L4 2.0L		<b>SILZKR7B11</b>	<b>9723</b>	LKR7BHX	94705	LKR7DIX-11S	93175	LKR7BGP-S	97390			.044
2013	L4 1.8L		<b>SILZKR7B11</b>	<b>9723</b>	LKR7BHX	94705	LKR7DIX-11S	93175	LKR7BGP-S	97390			.044
2012	L4 1.8L		<b>SILZKR7B11</b>	<b>9723</b>	LKR7BHX	94705	LKR7DIX-11S	93175	LKR7BGP-S	97390			.044
	L4 2.0L		<b>IZFR5L11</b>	<b>97932</b>	FR5BHX	96457	ZFR5FIX-11	2477	ZFR5FGP	7098	ZFR5F-11	2262	.044
2011	L4 1.8L		<b>SILZKR6B11</b>	<b>6215</b>	LKR6AHX	91356							.044
	L4 2.0L		<b>IZFR5L11</b>	<b>97932</b>	FR5BHX	96457	ZFR5FIX-11	2477	ZFR5FGP	7098	ZFR5F-11	2262	.044
2010-08	L4 2.0L		<b>IZFR5L11</b>	<b>97932</b>	FR5BHX	96457	ZFR5FIX-11	2477	ZFR5FGP	7098	ZFR5F-11	2262	.044
2007	L4 2.0L	Calif. Emissions	<b>IZFR5L11</b>	<b>97932</b>	FR5BHX	96457	ZFR5FIX-11	2477	ZFR5FGP	7098	ZFR5F-11	2262	.044
		Federal Emissions	<b>PFR5N-11</b>	<b>5838</b>	FR5BHX	96457	BKR5EIX-11	5464	BKR5EGP	7090	BKR5E-11	6953	.044
2006-04	L4 2.0L		<b>PFR5N-11</b>	<b>5838</b>	FR5BHX	96457	BKR5EIX-11	5464	BKR5EGP	7090	BKR5E-11	6953	.044
2003	L4 2.0L	Automatic	<b>IFR5G11</b>	<b>7854</b>	FR5BHX	96457	BKR5EIX-11	5464	BKR5EGP	7090	BKR5E-11	6953	.044
		Manual	<b>PFR5N-11</b>	<b>5838</b>	FR5BHX	96457	BKR5EIX-11	5464	BKR5EGP	7090	BKR5E-11	6953	.044
2002-01	L4 2.0L		<b>PFR5N-11</b>	<b>5838</b>	FR5BHX	96457	BKR5EIX-11	5464	BKR5EGP	7090	BKR5E-11	6953	.044
2000-99	L4 2.0L		<b>BKR5ES-11</b>	<b>2382</b>	FR5BHX	96457	BKR5EIX-11	5464	BKR5EGP	7090	BKR5E-11	6953	.044
1998-97	L4 1.8L		<b>BKR5ES-11</b>	<b>2382</b>	FR5BHX	96457	BKR5EIX-11	5464	BKR5EGP	7090	BKR5E-11	6953	.044
1996	L4 1.8L		<b>BKR5ES-11</b>	<b>2382</b>			BKR5EIX-11	5464	BKR5EGP	7090	BKR5E-11	6953	.044
1995-93	L4 1.6L		<b>BPR6ES-11</b>	<b>7133</b>			BPR6EIX-11	3903	BPR6EGP	7084	BPR6EY-11	6261	.044
	L4 1.8L		<b>BPR6ES-11</b>	<b>7133</b>			BPR6EIX-11	3903	BPR6EGP	7084	BPR6EY-11	6261	.044
1992	L4 1.6L		<b>BPR6ES-11</b>	<b>7133</b>			BPR6EIX-11	3903	BPR6EGP	7084	BPR6EY-11	6261	.044
<b>Elantra Coupe</b>													
2014	L4 2.0L		<b>SILZKR7B11</b>	<b>9723</b>	LKR7BHX	94705	LKR7DIX-11S	93175	LKR7BGP-S	97390			.044
2013	L4 1.8L		<b>SILZKR7B11</b>	<b>9723</b>	LKR7BHX	94705	LKR7DIX-11S	93175	LKR7BGP-S	97390			.044
<b>Elantra GT</b>													
2015-14	L4 2.0L		<b>SILZKR7B11</b>	<b>9723</b>	LKR7BHX	94705	LKR7DIX-11S	93175	LKR7BGP-S	97390			.044
2013	L4 1.8L		<b>SILZKR7B11</b>	<b>9723</b>	LKR7BHX	94705	LKR7DIX-11S	93175	LKR7BGP-S	97390			.044
<b>Entourage</b>													
2010-07	V6 3.8L		<b>IFR5G11</b>	<b>7854</b>	FR5AHX	95839	BKR5EIX-11	5464	BKR5EGP	7090	BKR5E-11	6953	.044
<b>Equus</b>													
2016-12	V8 5.0L		<b>DILKR7A11</b>	<b>93135</b>	LKR7AHX-S	96358	LKR7DIX-11S	93175	LKR7BGP-S	97390			.044
2011	V8 4.6L		<b>DILFR5E11</b>	<b>92605</b>	LFR5AHX	96355	LFR5AIX-11	4469	LFR5AGP	5018			.044
<b>Excel</b>													
1994-86	L4 1.5L		<b>BPR6ES-11</b>	<b>7133</b>			BPR6EIX-11	3903	BPR6EGP	7084	BPR6EY-11	6261	.044
<b>Genesis</b>													
2016-13	V6 3.8L		<b>DILKR7A11</b>	<b>93135</b>	LKR7AHX-S	96358	LKR7DIX-11S	93175	LKR7BGP-S	97390			.044
	V8 5.0L		<b>DILKR7A11</b>	<b>93135</b>	LKR7AHX-S	96358	LKR7DIX-11S	93175	LKR7BGP-S	97390			.044
2012	V6 3.8L		<b>DILKR7A11</b>	<b>93135</b>	LKR7AHX-S	96358	LKR7DIX-11S	93175	LKR7BGP-S	97390			.044
	V8 4.6L		<b>DILFR5E11</b>	<b>92605</b>	LFR5AHX	96355	LFR5AIX-11	4469	LFR5AGP	5018			.044
	V8 5.0L		<b>DILKR7A11</b>	<b>93135</b>	LKR7AHX-S	96358	LKR7DIX-11S	93175	LKR7BGP-S	97390			.044
2011-10	V8 4.6L		<b>DILFR5E11</b>	<b>92605</b>	LFR5AHX	96355	LFR5AIX-11	4469	LFR5AGP	5018			.044
2009	V6 3.8L	Build Date Before 5/1/2008	<b>ILFR5B11</b>	<b>1637</b>	LFR5AHX	96355	LFR5AIX-11	4469	LFR5AGP	5018	LFR5A-11	6376	.044
		Build Date From 5/1/2008 To 3/17/2009	<b>SILZKR6B11</b>	<b>6215</b>	LKR6AHX	91356							.044
	V8 4.6L		<b>DILFR5E11</b>	<b>92605</b>	LFR5AHX	96355	LFR5AIX-11	4469	LFR5AGP	5018			.044
<b>Genesis Coupe</b>													
2016-15	V6 3.8L		<b>SILZKR7B11</b>	<b>9723</b>	LKR7BHX	94705	LKR7DIX-11S	93175	LKR7BGP-S	97390			.044
2014-13	L4 2.0L		<b>ILFR6B</b>	<b>6481</b>	LFR6BHX	93420	LFR6AIX	93893	LFR6CGP	1483			.032
	V6 3.8L		<b>SILZKR7B11</b>	<b>9723</b>	LKR7BHX	94705	LKR7DIX-11S	93175	LKR7BGP-S	97390			.044
2012-10	V6 3.8L		<b>SILZKR7B11</b>	<b>9723</b>	LKR7BHX	94705	LKR7DIX-11S	93175	LKR7BGP-S	97390			.044
<b>Pony</b>													
1987	L4 1.4L		<b>BPR6ES</b>	<b>7131</b>			BPR6EIX	6637	BPR6EGP	7084	BPR6EY	6427	.032
	L4 1.6L		<b>BPR6ES</b>	<b>7131</b>			BPR6EIX	6637	BPR6EGP	7084	BPR6EY	6427	.032



Year	Cyl. L	Notes	Original Equipment		Ruthenium HX		Iridium IX		G-Power		V-Power		Gap
			Part	Stock	Part	Stock	Part	Stock	Part	Stock	Part	Stock	
<b>HYUNDAI (Cont'd)</b>													
<b>Pony (Cont'd)</b>													
1986	L4 1.4L		BPR6ES	7131			BPR6EIX	6637	BPR6EGP	7084	BPR6EY	6427	.032
	L4 1.5L		BPR6ES	7131			BPR6EIX	6637	BPR6EGP	7084	BPR6EY	6427	.032
1985	L4 1.4L		BPR6ES	7131			BPR6EIX	6637	BPR6EGP	7084	BPR6EY	6427	.032
	L4 1.6L		BPR6ES	7131			BPR6EIX	6637	BPR6EGP	7084	BPR6EY	6427	.032
<b>Santa Fe</b>													
2018-13	V6 3.3L		<b>SILZKR7B11</b>	<b>9723</b>	LKR7BHX	94705	LKR7DIX-11S	93175	LKR7BGP-S	97390			.044
2012-10	L4 2.4L		DILFR5A-11D	98376	LF55AHX	96355	LF55AIX-11	4469	LF55AGP	5018			.044
	V6 3.5L		<b>SILZKR7B11</b>	<b>9723</b>	LKR7BHX	94705	LKR7DIX-11S	93175	LKR7BGP-S	97390			.044
2009-07	V6 2.7L		<b>ILFR5B11</b>	<b>1637</b>	LF55AHX	96355	LF55AIX-11	4469	LF55AGP	5018	LF55A-11	6376	.044
	V6 3.3L		<b>IFR5G11</b>	<b>7854</b>	FR5AHX	95839	BKR5EIX-11	5464	BKR5EGP	7090	BKR5E-11	6953	.044
2006-03	L4 2.4L		<b>PGR5C-11</b>	<b>5760</b>			BPR5EIX-11	2115	BPR5EGP	7082	BPR5EY-11	6937	.044
	V6 2.7L		<b>PFR5N-11</b>	<b>5838</b>	FR5BHX	96457	BKR5EIX-11	5464	BKR5EGP	7090	BKR5E-11	6953	.044
	V6 3.5L		<b>PFR5N-11</b>	<b>5838</b>	FR5BHX	96457	BKR5EIX-11	5464	BKR5EGP	7090	BKR5E-11	6953	.044
2002-01	L4 2.4L		<b>PGR5C-11</b>	<b>5760</b>			BPR5EIX-11	2115	BPR5EGP	7082	BPR5EY-11	6937	.044
	V6 2.7L		<b>PFR5N-11</b>	<b>5838</b>	FR5BHX	96457	BKR5EIX-11	5464	BKR5EGP	7090	BKR5E-11	6953	.044
<b>Santa Fe Sport</b>													
2018-16	L4 2.4L		<b>SILZKR7E11</b>	<b>92315</b>	LKR7AHX-S	96358	LKR7DIX-11S	93175					.044
2015-13	L4 2.4L		DILKR6C11	93199									.044
<b>Santa Fe XL</b>													
2018-13	V6 3.3L		<b>SILZKR7B11</b>	<b>9723</b>	LKR7BHX	94705	LKR7DIX-11S	93175	LKR7BGP-S	97390			.044
<b>Scoupe</b>													
1995-93	L4 1.5L	Naturally Aspirated	<b>BKR5ES-11</b>	<b>2382</b>			BKR5EIX-11	5464	BKR5EGP	7090	BKR5E-11	6953	.044
		Turbo	<b>BKR6E</b>	<b>6962</b>			BKR6EIX	6418	BKR6EGP	7092	BKR6E	6962	.035
1992-91	L4 1.5L		<b>BPR6ES-11</b>	<b>7133</b>			BPR6EIX-11	3903	BPR6EGP	7084	BPR6EY-11	6261	.044
<b>Sonata</b>													
2018-16	L4 2.4L		<b>SILZKR7E11</b>	<b>92315</b>	LKR7AHX-S	96358	LKR7DIX-11S	93175					.044
2015	L4 2.0L	To 1/2/2015	<b>SILZKR7E9G</b>	<b>91467</b>			LKR7DIX-11S	93175					.036
	L4 2.4L	GAS	<b>SILZKR7E11</b>	<b>92315</b>	LKR7AHX-S	96358	LKR7DIX-11S	93175					.044
2014-11	L4 2.4L	GAS	DILKR6C11	93199									.044
2010-09	L4 2.4L		DILFR5A-11D	98376	LF55AHX	96355	LF55AIX-11	4469	LF55AGP	5018			.044
	V6 3.3L		<b>IFR5G11</b>	<b>7854</b>	FR5AHX	95839	BKR5EIX-11	5464	BKR5EGP	7090	BKR5E-11	6953	.044
2008-07	L4 2.4L		IFR5E11	7994	FR5AHX	95839	BKR5EIX-11	5464	BKR5EGP	7090	BKR5E-11	6953	.044
	V6 3.3L		<b>IFR5G11</b>	<b>7854</b>	FR5AHX	95839	BKR5EIX-11	5464	BKR5EGP	7090	BKR5E-11	6953	.044
2006	L4 2.4L		IFR5E11	7994	FR5AHX	95839	BKR5EIX-11	5464	BKR5EGP	7090	BKR5E	7938	.044
	V6 3.3L		<b>IFR5G11</b>	<b>7854</b>	FR5AHX	95839	BKR5EIX-11	5464	BKR5EGP	7090	BKR5E-11	6953	.044
2005-02	L4 2.4L		<b>PGR5C-11</b>	<b>5760</b>			BPR5EIX-11	2115	BPR5EGP	7082	BPR5EY-11	6937	.044
	V6 2.7L		<b>PFR5N-11</b>	<b>5838</b>	FR5BHX	96457	BKR5EIX-11	5464	BKR5EGP	7090	BKR5E-11	6953	.044
2001-99	L4 2.4L		<b>PGR5C-11</b>	<b>5760</b>			BPR5EIX-11	2115	BPR5EGP	7082	BPR5EY-11	6937	.044
	V6 2.5L		<b>PFR5N-11</b>	<b>5838</b>	FR5BHX	96457	BKR5EIX-11	5464	BKR5EGP	7090	BKR5E-11	6953	.044
1998-92	L4 2.0L		<b>BPR6ES-11</b>	<b>7133</b>			BPR6EIX-11	3903	BPR6EGP	7084	BPR6EY-11	6261	.044
	V6 3.0L		<b>PGR5A-11</b>	<b>3573</b>			BPR5EIX-11	2115	BPR5EGP	7082	BPR5EY-11	6937	.044
1991-90	L4 2.4L		<b>BPR6ES-11</b>	<b>7133</b>			BPR6EIX-11	3903	BPR6EGP	7084	BPR6EY-11	6261	.044
	V6 3.0L		<b>PGR5A-11</b>	<b>3573</b>			BPR5EIX-11	2115	BPR5EGP	7082	BPR5EY-11	6937	.044
1989	L4 2.4L		<b>BPR6ES-11</b>	<b>7133</b>			BPR6EIX-11	3903	BPR6EGP	7084	BPR6EY-11	6261	.044
<b>Stellar</b>													
1987	L4 2.0L		BPR6ES	7131			BPR6EIX	6637	BPR6EGP	7084	BPR6EY	6427	.032
1986-85	L4 1.6L		BPR6ES	7131			BPR6EIX	6637	BPR6EGP	7084	BPR6EY	6427	.032
<b>Tiburon</b>													
2008	L4 2.0L		<b>PFR5N-11</b>	<b>5838</b>	FR5BHX	96457	BKR5EIX-11	5464	BKR5EGP	7090	BKR5E-11	6953	.044
	V6 2.7L		<b>IFR5G11</b>	<b>7854</b>	FR5BHX	96457	BKR5EIX-11	5464	BKR5EGP	7090	BKR5E-11	6953	.044
2007-03	L4 2.0L		<b>PFR5N-11</b>	<b>5838</b>	FR5BHX	96457	BKR5EIX-11	5464	BKR5EGP	7090	BKR5E-11	6953	.044
	V6 2.7L		<b>PFR5N-11</b>	<b>5838</b>	FR5BHX	96457	BKR5EIX-11	5464	BKR5EGP	7090	BKR5E-11	6953	.044
2001-98	L4 2.0L		<b>BKR5ES-11</b>	<b>2382</b>	FR5BHX	96457	BKR5EIX-11	5464	BKR5EGP	7090	BKR5E-11	6953	.044
1997	L4 1.8L		<b>BKR5ES-11</b>	<b>2382</b>	FR5BHX	96457	BKR5EIX-11	5464	BKR5EGP	7090	BKR5E-11	6953	.044
	L4 2.0L		<b>BKR5ES-11</b>	<b>2382</b>	FR5BHX	96457	BKR5EIX-11	5464	BKR5EGP	7090	BKR5E-11	6953	.044
<b>Tucson</b>													
2017-16	L4 2.0L		<b>SILZKR7B11</b>	<b>9723</b>	LKR7BHX	94705	LKR7DIX-11S	93175	LKR7BGP-S	97390			.044

**Bold denotes NGK OE Manufacturer and/or OE Service Part**  
NOT BOLD denotes OE Equivalent Part

**Le texte en gras désigne une pièce d'équipement originale du manufacturier NGK et/ou pièce d'équipement originale de service**  
Le texte non en gras désigne une pièce d'équipement originale équivalente

Note: Due to different operating or engine conditions, alternate heat range plugs may be required.

Note: En raison de différences au niveau du fonctionnement ou des conditions du moteur, d'autres types de bougies avec variation de chaleur peuvent être nécessaires



Year	Cyl. L	Notes	Original Equipment		Ruthenium HX		Iridium IX		G-Power		V-Power		Gap
			Part	Stock	Part	Stock	Part	Stock	Part	Stock	Part	Stock	
<b>HYUNDAI (Cont'd)</b>													
<b>Tucson (Cont'd)</b>													
2015-14	L4 2.0L		<b>SILZKR7B11</b>	<b>9723</b>	LKR7BHX	94705	LKR7DIX-11S	93175	LKR7BGP-S	97390			.044
	L4 2.4L		DILKR6C11	93199									.044
2013-11	L4 2.0L		DILFR5A-11D	98376	LFR5AHX	96355	LFR5AIX-11	4469	LFR5AGP	5018			.044
	L4 2.4L		DILFR5A-11D	98376	LFR5AHX	96355	LFR5AIX-11	4469	LFR5AGP	5018			.044
2010	L4 2.4L		DILFR5A-11D	98376	LFR5AHX	96355	LFR5AIX-11	4469	LFR5AGP	5018			.044
2009-05	L4 2.0L		<b>PFR5N-11</b>	<b>5838</b>	FR5BHX	96457	BKR5EIX-11	5464	BKR5EGP	7090	BKR5E-11	6953	.044
	V6 2.7L		<b>IFR5G11</b>	<b>7854</b>	FR5BHX	96457	BKR5EIX-11	5464	BKR5EGP	7090	BKR5E-11	6953	.044
<b>Veloster</b>													
2017-16	L4 1.6L	Naturally Aspirated	<b>SILZKR6B10E</b>	<b>93815</b>	LKR6BHX-E	93763	LZKR6AIX	92873	LZKR6AGP-E	94017			.040
2015	L4 1.6L	Naturally Aspirated	<b>SILZKR6B10E</b>	<b>93815</b>	LKR6BHX-E	93763	LZKR6AIX	92873	LZKR6AGP-E	94017			.040
		Turbo, To 12/23/2014	<b>SILZKR7E8EG</b>	<b>93655</b>									.032
2014	L4 1.6L	Naturally Aspirated	<b>SILZKR6B10E</b>	<b>93815</b>	LKR6BHX-E	93763	LZKR6AIX	92873	LZKR6AGP-E	94017			.040
		Turbo, From 2/28/2014	<b>SILZKR7E8EG</b>	<b>93655</b>									.032
		Turbo, To 2/28/2014	<b>SILZKR6D8E</b>	<b>91568</b>	LKR6BHX-E	93763	LKR6CIX	93126	LKR6BGP-E	96002			.032
2013	L4 1.6L	Naturally Aspirated	<b>SILZKR6B10E</b>	<b>93815</b>	LKR6BHX-E	93763	LZKR6AIX	92873	LZKR6AGP-E	94017			.040
		Turbo	<b>SILZKR6D8E</b>	<b>91568</b>	LKR6BHX-E	93763	LKR6CIX	93126	LKR6BGP-E	96002			.032
2012	L4 1.6L		<b>SILZKR6B10E</b>	<b>93815</b>	LKR6BHX-E	93763	LZKR6AIX	92873	LZKR6AGP-E	94017			.040
<b>Veracruz</b>													
2012-07	V6 3.8L		<b>IFR5G11</b>	<b>7854</b>	FR5AHX	95839	BKR5EIX-11	5464	BKR5EGP	7090	BKR5E-11	6953	.044
<b>XG300</b>													
2001	V6 3.0L		PFR5N-11	5838	FR5BHX	96457	BKR5EIX-11	5464	BKR5EGP	7090	BKR5E-11	6953	.044
<b>XG350</b>													
2005-02	V6 3.5L		PFR5N-11	5838	FR5BHX	96457	BKR5EIX-11	5464	BKR5EGP	7090	BKR5E-11	6953	.044
<b>INFINITI</b>													
<b>EX35</b>													
2012-08	V6 3.5L		DILKAR7B11	1406	LKAR7AHX-S	92274	LKAR7BIX-11S	93501	LKAR7AGP-D	93220			.044
<b>EX37</b>													
2013	V6 3.7L		DF8H-11B	90174	LKAR8BHX	91784							.044
<b>FX35</b>													
2012-09	V6 3.5L		DILKAR7B11	1406	LKAR7AHX-S	92274	LKAR7BIX-11S	93501	LKAR7AGP-D	93220			.044
2008-03	V6 3.5L		<b>PLFR5A-11</b>	<b>6240</b>	LFR5AHX	96355	LFR5AIX-11	4469	LFR5AGP	5018	LFR5A-11	6376	.044
<b>FX37</b>													
2013	V6 3.7L		DF8H-11B	90174	LKAR8BHX	91784							.044
<b>FX45</b>													
2008-03	V8 4.5L		<b>PLFR5A-11</b>	<b>6240</b>	LFR5AHX	96355	LFR5AIX-11	4469	LFR5AGP	5018	LFR5A-11	6376	.044
<b>FX50</b>													
2013-09	V8 5.0L		DILKAR7B11	1406	LKAR7AHX-S	92274	LKAR7BIX-11S	93501	LKAR7AGP-D	93220			.044
<b>G20</b>													
2002-99	L4 2.0L		<b>PFR5G-11</b>	<b>2647</b>	FR5AHX	95839	BKR5EIX-11	5464	BKR5EGP	7090	BKR5E-11	6953	.044
1996-91	L4 2.0L		<b>PFR6B-11</b>	<b>4014</b>			BKR6EIX-11	3764	BKR6EGP	7092	BKR6E-11	2756	.044
<b>G25</b>													
2012-11	V6 2.5L		DILKAR7B11	1406	LKAR7AHX-S	92274	LKAR7BIX-11S	93501	LKAR7AGP-D	93220			.044
<b>G35</b>													
2008	V6 3.5L		DILKAR7B11	1406	LKAR7AHX-S	92274	LKAR7BIX-11S	93501	LKAR7AGP-D	93220			.044
2007	V6 3.5L	Eng Desg VQ35DE	<b>PLFR5A-11</b>	<b>6240</b>	LFR5AHX	96355	LFR5AIX-11	4469	LFR5AGP	5018	LFR5A-11	6376	.044
		Eng Desg VQ35HR	DILKAR7B11	1406	LKAR7AHX-S	92274	LKAR7BIX-11S	93501	LKAR7AGP-D	93220			.044
2006-03	V6 3.5L		<b>PLFR5A-11</b>	<b>6240</b>	LFR5AHX	96355	LFR5AIX-11	4469	LFR5AGP	5018	LFR5A-11	6376	.044
<b>G37</b>													
2013-08	V6 3.7L		DF8H-11B	90174	LKAR8BHX	91784							.044
<b>I30</b>													
2001-97	V6 3.0L		<b>PFR5G-11</b>	<b>2647</b>	FR5AHX	95839	BKR5EIX-11	5464	BKR5EGP	7090	BKR5E-11	6953	.044
1996	V6 3.0L		<b>PFR5G-11</b>	<b>2647</b>			BKR5EIX-11	5464	BKR5EGP	7090	BKR5E-11	6953	.044
<b>I35</b>													
2004-02	V6 3.5L		<b>PLFR5A-11</b>	<b>6240</b>	LFR5AHX	96355	LFR5AIX-11	4469	LFR5AGP	5018	LFR5A-11	6376	.044
<b>J30</b>													
1997	V6 3.0L		<b>PFR5G-11</b>	<b>2647</b>	FR5AHX	95839	BKR5EIX-11	5464	BKR5EGP	7090	BKR5E-11	6953	.044



Year	Cyl. L	Notes	Original Equipment		Ruthenium HX		Iridium IX		G-Power		V-Power		Gap
			Part	Stock	Part	Stock	Part	Stock	Part	Stock	Part	Stock	
<b>INFINITI (Cont'd)</b>													
<b>J30 (Cont'd)</b>													
1996-93	V6 3.0L		<b>PFR5G-11</b>	<b>2647</b>			BKR5EIX-11	5464	BKR5EGP	7090	BKR5E-11	6953	.044
<b>JX35</b>													
2013	V6 3.5L		DILKAR7B11	1406	LKAR7AHX-S	92274	LKAR7BIX-11S	93501	LKAR7AGP-D	93220			.044
<b>M30</b>													
1992-90	V6 3.0L		<b>PFR6B-11</b>	<b>4014</b>			BKR6EIX-11	3764	BKR6EGP	7092	BKR6E-11	2756	.044
<b>M35</b>													
2010-09	V6 3.5L		DILKAR7B11	1406	LKAR7AHX-S	92274	LKAR7BIX-11S	93501	LKAR7AGP-D	93220			.044
2008-06	V6 3.5L		<b>PLFR5A-11</b>	<b>6240</b>	LF5AHX	96355	LF5AIX-11	4469	LF5AGP	5018	LF5A-11	6376	.044
<b>M35h</b>													
2013-12	V6 3.5L		DILKAR7B11	1406	LKAR7AHX-S	92274	LKAR7BIX-11S	93501	LKAR7AGP-D	93220			.044
<b>M37</b>													
2013-11	V6 3.7L		DF8H-11B	90174	LKAR8BHX	91784							.044
<b>M45</b>													
2010-06	V8 4.5L		<b>PLFR5A-11</b>	<b>6240</b>	LF5AHX	96355	LF5AIX-11	4469	LF5AGP	5018	LF5A-11	6376	.044
2004-03	V8 4.5L		<b>PLFR5A-11</b>	<b>6240</b>	LF5AHX	96355	LF5AIX-11	4469	LF5AGP	5018	LF5A-11	6376	.044
<b>M56</b>													
2013-11	V8 5.6L		<b>DILKAR7B11</b>	<b>1406</b>	LKAR7AHX-S	92274	LKAR7BIX-11S	93501	LKAR7AGP-D	93220			.044
<b>Q40</b>													
2015	V6 3.7L		DF8H-11B	90174	LKAR8BHX	91784							.044
<b>Q45</b>													
2006-02	V8 4.5L		<b>PLFR5A-11</b>	<b>6240</b>	LF5AHX	96355	LF5AIX-11	4469	LF5AGP	5018	LF5A-11	6376	.044
2001-97	V8 4.1L		<b>PFR5G-11</b>	<b>2647</b>	FR5AHX	95839	BKR5EIX-11	5464	BKR5EGP	7090	BKR5E-11	6953	.044
1996-94	V8 4.5L		<b>PFR5G-11</b>	<b>2647</b>			BKR5EIX-11	5464	BKR5EGP	7090	BKR5E-11	6953	.044
1993-90	V8 4.5L		<b>PFR5B-11</b>	<b>2300</b>			BKR5EIX-11	5464	BKR5EGP	7090	BKR5E-11	6953	.044
<b>Q50</b>													
2018	V6 3.5L		DILKAR7B11	1406	LKAR7AHX-S	92274	LKAR7BIX-11S	93501	LKAR7AGP-D	93220			.044
2017	L4 2.0L	Sedan	<b>SILZKFR8E7S</b>	<b>90654</b>									.028
	V6 3.5L		DILKAR7B11	1406	LKAR7AHX-S	92274	LKAR7BIX-11S	93501	LKAR7AGP-D	93220			.044
2016	L4 2.0L		<b>SILZKFR8E7S</b>	<b>90654</b>									.028
	V6 3.5L		DILKAR7B11	1406	LKAR7AHX-S	92274	LKAR7BIX-11S	93501	LKAR7AGP-D	93220			.044
2015-14	V6 3.5L		DILKAR7B11	1406	LKAR7AHX-S	92274	LKAR7BIX-11S	93501	LKAR7AGP-D	93220			.044
	V6 3.7L		DF8H-11B	90174	LKAR8BHX	91784							.044
<b>Q60</b>													
2015	V6 3.7L		DF8H-11B	90174	LKAR8BHX	91784							.044
2014	V6 3.7L		DILKAR7B11	1406	LKAR7AHX-S	92274	LKAR7BIX-11S	93501	LKAR7AGP-D	93220			.044
<b>Q70</b>													
2017-14	V6 3.5L		DILKAR7B11	1406	LKAR7AHX-S	92274	LKAR7BIX-11S	93501	LKAR7AGP-D	93220			.044
	V6 3.7L		DF8H-11B	90174	LKAR8BHX	91784							.044
	V8 5.6L		<b>DILKAR7B11</b>	<b>1406</b>	LKAR7AHX-S	92274	LKAR7BIX-11S	93501	LKAR7AGP-D	93220			.044
<b>Q70L</b>													
2017-15	V6 3.7L		DF8H-11B	90174	LKAR8BHX	91784							.044
	V8 5.6L		<b>DILKAR7B11</b>	<b>1406</b>	LKAR7AHX-S	92274	LKAR7BIX-11S	93501	LKAR7AGP-D	93220			.044
<b>QX4</b>													
2003-01	V6 3.5L		<b>PLFR5A-11</b>	<b>6240</b>	LF5AHX	96355	LF5AIX-11	4469	LF5AGP	5018	LF5A-11	6376	.044
2000-98	V6 3.3L		<b>FR5AP-10</b>	<b>6371</b>	FR5AHX	95839	BKR5EIX-11	5464	BKR5EGP	7090	BKR5E-11	6953	.039
1997	V6 3.3L		<b>BKR5E-11</b>	<b>6953</b>	FR5AHX	95839	BKR5EIX-11	5464	BKR5EGP	7090	BKR5E-11	6953	.044
<b>QX50</b>													
2017-14	V6 3.7L		DF8H-11B	90174	LKAR8BHX	91784							.044
<b>QX56</b>													
2013-11	V8 5.6L		<b>DILKAR7B11</b>	<b>1406</b>	LKAR7AHX-S	92274	LKAR7BIX-11S	93501	LKAR7AGP-D	93220			.044
2010-07	V8 5.6L		<b>DILFR5A11</b>	<b>93759</b>	LF5AHX	96355	LF5AIX-11	4469	LF5AGP	5018			.044
2006-04	V8 5.6L		<b>PLFR5A-11</b>	<b>6240</b>	LF5AHX	96355	LF5AIX-11	4469	LF5AGP	5018	LF5A-11	6376	.044
<b>QX60</b>													
2017-14	L4 2.5L		<b>DILKAR7C9H</b>	<b>91215</b>									.036
	V6 3.5L		DILKAR7B11	1406	LKAR7AHX-S	92274	LKAR7BIX-11S	93501	LKAR7AGP-D	93220			.044
<b>QX70</b>													
2017-15	V6 3.7L		DF8H-11B	90174	LKAR8BHX	91784							.044

**Bold denotes NGK OE Manufacturer and/or OE Service Part**  
NOT BOLD denotes OE Equivalent Part

**Le texte en gras désigne une pièce d'équipement originale du manufacturier NGK et/ou pièce d'équipement originale de service**  
Le texte non en gras désigne une pièce d'équipement originale équivalente

Note: Due to different operating or engine conditions, alternate heat range plugs may be required.

Note: En raison de différences au niveau du fonctionnement ou des conditions du moteur, d'autres types de bougies avec variation de chaleur peuvent être nécessaires



Year	Cyl. L	Notes	Original Equipment		Ruthenium HX		Iridium IX		G-Power		V-Power		Gap
			Part	Stock	Part	Stock	Part	Stock	Part	Stock	Part	Stock	
<b>INFINITI (Cont'd)</b>													
<b>QX70 (Cont'd)</b>													
2014	V6 3.7L		DF8H-11B	90174	LKAR8BHx	91784							.044
	V8 5.0L		DILKAR7B11	1406	LKAR7AHX-S	92274	LKAR7BIX-11S	93501	LKAR7AGP-D	93220			.044
<b>QX80</b>													
2017-14	V8 5.6L		<b>DILKAR7B11</b>	<b>1406</b>	LKAR7AHX-S	92274	LKAR7BIX-11S	93501	LKAR7AGP-D	93220			.044
<b>ISUZU</b>													
<b>Amigo</b>													
2000-99	L4 2.2L		PFR5G-11	2647	FR5BHx	96457	BKR5EIX-11	5464	BKR5EGP	7090	BKR5EY-11	6745	.042
	V6 3.2L		<b>PFR5G-11</b>	<b>2647</b>	FR5AHX	95839	BKR5EIX-11	5464	BKR5EGP	7090	BKR5EY-11	6745	.042
1998	L4 2.2L		BKR5EY-11	6745	FR5BHx	96457	BKR5EIX-11	5464	BKR5EGP	7090	BKR5EY-11	6745	.042
	V6 3.2L		<b>PFR5G-11</b>	<b>2647</b>	FR5AHX	95839	BKR5EIX-11	5464	BKR5EGP	7090	BKR5EY-11	6745	.042
1994	L4 2.6L		<b>BPR5ES-11</b>	<b>7634</b>			BPR5EIX-11	2115	BPR5EGP	7082	BPR5EY-11	6937	.044
1993-90	L4 2.3L		<b>BPR5ES-11</b>	<b>7634</b>			BPR5EIX-11	2115	BPR5EGP	7082	BPR5EY-11	6937	.040
	L4 2.6L		<b>BPR5ES-11</b>	<b>7634</b>			BPR5EIX-11	2115	BPR5EGP	7082	BPR5EY-11	6937	.044
1989	L4 2.3L		<b>BPR6ES-11</b>	<b>7133</b>			BPR6EIX-11	3903	BPR6EGP	7084	BPR6EY-11	6261	.040
	L4 2.6L		<b>BPR5ES-11</b>	<b>7634</b>			BPR5EIX-11	2115	BPR5EGP	7082	BPR5EY-11	6937	.044
<b>Ascender</b>													
2008-07	L6 4.2L		<b>ILTR5E11</b>	<b>91418</b>	LTR5AHX	90220	LTR5IX-11	4344	LTR5GP	5019			.044
2006-03	L6 4.2L		<b>ILTR5E11</b>	<b>91418</b>	LTR5AHX	90220	LTR5IX-11	4344	LTR5GP	5019			.044
	V8 5.3L		IZTR5B11	1465	TR5AHX	94567	TR5IX	7397	TR5GP	3186	TR5	2238	.040
<b>Axiom</b>													
2003-02	V6 3.5L		<b>PFR5G-11</b>	<b>2647</b>	FR5AHX	95839	BKR5EIX-11	5464	BKR5EGP	7090	BKR5EY-11	6745	.042
<b>Hombre</b>													
2000-98	L4 2.2L		PTR5D-10	3784			TR5IX	7397	TR5GP	3186	TR5	2238	.040
	V6 4.3L		<b>ITR4A15</b>	<b>5599</b>	TR5AHX	94567	TR5IX	7164	TR55GP	3403	TR55	3951	.060
1997	L4 2.2L		PZTR5A-15	7862			TR55-1IX	7316	TR55-1GP	7159	TR55-1	2683	.060
	V6 4.3L		<b>ITR4A15</b>	<b>5599</b>	TR5AHX	94567	TR5IX	7164	TR55GP	3403	TR55	3951	.060
1996	L4 2.2L		PZTR5A-15	7862			TR55-1IX	7316	TR55-1GP	7159	TR55-1	2683	.060
<b>i-280</b>													
2006	L4 2.8L		<b>ILTR5E11</b>	<b>91418</b>	LTR5AHX	90220	LTR5IX-11	4344	LTR5GP	5019			.044
<b>i-290</b>													
2008-07	L4 2.9L		<b>ILTR5E11</b>	<b>91418</b>	LTR5AHX	90220	LTR5IX-11	4344	LTR5GP	5019			.044
<b>i-350</b>													
2006	L5 3.5L		<b>ILTR5E11</b>	<b>91418</b>	LTR5AHX	90220	LTR5IX-11	4344	LTR5GP	5019			.044
<b>i-370</b>													
2008-07	L5 3.7L		<b>ILTR5E11</b>	<b>91418</b>	LTR5AHX	90220	LTR5IX-11	4344	LTR5GP	5019			.044
<b>I-Mark</b>													
1989	L4 1.5L		<b>BPR6ES-11</b>	<b>7133</b>			BPR6EIX-11	3903	BPR6EGP	7084	BPR6EY-11	6261	.044
	L4 1.6L		<b>BKR6E-11</b>	<b>2756</b>			BKR6EIX-11	3764	BKR6EGP	7092	BKR6E-11	2756	.044
1988-86	L4 1.5L		<b>BPR6ES-11</b>	<b>7133</b>			BPR6EIX-11	3903	BPR6EGP	7084	BPR6EY-11	6261	.044
1985	L4 1.5L		<b>BPR6ES-11</b>	<b>7133</b>			BPR6EIX-11	3903	BPR6EGP	7084	BPR6EY-11	6261	.044
	L4 1.8L		<b>BPR6ES-11</b>	<b>7133</b>			BPR6EIX-11	3903	BPR6EGP	7084	BPR6EY-11	6261	.044
<b>Impulse</b>													
1992	L4 1.6L		<b>BKR6E</b>	<b>6962</b>			BKR6EIX	6418	BKR6EGP	7092	BKR6E	6962	.030
	L4 1.8L		<b>BKR6E-11</b>	<b>2756</b>			BKR6EIX-11	3764	BKR6EGP	7092	BKR6E-11	2756	.044
1991	L4 1.6L	Naturally Aspirated	<b>BKR6E-11</b>	<b>2756</b>			BKR6EIX-11	3764	BKR6EGP	7092	BKR6E-11	2756	.044
		Turbo	<b>BKR6E</b>	<b>6962</b>			BKR6EIX	6418	BKR6EGP	7092	BKR6E	6962	.030
1990	L4 1.6L		<b>BKR6E-11</b>	<b>2756</b>			BKR6EIX-11	3764	BKR6EGP	7092	BKR6E-11	2756	.044
1989-88	L4 2.0L		<b>BPR6ES-11</b>	<b>7133</b>			BPR6EIX-11	3903	BPR6EGP	7084	BPR6EY-11	6261	.044
	L4 2.3L		<b>BPR6ES-11</b>	<b>7133</b>			BPR6EIX-11	3903	BPR6EGP	7084	BPR6EY-11	6261	.044
1987-85	L4 1.9L		<b>BPR6ES-11</b>	<b>7133</b>			BPR6EIX-11	3903	BPR6EGP	7084	BPR6EY-11	6261	.044
	L4 2.0L		<b>BPR6ES-11</b>	<b>7133</b>			BPR6EIX-11	3903	BPR6EGP	7084	BPR6EY-11	6261	.044
<b>Oasis</b>													
1999-98	L4 2.3L		<b>ZFR5F-11</b>	<b>2262</b>	FR5AHX	95839	ZFR5FIX-11	2477	ZFR5FGP	7098	ZFR5F-11	2262	.044
1997	L4 2.2L		<b>ZFR5F-11</b>	<b>2262</b>	FR5AHX	95839	ZFR5FIX-11	2477	ZFR5FGP	7098	ZFR5F-11	2262	.044
1996	L4 2.2L		<b>ZFR5F-11</b>	<b>2262</b>			ZFR5FIX-11	2477	ZFR5FGP	7098	ZFR5F-11	2262	.044
<b>Pickup</b>													
1995	L4 2.3L		<b>BPR5ES-11</b>	<b>7634</b>			BPR5EIX-11	2115	BPR5EGP	7082	BPR5EY-11	6937	.040





Year	Cyl. L	Notes	Original Equipment		Ruthenium HX		Iridium IX		G-Power		V-Power		Gap
			Part	Stock	Part	Stock	Part	Stock	Part	Stock	Part	Stock	
<b>ISUZU (Cont'd)</b>													
<b>Pickup (Cont'd)</b>													
1995	L4 2.6L		<b>BPR5ES-11</b>	<b>7634</b>			BPR5EIX-11	2115	BPR5EGP	7082	BPR5EY-11	6937	.040
1994-93	L4 2.3L		<b>BPR5ES-11</b>	<b>7634</b>			BPR5EIX-11	2115	BPR5EGP	7082	BPR5EY-11	6937	.040
	L4 2.6L		<b>BPR5ES-11</b>	<b>7634</b>			BPR5EIX-11	2115	BPR5EGP	7082	BPR5EY-11	6937	.040
	V6 3.1L		UR5	2771			UR5IX	7177	UR5GP	3547	UR5	2771	.044
1992	L4 2.3L		<b>BPR5ES-11</b>	<b>7634</b>			BPR5EIX-11	2115	BPR5EGP	7082	BPR5EY-11	6937	.040
	L4 2.6L		<b>BPR5ES-11</b>	<b>7634</b>			BPR5EIX-11	2115	BPR5EGP	7082	BPR5EY-11	6937	.044
	V6 3.1L		UR5	2771			UR5IX	7177	UR5GP	3547	UR5	2771	.044
1991	L4 2.3L		<b>BPR6ES-11</b>	<b>7133</b>			BPR6EIX-11	3903	BPR6EGP	7084	BPR6EY-11	6261	.044
	L4 2.6L		<b>BPR6ES-11</b>	<b>7133</b>			BPR6EIX-11	3903	BPR6EGP	7084	BPR6EY-11	6261	.044
	V6 3.1L		UR5	2771			UR5IX	7177	UR5GP	3547	UR5	2771	.044
1990-88	L4 2.3L		<b>BPR6ES-11</b>	<b>7133</b>			BPR6EIX-11	3903	BPR6EGP	7084	BPR6EY-11	6261	.044
	L4 2.6L		<b>BPR6ES-11</b>	<b>7133</b>			BPR6EIX-11	3903	BPR6EGP	7084	BPR6EY-11	6261	.044
1987-86	L4 1.9L		<b>BPR6ES-11</b>	<b>7133</b>			BPR6EIX-11	3903	BPR6EGP	7084	BPR6EY-11	6261	.044
	L4 2.2L	DIESEL	<b>Y-306R</b>	<b>6244</b>									
	L4 2.3L		<b>BPR6ES-11</b>	<b>7133</b>			BPR6EIX-11	3903	BPR6EGP	7084	BPR6EY-11	6261	.044
1985	L4 1.9L		<b>BPR6ES-11</b>	<b>7133</b>			BPR6EIX-11	3903	BPR6EGP	7084	BPR6EY-11	6261	.044
	L4 2.2L	DIESEL	<b>Y-306R</b>	<b>6244</b>									
<b>Rodeo</b>													
2004	V6 3.2L		<b>PFR5G-11</b>	<b>2647</b>	FR5AHX	95839	BKR5EIX-11	5464	BKR5EGP	7090	BKR5E-11	6953	.042
2003	L4 2.2L		<b>BKR6E-11</b>	<b>2756</b>	FR6BHX-S	95159	BKR6EIX-11	3764	BKR6EGP	7092	BKR6E-11	2756	.040
	V6 3.2L		<b>PFR5G-11</b>	<b>2647</b>	FR5AHX	95839	BKR5EIX-11	5464	BKR5EGP	7090	BKR5E-11	6953	.042
2002-01	L4 2.2L		PFR5G-11	2647	FR5BHX	96457	BKR5EIX-11	5464	BKR5EGP	7090	BKR5EY-11	6745	.040
	V6 3.2L		PFR5G-11	2647	FR5AHX	95839	BKR5EIX-11	5464	BKR5EGP	7090	BKR5EY-11	6745	.040
2000-98	L4 2.2L		PFR5G-11	2647	FR5BHX	96457	BKR5EIX-11	5464	BKR5EGP	7090	BKR5EY-11	6745	.042
	V6 3.2L		<b>PFR5G-11</b>	<b>2647</b>	FR5AHX	95839	BKR5EIX-11	5464	BKR5EGP	7090	BKR5EY-11	6745	.042
1997	L4 2.6L		<b>BPR5ES-11</b>	<b>7634</b>			BPR5EIX-11	2115	BPR5EGP	7082	BPR5EY-11	6937	.042
	V6 3.2L		<b>PFR5G-11</b>	<b>2647</b>	FR5AHX	95839	BKR5EIX-11	5464	BKR5EGP	7090	BKR5EY-11	6745	.042
1996	L4 2.6L		<b>BPR5ES-11</b>	<b>7634</b>			BPR5EIX-11	2115	BPR5EGP	7082	BPR5EY-11	6937	.042
	V6 3.2L		<b>PFR5G-11</b>	<b>2647</b>			BKR5EIX-11	5464	BKR5EGP	7090	BKR5EY-11	6745	.042
1995-93	L4 2.6L		<b>BPR5ES-11</b>	<b>7634</b>			BPR5EIX-11	2115	BPR5EGP	7082	BPR5EY-11	6937	.044
	V6 3.2L		<b>BKR6E-11</b>	<b>2756</b>			BKR6EIX-11	3764	BKR6EGP	7092	BKR6E-11	2756	.040
1992-91	L4 2.6L		<b>BPR5ES-11</b>	<b>7634</b>			BPR5EIX-11	2115	BPR5EGP	7082	BPR5EY-11	6937	.044
	V6 3.1L		UR5	2771			UR5IX	7177	UR5GP	3547	UR5	2771	.044
<b>Rodeo Sport</b>													
2003	L4 2.2L		<b>BKR6E-11</b>	<b>2756</b>	FR6BHX-S	95159	BKR6EIX-11	3764	BKR6EGP	7092	BKR6E-11	2756	.040
	V6 3.2L		<b>PFR5G-11</b>	<b>2647</b>	FR5AHX	95839	BKR5EIX-11	5464	BKR5EGP	7090	BKR5E-11	6953	.042
2002	L4 2.2L		PFR5G-11	2647	FR5BHX	96457	BKR5EIX-11	5464	BKR5EGP	7090	BKR5EY-11	6745	.040
	V6 3.2L		<b>PFR5G-11</b>	<b>2647</b>	FR5AHX	95839	BKR5EIX-11	5464	BKR5EGP	7090	BKR5EY-11	6745	.040
2001	L4 2.2L		PFR5G-11	2647	FR5BHX	96457	BKR5EIX-11	5464	BKR5EGP	7090	BKR5EY-11	6745	.040
	V6 3.2L		PFR5G-11	2647	FR5AHX	95839	BKR5EIX-11	5464	BKR5EGP	7090	BKR5EY-11	6745	.040
<b>Stylus</b>													
1993	L4 1.6L		<b>BPR6ES-11</b>	<b>7133</b>			BPR6EIX-11	3903	BPR6EGP	7084	BPR6EY-11	6261	.044
1992	L4 1.6L		<b>BKR6E-11</b>	<b>2756</b>			BKR6EIX-11	3764	BKR6EGP	7092	BKR6E-11	2756	.044
	L4 1.8L		<b>BPR6ES-11</b>	<b>7133</b>			BPR6EIX-11	3903	BPR6EGP	7084	BPR6EY-11	6261	.044
1991	L4 1.6L	Vin 5	<b>BKR6E-11</b>	<b>2756</b>			BKR6EIX-11	3764	BKR6EGP	7092	BKR6E-11	2756	.044
		Vin 6	<b>BPR6ES-11</b>	<b>7133</b>			BPR6EIX-11	3903	BPR6EGP	7084	BPR6EY-11	6261	.044
<b>Trooper</b>													
2002-98	V6 3.5L		<b>PFR5G-11</b>	<b>2647</b>	FR5AHX	95839	BKR5EIX-11	5464	BKR5EGP	7090	BKR5EY-11	6745	.042
1997	V6 3.2L		<b>PFR5G-11</b>	<b>2647</b>	FR5AHX	95839	BKR5EIX-11	5464	BKR5EGP	7090	BKR5EY-11	6745	.042
1996	V6 3.2L	LS	<b>PFR5G-11</b>	<b>2647</b>			BKR5EIX-11	5464	BKR5EGP	7090	BKR5EY-11	6745	.042
		S	<b>PFR5G-11</b>	<b>2647</b>			BKR5EIX-11	5464	BKR5EGP	7090	BKR5EY-11	6745	.050
		SE	<b>PFR5G-11</b>	<b>2647</b>			BKR5EIX-11	5464	BKR5EGP	7090	BKR5EY-11	6745	.042
1995-92	V6 3.2L		<b>BKR6E-11</b>	<b>2756</b>			BKR6EIX-11	3764	BKR6EGP	7092	BKR6E-11	2756	.044
1991-89	L4 2.6L		<b>BPR5ES-11</b>	<b>7634</b>			BPR5EIX-11	2115	BPR5EGP	7082	BPR5EY-11	6937	.040
	V6 2.8L		UR5	2771			UR5IX	7177	UR5GP	3547	UR5	2771	.044
1988	L4 2.6L		<b>BPR5ES-11</b>	<b>7634</b>			BPR5EIX-11	2115	BPR5EGP	7082	BPR5EY-11	6937	.040
1987-86	L4 2.2L	DIESEL	<b>Y-306R</b>	<b>6244</b>									

**Bold denotes NGK OE Manufacturer and/or OE Service Part**  
NOT BOLD denotes OE Equivalent Part

**Le texte en gras désigne une pièce d'équipement originale du manufacturier NGK et/ou pièce d'équipement originale de service**  
Le texte non en gras désigne une pièce d'équipement originale équivalente

Note: Due to different operating or engine conditions, alternate heat range plugs may be required.

Note: En raison de différences au niveau du fonctionnement ou des conditions du moteur, d'autres types de bougies avec variation de chaleur peuvent être nécessaires



Year	Cyl. L	Notes	Original Equipment		Ruthenium HX		Iridium IX		G-Power		V-Power		Gap
			Part	Stock	Part	Stock	Part	Stock	Part	Stock	Part	Stock	
<b>ISUZU (Cont'd)</b>													
Trooper (Cont'd)													
1987-86	L4 2.3L		<b>BPR6ES-11</b>	<b>7133</b>			BPR6EIX-11	3903	BPR6EGP	7084	BPR6EY-11	6261	.044
1985	L4 1.9L		<b>BPR6ES-11</b>	<b>7133</b>			BPR6EIX-11	3903	BPR6EGP	7084	BPR6EY-11	6261	.044
VehiCROSS													
2001-99	V6 3.5L		<b>PFR5G-11</b>	<b>2647</b>	FR5AHX	95839	BKR5EIX-11	5464	BKR5EGP	7090	BKR5EY-11	6745	.042
<b>JAGUAR</b>													
F-Pace													
2017	V6 3.0L		<b>SILZKAR7E8S</b>	<b>93476</b>									.032
F-Type													
2017-14	V6 3.0L		<b>SILZKAR7E8S</b>	<b>93476</b>									.032
	V8 5.0L		<b>ILKAR7C10</b>	<b>94940</b>									.040
S-Type													
2008	V6 3.0L		<b>TR6AP-13E</b>	<b>4968</b>									.050
	V8 4.2L		<b>IFR5N10</b>	<b>7866</b>	FR5BHX	96457	BKR5EIX-11	5464	BKR5EGP	7090	BKR5E	7938	.040
2007	V6 3.0L		<b>TR6AP-13E</b>	<b>4968</b>									.050
	V8 4.2L		<b>IFR5N10</b>	<b>7866</b>	FR5BHX	96457	BKR5EIX-11	5464	BKR5EGP	7090	BKR5E-11	6953	.040
2006-04	V6 3.0L		<b>TR6AP-13E</b>	<b>4968</b>									.050
	V8 4.2L		PFR5G-11	2647	FR5BHX	96457	BKR5EIX-11	5464	BKR5EGP	7090	BKR5E-11	6953	.040
2003	V6 3.0L		<b>TR6AP-13E</b>	<b>4968</b>									.050
	V8 4.2L		IFR5N10	7866	FR5BHX	96457	BKR5EIX-11	5464	BKR5EGP	7090	BKR5E-11	6953	.040
2002-00	V6 3.0L		<b>TR6AP-13E</b>	<b>4968</b>									.050
	V8 4.0L		<b>PFR5G-13E</b>	<b>2761</b>	FR5AHX	95839	BKR5EIX-11	5464	BKR5EGP	7090	BKR5E-11	6953	.052
Super V8													
2009-06	V8 4.2L		<b>IFR5N10</b>	<b>7866</b>	FR5BHX	96457	BKR5EIX-11	5464	BKR5EGP	7090	BKR5E	7938	.040
2005	V8 4.2L		PFR5G-11	2647	FR5BHX	96457	BKR5EIX-11	5464	BKR5EGP	7090	BKR5E-11	6953	.040
Vanden Plas													
2009-06	V8 4.2L		<b>IFR5N10</b>	<b>7866</b>	FR5BHX	96457	BKR5EIX-11	5464	BKR5EGP	7090	BKR5E	7938	.040
2005-04	V8 4.2L		PFR5G-11	2647	FR5AHX	95839	BKR5EIX-11	5464	BKR5EGP	7090	BKR5E-11	6953	.040
2003	V8 4.0L	Naturally Aspirated	<b>PFR5G-13E</b>	<b>2761</b>	FR5AHX	95839	BKR5EIX-11	5464	BKR5EGP	7090	BKR5E-11	6953	.052
		Supercharged	<b>PFR6G-13E</b>	<b>2341</b>	FR6BHX-S	95159	BKR6EIX-11	3764	BKR6EGP	7092	BKR6E-11	2756	.052
2002-00	V8 4.0L		<b>IFR5N10</b>	<b>7866</b>	FR5BHX	96457	BKR5EIX-11	5464	BKR5EGP	7090	BKR5E	7938	.040
1999-98	V8 4.0L		<b>PFR5G-13E</b>	<b>2761</b>	FR5AHX	95839	BKR5EIX-11	5464	BKR5EGP	7090	BKR5E-11	6953	.052
1997	L6 4.0L		<b>PFR5G-13E</b>	<b>2761</b>	FR5AHX	95839	BKR5EIX-11	5464	BKR5EGP	7090	BKR5E-11	6953	.052
1996-90	L6 4.0L		BKR6E	6962			BKR6EIX	6418	BKR6EGP	7092	BKR6E	6962	.035
1989-88	L6 3.6L		BKR6E	6962			BKR6EIX	6418	BKR6EGP	7092	BKR6E	6962	.028
1987-85	L6 4.2L		BPR5ES	7734			BPR5EIX	6597	BPR5EGP	7082	BPR5EY	1233	.035
XE													
2017	L4 2.0L	GAS	<b>ILTR6G8G</b>	<b>96621</b>	LTR6BHX	90495	LTR6IX	94374	LTR6GP-8	94372			.032
	V6 3.0L		<b>SILZKAR7E8S</b>	<b>93476</b>									.032
XF													
2017-16	V6 3.0L		<b>SILZKAR7E8S</b>	<b>93476</b>									.032
2015-13	L4 2.0L		<b>ILTR6G8G</b>	<b>96621</b>	LTR6BHX	90495	LTR6IX	94374	LTR6GP-8	94372			.032
	V6 3.0L		<b>SILZKAR7E8S</b>	<b>93476</b>									.032
	V8 5.0L		<b>ILKAR7C10</b>	<b>94940</b>									.040
	V8 5.0L		<b>ILKAR7C10</b>	<b>94940</b>									.040
2012-11	V8 5.0L		<b>ILKAR7C10</b>	<b>94940</b>									.040
2010	V8 4.2L		<b>IFR5N10</b>	<b>7866</b>	FR5AHX	95839	BKR5EIX-11	5464	BKR5EGP	7090	BKR5E	7938	.040
	V8 5.0L		<b>ILKAR7C10</b>	<b>94940</b>									.040
2009	V8 4.2L		<b>IFR5N10</b>	<b>7866</b>	FR5BHX	96457	BKR5EIX-11	5464	BKR5EGP	7090	BKR5E	7938	.040
XFR													
2015-10	V8 5.0L		<b>ILKAR7C10</b>	<b>94940</b>									.040
XFR-S													
2015-13	V8 5.0L		<b>ILKAR7C10</b>	<b>94940</b>									.040
XJ													
2016-13	V6 3.0L		<b>SILZKAR7E8S</b>	<b>93476</b>									.032
	V8 5.0L		<b>ILKAR7C10</b>	<b>94940</b>									.040
2012-10	V8 5.0L		<b>ILKAR7C10</b>	<b>94940</b>									.040
XJ6													
1997	L6 4.0L		BKR6E	6962	FR6AHX-S	94279	BKR6EIX	6418	BKR6EGP	7092	BKR6E	6962	.038



Year	Cyl. L	Notes	Original Equipment		Ruthenium HX		Iridium IX		G-Power		V-Power		Gap
			Part	Stock	Part	Stock	Part	Stock	Part	Stock	Part	Stock	
<b>JAGUAR (Cont'd)</b>													
<b>XJ6 (Cont'd)</b>													
1996-90	L6 4.0L		BKR6E	6962			BKR6EIX	6418	BKR6EGP	7092	BKR6E	6962	.035
1989-88	L6 3.6L		BKR6E	6962			BKR6EIX	6418	BKR6EGP	7092	BKR6E	6962	.028
1987	L6 3.6L		BKR6E	6962			BKR6EIX	6418	BKR6EGP	7092	BKR6E	6962	.028
	L6 4.2L		BPR5ES	7734			BPR5EIX	6597	BPR5EGP	7082	BPR5EY	1233	.035
1986-85	L6 4.2L		BPR5ES	7734			BPR5EIX	6597	BPR5EGP	7082	BPR5EY	1233	.035
<b>XJ8</b>													
2009-08	V8 4.2L		<b>IFR5N10</b>	<b>7866</b>	FR5AHX	95839	BKR5EIX-11	5464	BKR5EGP	7090	BKR5E	7938	.040
2007	V8 4.2L		IFR5N10	7866	FR5AHX	95839	BKR5EIX-11	5464	BKR5EGP	7090	BKR5E-11	6953	.040
2006-04	V8 4.2L		PFR5G-11	2647	FR5AHX	95839	BKR5EIX-11	5464	BKR5EGP	7090	BKR5E-11	6953	.040
2003	V8 4.0L		<b>PFR5G-13E</b>	<b>2761</b>	FR5AHX	95839	BKR5EIX-11	5464	BKR5EGP	7090	BKR5E-11	6953	.052
2002-00	V8 4.0L		<b>IFR5N10</b>	<b>7866</b>	FR5AHX	95839	BKR5EIX-11	5464	BKR5EGP	7090	BKR5E	7938	.040
1999-98	V8 4.0L		<b>PFR5G-13E</b>	<b>2761</b>	FR5AHX	95839	BKR5EIX-11	5464	BKR5EGP	7090	BKR5E-11	6953	.052
<b>XJ12</b>													
1996-94	V12 6.0L		BR6EF	3177							BR6EF	3177	.035
1992-91	V12 5.3L		BR7EF	3346							BR7EF	3346	.035
1990-89	V12 5.3L		BR7EFS	1094									.035
1988-85	V12 5.3L		TR5	2238			TR5IX	7397	TR5GP	3186	TR5	2238	.025
<b>XJR</b>													
2016-14	V8 5.0L		<b>ILKAR7C10</b>	<b>94940</b>									.040
2009-07	V8 4.2L		<b>IFR5N10</b>	<b>7866</b>	FR5BHX	96457	BKR5EIX-11	5464	BKR5EGP	7090	BKR5E	7938	.040
2006-04	V8 4.2L		PFR5G-11	2647	FR5BHX	96457	BKR5EIX-11	5464	BKR5EGP	7090	BKR5E-11	6953	.040
2003-98	V8 4.0L		<b>PFR6G-13E</b>	<b>2341</b>	FR6BHX-S	95159	BKR6EIX-11	3764	BKR6EGP	7092	BKR6E-11	2756	.052
1997	L6 4.0L		BKR5E	7938	FR5BHX	96457	BKR5EIX	6341	BKR5EGP	7090	BKR5E	7938	.038
1996-95	L6 4.0L		BKR6E	6962			BKR6EIX	6418	BKR6EGP	7092	BKR6E	6962	.035
<b>XJRS</b>													
1993	V12 6.0L		BR6EF	3177							BR6EF	3177	.035
<b>XJS</b>													
1996	L6 4.0L		BKR6E	6962			BKR6EIX	6418	BKR6EGP	7092	BKR6E	6962	.035
1995	L6 4.0L		BKR6E	6962			BKR6EIX	6418	BKR6EGP	7092	BKR6E	6962	.035
	V12 6.0L		BR6EF	3177							BR6EF	3177	.035
1994	L6 4.0L		BKR6E	6962			BKR6EIX	6418	BKR6EGP	7092	BKR6E	6962	.035
	V12 6.0L		BR7EF	3346							BR7EF	3346	.035
1993	L6 4.0L		BKR6E	6962			BKR6EIX	6418	BKR6EGP	7092	BKR6E	6962	.035
1992	L6 4.0L		BKR6E	6962			BKR6EIX	6418	BKR6EGP	7092	BKR6E	6962	.035
	V12 5.3L		BR7EF	3346							BR7EF	3346	.035
1991	V12 5.3L		BR7EF	3346							BR7EF	3346	.035
1990-89	V12 5.3L		BR7EFS	1094									.035
1988-85	V12 5.3L		TR5	2238			TR5IX	7397	TR5GP	3186	TR5	2238	.025
<b>XK</b>													
2015-10	V8 5.0L		<b>ILKAR7C10</b>	<b>94940</b>									.040
2009-07	V8 4.2L		<b>IFR5N10</b>	<b>7866</b>	FR5AHX	95839	BKR5EIX-11	5464	BKR5EGP	7090	BKR5E	7938	.040
<b>XK8</b>													
2006-04	V8 4.2L		PFR5G-11	2647	FR5AHX	95839	BKR5EIX-11	5464	BKR5EGP	7090	BKR5E-11	6953	.040
2003	V8 4.2L		IFR5N10	7866	FR5AHX	95839	BKR5EIX-11	5464	BKR5EGP	7090	BKR5E-11	6953	.040
2002-00	V8 4.0L		<b>IFR5N10</b>	<b>7866</b>	FR5AHX	95839	BKR5EIX-11	5464	BKR5EGP	7090	BKR5E	7938	.040
1999-97	V8 4.0L		<b>PFR5G-13E</b>	<b>2761</b>	FR5AHX	95839	BKR5EIX-11	5464	BKR5EGP	7090	BKR5E-11	6953	.052
<b>XKR</b>													
2015-10	V8 5.0L		<b>ILKAR7C10</b>	<b>94940</b>									.040
2009-07	V8 4.2L		<b>IFR5N10</b>	<b>7866</b>	FR5BHX	96457	BKR5EIX-11	5464	BKR5EGP	7090	BKR5E	7938	.040
2006-04	V8 4.2L		PFR5G-11	2647	FR5BHX	96457	BKR5EIX-11	5464	BKR5EGP	7090	BKR5E-11	6953	.040
2003	V8 4.2L		<b>PFR6G-13E</b>	<b>2341</b>	FR6BHX-S	95159	BKR6EIX-11	3764	BKR6EGP	7092	BKR6E-11	2756	.052
2002-00	V8 4.0L		<b>IFR5N10</b>	<b>7866</b>	FR5BHX	96457	BKR5EIX-11	5464	BKR5EGP	7090	BKR5E	7938	.040
<b>XKR-S</b>													
2015-12	V8 5.0L		<b>ILKAR7C10</b>	<b>94940</b>									.040
<b>X-Type</b>													
2008-06	V6 3.0L		<b>TR6AP-13E</b>	<b>4968</b>									.050
2005-02	V6 2.5L		PTR6D-13	5598	TR6AHX	92714	TR65IX	3692	TR6GP	5141	TR6	4177	.052

**Bold denotes NGK OE Manufacturer and/or OE Service Part**  
NOT BOLD denotes OE Equivalent Part

**Le texte en gras désigne une pièce d'équipement originale du manufacturier NGK et/ou pièce d'équipement originale de service**  
Le texte non en gras désigne une pièce d'équipement originale équivalente

Note: Due to different operating or engine conditions, alternate heat range plugs may be required.

Note: En raison de différences au niveau du fonctionnement ou des conditions du moteur, d'autres types de bougies avec variation de chaleur peuvent être nécessaires



Year	Cyl. L	Notes	Original Equipment		Ruthenium HX		Iridium IX		G-Power		V-Power		Gap
			Part	Stock	Part	Stock	Part	Stock	Part	Stock	Part	Stock	
<b>JAGUAR (Cont'd)</b>													
<b>X-Type (Cont'd)</b>													
2005-02	V6 3.0L		<b>TR6AP-13E</b>	<b>4968</b>									.050
<b>JEEP</b>													
<b>Cherokee</b>													
2017-14	L4 2.4L		LZFR5CI-11	92145	LFR5AHX	96355	LFR5AIX-11	4469	LFR5AGP	5018			.047
	V6 3.2L		SILZKR7B11	9723	LKR7BHX	94705	LKR7DIX-11S	93175	LKR7BGP-S	97390			.044
2001	L6 4.0L		ZFR5N	3459							ZFR5N	3459	.035
2000-99	L4 2.5L		FR5-1	7252							FR5-1	7252	.035
	L6 4.0L		ZFR5N	3459							ZFR5N	3459	.035
1998-91	L4 2.5L		FR5-1	7252							FR5-1	7252	.035
	L6 4.0L		FR5-1	7252							FR5-1	7252	.035
1990-87	L4 2.5L		FR5-1	7252							FR5-1	7252	.035
	L6 4.0L		BKR5E	7938			BKR5EIX	6341	BKR5EGP	7090	BKR5E	7938	.035
1986	L4 2.5L		FR5-1	7252							FR5-1	7252	.035
	V6 2.8L		UR5	2771			UR5IX	7177	UR5GP	3547	UR5	2771	.045
1985	L4 2.5L		ZFR5A-11	5084							ZFR5A-11	5084	.035
	V6 2.8L		UR5	2771			UR5IX	7177	UR5GP	3547	UR5	2771	.045
<b>CJ7</b>													
1986-85	L4 2.5L		ZFR5A-11	5084							ZFR5A-11	5084	.035
	L6 4.2L		ZFR5A-11	5084							ZFR5A-11	5084	.035
<b>Comanche</b>													
1992-91	L4 2.5L		FR5-1	7252							FR5-1	7252	.035
	L6 4.0L		FR5-1	7252							FR5-1	7252	.035
1990-87	L4 2.5L		FR5-1	7252							FR5-1	7252	.035
	L6 4.0L		BKR5E	7938			BKR5EIX	6341	BKR5EGP	7090	BKR5E	7938	.035
1986	L4 2.5L		FR5-1	7252							FR5-1	7252	.035
	V6 2.8L		UR5	2771			UR5IX	7177	UR5GP	3547	UR5	2771	.045
<b>Commander</b>													
2010	V6 3.7L		<b>ZFR6F-11G</b>	<b>6987</b>	FR6BHX-S	95159	ZFR6FIX-11	6441	ZFR6FGP	7100	ZFR6F-11G	6987	.044
	V8 5.7L	Dual Plug; 16 Req'd	<b>LZFR5C-11</b>	<b>92174</b>	LFR5AHX	96355	LFR5AIX-11	4469	LFR5AGP	5018			.044
2009	V6 3.7L		<b>ZFR6F-11G</b>	<b>6987</b>	FR6BHX-S	95159	ZFR6FIX-11	6441	ZFR6FGP	7100	ZFR6F-11G	6987	.044
	V8 4.7L	Dual Plug; Exhaust Side (8 Req'd)	PLZFR5B13EG	97606			LZFR5AIX-11E	92460	LZFR5AGP-E	90192			.051
		Dual Plug; Intake Side (8 Req'd)	LZFR5C-11	92174			LFR5AIX-11	4469	LFR5AGP	5018			.039
	V8 5.7L	Dual Plug; 16 Req'd	<b>LZFR5C-11</b>	<b>92174</b>	LFR5AHX	96355	LFR5AIX-11	4469	LFR5AGP	5018			.044
2008	V6 3.7L		<b>ZFR6F-11G</b>	<b>6987</b>	FR6AHX-S	94279	ZFR6FIX-11	6441	ZFR6FGP	7100	ZFR6F-11G	6987	.044
	V8 4.7L	Dual Plug; Exhaust Side (8 Req'd)	PLZFR5B13EG	97606			LZFR5AIX-11E	92460	LZFR5AGP-E	90192			.051
		Dual Plug; Intake Side (8 Req'd)	LZFR5C-11	92174			LFR5AIX-11	4469	LFR5AGP	5018			.039
	V8 5.7L	Dual Plug; 16 Req'd	LZTR4A-11	5306			LZTR4AIX-11	2313	LZTR4AGP	5017	LZTR4A-11	5306	.044
2007-06	V6 3.7L		<b>ZFR6F-11G</b>	<b>6987</b>	FR6AHX-S	94279	ZFR6FIX-11	6441	ZFR6FGP	7100	ZFR6F-11G	6987	.044
	V8 4.7L		ZFR6F-11G	6987	FR6AHX-S	94279	ZFR6FIX-11	6441	ZFR6FGP	7100	ZFR6F-11G	6987	.044
	V8 5.7L	Dual Plug; 16 Req'd	LZTR4A-11	5306			LZTR4AIX-11	2313	LZTR4AGP	5017	LZTR4A-11	5306	.044
<b>Compass</b>													
2017-10	L4 2.0L		<b>ZFR5F-11</b>	<b>2262</b>	FR5AHX	95839	ZFR5FIX-11	2477	ZFR5FGP	7098	ZFR5F-11	2262	.044
	L4 2.4L		<b>ZFR5F-11</b>	<b>2262</b>	FR5AHX	95839	ZFR5FIX-11	2477	ZFR5FGP	7098	ZFR5F-11	2262	.044
2009	L4 2.0L		<b>ZFR5F-11</b>	<b>2262</b>	FR5AHX	95839	ZFR5FIX-11	2477	ZFR5FGP	7098	ZFR5F-11	2262	.044
	L4 2.4L	Eng Desg ED3, Non-PZEV Eng.	<b>ZFR5F-11</b>	<b>2262</b>	FR5AHX	95839	ZFR5FIX-11	2477	ZFR5FGP	7098	ZFR5F-11	2262	.044
		PZEV, Eng Desg EDG	<b>ZFR5AP</b>	<b>92041</b>	FR5AHX-E	92375	ZFR5FIX-E	95332	ZFR5FGP-8E	92459			.032
2008-07	L4 2.0L		<b>ZFR5F-11</b>	<b>2262</b>	FR5AHX	95839	ZFR5FIX-11	2477	ZFR5FGP	7098	ZFR5F-11	2262	.044
	L4 2.4L		<b>ZFR5F-11</b>	<b>2262</b>	FR5AHX	95839	ZFR5FIX-11	2477	ZFR5FGP	7098	ZFR5F-11	2262	.044
<b>Grand Cherokee</b>													
2017-16	V6 3.6L		ILZKR7B11	7751	LKR7AHX-S	96358	LKR7DIX-11S	93175	LKR7BGP-S	97390			.040
	V8 5.7L	Dual Plug; 16 Req'd	<b>LZFR5CI-11</b>	<b>92145</b>	LFR5AHX	96355	LFR5AIX-11	4469	LFR5AGP	5018			.044
	V8 6.4L	Dual Plug; 16 Req'd	<b>LZTR6AP11EG</b>	<b>97408</b>									.044
2015-14	V6 3.6L		SILZKR7B11	9723	LKR7BHX	94705	LKR7DIX-11S	93175	LKR7BGP-S	97390			.044



Year	Cyl. L	Notes	Original Equipment		Ruthenium HX		Iridium IX		G-Power		V-Power		Gap
			Part	Stock	Part	Stock	Part	Stock	Part	Stock	Part	Stock	
<b>JEEP (Cont'd)</b>													
<b>Grand Cherokee (Cont'd)</b>													
2015-14	V8 5.7L	Dual Plug; 16 Req'd	<b>LZFR5CI-11</b>	<b>92145</b>	LFR5AHX	96355	LFR5AIX-11	4469	LFR5AGP	5018			.044
	V8 6.4L	Dual Plug; 16 Req'd	<b>LZTR6AP11EG</b>	<b>97408</b>									.044
2013-12	V6 3.6L		SILZKR7B11	9723	LKR7BHX	94705	LKR7DIX-11S	93175	LKR7BGP-S	97390			.044
	V8 5.7L	Dual Plug; 16 Req'd	<b>LZFR5C-11</b>	<b>92174</b>	LFR5AHX	96355	LFR5AIX-11	4469	LFR5AGP	5018			.044
	V8 6.4L	Dual Plug; 16 Req'd	<b>LZTR6AP11EG</b>	<b>97408</b>									.044
2011	V6 3.6L		SILZKR7B11	9723	LKR7BHX	94705	LKR7DIX-11S	93175	LKR7BGP-S	97390			.044
	V8 5.7L	Dual Plug; 16 Req'd	<b>LZFR5C-11</b>	<b>92174</b>	LFR5AHX	96355	LFR5AIX-11	4469	LFR5AGP	5018			.044
2010	V6 3.7L		<b>ZFR6F-11G</b>	<b>6987</b>	FR6BHX-S	95159	ZFR6FIX-11	6441	ZFR6FGP	7100	ZFR6F-11G	6987	.044
	V8 5.7L	Dual Plug; 16 Req'd	<b>LZFR5C-11</b>	<b>92174</b>	LFR5AHX	96355	LFR5AIX-11	4469	LFR5AGP	5018			.044
	V8 6.1L	Dual Plug; 16 Req'd	<b>PLZTR5A-13</b>	<b>4998</b>			LZTR5AIX-13	2314	LZTR5AGP	3381	LZTR5A-13	4306	.052
2009	V6 3.7L		<b>ZFR6F-11G</b>	<b>6987</b>	FR6BHX-S	95159	ZFR6FIX-11	6441	ZFR6FGP	7100	ZFR6F-11G	6987	.044
	V8 4.7L	Dual Plug; Exhaust Side (8 Req'd)	PLZFR5B13EG	97606			LZFR5AIX-11E	92460	LZFR5AGP-E	90192			.051
		Dual Plug; Intake Side (8 Req'd)	LZFR5C-11	92174			LFR5AIX-11	4469	LFR5AGP	5018			.039
	V8 5.7L	Dual Plug; 16 Req'd	<b>LZFR5C-11</b>	<b>92174</b>	LFR5AHX	96355	LFR5AIX-11	4469	LFR5AGP	5018			.044
2008	V8 6.1L	Dual Plug; 16 Req'd	<b>PLZTR5A-13</b>	<b>4998</b>			LZTR5AIX-13	2314	LZTR5AGP	3381	LZTR5A-13	4306	.052
	V6 3.7L		<b>ZFR6F-11G</b>	<b>6987</b>	FR6AHX-S	94279	ZFR6FIX-11	6441	ZFR6FGP	7100	ZFR6F-11G	6987	.044
	V8 4.7L	Dual Plug; Exhaust Side (8 Req'd)	PLZFR5B13EG	97606			LZFR5AIX-11E	92460	LZFR5AGP-E	90192			.051
		Dual Plug; Intake Side (8 Req'd)	LZFR5C-11	92174			LFR5AIX-11	4469	LFR5AGP	5018			.039
	V8 5.7L	Dual Plug; 16 Req'd	LZTR4A-11	5306			LZTR4AIX-11	2313	LZTR4AGP	5017	LZTR4A-11	5306	.044
2007-06	V8 6.1L	Dual Plug; 16 Req'd	<b>PLZTR5A-13</b>	<b>4998</b>			LZTR5AIX-13	2314	LZTR5AGP	3381	LZTR5A-13	4306	.052
	V6 3.7L		<b>ZFR6F-11G</b>	<b>6987</b>	FR6AHX-S	94279	ZFR6FIX-11	6441	ZFR6FGP	7100	ZFR6F-11G	6987	.044
	V8 4.7L		ZFR6F-11G	6987	FR6AHX-S	94279	ZFR6FIX-11	6441	ZFR6FGP	7100	ZFR6F-11G	6987	.044
	V8 5.7L	Dual Plug; 16 Req'd	LZTR4A-11	5306			LZTR4AIX-11	2313	LZTR4AGP	5017	LZTR4A-11	5306	.044
	V8 6.1L	Dual Plug; 16 Req'd	<b>PLZTR5A-13</b>	<b>4998</b>			LZTR5AIX-13	2314	LZTR5AGP	3381	LZTR5A-13	4306	.052
2005	V6 3.7L		<b>ZFR6F-11G</b>	<b>6987</b>	FR6AHX-S	94279	ZFR6FIX-11	6441	ZFR6FGP	7100	ZFR6F-11G	6987	.044
	V8 4.7L		ZFR6F-11G	6987	FR6AHX-S	94279	ZFR6FIX-11	6441	ZFR6FGP	7100	ZFR6F-11G	6987	.044
	V8 5.7L	Dual Plug; 16 Req'd	LZTR4A-11	5306			LZTR4AIX-11	2313	LZTR4AGP	5017	LZTR4A-11	5306	.044
2004-03	L6 4.0L		<b>ZFR5N</b>	<b>3459</b>							ZFR5N	3459	.036
	V8 4.7L	Vin J	PFR6T-10G	5542	FR6AHX-S	94279	BKR6EIX-11	3764	BKR6EGP	7092			.040
		Vin N	ZFR6F-11G	6987	FR6AHX-S	94279	ZFR6FIX-11	6441	ZFR6FGP	7100	ZFR6F-11G	6987	.044
2002	L6 4.0L		ZFR5N	3459							ZFR5N	3459	.035
	V8 4.7L	Vin J	PFR6T-10G	5542	FR6AHX-S	94279	BKR6EIX-11	3764	BKR6EGP	7092			.040
		Vin N	ZFR6F-11G	6987	FR6AHX-S	94279	ZFR6FIX-11	6441	ZFR6FGP	7100	ZFR6F-11G	6987	.044
2001-99	L6 4.0L		ZFR5N	3459							ZFR5N	3459	.035
	V8 4.7L		ZFR6F-11G	6987	FR6AHX-S	94279	ZFR6FIX-11	6441	ZFR6FGP	7100	ZFR6F-11G	6987	.044
1998	L6 4.0L		FR5-1	7252							FR5-1	7252	.035
	V8 5.2L		ZFR6F-11	4291	FR6AHX-S	94279	ZFR6FIX-11	6441	ZFR6FGP	7100	ZFR6F-11	4291	.040
	V8 5.9L		ZFR6F-11	4291	FR6AHX-S	94279	ZFR6FIX-11	6441	ZFR6FGP	7100	ZFR6F-11	4291	.040
1997	L6 4.0L		FR5-1	7252							FR5-1	7252	.035
	V8 5.2L		ZFR6F-11	4291	FR6AHX-S	94279	ZFR6FIX-11	6441	ZFR6FGP	7100	ZFR6F-11	4291	.040
1996	L6 4.0L		FR5-1	7252							FR5-1	7252	.035
	V8 5.2L		BKR5E	7938			BKR5EIX	6341	BKR5EGP	7090	BKR5E	7938	.035
1995-93	L6 4.0L		FR5-1	7252							FR5-1	7252	.035
	V8 5.2L		FR4	5155			BKR4EIX	5693	FR4GP	2685	FR4	5155	.035
<b>Grand Wagoneer</b>													
1993	V8 5.2L		FR4	5155			BKR4EIX	5693	FR4GP	2685	FR4	5155	.035
1991-87	V8 5.9L		GR4	2635			GR4IX	97382	GR4GP	2763	GR4	2635	.035
1986-85	L6 4.2L		ZFR5A-11	5084							ZFR5A-11	5084	.035
	V8 5.9L		GR4	2635			GR4IX	97382	GR4GP	2763	GR4	2635	.035
<b>J10</b>													
1988	V8 5.9L		GR4	2635			GR4IX	97382	GR4GP	2763	GR4	2635	.035
1987-85	L6 4.2L		ZFR5A-11	5084							ZFR5A-11	5084	.035
	V8 5.9L		GR4	2635			GR4IX	97382	GR4GP	2763	GR4	2635	.035

**Bold denotes NGK OE Manufacturer and/or OE Service Part**  
 NOT BOLD denotes OE Equivalent Part

Note: Due to different operating or engine conditions, alternate heat range plugs may be required.

**Le texte en gras désigne une pièce d'équipement originale du manufacturier NGK et/ou pièce d'équipement originale de service**  
 Le texte non en gras désigne une pièce d'équipement originale équivalente

Note: En raison de différences au niveau du fonctionnement ou des conditions du moteur, d'autres types de bougies avec variation de chaleur peuvent être nécessaires





Year	Cyl. L	Notes	Original Equipment		Ruthenium HX		Iridium IX		G-Power		V-Power		Gap
			Part	Stock	Part	Stock	Part	Stock	Part	Stock	Part	Stock	
<b>JEEP (Cont'd)</b>													
<b>J20</b>													
1988-85	V8 5.9L		GR4	2635			GR4IX	97382	GR4GP	2763	GR4	2635	.035
<b>Liberty</b>													
2012-09	V6 3.7L		<b>ZFR6F-11G</b>	<b>6987</b>	FR6BHX-S	95159	ZFR6FIX-11	6441	ZFR6FGP	7100	ZFR6F-11G	6987	.044
2008-06	V6 3.7L		<b>ZFR6F-11G</b>	<b>6987</b>	FR6AHX-S	94279	ZFR6FIX-11	6441	ZFR6FGP	7100	ZFR6F-11G	6987	.044
2005	L4 2.4L		LZTR4A-11	5306			LZTR4AIX-11	2313	LZTR4AGP	5017	LZTR4A-11	5306	.052
	V6 3.7L		<b>ZFR6F-11G</b>	<b>6987</b>	FR6AHX-S	94279	ZFR6FIX-11	6441	ZFR6FGP	7100	ZFR6F-11G	6987	.044
2004	L4 2.4L		<b>LZTR4A-11</b>	<b>5306</b>			LZTR4AIX-11	2313	LZTR4AGP	5017	LZTR4A-11	5306	.044
	V6 3.7L		<b>ZFR6F-11G</b>	<b>6987</b>	FR6AHX-S	94279	ZFR6FIX-11	6441	ZFR6FGP	7100	ZFR6F-11G	6987	.044
2003-02	L4 2.4L		LZTR4A-11	5306			LZTR4AIX-11	2313	LZTR4AGP	5017	LZTR4A-11	5306	.045
	V6 3.7L		<b>ZFR6F-11G</b>	<b>6987</b>	FR6AHX-S	94279	ZFR6FIX-11	6441	ZFR6FGP	7100	ZFR6F-11G	6987	.044
<b>Patriot</b>													
2017-10	L4 2.0L		<b>ZFR5F-11</b>	<b>2262</b>	FR5AHX	95839	ZFR5FIX-11	2477	ZFR5FGP	7098	ZFR5F-11	2262	.044
	L4 2.4L		<b>ZFR5F-11</b>	<b>2262</b>	FR5AHX	95839	ZFR5FIX-11	2477	ZFR5FGP	7098	ZFR5F-11	2262	.044
2009	L4 2.0L		<b>ZFR5F-11</b>	<b>2262</b>	FR5AHX	95839	ZFR5FIX-11	2477	ZFR5FGP	7098	ZFR5F-11	2262	.044
	L4 2.4L	Eng Desg ED3, Non-PZEV Eng. PZEV, Eng Desg EDG	<b>ZFR5F-11</b>	<b>2262</b>	FR5AHX	95839	ZFR5FIX-11	2477	ZFR5FGP	7098	ZFR5F-11	2262	.044
			<b>ZFR5AP</b>	<b>92041</b>	FR5AHX-E	92375	ZFR5FIX-E	95332	ZFR5FGP-8E	92459			.032
2008-07	L4 2.0L		<b>ZFR5F-11</b>	<b>2262</b>	FR5AHX	95839	ZFR5FIX-11	2477	ZFR5FGP	7098	ZFR5F-11	2262	.044
	L4 2.4L		<b>ZFR5F-11</b>	<b>2262</b>	FR5AHX	95839	ZFR5FIX-11	2477	ZFR5FGP	7098	ZFR5F-11	2262	.044
<b>Renegade</b>													
2017-15	L4 1.4L		<b>SIKR9A7</b>	<b>93618</b>									.028
	L4 2.4L		LZFR5CI-11	92145	LF5AHX	96355	LF5AIX-11	4469	LF5AGP	5018			.047
<b>Scrambler</b>													
1985	L4 2.5L		ZFR5A-11	5084							ZFR5A-11	5084	.035
	L6 4.2L		ZFR5A-11	5084							ZFR5A-11	5084	.035
<b>TJ</b>													
2006-05	L4 2.4L		LZTR4A-11	5306			LZTR4AIX-11	2313	LZTR4AGP	5017	LZTR4A-11	5306	.044
	L6 4.0L		<b>ZFR5N</b>	<b>3459</b>							ZFR5N	3459	.036
2004	L6 4.0L		<b>ZFR5N</b>	<b>3459</b>							ZFR5N	3459	.036
2003	L4 2.4L		LZTR4A-11	5306			LZTR4AIX-11	2313	LZTR4AGP	5017	LZTR4A-11	5306	.044
	L6 4.0L		<b>ZFR5N</b>	<b>3459</b>							ZFR5N	3459	.036
2002-97	L4 2.5L		ZFR5N	3459							ZFR5N	3459	.036
	L6 4.0L		ZFR5N	3459							ZFR5N	3459	.036
<b>Wagoneer</b>													
1990-88	L6 4.0L		BKR5E	7938			BKR5EIX	6341	BKR5EGP	7090	BKR5E	7938	.035
1987	L4 2.5L		FR5-1	7252							FR5-1	7252	.035
	L6 4.0L		BKR5E	7938			BKR5EIX	6341	BKR5EGP	7090	BKR5E	7938	.035
1986	L4 2.5L		FR5-1	7252							FR5-1	7252	.035
	V6 2.8L		UR5	2771			UR5IX	7177	UR5GP	3547	UR5	2771	.045
1985	L4 2.5L		ZFR5A-11	5084							ZFR5A-11	5084	.035
	V6 2.8L		UR5	2771			UR5IX	7177	UR5GP	3547	UR5	2771	.045
<b>Wrangler</b>													
2017-12	V6 3.6L		SILZKR7B11	9723	LKR7BHX	94705	LKR7DIX-11S	93175	LKR7BGP-S	97390			.044
2011-07	V6 3.8L		PLZTR5A-13	4998			LZTR5AIX-13	2314	LZTR5AGP	3381	LZTR5A-13	4306	.050
2006-03	L4 2.4L		LZTR4A-11	5306			LZTR4AIX-11	2313	LZTR4AGP	5017	LZTR4A-11	5306	.044
	L6 4.0L		<b>ZFR5N</b>	<b>3459</b>							ZFR5N	3459	.036
2002-99	L4 2.5L		FR5-1	7252							FR5-1	7252	.035
	L6 4.0L		ZFR5N	3459							ZFR5N	3459	.035
1998-97	L4 2.5L		FR5-1	7252							FR5-1	7252	.035
	L6 4.0L		FR5-1	7252							FR5-1	7252	.035
1995-91	L4 2.5L		FR5-1	7252							FR5-1	7252	.035
	L6 4.0L		FR5-1	7252							FR5-1	7252	.035
1990-87	L4 2.5L		FR5-1	7252							FR5-1	7252	.035
	L6 4.2L		ZFR5A-11	5084							ZFR5A-11	5084	.035



Year	Cyl. L	Notes	Original Equipment		Ruthenium HX		Iridium IX		G-Power		V-Power		Gap
			Part	Stock	Part	Stock	Part	Stock	Part	Stock	Part	Stock	
<b>KIA</b>													
<b>Amanti</b>													
2009-07	V6 3.8L		<b>IFR5G11</b>	<b>7854</b>	FR5AHX	95839	BKR5EIX-11	5464	BKR5EGP	7090	BKR5E	7938	.044
2006-04	V6 3.5L		<b>PFR5N-11</b>	<b>5838</b>	FR5BHX	96457	BKR5EIX-11	5464	BKR5EGP	7090	BKR5E-11	6953	.044
<b>Borrego</b>													
2011-10	V6 3.8L		<b>SILZKR6B11</b>	<b>6215</b>	LKR6AHX	91356							.044
	V8 4.6L		<b>DILFR5E11</b>	<b>92605</b>	LFR5AHX	96355	LFR5AIX-11	4469	LFR5AGP	5018			.044
2009	V6 3.8L	From 5/16/2008	<b>SILZKR6B11</b>	<b>6215</b>	LKR6AHX	91356							.044
		To 5/15/2008	<b>ILFR5B11</b>	<b>1637</b>	LFR5AHX	96355	LFR5AIX-11	4469	LFR5AGP	5018	LFR5A-11	6376	.044
	V8 4.6L		<b>DILFR5E11</b>	<b>92605</b>	LFR5AHX	96355	LFR5AIX-11	4469	LFR5AGP	5018			.044
<b>Cadenza</b>													
2017-14	V6 3.3L		<b>SILZKR7B11</b>	<b>9723</b>	LKR7BHX	94705	LKR7DIX-11S	93175	LKR7BGP-S	97390			.044
<b>Forte</b>													
2017	L4 2.0L		<b>SILZKR7B11</b>	<b>9723</b>	LKR7BHX	94705	LKR7DIX-11S	93175	LKR7BGP-S	97390			.044
2016-14	L4 1.8L		<b>SILZKR7B11</b>	<b>9723</b>	LKR7BHX	94705	LKR7DIX-11S	93175	LKR7BGP-S	97390			.044
	L4 2.0L		<b>SILZKR7B11</b>	<b>9723</b>	LKR7BHX	94705	LKR7DIX-11S	93175	LKR7BGP-S	97390			.044
2013-10	L4 2.0L		DILFR5A-11D	98376	LFR5AHX	96355	LFR5AIX-11	4469	LFR5AGP	5018			.044
	L4 2.4L		DILFR5A-11D	98376	LFR5AHX	96355	LFR5AIX-11	4469	LFR5AGP	5018			.044
<b>Forte5</b>													
2017	L4 2.0L		<b>SILZKR7B11</b>	<b>9723</b>	LKR7BHX	94705	LKR7DIX-11S	93175	LKR7BGP-S	97390			.044
2016-14	L4 1.6L	w/OE # 18846-08060 (SILZKR6D-8E)	<b>SILZKR6D8E</b>	<b>91568</b>	LKR6BHX-E	93763	LKR6CIX	93126	LKR6BGP-E	96002			.032
		w/OE # 18849-08071 (SILZKR7E8EG)	<b>SILZKR7E8EG</b>	<b>93655</b>									.032
	L4 2.0L		<b>SILZKR7B11</b>	<b>9723</b>	LKR7BHX	94705	LKR7DIX-11S	93175	LKR7BGP-S	97390			.044
2013-12	L4 2.0L		DILFR5A-11D	98376	LFR5AHX	96355	LFR5AIX-11	4469	LFR5AGP	5018			.044
	L4 2.4L		DILFR5A-11D	98376	LFR5AHX	96355	LFR5AIX-11	4469	LFR5AGP	5018			.044
<b>Forte Koup</b>													
2017	L4 2.0L		<b>SILZKR7B11</b>	<b>9723</b>	LKR7BHX	94705	LKR7DIX-11S	93175	LKR7BGP-S	97390			.044
2016-14	L4 1.6L	w/OE # 18846-08060 (SILZKR6D-8E)	<b>SILZKR6D8E</b>	<b>91568</b>	LKR6BHX-E	93763	LKR6CIX	93126	LKR6BGP-E	96002			.032
		w/OE # 18849-08071 (SILZKR7E8EG)	<b>SILZKR7E8EG</b>	<b>93655</b>									.032
	L4 2.0L		<b>SILZKR7B11</b>	<b>9723</b>	LKR7BHX	94705	LKR7DIX-11S	93175	LKR7BGP-S	97390			.044
2013-10	L4 2.0L		DILFR5A-11D	98376	LFR5AHX	96355	LFR5AIX-11	4469	LFR5AGP	5018			.044
	L4 2.4L		DILFR5A-11D	98376	LFR5AHX	96355	LFR5AIX-11	4469	LFR5AGP	5018			.044
<b>K900</b>													
2017-15	V6 3.8L		<b>DILKR7A11</b>	<b>93135</b>	LKR7AHX-S	96358	LKR7DIX-11S	93175	LKR7BGP-S	97390			.044
	V8 5.0L		<b>DILKR7A11</b>	<b>93135</b>	LKR7AHX-S	96358	LKR7DIX-11S	93175	LKR7BGP-S	97390			.044
<b>Magentis</b>													
2010-09	L4 2.4L		DILFR5A-11D	98376	LFR5AHX	96355	LFR5AIX-11	4469	LFR5AGP	5018			.044
	V6 2.7L		<b>ILFR5B11</b>	<b>1637</b>	LFR5AHX	96355	LFR5AIX-11	4469	LFR5AGP	5018	LFR5A-11	6376	.044
2008-07	L4 2.4L		IFR5E11	7994	FR5AHX	95839	BKR5EIX-11	5464	BKR5EGP	7090	BKR5E	7938	.044
	V6 2.7L		<b>ILFR5B11</b>	<b>1637</b>	LFR5AHX	96355	LFR5AIX-11	4469	LFR5AGP	5018	LFR5A-11	6376	.044
2006-02	L4 2.4L		<b>PGR5C-11</b>	<b>5760</b>			BPR5EIX-11	2115	BPR5EGP	7082	BPR5EY-11	6937	.044
	V6 2.7L		<b>PFR5N-11</b>	<b>5838</b>	FR5BHX	96457	BKR5EIX-11	5464	BKR5EGP	7090	BKR5E-11	6953	.044
2001	L4 2.4L		<b>PGR5C-11</b>	<b>5760</b>			BPR5EIX-11	2115	BPR5EGP	7082	BPR5EY-11	6937	.044
	V6 2.5L		<b>PFR5N-11</b>	<b>5838</b>	FR5BHX	96457	BKR5EIX-11	5464	BKR5EGP	7090	BKR5E-11	6953	.044
<b>Optima</b>													
2017	L4 2.4L		<b>SILZKR7E11</b>	<b>92315</b>	LKR7AHX-S	96358	LKR7DIX-11S	93175					.044
2016	L4 2.4L	GAS	<b>SILZKR7E11</b>	<b>92315</b>	LKR7AHX-S	96358	LKR7DIX-11S	93175					.044
2015-11	L4 2.4L	GAS	DILKR6C11	93199									.044
2010-09	L4 2.4L		DILFR5A-11D	98376	LFR5AHX	96355	LFR5AIX-11	4469	LFR5AGP	5018			.044
	V6 2.7L		<b>ILFR5B11</b>	<b>1637</b>	LFR5AHX	96355	LFR5AIX-11	4469	LFR5AGP	5018	LFR5A-11	6376	.044
2008-07	L4 2.4L		IFR5E11	7994	FR5AHX	95839	BKR5EIX-11	5464	BKR5EGP	7090	BKR5E	7938	.044
	V6 2.7L		<b>ILFR5B11</b>	<b>1637</b>	LFR5AHX	96355	LFR5AIX-11	4469	LFR5AGP	5018	LFR5A-11	6376	.044
2006	L4 2.4L	Vin 3	IFR5E11	7994	FR5AHX	95839	BKR5EIX-11	5464	BKR5EGP	7090	BKR5E-11	6953	.044
		Vin 6	<b>PGR5C-11</b>	<b>5760</b>			BPR5EIX-11	2115	BPR5EGP	7082	BPR5EY-11	6937	.044
	V6 2.7L	Vin 4	<b>ILFR5B11</b>	<b>1637</b>	LFR5AHX	96355	LFR5AIX-11	4469	LFR5AGP	5018	LFR5A-11	6376	.044
		Vin 8	<b>PFR5N-11</b>	<b>5838</b>	FR5BHX	96457	BKR5EIX-11	5464	BKR5EGP	7090	BKR5E-11	6953	.044

**Bold denotes NGK OE Manufacturer and/or OE Service Part**  
NOT BOLD denotes OE Equivalent Part

**Le texte en gras désigne une pièce d'équipement originale du manufacturier NGK et/ou pièce d'équipement originale de service**  
Le texte non en gras désigne une pièce d'équipement originale équivalente

Note: Due to different operating or engine conditions, alternate heat range plugs may be required.

Note: En raison de différences au niveau du fonctionnement ou des conditions du moteur, d'autres types de bougies avec variation de chaleur peuvent être nécessaires



Year	Cyl. L	Notes	Original Equipment		Ruthenium HX		Iridium IX		G-Power		V-Power		Gap
			Part	Stock	Part	Stock	Part	Stock	Part	Stock	Part	Stock	
<b>KIA (Cont'd)</b>													
<b>Optima (Cont'd)</b>													
2005-02	L4 2.4L		<b>PGR5C-11</b>	<b>5760</b>			BPR5EIX-11	2115	BPR5EGP	7082	BPR5EY-11	6937	.044
	V6 2.7L		<b>PFR5N-11</b>	<b>5838</b>	FR5BHX	96457	BKR5EIX-11	5464	BKR5EGP	7090	BKR5E-11	6953	.044
2001	L4 2.4L		<b>PGR5C-11</b>	<b>5760</b>			BPR5EIX-11	2115	BPR5EGP	7082	BPR5EY-11	6937	.044
	V6 2.5L		<b>PFR5N-11</b>	<b>5838</b>	FR5BHX	96457	BKR5EIX-11	5464	BKR5EGP	7090	BKR5E-11	6953	.044
<b>Rio</b>													
2017-12	L4 1.6L		<b>SILZKR6B10E</b>	<b>93815</b>	LKR6BHX-E	93763	LZKR6AIX	92873	LZKR6AGP-E	94017			.040
2011-06	L4 1.6L		<b>BKR5ES-11</b>	<b>2382</b>	FR5AHX	95839	BKR5EIX-11	5464	BKR5EGP	7090	BKR5E-11	6953	.044
2005-03	L4 1.6L		<b>BKR6ES-11</b>	<b>5553</b>	FR6BHX-S	95159	BKR6EIX-11	3764	BKR6EGP	7092	BKR6E-11	2756	.044
2002-01	L4 1.5L		<b>BKR6E</b>	<b>6962</b>	FR6BHX-S	95159	BKR6EIX	6418	BKR6EGP	7092	BKR6E	6962	.032
<b>Rio5</b>													
2011-06	L4 1.6L		<b>BKR5ES-11</b>	<b>2382</b>	FR5AHX	95839	BKR5EIX-11	5464	BKR5EGP	7090	BKR5E-11	6953	.044
<b>Rondo</b>													
2017-14	L4 2.0L		<b>SILZKR7B11</b>	<b>9723</b>	LKR7BHX	94705	LKR7DIX-11S	93175	LKR7BGP-S	97390			.044
2012-09	L4 2.4L		DILFR5A-11D	98376	LF5AHX	96355	LF5AIX-11	4469	LF5AGP	5018			.044
	V6 2.7L		<b>ILFR5B11</b>	<b>1637</b>	LF5AHX	96355	LF5AIX-11	4469	LF5AGP	5018	LF5A-11	6376	.044
2008-07	L4 2.4L		IFR5E11	7994	FR5AHX	95839	BKR5EIX-11	5464	BKR5EGP	7090	BKR5E-11	6953	.044
	V6 2.7L		<b>ILFR5B11</b>	<b>1637</b>	LF5AHX	96355	LF5AIX-11	4469	LF5AGP	5018	LF5A-11	6376	.044
<b>Sedona</b>													
2017-15	V6 3.3L		<b>SILZKR7B11</b>	<b>9723</b>	LKR7BHX	94705	LKR7DIX-11S	93175	LKR7BGP-S	97390			.044
2014	V6 3.5L	118.9(WheelBase), LWB; North American Spec.	<b>IFR5G11</b>	<b>7854</b>	FR5AHX	95839	BKR5EIX-11	5464	BKR5EGP	7090	BKR5E-11	6953	.044
		SWB; Outside North America	<b>SILZKR7B11</b>	<b>9723</b>	LKR7BHX	94705	LKR7DIX-11S	93175	LKR7BGP-S	97390			.044
2012-11	V6 3.5L	118.9(WheelBase), LWB; North American Spec.	<b>IFR5G11</b>	<b>7854</b>	FR5AHX	95839	BKR5EIX-11	5464	BKR5EGP	7090	BKR5E-11	6953	.044
		SWB; Outside North America	<b>SILZKR7B11</b>	<b>9723</b>	LKR7BHX	94705	LKR7DIX-11S	93175	LKR7BGP-S	97390			.044
2010-06	V6 3.8L		<b>IFR5G11</b>	<b>7854</b>	FR5AHX	95839	BKR5EIX-11	5464	BKR5EGP	7090	BKR5E-11	6953	.044
2005-02	V6 3.5L		<b>PFR5N-11</b>	<b>5838</b>	FR5BHX	96457	BKR5EIX-11	5464	BKR5EGP	7090	BKR5E-11	6953	.044
<b>Sephia</b>													
2001-98	L4 1.8L		<b>BKR6E</b>	<b>6962</b>	FR6BHX-S	95159	BKR6EIX	6418	BKR6EGP	7092	BKR6E	6962	.032
1997	L4 1.6L		<b>BKR5E-11</b>	<b>6953</b>	FR5AHX	95839	BKR5EIX-11	5464	BKR5EGP	7090	BKR5E-11	6953	.044
	L4 1.8L		<b>BKR5ES-11</b>	<b>2382</b>	FR5AHX	95839	BKR5EIX-11	5464	BKR5EGP	7090	BKR5E-11	6953	.044
1996	L4 1.6L		<b>BKR5E-11</b>	<b>6953</b>			BKR5EIX-11	5464	BKR5EGP	7090	BKR5E-11	6953	.044
	L4 1.8L		<b>BKR5ES-11</b>	<b>2382</b>			BKR5EIX-11	5464	BKR5EGP	7090	BKR5E-11	6953	.044
1995	L4 1.6L	DOHC	<b>BKR5E-11</b>	<b>6953</b>			BKR5EIX-11	5464	BKR5EGP	7090	BKR5E-11	6953	.044
		SOHC	<b>BPR5ES-11</b>	<b>7634</b>			BPR5EIX-11	2115	BPR5EGP	7082	BPR5EY-11	6937	.044
	L4 1.8L		<b>BKR5ES-11</b>	<b>2382</b>			BKR5EIX-11	5464	BKR5EGP	7090	BKR5E-11	6953	.044
1994	L4 1.6L		<b>BPR5ES-11</b>	<b>7634</b>			BPR5EIX-11	2115	BPR5EGP	7082	BPR5EY-11	6937	.044
<b>Sorento</b>													
2017	L4 2.4L		<b>SILZKR7E11</b>	<b>92315</b>	LKR7AHX-S	96358	LKR7DIX-11S	93175					.044
	V6 3.3L		<b>SILZKR7B11</b>	<b>9723</b>	LKR7BHX	94705	LKR7DIX-11S	93175	LKR7BGP-S	97390			.044
2016	L4 2.0L	To 1/2/2015	<b>SILZKR7E9G</b>	<b>91467</b>			LKR7DIX-11S	93175					.036
	L4 2.4L		<b>SILZKR7E11</b>	<b>92315</b>	LKR7AHX-S	96358	LKR7DIX-11S	93175					.044
	V6 3.3L		<b>SILZKR7B11</b>	<b>9723</b>	LKR7BHX	94705	LKR7DIX-11S	93175	LKR7BGP-S	97390			.044
2015	L4 2.4L		<b>SILZKR7E11</b>	<b>92315</b>	LKR7AHX-S	96358	LKR7DIX-11S	93175					.044
	V6 3.3L		<b>SILZKR7B11</b>	<b>9723</b>	LKR7BHX	94705	LKR7DIX-11S	93175	LKR7BGP-S	97390			.044
2014	L4 2.4L		DILKR6C11	93199									.044
	V6 3.3L		<b>SILZKR7B11</b>	<b>9723</b>	LKR7BHX	94705	LKR7DIX-11S	93175	LKR7BGP-S	97390			.044
2013	L4 2.4L	Vin 1, MPI(FuelSystDesi.)	DILFR5A-11D	98376	LF5AHX	96355	LF5AIX-11	4469	LF5AGP	5018			.044
		Vin 6, DI(FuelSystDesi.)	DILKR6C11	93199									.044
	V6 3.5L		<b>SILZKR7B11</b>	<b>9723</b>	LKR7BHX	94705	LKR7DIX-11S	93175	LKR7BGP-S	97390			.044
2012	L4 2.4L	Vin 1, MPI(FuelSystDesi.)	DILFR5A-11D	98376	LF5AHX	96355	LF5AIX-11	4469	LF5AGP	5018			.044
		Vin 6, GDI(FuelSystDesi.)	DILKR6C11	93199									.044



Year	Cyl. L	Notes	Original Equipment		Ruthenium HX		Iridium IX		G-Power		V-Power		Gap
			Part	Stock	Part	Stock	Part	Stock	Part	Stock	Part	Stock	
<b>KIA (Cont'd)</b>													
<b>Sorento (Cont'd)</b>													
2012	V6 3.5L		<b>SILZKR7B11</b>	<b>9723</b>	LKR7BHX	94705	LKR7DIX-11S	93175	LKR7BGP-S	97390			.044
2011	L4 2.4L		DILFR5A-11D	98376	LF5AHX	96355	LF5AIX-11	4469	LF5AGP	5018			.044
	V6 3.5L		<b>SILZKR7B11</b>	<b>9723</b>	LKR7BHX	94705	LKR7DIX-11S	93175	LKR7BGP-S	97390			.044
2009-08	V6 3.3L		<b>IFR5G11</b>	<b>7854</b>	FR5AHX	95839	BKR5EIX-11	5464	BKR5EGP	7090	BKR5E-11	6953	.044
	V6 3.8L		<b>IFR5G11</b>	<b>7854</b>	FR5AHX	95839	BKR5EIX-11	5464	BKR5EGP	7090	BKR5E-11	6953	.044
2007	V6 3.8L		<b>IFR5G11</b>	<b>7854</b>	FR5AHX	95839	BKR5EIX-11	5464	BKR5EGP	7090	BKR5E-11	6953	.044
2006-03	V6 3.5L		<b>PFR5N-11</b>	<b>5838</b>	FR5BHX	96457	BKR5EIX-11	5464	BKR5EGP	7090	BKR5E-11	6953	.044
<b>Soul</b>													
2017	L4 1.6L	Naturally Aspirated	<b>SILZKR6B10E</b>	<b>93815</b>	LKR6BHX-E	93763	LZKR6AIX	92873	LZKR6AGP-E	94017			.040
	L4 2.0L		<b>SILZKR7B11</b>	<b>9723</b>	LKR7BHX	94705	LKR7DIX-11S	93175	LKR7BGP-S	97390			.044
2016-12	L4 1.6L		<b>SILZKR6B10E</b>	<b>93815</b>	LKR6BHX-E	93763	LZKR6AIX	92873	LZKR6AGP-E	94017			.040
	L4 2.0L		<b>SILZKR7B11</b>	<b>9723</b>	LKR7BHX	94705	LKR7DIX-11S	93175	LKR7BGP-S	97390			.044
2011-10	L4 1.6L		LKR7E	1643	LKR7BHX	94705	LKR7AIX	93911	LKR7BGP-8	95983			.032
	L4 2.0L		<b>IZFR5L11</b>	<b>97932</b>	FR5BHX	96457	ZFR5FIX-11	2477	ZFR5FGP	7098	ZFR5F-11	2262	.044
<b>Spectra</b>													
2009-08	L4 2.0L		<b>IZFR5L11</b>	<b>97932</b>	FR5BHX	96457	ZFR5FIX-11	2477	ZFR5FGP	7098	ZFR5F-11	2262	.044
2007-05	L4 2.0L		<b>PFR5N-11</b>	<b>5838</b>	FR5BHX	96457	BKR5EIX-11	5464	BKR5EGP	7090	BKR5E-11	6953	.044
2004	L4 1.8L		<b>BKR6E</b>	<b>6962</b>	FR6BHX-S	95159	BKR6EIX	6418	BKR6EGP	7092	BKR6E	6962	.032
	L4 2.0L		<b>PFR5N-11</b>	<b>5838</b>	FR5BHX	96457	BKR5EIX-11	5464	BKR5EGP	7090	BKR5E-11	6953	.044
2003-00	L4 1.8L		<b>BKR6E</b>	<b>6962</b>	FR6BHX-S	95159	BKR6EIX	6418	BKR6EGP	7092	BKR6E	6962	.032
<b>Spectra5</b>													
2009-08	L4 2.0L		<b>IZFR5L11</b>	<b>97932</b>	FR5BHX	96457	ZFR5FIX-11	2477	ZFR5FGP	7098	ZFR5F-11	2262	.044
2007-05	L4 2.0L		<b>PFR5N-11</b>	<b>5838</b>	FR5BHX	96457	BKR5EIX-11	5464	BKR5EGP	7090	BKR5E-11	6953	.044
<b>Sportage</b>													
2017-16	L4 2.4L		<b>SILZKR7E11</b>	<b>92315</b>	LKR7AHX-S	96358	LKR7DIX-11S	93175					.044
2015-14	L4 2.4L		DILKR6C11	93199									.044
2013-11	L4 2.4L		DILFR5A-11D	98376	LF5AHX	96355	LF5AIX-11	4469	LF5AGP	5018			.044
2010-05	L4 2.0L		<b>PFR5N-11</b>	<b>5838</b>	FR5BHX	96457	BKR5EIX-11	5464	BKR5EGP	7090	BKR5E-11	6953	.044
	V6 2.7L		<b>IFR5G11</b>	<b>7854</b>	FR5BHX	96457	BKR5EIX-11	5464	BKR5EGP	7090	BKR5E-11	6953	.044
2002-97	L4 2.0L		<b>BKR6E-11</b>	<b>2756</b>	FR6BHX-S	95159	BKR6EIX-11	3764	BKR6EGP	7092	BKR6E-11	2756	.044
1996	L4 2.0L		<b>BKR6E-11</b>	<b>2756</b>			BKR6EIX-11	3764	BKR6EGP	7092	BKR6E-11	2756	.044
1995	L4 2.0L	DOHC	<b>BKR6E-11</b>	<b>2756</b>			BKR6EIX-11	3764	BKR6EGP	7092	BKR6E-11	2756	.044
		SOHC	<b>BKR5E</b>	<b>7938</b>			BKR5EIX	6341	BKR5EGP	7090	BKR5E	7938	.032
<b>LADA</b>													
<b>Niva</b>													
1993-85	L4 1.6L		<b>BPR6ES</b>	<b>7131</b>			BPR6EIX	6637	BPR6EGP	7084	BPR6EY	6427	.025
<b>Samara</b>													
1993-88	L4 1.3L		<b>BPR6ES</b>	<b>7131</b>			BPR6EIX	6637	BPR6EGP	7084	BPR6EY	6427	.025
	L4 1.5L		<b>BPR6ES</b>	<b>7131</b>			BPR6EIX	6637	BPR6EGP	7084	BPR6EY	6427	.025
<b>Signet</b>													
1993-88	L4 1.5L		<b>BPR6ES</b>	<b>7131</b>			BPR6EIX	6637	BPR6EGP	7084	BPR6EY	6427	.025
1987-85	L4 1.3L		<b>BPR6ES</b>	<b>7131</b>			BPR6EIX	6637	BPR6EGP	7084	BPR6EY	6427	.025
	L4 1.5L		<b>BPR6ES</b>	<b>7131</b>			BPR6EIX	6637	BPR6EGP	7084	BPR6EY	6427	.025
<b>LAMBORGHINI</b>													
<b>Countach</b>													
1989-86	V12 5.2L		DPR9EIX-9	5545			DPR9EIX-9	5545					.036
1985	V12 4.8L		BR8EIX	5044			BR8EIX	5044					.020
	V12 5.2L		DPR9EIX-9	5545			DPR9EIX-9	5545					.036
<b>Diablo</b>													
2000-99	V12 5.7L		DR8EA	7162			DR8EIX	6681					.024
1998	V12 5.7L	VT	DR8EA	7162			DR8EIX	6681					.024
1997	V12 5.7L		DR8EA	7162			DR8EIX	6681					.024
1996-92	V12 5.7L		DR9EA	3437			DR9EIX	4772					.032
1991	V12 5.7L		DPR9EIX-9	5545			DPR9EIX-9	5545					.036
1990	V12 5.7L		DCPR8E	4339			DCPR8EIX	6546					.028
<b>Jalpa</b>													
1988-85	V8 3.5L		BR8EIX	5044			BR8EIX	5044					.020

**Bold denotes NGK OE Manufacturer and/or OE Service Part**  
NOT BOLD denotes OE Equivalent Part

**Le texte en gras désigne une pièce d'équipement originale du manufacturier NGK et/ou pièce d'équipement originale de service**  
Le texte non en gras désigne une pièce d'équipement originale équivalente

Note: Due to different operating or engine conditions, alternate heat range plugs may be required.

Note: En raison de différences au niveau du fonctionnement ou des conditions du moteur, d'autres types de bougies avec variation de chaleur peuvent être nécessaires



Year	Cyl. L	Notes	Original Equipment		Ruthenium HX		Iridium IX		G-Power		V-Power		Gap
			Part	Stock	Part	Stock	Part	Stock	Part	Stock	Part	Stock	
<b>LAMBORGHINI (Cont'd)</b>													
LM002													
1990-86	V12 5.2L		DPR9EIX-9	5545			DPR9EIX-9	5545					.036
<b>LAND ROVER</b>													
Defender 90													
1997	V8 4.0L		BPR5ES	7734			BPR5EIX	6597	BPR5EGP	7082	BPR5EY	1233	.032
1995-94	V8 3.9L		BPR5ES	7734			BPR5EIX	6597	BPR5EGP	7082	BPR5EY	1233	.032
Defender 110													
1993	V8 3.9L		BPR5ES	7734			BPR5EIX	6597	BPR5EGP	7082	BPR5EY	1233	.032
Discovery													
2004-03	V8 4.6L		PFR6N-11	3546	FR6BHX-S	95159	BKR6EIX-11	3764	BKR6EGP	7092	BKR6E-11	2756	.044
2002-00	V8 4.0L		PFR6N-11	3546	FR6BHX-S	95159	BKR6EIX-11	3764	BKR6EGP	7092	BKR6E-11	2756	.044
1999	V8 4.0L	SD	BPR6ES	7131			BPR6EIX	6637	BPR6EGP	7084	BPR6EY	6427	.032
		SE7	BPR6ES	7131			BPR6EIX	6637	BPR6EGP	7084	BPR6EY	6427	.032
		Series II	PFR6N-11	3546	FR6BHX-S	95159	BKR6EIX-11	3764	BKR6EGP	7092	BKR6E-11	2756	.044
1998-96	V8 4.0L		BPR6ES	7131			BPR6EIX	6637	BPR6EGP	7084	BPR6EY	6427	.032
1995-94	V8 3.9L		BPR6ES	7131			BPR6EIX	6637	BPR6EGP	7084	BPR6EY	6427	.032
Discovery Sport													
2016-15	L4 2.0L		<b>ILTR6G8G</b>	<b>96621</b>	LTR6BHX	90495	LTR6IX	94374	LTR6GP-8	94372			.032
Freelander													
2005-02	V6 2.5L		PFR6N-11	3546	FR6AHX-S	94279	BKR6EIX-11	3764	BKR6EGP	7092	BKR6E-11	2756	.044
LR2													
2015-13	L4 2.0L		<b>ILTR6G8G</b>	<b>96621</b>	LTR6BHX	90495	LTR6IX	94374	LTR6GP-8	94372			.032
2012-08	L6 3.2L		<b>ILFR6B</b>	<b>6481</b>	LFR6BHX	93420	LFR6AIX	93893	LFR6CGP	1483			.030
LR3													
2009-05	V6 4.0L		TR55-1	2683			TR55-1IX	7316	TR55-1GP	7159	TR55-1	2683	.054
	V8 4.4L		<b>IFR5N10</b>	<b>7866</b>	FR5AHX	95839	BKR5EIX-11	5464	BKR5EGP	7090	BKR5E	7938	.039
LR4													
2016-14	V6 3.0L		<b>SILZKAR7E8S</b>	<b>93476</b>									.032
2013-10	V8 5.0L		<b>ILKAR7C10</b>	<b>94940</b>									.040
Range Rover													
2017-16	V6 3.0L	GAS	<b>SILZKAR7E8S</b>	<b>93476</b>									.032
	V8 5.0L		<b>ILKAR7C10</b>	<b>94940</b>									.040
2015-14	V6 3.0L		<b>SILZKAR7E8S</b>	<b>93476</b>									.032
	V8 5.0L		<b>ILKAR7C10</b>	<b>94940</b>									.040
2013-10	V8 5.0L		<b>ILKAR7C10</b>	<b>94940</b>									.040
2009-06	V8 4.2L		<b>IFR5N10</b>	<b>7866</b>	FR5BHX	96457	BKR5EIX-11	5464	BKR5EGP	7090	BKR5E	7938	.039
	V8 4.4L		<b>IFR5N10</b>	<b>7866</b>	FR5AHX	95839	BKR5EIX-11	5464	BKR5EGP	7090	BKR5E	7938	.039
2005-03	V8 4.4L		<b>BKR6EQUP</b>	<b>3199</b>	FR6AHX-S	94279	BKR6EIX	6418	BKR6EGP	7092	BKR6E	6962	.032
2002-01	V8 4.6L		BPR5ES	7734			BPR5EIX	6597	BPR5EGP	7082	BPR5EY	1233	.032
2000-96	V8 4.0L		BPR5ES	7734			BPR5EIX	6597	BPR5EGP	7082	BPR5EY	1233	.032
	V8 4.6L		BPR5ES	7734			BPR5EIX	6597	BPR5EGP	7082	BPR5EY	1233	.032
1995	V8 3.9L		BPR5ES	7734			BPR5EIX	6597	BPR5EGP	7082	BPR5EY	1233	.032
	V8 4.0L		BPR5ES	7734			BPR5EIX	6597	BPR5EGP	7082	BPR5EY	1233	.032
	V8 4.2L		BPR5ES	7734			BPR5EIX	6597	BPR5EGP	7082	BPR5EY	1233	.032
1994-93	V8 3.9L		BPR5ES	7734			BPR5EIX	6597	BPR5EGP	7082	BPR5EY	1233	.032
	V8 4.2L		BPR5ES	7734			BPR5EIX	6597	BPR5EGP	7082	BPR5EY	1233	.032
1992-89	V8 3.9L		BPR5ES	7734			BPR5EIX	6597	BPR5EGP	7082	BPR5EY	1233	.032
1988-87	V8 3.5L		BPR5ES	7734			BPR5EIX	6597	BPR5EGP	7082	BPR5EY	1233	.035
Range Rover Evoque													
2016-12	L4 2.0L		<b>ILTR6G8G</b>	<b>96621</b>	LTR6BHX	90495	LTR6IX	94374	LTR6GP-8	94372			.032
Range Rover Sport													
2017-16	V6 3.0L	GAS	<b>SILZKAR7E8S</b>	<b>93476</b>									.032
	V8 5.0L		<b>ILKAR7C10</b>	<b>94940</b>									.040
2015-14	V6 3.0L		<b>SILZKAR7E8S</b>	<b>93476</b>									.032
	V8 5.0L		<b>ILKAR7C10</b>	<b>94940</b>									.040
2013-10	V8 5.0L		<b>ILKAR7C10</b>	<b>94940</b>									.040
2009-06	V8 4.2L		<b>IFR5N10</b>	<b>7866</b>	FR5BHX	96457	BKR5EIX-11	5464	BKR5EGP	7090	BKR5E	7938	.039
	V8 4.4L		<b>IFR5N10</b>	<b>7866</b>	FR5AHX	95839	BKR5EIX-11	5464	BKR5EGP	7090	BKR5E	7938	.039





Year	Cyl. L	Notes	Original Equipment		Ruthenium HX		Iridium IX		G-Power		V-Power		Gap
			Part	Stock	Part	Stock	Part	Stock	Part	Stock	Part	Stock	
<b>LEXUS</b>													
<b>CT200h</b>													
2015	L4 1.8L	To 3/2015	ILKAR7B11	4912	LKAR7AHX-S	92274	LKAR7BIX-11S	93501	LKAR7AGP-D	93220			.044
2014-11	L4 1.8L		ILKAR7B11	4912	LKAR7AHX-S	92274	LKAR7BIX-11S	93501	LKAR7AGP-D	93220			.044
<b>ES250</b>													
1991-90	V6 2.5L		<b>BCPR6EP-11</b>	<b>3350</b>			BCPR6EIX-11	4919	BCPR6EGP	7088	BCPR6E-11	5632	.044
<b>ES300</b>													
2003-02	V6 3.0L		<b>IFR6T11</b>	<b>4589</b>	FR6AHX-S	94279	BKR6EIX-11	3764	BKR6EGP	7092	BKR6E-11	2756	.044
2001-99	V6 3.0L		<b>IFR6T11</b>	<b>4589</b>	FR6BHX-S	95159	BKR6EIX-11	3764	BKR6EGP	7092	BKR6E-11	2756	.044
1998-97	V6 3.0L		<b>BKR6EKP-11</b>	<b>3452</b>	FR6BHX-S	95159	BKR6EIX-11	3764	BKR6EGP	7092	BKR6E-11	2756	.044
1996	V6 3.0L		<b>BKR6EKP-11</b>	<b>3452</b>			BKR6EIX-11	3764	BKR6EGP	7092	BKR6E-11	2756	.044
1995-94	V6 3.0L		<b>BKR6EP-11</b>	<b>2978</b>			BKR6EIX-11	3764	BKR6EGP	7092	BKR6E-11	2756	.044
1993-92	V6 3.0L		<b>BCPR6EP-11</b>	<b>3350</b>			BCPR6EIX-11	4919	BCPR6EGP	7088	BCPR6E-11	5632	.044
<b>ES330</b>													
2006-05	V6 3.3L		IFR6T11	4589	FR6AHX-S	94279	BKR6EIX-11	3764	BKR6EGP	7092	BKR6E-11	2756	.044
2004	V6 3.3L		BKR6EP-11	2978	FR6AHX-S	94279	BKR6EIX-11	3764	BKR6EGP	7092	BKR6E-11	2756	.044
<b>ES350</b>													
2017-07	V6 3.5L		DILFR6D11	6176	LFR6AHX-S	94122	LFR6AIX-11	6619	LFR6CGP	1483			.044
<b>GS200t</b>													
2016	L4 2.0L		<b>DILFR7K9G</b>	<b>91961</b>									.036
<b>GS300</b>													
2006	V6 3.0L		DFH6B-11A	6858	LFR6AHX-S	94122							.044
2005-04	L6 3.0L		<b>BKR6EP-11</b>	<b>2978</b>	FR6BHX-S	95159	BKR6EIX-11	3764	BKR6EGP	7092	BKR6E-11	2756	.044
2003	L6 3.0L		BKR6EP-11	2978	FR6BHX-S	95159	BKR6EIX-11	3764	BKR6EGP	7092	BKR6E-11	2756	.044
2002-01	L6 3.0L		<b>IFR6T11</b>	<b>4589</b>	FR6BHX-S	95159	BKR6EIX-11	3764	BKR6EGP	7092	BKR6E-11	2756	.044
2000-98	L6 3.0L		<b>BKR5EKP-11</b>	<b>4302</b>	FR5BHX	96457	BKR5EIX-11	5464	BKR5EGP	7090	BKR5EYA-11	2526	.044
1997	L6 3.0L		<b>BKR5EP-11</b>	<b>3440</b>	FR5AHX	95839	BKR5EIX-11	5464	BKR5EGP	7090	BKR5EYA-11	2526	.044
1996-94	L6 3.0L		<b>BKR5EP-11</b>	<b>3440</b>			BKR5EIX-11	5464	BKR5EGP	7090	BKR5EYA-11	2526	.044
1993	L6 3.0L		<b>BKR6EP-11</b>	<b>2978</b>			BKR6EIX-11	3764	BKR6EGP	7092	BKR6E-11	2756	.044
<b>GS350</b>													
2015-13	V6 3.5L		DFH6B-11A	6858	LFR6AHX-S	94122							.044
2011-07	V6 3.5L		DFH6B-11A	6858	LFR6AHX-S	94122							.044
<b>GS400</b>													
2000-98	V8 4.0L		<b>IFR6T11</b>	<b>4589</b>	FR6AHX-S	94279	BKR6EIX-11	3764	BKR6EGP	7092	BKR6E-11	2756	.044
<b>GS430</b>													
2007-06	V8 4.3L		IFR6T11	4589	FR6AHX-S	94279	BKR6EIX-11	3764	BKR6EGP	7092	BKR6E-11	2756	.044
2005-01	V8 4.3L		<b>IFR6T11</b>	<b>4589</b>	FR6AHX-S	94279	BKR6EIX-11	3764	BKR6EGP	7092	BKR6E-11	2756	.044
<b>GS450h</b>													
2011-07	V6 3.5L		DFH6B-11A	6858	LFR6AHX-S	94122							.044
<b>GS460</b>													
2011-08	V8 4.6L		DFH6B-11A	6858	LFR6AHX-S	94122							.044
<b>GS Turbo</b>													
2017	L4 2.0L		<b>DILFR7K9G</b>	<b>91961</b>									.036
<b>GX460</b>													
2017-10	V8 4.6L		ILFR6T11	4904	LFR6AHX-S	94122	LFR6AIX-11	6619	LFR6CGP	1483	LFR6C-11	7787	.044
<b>GX470</b>													
2009-05	V8 4.7L		IFR6T11	4589	FR6AHX-S	94279	BKR6EIX-11	3764	BKR6EGP	7092	BKR6E-11	2756	.044
2004-03	V8 4.7L		BKR6EP-11	2978	FR6AHX-S	94279	BKR6EIX-11	3764	BKR6EGP	7092	BKR6E-11	2756	.044
<b>HS250h</b>													
2012-10	L4 2.4L		IFR6T11	4589	FR6AHX-S	94279	BKR6EIX-11	3764	BKR6EGP	7092	BKR6E-11	2756	.044
<b>IS200t</b>													
2016	L4 2.0L		<b>DILFR7K9G</b>	<b>91961</b>									.036
<b>IS250</b>													
2015-06	V6 2.5L		DFH6B-11A	6858	LFR6AHX-S	94122							.044
<b>IS300</b>													
2017-16	V6 3.5L		DFH6B-11A	6858	LFR6AHX-S	94122							.044
2005-04	L6 3.0L		<b>IFR6T11</b>	<b>4589</b>	FR6BHX-S	95159	BKR6EIX-11	3764	BKR6EGP	7092	BKR6E-11	2756	.044
2003	L6 3.0L		BKR6EP-11	2978	FR6BHX-S	95159	BKR6EIX-11	3764	BKR6EGP	7092	BKR6E-11	2756	.044
2002-01	L6 3.0L		<b>IFR6T11</b>	<b>4589</b>	FR6BHX-S	95159	BKR6EIX-11	3764	BKR6EGP	7092	BKR6E-11	2756	.044

**Bold denotes NGK OE Manufacturer and/or OE Service Part**  
NOT BOLD denotes OE Equivalent Part

**Le texte en gras désigne une pièce d'équipement originale du manufacturier NGK et/ou pièce d'équipement originale de service**  
Le texte non en gras désigne une pièce d'équipement originale équivalente

Note: Due to different operating or engine conditions, alternate heat range plugs may be required.

Note: En raison de différences au niveau du fonctionnement ou des conditions du moteur, d'autres types de bougies avec variation de chaleur peuvent être nécessaires



Year	Cyl. L	Notes	Original Equipment		Ruthenium HX		Iridium IX		G-Power		V-Power		Gap
			Part	Stock	Part	Stock	Part	Stock	Part	Stock	Part	Stock	
<b>LEXUS (Cont'd)</b>													
<b>IS350</b>													
2017-06	V6 3.5L		DFH6B-11A	6858	LFR6AHX-S	94122							.044
<b>IS F</b>													
2014-08	V8 5.0L		DFH6B-11A	6858	LFR6AHX-S	94122							.044
<b>IS Turbo</b>													
2017	L4 2.0L		<b>DILFR7K9G</b>	<b>91961</b>									.036
<b>LS400</b>													
2000-98	V8 4.0L		<b>IFR6T11</b>	<b>4589</b>	FR6AHX-S	94279	BKR6EIX-11	3764	BKR6EGP	7092	BKR6E-11	2756	.044
1997	V8 4.0L		<b>BKR6EP-11</b>	<b>2978</b>	FR6AHX-S	94279	BKR6EIX-11	3764	BKR6EGP	7092	BKR6E-11	2756	.044
1996-90	V8 4.0L		<b>BKR6EP-11</b>	<b>2978</b>			BKR6EIX-11	3764	BKR6EGP	7092	BKR6E-11	2756	.044
<b>LS430</b>													
2006	V8 4.3L		BKR6EP-11	2978	FR6AHX-S	94279	BKR6EIX-11	3764	BKR6EGP	7092	BKR6E-11	2756	.044
2005-04	V8 4.3L		<b>IFR6T11</b>	<b>4589</b>	FR6AHX-S	94279	BKR6EIX-11	3764	BKR6EGP	7092	BKR6E-11	2756	.044
2003	V8 4.3L		BKR6EP-11	2978	FR6AHX-S	94279	BKR6EIX-11	3764	BKR6EGP	7092	BKR6E-11	2756	.044
2002-01	V8 4.3L		<b>IFR6T11</b>	<b>4589</b>	FR6AHX-S	94279	BKR6EIX-11	3764	BKR6EGP	7092	BKR6E-11	2756	.044
<b>LS460</b>													
2017-07	V8 4.6L		DFH6B-11A	6858	LFR6AHX-S	94122							.044
<b>LS600h</b>													
2016-08	V8 5.0L		DFH6B-11A	6858	LFR6AHX-S	94122							.044
<b>LX450</b>													
1997	L6 4.5L		<b>BKR5EYA</b>	<b>2087</b>	FR5AHX	95839	BKR5EIX	6341	BKR5EGP	7090	BKR5EYA	2087	.032
1996	L6 4.5L		<b>BKR5EYA</b>	<b>2087</b>			BKR5EIX	6341	BKR5EGP	7090	BKR5EYA	2087	.032
<b>LX470</b>													
2007-05	V8 4.7L		IFR6T11	4589	FR6AHX-S	94279	BKR6EIX-11	3764	BKR6EGP	7092	BKR6E-11	2756	.044
2004-03	V8 4.7L		BKR6EP-11	2978	FR6AHX-S	94279	BKR6EIX-11	3764	BKR6EGP	7092	BKR6E-11	2756	.044
2002-98	V8 4.7L		<b>IFR6T11</b>	<b>4589</b>	FR6AHX-S	94279	BKR6EIX-11	3764	BKR6EGP	7092	BKR6E-11	2756	.044
<b>LX570</b>													
2017-13	V8 5.7L		ILFR6T11	4904	LFR6AHX-S	94122	LFR6AIX-11	6619	LFR6CGP	1483	LFR6C-11	7787	.044
2011-08	V8 5.7L		ILFR6T11	4904	LFR6AHX-S	94122	LFR6AIX-11	6619	LFR6CGP	1483	LFR6C-11	7787	.044
<b>NX200t</b>													
2017-15	L4 2.0L		<b>DILFR7K9G</b>	<b>91961</b>									.036
<b>RC200t</b>													
2016	L4 2.0L		<b>DILFR7K9G</b>	<b>91961</b>									.036
<b>RC300</b>													
2017-16	V6 3.5L		DFH6B-11A	6858	LFR6AHX-S	94122							.044
<b>RC350</b>													
2017-15	V6 3.5L		DFH6B-11A	6858	LFR6AHX-S	94122							.044
<b>RC Turbo</b>													
2017	L4 2.0L		<b>DILFR7K9G</b>	<b>91961</b>									.036
<b>RX300</b>													
2003-99	V6 3.0L		<b>IFR6T11</b>	<b>4589</b>	FR6AHX-S	94279	BKR6EIX-11	3764	BKR6EGP	7092	BKR6E-11	2756	.044
<b>RX330</b>													
2006-05	V6 3.3L		IFR6T11	4589	FR6AHX-S	94279	BKR6EIX-11	3764	BKR6EGP	7092	BKR6E-11	2756	.044
2004	V6 3.3L		BKR6EP-11	2978	FR6AHX-S	94279	BKR6EIX-11	3764	BKR6EGP	7092	BKR6E-11	2756	.044
<b>RX350</b>													
2015-07	V6 3.5L		DILFR6D11	6176	LFR6AHX-S	94122	LFR6AIX-11	6619	LFR6CGP	1483			.044
<b>RX400h</b>													
2008-06	V6 3.3L		IFR6T11	4589	FR6AHX-S	94279	BKR6EIX-11	3764	BKR6EGP	7092	BKR6E-11	2756	.044
<b>RX450h</b>													
2015-10	V6 3.5L		DILFR6D11	6176	LFR6AHX-S	94122	LFR6AIX-11	6619	LFR6CGP	1483			.044
<b>SC300</b>													
2000-99	L6 3.0L		<b>BKR5EKP-11</b>	<b>4302</b>	FR5BHX	96457	BKR5EIX-11	5464	BKR5EGP	7090	BKR5EYA-11	2526	.044
1998	L6 3.0L		<b>BKR5EP-11</b>	<b>3440</b>	FR5BHX	96457	BKR5EIX-11	5464	BKR5EGP	7090	BKR5EYA-11	2526	.044
1997	L6 3.0L		<b>BKR5EP-11</b>	<b>3440</b>	FR5AHX	95839	BKR5EIX-11	5464	BKR5EGP	7090	BKR5EYA-11	2526	.044
1996-95	L6 3.0L		<b>BKR5EP-11</b>	<b>3440</b>			BKR5EIX-11	5464	BKR5EGP	7090	BKR5EYA-11	2526	.044
1994	L6 3.0L	From 1/94	<b>BKR5EP-11</b>	<b>3440</b>			BKR5EIX-11	5464	BKR5EGP	7090	BKR5EYA-11	2526	.044
		To 1/94	<b>BKR6EP-11</b>	<b>2978</b>			BKR6EIX-11	3764	BKR6EGP	7092	BKR6E-11	2756	.044
1993	L6 3.0L		<b>BKR6EP-11</b>	<b>2978</b>			BKR6EIX-11	3764	BKR6EGP	7092	BKR6E-11	2756	.044



Year	Cyl. L	Notes	Original Equipment		Ruthenium HX		Iridium IX		G-Power		V-Power		Gap
			Part	Stock	Part	Stock	Part	Stock	Part	Stock	Part	Stock	
<b>LEXUS (Cont'd)</b>													
<b>SC300 (Cont'd)</b>													
1992	L6 3.0L		<b>BKR5EP-11</b>	<b>3440</b>			BKR5EIX-11	5464	BKR5EGP	7090	BKR5EYA-11	2526	.044
<b>SC400</b>													
2000-98	V8 4.0L		<b>IFR6T11</b>	<b>4589</b>	FR6AHX-S	94279	BKR6EIX-11	3764	BKR6EGP	7092	BKR6E-11	2756	.044
1997	V8 4.0L		<b>BKR6EP-11</b>	<b>2978</b>	FR6AHX-S	94279	BKR6EIX-11	3764	BKR6EGP	7092	BKR6E-11	2756	.044
1996-92	V8 4.0L		<b>BKR6EP-11</b>	<b>2978</b>			BKR6EIX-11	3764	BKR6EGP	7092	BKR6E-11	2756	.044
<b>SC430</b>													
2010-02	V8 4.3L		IFR6T11	4589	FR6AHX-S	94279	BKR6EIX-11	3764	BKR6EGP	7092	BKR6E-11	2756	.044
<b>LINCOLN</b>													
<b>Aviator</b>													
2005-03	V8 4.6L		PTR5C-13	7740	TR5AHX	94567	TR55IX	7164	TR55GP	3403	TR55	3951	.054
<b>Blackwood</b>													
2002	V8 5.4L		PTR5C-13	7740	TR5AHX	94567	TR55IX	7164	TR55GP	3403	TR55	3951	.054
<b>Continental</b>													
2017	V6 2.7L		<b>ILTR7N8</b>	<b>95822</b>	LTR7BHX	95605							.032
	V6 3.0L		<b>ILTR7N8</b>	<b>95822</b>	LTR7BHX	95605							.032
	V6 3.7L		<b>LTR6BP13</b>	<b>94806</b>	LTR6AHX	91276	LTR6IX-11	6509					.052
2002-98	V8 4.6L		PTR5C-13	7740	TR5AHX	94567	TR55IX	7164	TR55GP	3403	TR55	3951	.054
1997-95	V8 4.6L		PTR5C-13	7740			TR55IX	7164	TR55GP	3403	TR55	3951	.054
1994-88	V6 3.8L		TR55-1	2683			TR55-1IX	7316	TR55-1GP	7159	TR55-1	2683	.054
1987-86	V8 5.0L		TR55-1	2683			TR55-1IX	7316	TR55-1GP	7159	TR55-1	2683	.050
1985	V8 5.0L		UR45	6945			UR45IX	7559	UR45GP	3207	UR45	6945	.050
<b>LS</b>													
2006	V8 3.9L		<b>FR5AP-11E</b>	<b>6569</b>	FR5AHX-E	92375	BKR5EIX-11	5464	BKR5EGP	7090	BKR5E-11	6953	.044
2005-03	V6 3.0L		PTR5C-13	7740	TR5AHX	94567	TR55IX	7164	TR55GP	3403	TR55	3951	.054
	V8 3.9L		<b>FR5AP-11E</b>	<b>6569</b>	FR5AHX-E	92375	BKR5EIX-11	5464	BKR5EGP	7090	BKR5E-11	6953	.044
2002-00	V6 3.0L		PTR5C-13	7740	TR5AHX	94567	TR55IX	7164	TR55GP	3403	TR55	3951	.054
	V8 3.9L		PFR5G-11	2647	FR5AHX	95839	BKR5EIX-11	5464	BKR5EGP	7090	BKR5E-11	6953	.044
<b>Mark LT</b>													
2008	V8 5.4L	New Eng. Design w/Brown Coil Boots ONLY. NO NGK Part # for Old Eng. Design (w/Black Coil Boots)	<b>PZNR6A11H</b>	<b>5507</b>			ZNR6AIX-11	372	ZNR6AGP	1698			.044
<b>Mark VII</b>													
1992-88	V8 5.0L		UR45	6945			UR45IX	7559	UR45GP	3207	UR45	6945	.054
1987	V8 5.0L	Vin F	TR55-1	2683			TR55-1IX	7316	TR55-1GP	7159	TR55-1	2683	.050
		Vin M	UR45	6945			UR45IX	7559	UR45GP	3207	UR45	6945	.054
1986	V8 5.0L		TR55-1	2683			TR55-1IX	7316	TR55-1GP	7159	TR55-1	2683	.050
1985	V8 5.0L	Vin F	UR45	6945			UR45IX	7559	UR45GP	3207	UR45	6945	.050
		Vin M	TR55-1	2683			TR55-1IX	7316	TR55-1GP	7159	TR55-1	2683	.050
<b>Mark VIII</b>													
1998-97	V8 4.6L		PTR5C-13	7740	TR5AHX	94567	TR55IX	7164	TR55GP	3403	TR55	3951	.054
1996-95	V8 4.6L		PTR5C-13	7740			TR55IX	7164	TR55GP	3403	TR55	3951	.054
1994-93	V8 4.6L		TR55	3951			TR55IX	7164	TR55GP	3403	TR55	3951	.054
<b>MKC</b>													
2017-15	L4 2.0L		<b>LTR6DI-8</b>	<b>96588</b>	LTR6BHX	90495	LTR6IX	94374	LTR6GP-8	94372			.032
	L4 2.3L		<b>LTR6DI-8</b>	<b>96588</b>	LTR6BHX	90495	LTR6IX	94374	LTR6GP-8	94372			.032
<b>MKS</b>													
2016-14	V6 3.5L		<b>LTR6CI-8</b>	<b>97177</b>	LTR6BHX	90495	LTR6IX	94374	LTR6GP-8	94372			.032
	V6 3.7L		<b>LTR6BP13</b>	<b>94806</b>	LTR6AHX	91276	LTR6IX-11	6509					.052
2013	V6 3.5L		<b>LTR6CI-8</b>	<b>97177</b>	LTR6BHX	90495	LTR6IX	94374	LTR6GP-8	94372			.032
	V6 3.7L		<b>PTR5A-13</b>	<b>2467</b>	LTR5AHX	90220	LTR5IX-11	4344	LTR5GP	5019			.052
2012-10	V6 3.5L		<b>LTR6CI-8</b>	<b>97177</b>	LTR6BHX	90495	LTR6IX	94374	LTR6GP-8	94372			.032
	V6 3.7L		<b>ILTR5K13</b>	<b>90607</b>	LTR5AHX	90220	LTR5IX-11	4344	LTR5GP	5019			.052
2009	V6 3.7L		<b>ILTR5K13</b>	<b>90607</b>	LTR5AHX	90220	LTR5IX-11	4344	LTR5GP	5019			.052
<b>MKT</b>													
2019	V6 3.5L		<b>LTR6CI-8</b>	<b>97177</b>	LTR6BHX	90495	LTR6IX	94374	LTR6GP-8	94372			.032
2018-17	V6 3.5L		<b>LTR6CI-8</b>	<b>97177</b>	LTR6BHX	90495	LTR6IX	94374	LTR6GP-8	94372			.032

**Bold denotes NGK OE Manufacturer and/or OE Service Part**  
 NOT BOLD denotes OE Equivalent Part

Note: Due to different operating or engine conditions, alternate heat range plugs may be required.

**Le texte en gras désigne une pièce d'équipement originale du manufacturier NGK et/ou pièce d'équipement originale de service**  
 Le texte non en gras désigne une pièce d'équipement originale équivalente

Note: En raison de différences au niveau du fonctionnement ou des conditions du moteur, d'autres types de bougies avec variation de chaleur peuvent être nécessaires



Year	Cyl. L	Notes	Original Equipment		Ruthenium HX		Iridium IX		G-Power		V-Power		Gap
			Part	Stock	Part	Stock	Part	Stock	Part	Stock	Part	Stock	
<b>LINCOLN (Cont'd)</b>													
<b>MKT (Cont'd)</b>													
2018-17	V6 3.7L		<b>LTR6BP13</b>	<b>94806</b>	LTR6AHX	91276	LTR6IX-11	6509					.052
2016-13	L4 2.0L		<b>LTR6DI-8</b>	<b>96588</b>	LTR6BHX	90495	LTR6IX	94374	LTR6GP-8	94372			.032
	V6 3.5L		<b>LTR6CI-8</b>	<b>97177</b>	LTR6BHX	90495	LTR6IX	94374	LTR6GP-8	94372			.032
	V6 3.7L		<b>LTR6BP13</b>	<b>94806</b>	LTR6AHX	91276	LTR6IX-11	6509					.052
2012	V6 3.5L		<b>LTR6CI-8</b>	<b>97177</b>	LTR6BHX	90495	LTR6IX	94374	LTR6GP-8	94372			.032
	V6 3.7L	From 2/27/2012	<b>LTR6BP13</b>	<b>94806</b>	LTR6AHX	91276	LTR6IX-11	6509					.052
		To 2/27/2012	<b>ILTR5K13</b>	<b>90607</b>	LTR5AHX	90220	LTR5IX-11	4344	LTR5GP	5019			.052
2011-10	V6 3.5L		<b>LTR6CI-8</b>	<b>97177</b>	LTR6BHX	90495	LTR6IX	94374	LTR6GP-8	94372			.032
	V6 3.7L		<b>ILTR5K13</b>	<b>90607</b>	LTR5AHX	90220	LTR5IX-11	4344	LTR5GP	5019			.052
<b>MKX</b>													
2017-16	V6 2.7L		<b>ILTR7N8</b>	<b>95822</b>	LTR7BHX	95605							.032
	V6 3.7L		<b>LTR6BP13</b>	<b>94806</b>	LTR6AHX	91276	LTR6IX-11	6509					.052
2015-11	V6 3.7L		<b>LTR6BP13</b>	<b>94806</b>	LTR6AHX	91276	LTR6IX-11	6509					.052
2010-07	V6 3.5L		<b>ILTR5K13</b>	<b>90607</b>	LTR5AHX	90220	LTR5IX-11	4344	LTR5GP	5019			.052
<b>MKZ</b>													
2018	V6 3.0L		<b>ILTR7N8</b>	<b>95822</b>	LTR7BHX	95605							.032
2017	L4 2.0L	Naturally Aspirated	<b>ILTR5K13</b>	<b>90607</b>	LTR5AHX	90220	LTR5IX-11	4344	LTR5GP	5019			.052
		Turbo	<b>LTR6DI-8</b>	<b>96588</b>	LTR6BHX	90495	LTR6IX	94374	LTR6GP-8	94372			.032
	V6 3.0L		<b>ILTR7N8</b>	<b>95822</b>	LTR7BHX	95605							.032
2016-13	L4 2.0L	Naturally Aspirated	<b>ILTR5K13</b>	<b>90607</b>	LTR5AHX	90220	LTR5IX-11	4344	LTR5GP	5019			.052
		Turbo	<b>LTR6DI-8</b>	<b>96588</b>	LTR6BHX	90495	LTR6IX	94374	LTR6GP-8	94372			.032
	V6 3.7L		<b>LTR6BP13</b>	<b>94806</b>	LTR6AHX	91276	LTR6IX-11	6509					.052
2012-11	L4 2.5L		<b>ILTR5K13</b>	<b>90607</b>	LTR5AHX	90220	LTR5IX-11	4344	LTR5GP	5019			.052
	V6 3.5L		<b>ILTR5K13</b>	<b>90607</b>	LTR5AHX	90220	LTR5IX-11	4344	LTR5GP	5019			.052
2010-07	V6 3.5L		<b>ILTR5K13</b>	<b>90607</b>	LTR5AHX	90220	LTR5IX-11	4344	LTR5GP	5019			.052
<b>Navigator</b>													
2017-15	V6 3.5L		<b>LTR6CI-8</b>	<b>97177</b>	LTR6BHX	90495	LTR6IX	94374	LTR6GP-8	94372			.032
2014-09	V8 5.4L		<b>PZNAR6A11H</b>	<b>5507</b>			ZNAR6AIX-11	372	ZNAR6AGP	1698			.044
2008	V8 5.4L	New Eng. Design w/Brown Coil Boots ONLY. NO NGK Part # for Old Eng. Design (w/Black Coil Boots)	<b>PZNAR6A11H</b>	<b>5507</b>			ZNAR6AIX-11	372	ZNAR6AGP	1698			.044
2004-98	V8 5.4L		PTR5C-13	7740	TR5AHX	94567	TR55IX	7164	TR55GP	3403	TR55	3951	.054
<b>Town Car</b>													
2011-09	V8 4.6L	FLEX, FFV and/or CNG Fuel Conversions	PTR6D-13	5598	TR6AHX	92714	TR6IX	3689	TR6GP	5141	TR6	4177	.044
		GAS	TR55	3951	TR5AHX	94567	TR55IX	7164	TR55GP	3403	TR55	3951	.054
2008-06	V8 4.6L	FLEX, FFV and/or CNG Fuel Conversions	PTR6D-13	5598	TR6AHX	92714	TR6IX	3689	TR6GP	5141	TR6	4177	.044
		GAS	PTR5C-13	7740	TR5AHX	94567	TR55IX	7164	TR55GP	3403	TR55	3951	.054
2005-98	V8 4.6L	GAS	PTR5C-13	7740	TR5AHX	94567	TR55IX	7164	TR55GP	3403	TR55	3951	.054
1997-96	V8 4.6L	GAS	PTR5C-13	7740			TR55IX	7164	TR55GP	3403	TR55	3951	.054
1995	V8 4.6L		PTR5C-13	7740			TR55IX	7164	TR55GP	3403	TR55	3951	.054
1994-91	V8 4.6L		TR55	3951			TR55IX	7164	TR55GP	3403	TR55	3951	.054
1990-86	V8 5.0L		TR55-1	2683			TR55-1IX	7316	TR55-1GP	7159	TR55-1	2683	.050
1985	V8 5.0L		UR45	6945			UR45IX	7559	UR45GP	3207	UR45	6945	.050
<b>Zephyr</b>													
2006	V6 3.0L		PTR5C-13	7740	TR5AHX	94567	TR55IX	7164	TR55GP	3403	TR55	3951	.054
<b>LOTUS</b>													
<b>Elan</b>													
1992	L4 1.6L		BKR6E	6962			BKR6EIX	6418	BKR6EGP	7092	BKR6E	6962	.035
1991	L4 1.6L		BKR6E-11	2756			BKR6EIX-11	3764	BKR6EGP	7092	BKR6E-11	2756	.044
1990	L4 1.6L		BKR6E	6962			BKR6EIX	6418	BKR6EGP	7092	BKR6E	6962	.035
<b>Elise</b>													
2007	L4 1.8L		PFR6N-11	3546	FR6AHX-S	94279	BKR6EIX-11	3764	BKR6EGP	7092	BKR6E-11	2756	.044
2006	L4 1.8L		<b>PFR6N-11</b>	<b>3546</b>	FR6AHX-S	94279	BKR6EIX-11	3764	BKR6EGP	7092	BKR6E-11	2756	.044
2005	L4 1.8L		PFR6N-11	3546	FR6AHX-S	94279	BKR6EIX-11	3764	BKR6EGP	7092	BKR6E-11	2756	.044



Year	Cyl. L	Notes	Original Equipment		Ruthenium HX		Iridium IX		G-Power		V-Power		Gap
			Part	Stock	Part	Stock	Part	Stock	Part	Stock	Part	Stock	
<b>LOTUS (Cont'd)</b>													
Esprit													
2003-97	V8 3.5L		<b>BKR6EKC</b>	<b>4959</b>	FR6BHX-S	95159	BKR6EIX	6418	BKR6EGP	7092	BKR6E	6962	.035
1995-92	L4 2.2L		BPR6EKN	6757			BPR6EIX	6637	BPR6EGP	7084			.032
1991-90	L4 2.2L	CAN	BPR6EKN	6757			BPR6EIX	6637	BPR6EGP	7084			.032
		USA	BPR7ES	5534			BPR7EIX	4055					.025
1989	L4 2.2L	CAN	BPR6ES	7131			BPR6EIX	6637	BPR6EGP	7084	BPR6EY	6427	.035
		USA	BPR7ES	5534			BPR7EIX	4055					.025
1988-87	L4 2.2L	Naturally Aspirated	BPR6ES	7131			BPR6EIX	6637	BPR6EGP	7084	BPR6EY	6427	.025
		Turbo	BPR6ES	7131			BPR6EIX	6637	BPR6EGP	7084	BPR6EY	6427	.035
1986-85	L4 2.2L		BPR6ES	7131			BPR6EIX	6637	BPR6EGP	7084	BPR6EY	6427	.035
Exige													
2006	L4 1.8L		<b>PFR6N-11</b>	<b>3546</b>	FR6AHX-S	94279	BKR6EIX-11	3764	BKR6EGP	7092	BKR6E-11	2756	.044
<b>MASERATI</b>													
228i													
1990-89	V6 2.8L		BPR7ES	5534			BPR7EIX	4055					.028
425													
1987-86	V6 2.5L		BPR7ES	5534			BPR7EIX	4055					.028
430i													
1990-89	V6 2.8L		BPR8ES	3923			BPR8EIX	6684					.028
Biturbo													
1987	V6 2.5L	CARB	BPR8ES	3923			BPR8EIX	6684					.028
		FI	BPR7ES	5534			BPR7EIX	4055					.028
1986-85	V6 2.5L		BPR8ES	3923			BPR8EIX	6684					.028
Coupe													
2006-05	V8 4.2L		<b>PMR8B</b>	<b>6378</b>									.028
2004-03	V8 4.2L		PMR8A	5851									.032
GranSport													
2006-05	V8 4.2L		<b>PMR8B</b>	<b>6378</b>									.028
GranTurismo													
2011-09	V8 4.2L		<b>PMR8C-H</b>	<b>96361</b>									.028
	V8 4.7L		<b>PMR8C-H</b>	<b>96361</b>									.028
2008	V8 4.2L		<b>PMR8C-H</b>	<b>96361</b>									.028
Quattroporte													
2011-09	V8 4.2L		<b>PMR8C-H</b>	<b>96361</b>									.028
	V8 4.7L		<b>PMR8C-H</b>	<b>96361</b>									.028
2008	V8 4.2L		<b>PMR8C-H</b>	<b>96361</b>									.028
2007	V8 4.2L	Automatic	<b>PMR8C-H</b>	<b>96361</b>									.028
		Manual	<b>PMR8B</b>	<b>6378</b>									.028
2006-04	V8 4.2L		<b>PMR8B</b>	<b>6378</b>									.028
1986-85	V8 4.9L		BPR6ES	7131			BPR6EIX	6637	BPR6EGP	7084	BPR6EY	6427	.028
Spyder													
2006-05	V8 4.2L		<b>PMR8B</b>	<b>6378</b>									.028
2004-02	V8 4.2L		PMR8A	5851									.032
1991-89	V6 2.8L		BPR7ES	5534			BPR7EIX	4055					.028
1987-86	V6 2.5L		BPR7ES	5534			BPR7EIX	4055					.028
<b>MAYBACH</b>													
57													
2012-06	V12 5.5L	Dual Plug; 24 Req'd	<b>IFR6Q-G</b>	<b>5648</b>	FR6BHX-S	95159	BKR6EIX	6418	BKR6EGP	7092			.028
	V12 6.0L	Dual Plug; 24 Req'd	<b>IFR6Q-G</b>	<b>5648</b>	FR6BHX-S	95159	BKR6EIX	6418	BKR6EGP	7092			.028
2005-03	V12 5.5L	Dual Plug; 24 Req'd	<b>IFR6Q-G</b>	<b>5648</b>	FR6BHX-S	95159	BKR6EIX	6418	BKR6EGP	7092			.028
62													
2012-07	V12 5.5L	Dual Plug; 24 Req'd	<b>IFR6Q-G</b>	<b>5648</b>	FR6BHX-S	95159	BKR6EIX	6418	BKR6EGP	7092			.028
	V12 6.0L	Dual Plug; 24 Req'd	<b>IFR6Q-G</b>	<b>5648</b>	FR6BHX-S	95159	BKR6EIX	6418	BKR6EGP	7092			.028
2006-03	V12 5.5L	Dual Plug; 24 Req'd	<b>IFR6Q-G</b>	<b>5648</b>	FR6BHX-S	95159	BKR6EIX	6418	BKR6EGP	7092			.028
<b>MAZDA</b>													
2													
2014-11	L4 1.5L		IFR5E11	7994	FR5AHX	95839	BKR5EIX-11	5464	BKR5EGP	7090	BKR5E-11	6953	.048

**Bold denotes NGK OE Manufacturer and/or OE Service Part**  
NOT BOLD denotes OE Equivalent Part

**Le texte en gras désigne une pièce d'équipement originale du manufacturier NGK et/ou pièce d'équipement originale de service**  
Le texte non en gras désigne une pièce d'équipement originale équivalente

Note: Due to different operating or engine conditions, alternate heat range plugs may be required.

Note: En raison de différences au niveau du fonctionnement ou des conditions du moteur, d'autres types de bougies avec variation de chaleur peuvent être nécessaires





Year	Cyl. L	Notes	Original Equipment		Ruthenium HX		Iridium IX		G-Power		V-Power		Gap
			Part	Stock	Part	Stock	Part	Stock	Part	Stock	Part	Stock	
<b>MAZDA (Cont'd)</b>													
<b>3</b>													
2018-14	L4 2.0L		<b>ILKAR7L11</b>	<b>94124</b>	LKAR7AHX-S	92274	LKAR7BIX-11S	93501	LKAR7AGP-D	93220			.044
	L4 2.5L		<b>ILKAR7L11</b>	<b>94124</b>	LKAR7AHX-S	92274	LKAR7BIX-11S	93501	LKAR7AGP-D	93220			.044
2013-12	L4 2.0L	Non-SkyActiv Eng.	<b>LTR5BI-13</b>	<b>90083</b>	LTR5AHX	90220	LTR5IX-11	4344	LTR5GP	5019			.052
		SkyActiv Eng.	<b>ILKAR7L11</b>	<b>94124</b>	LKAR7AHX-S	92274	LKAR7BIX-11S	93501	LKAR7AGP-D	93220			.044
	L4 2.3L		<b>SILTR6A7G</b>	<b>95369</b>	LTR6BHX	90495							.027
	L4 2.5L		<b>LTR5BI-13</b>	<b>90083</b>	LTR5AHX	90220	LTR5IX-11	4344	LTR5GP	5019			.052
2011	L4 2.0L	Non-SkyActiv Eng.	<b>LTR5BI-13</b>	<b>90083</b>	LTR5AHX	90220	LTR5IX-11	4344	LTR5GP	5019			.052
	L4 2.3L		<b>SILTR6A7G</b>	<b>95369</b>	LTR6BHX	90495							.027
	L4 2.5L		<b>LTR5BI-13</b>	<b>90083</b>	LTR5AHX	90220	LTR5IX-11	4344	LTR5GP	5019			.052
2010	L4 2.0L		<b>LTR5BI-13</b>	<b>90083</b>	LTR5AHX	90220	LTR5IX-11	4344	LTR5GP	5019			.052
	L4 2.3L		<b>SILTR6A7G</b>	<b>95369</b>	LTR6BHX	90495							.027
	L4 2.5L		<b>LTR5BI-13</b>	<b>90083</b>	LTR5AHX	90220	LTR5IX-11	4344	LTR5GP	5019			.052
2009-07	L4 2.0L		<b>LTR5BI-13</b>	<b>90083</b>	LTR5AHX	90220	LTR5IX-11	4344	LTR5GP	5019			.052
	L4 2.3L	Naturally Aspirated	<b>LTR5BI-13</b>	<b>90083</b>	LTR5AHX	90220	LTR5IX-11	4344	LTR5GP	5019			.052
		Turbo	<b>ILTR6A-8G</b>	<b>3787</b>	LTR6BHX	90495	LTR6IX	94374	LTR6GP-8	94372			.032
2006	L4 2.0L		<b>LTR5BI-13</b>	<b>90083</b>	LTR5AHX	90220	LTR5IX-11	4344	LTR5GP	5019			.052
	L4 2.3L		<b>LTR5BI-13</b>	<b>90083</b>	LTR5AHX	90220	LTR5IX-11	4344	LTR5GP	5019			.052
2005-04	L4 2.0L		<b>ITR6F13</b>	<b>4477</b>	TR6AHX	92714	TR65IX	3692	TR6GP	5141	TR6	4177	.052
	L4 2.3L		<b>ITR6F13</b>	<b>4477</b>	TR6AHX	92714	TR65IX	3692	TR6GP	5141	TR6	4177	.052
<b>3 Sport</b>													
2018-14	L4 2.0L		<b>ILKAR7L11</b>	<b>94124</b>	LKAR7AHX-S	92274	LKAR7BIX-11S	93501	LKAR7AGP-D	93220			.044
	L4 2.5L		<b>ILKAR7L11</b>	<b>94124</b>	LKAR7AHX-S	92274	LKAR7BIX-11S	93501	LKAR7AGP-D	93220			.044
2013-11	L4 2.0L	Non-SkyActiv Eng.	<b>LTR5BI-13</b>	<b>90083</b>	LTR5AHX	90220	LTR5IX-11	4344	LTR5GP	5019			.052
		SkyActiv Eng.	<b>ILKAR7L11</b>	<b>94124</b>	LKAR7AHX-S	92274	LKAR7BIX-11S	93501	LKAR7AGP-D	93220			.044
	L4 2.5L		<b>LTR5BI-13</b>	<b>90083</b>	LTR5AHX	90220	LTR5IX-11	4344	LTR5GP	5019			.052
2010	L4 2.0L		<b>LTR5BI-13</b>	<b>90083</b>	LTR5AHX	90220	LTR5IX-11	4344	LTR5GP	5019			.052
	L4 2.5L		<b>LTR5BI-13</b>	<b>90083</b>	LTR5AHX	90220	LTR5IX-11	4344	LTR5GP	5019			.052
2009	L4 2.0L		<b>LTR5BI-13</b>	<b>90083</b>	LTR5AHX	90220	LTR5IX-11	4344	LTR5GP	5019			.052
<b>5</b>													
2015-12	L4 2.5L		<b>LTR5BI-13</b>	<b>90083</b>	LTR5AHX	90220	LTR5IX-11	4344	LTR5GP	5019			.052
2010-08	L4 2.3L		<b>LTR5BI-13</b>	<b>90083</b>	LTR5AHX	90220	LTR5IX-11	4344	LTR5GP	5019			.052
2007-06	L4 2.3L		<b>TR5AI-13</b>	<b>90813</b>	TR5AHX	94567	TR55IX	7164	TR55GP	3403	TR55	3951	.052
<b>6</b>													
2017-14	L4 2.5L		<b>ILKAR7L11</b>	<b>94124</b>	LKAR7AHX-S	92274	LKAR7BIX-11S	93501	LKAR7AGP-D	93220			.044
2013-09	L4 2.5L		<b>LTR5BI-13</b>	<b>90083</b>	LTR5AHX	90220	LTR5IX-11	4344	LTR5GP	5019			.052
	V6 3.7L		PLTR6A-10G	3587	LTR6AHX	91276	LTR6IX-11	6509	LTR6GP	90198			.044
2008	L4 2.3L		<b>LTR5BI-13</b>	<b>90083</b>	LTR5AHX	90220	LTR5IX-11	4344	LTR5GP	5019			.052
	V6 3.0L		PTR5F-11	6579	TR5AHX	94567	TR5IX	7397	TR5GP	3186	TR5	2238	.044
2007-06	L4 2.3L	Naturally Aspirated	<b>LTR5BI-13</b>	<b>90083</b>	LTR5AHX	90220	LTR5IX-11	4344	LTR5GP	5019			.052
		Turbo	<b>ILTR6A-8G</b>	<b>3787</b>	LTR6BHX	90495	LTR6IX	94374	LTR6GP-8	94372			.032
	V6 3.0L		PTR5F-11	6579	TR5AHX	94567	TR5IX	7397	TR5GP	3186	TR5	2238	.044
2005-03	L4 2.3L		<b>TR5AI-13</b>	<b>90813</b>			TR55IX	7164	TR55GP	3403	TR55	3951	.052
	V6 3.0L		PTR5F-11	6579	TR5AHX	94567	TR5IX	7397	TR5GP	3186	TR5	2238	.044
<b>323</b>													
1995	L4 1.6L		<b>BPR5EY-11</b>	<b>6937</b>			BPR5EIX-11	2115	BPR5EGP	7082	BPR5EY-11	6937	.044
1994-93	L4 1.6L		<b>BPR5ES-11</b>	<b>7634</b>			BPR5EIX-11	2115	BPR5EGP	7082	BPR5EY-11	6937	.044
	L4 1.8L		<b>BKR5E-11</b>	<b>6953</b>			BKR5EIX-11	5464	BKR5EGP	7090	BKR5E-11	6953	.044
1992	L4 1.6L		<b>BPR5ES-11</b>	<b>7634</b>			BPR5EIX-11	2115	BPR5EGP	7082	BPR5EY-11	6937	.044
1991-90	L4 1.6L		<b>BPR5ES-11</b>	<b>7634</b>			BPR5EIX-11	2115	BPR5EGP	7082	BPR5EY-11	6937	.044
	L4 1.8L		<b>BKR5E-11</b>	<b>6953</b>			BKR5EIX-11	5464	BKR5EGP	7090	BKR5E-11	6953	.044
1989-88	L4 1.6L	Naturally Aspirated	<b>BPR5ES-11</b>	<b>7634</b>			BPR5EIX-11	2115	BPR5EGP	7082	BPR5EY-11	6937	.044
		Turbo	<b>BCPR6E-11</b>	<b>5632</b>			BCPR6EIX-11	4919	BCPR6EGP	7088	BCPR6E-11	5632	.044
1987-86	L4 1.6L		<b>BPR5ES-11</b>	<b>7634</b>			BPR5EIX-11	2115	BPR5EGP	7082	BPR5EY-11	6937	.044
<b>626</b>													
2002-98	L4 2.0L		<b>BKR5E-11</b>	<b>6953</b>	FR5BHX	96457	BKR5EIX-11	5464	BKR5EGP	7090	BKR5E-11	6953	.044
	V6 2.5L		PZFR5F	3741	FR5BHX	96457	ZFR5FIX-11	2477	ZFR5FGP	7098	ZFR5F	7558	.032
1997	L4 2.0L		<b>BKR5E-11</b>	<b>6953</b>	FR5AHX	95839	BKR5EIX-11	5464	BKR5EGP	7090	BKR5E-11	6953	.044



Year	Cyl. L	Notes	Original Equipment		Ruthenium HX		Iridium IX		G-Power		V-Power		Gap
			Part	Stock	Part	Stock	Part	Stock	Part	Stock	Part	Stock	
<b>MAZDA (Cont'd)</b>													
<b>626 (Cont'd)</b>													
1997	V6 2.5L		<b>ZFR5F-11</b>	<b>2262</b>	FR5AHX	95839	ZFR5FIX-11	2477	ZFR5FGP	7098	ZFR5F-11	2262	.044
1996-93	L4 2.0L		<b>BKR5E-11</b>	<b>6953</b>			BKR5EIX-11	5464	BKR5EGP	7090	BKR5E-11	6953	.044
	V6 2.5L		<b>ZFR5F-11</b>	<b>2262</b>			ZFR5FIX-11	2477	ZFR5FGP	7098	ZFR5F-11	2262	.044
1992-90	L4 2.2L		<b>ZFR6F-11</b>	<b>4291</b>			ZFR6FIX-11	6441	ZFR6FGP	7100	ZFR6F-11	4291	.044
1989-88	L4 2.2L		<b>ZFR6A-11</b>	<b>1041</b>					ZFR6AGP	7094	ZFR6A-11	1041	.044
1987-86	L4 2.0L	Naturally Aspirated	<b>BPR5ES</b>	<b>7734</b>			BPR5EIX	6597	BPR5EGP	7082	BPR5EY	1233	.032
		Turbo	<b>BPR6ES</b>	<b>7131</b>			BPR6EIX	6637	BPR6EGP	7084	BPR6EY	6427	.032
1985	L4 2.0L	DIESEL	Y-107R	1229									
		GAS	<b>BPR5ES</b>	<b>7734</b>			BPR5EIX	6597	BPR5EGP	7082	BPR5EY	1233	.032
<b>929</b>													
1995-92	V6 3.0L		BKR5ES-11	2382			BKR5EIX-11	5464	BKR5EGP	7090	BKR5E-11	6953	.044
1991-90	V6 3.0L	DOHC	<b>ZFR5F-11</b>	<b>2262</b>			ZFR5FIX-11	2477	ZFR5FGP	7098	ZFR5F-11	2262	.044
		SOHC	<b>ZFR6A-11</b>	<b>1041</b>					ZFR6AGP	7094	ZFR6A-11	1041	.044
1989-88	V6 3.0L		<b>ZFR6A-11</b>	<b>1041</b>					ZFR6AGP	7094	ZFR6A-11	1041	.044
<b>B2000</b>													
1987-86	L4 2.0L		<b>BPR5ES</b>	<b>7734</b>			BPR5EIX	6597	BPR5EGP	7082	BPR5EY	1233	.032
<b>B2200</b>													
1993-90	L4 2.2L	CARB	<b>BPR5ES</b>	<b>7734</b>			BPR5EIX	6597	BPR5EGP	7082	BPR5EY	1233	.032
		FI	<b>BPR5ES-11</b>	<b>7634</b>			BPR5EIX-11	2115	BPR5EGP	7082	BPR5EY-11	6937	.044
1989-87	L4 2.2L		<b>BPR5ES</b>	<b>7734</b>			BPR5EIX	6597	BPR5EGP	7082	BPR5EY	1233	.032
<b>B2300</b>													
2010-01	L4 2.3L		<b>PTR5F-11</b>	<b>6579</b>			TR5IX	7397	TR5GP	3186	TR5	2238	.044
1997-94	L4 2.3L	Dual Plug; 8 Req'd	PTR5F-11	6579			TR5IX	7397	TR5GP	3186	TR5	2238	.044
<b>B2500</b>													
2001-98	L4 2.5L	Dual Plug; 8 Req'd	PTR5F-11	6579			TR5IX	7397	TR5GP	3186	TR5	2238	.044
<b>B2600</b>													
1993-90	L4 2.6L		<b>ZFR5F-11</b>	<b>2262</b>			ZFR5FIX-11	2477	ZFR5FGP	7098	ZFR5F-11	2262	.044
1989	L4 2.6L		<b>ZFR6A-11</b>	<b>1041</b>					ZFR6AGP	7094	ZFR6A-11	1041	.044
1988-87	L4 2.6L		<b>BPR5ES-11</b>	<b>7634</b>			BPR5EIX-11	2115	BPR5EGP	7082	BPR5EY-11	6937	.044
<b>B3000</b>													
2008-04	V6 3.0L		PTR5C-13	7740			TR55IX	7164	TR55GP	3403	TR55	3951	.052
2003	V6 3.0L		PTR5F-11	6579			TR5IX	7397	TR5GP	3186	TR5	2238	.044
2002-94	V6 3.0L		PTR5C-13	7740			TR5IX	7397	TR5GP	3186	TR5	2238	.044
<b>B4000</b>													
2010-06	V6 4.0L		TR55-1	2683			TR55-1IX	7316	TR55-1GP	7159	TR55-1	2683	.054
2005-04	V6 4.0L		TR55-1GP	7159			TR55-1IX	7316	TR55-1GP	7159	TR55-1	2683	.054
2003	V6 4.0L		PTR5C-13	7740			TR55IX	7164	TR55GP	3403	TR55	3951	.054
2002-01	V6 4.0L	Vin E	TR55-1GP	7159			TR55-1IX	7316	TR55-1GP	7159	TR55-1	2683	.054
2000-97	V6 4.0L		PTR6D-13	5598			TR65IX	3692	TR6GP	5141	TR6	4177	.054
1996-94	V6 4.0L		PTR5C-13	7740			TR55IX	7164	TR55GP	3403	TR55	3951	.054
<b>CX-3</b>													
2017-16	L4 2.0L		<b>ILKAR7L11</b>	<b>94124</b>	LKAR7AHX-S	92274	LKAR7BIX-11S	93501	LKAR7AGP-D	93220			.044
<b>CX-5</b>													
2017	L4 2.5L		<b>ILKAR7L11</b>	<b>94124</b>	LKAR7AHX-S	92274	LKAR7BIX-11S	93501	LKAR7AGP-D	93220			.044
2016-14	L4 2.0L		<b>ILKAR7L11</b>	<b>94124</b>	LKAR7AHX-S	92274	LKAR7BIX-11S	93501	LKAR7AGP-D	93220			.044
	L4 2.5L		<b>ILKAR7L11</b>	<b>94124</b>	LKAR7AHX-S	92274	LKAR7BIX-11S	93501	LKAR7AGP-D	93220			.044
2013	L4 2.0L		<b>ILKAR7L11</b>	<b>94124</b>	LKAR7AHX-S	92274	LKAR7BIX-11S	93501	LKAR7AGP-D	93220			.044
<b>CX-7</b>													
2012-10	L4 2.3L		<b>SILTR6A7G</b>	<b>95369</b>	LTR6BHX	90495							.027
	L4 2.5L		<b>LTR5BI-13</b>	<b>90083</b>	LTR5AHX	90220	LTR5IX-11	4344	LTR5GP	5019			.052
2009-07	L4 2.3L		<b>ILTR6A-8G</b>	<b>3787</b>	LTR6BHX	90495	LTR6IX	94374	LTR6GP-8	94372			.032
<b>CX-9</b>													
2015-08	V6 3.7L		PLTR6A-10G	3587	LTR6AHX	91276	LTR6IX-11	6509	LTR6GP	90198			.044
2007	V6 3.5L		PLTR6A-10G	3587	LTR6AHX	91276	LTR6IX-11	6509	LTR6GP	90198			.044
<b>GLC</b>													
1985	L4 1.5L		<b>BPR5ES</b>	<b>7734</b>			BPR5EIX	6597	BPR5EGP	7082	BPR5EY	1233	.032

**Bold denotes NGK OE Manufacturer and/or OE Service Part**  
NOT BOLD denotes OE Equivalent Part

**Le texte en gras désigne une pièce d'équipement originale du manufacturier NGK et/ou pièce d'équipement originale de service**  
Le texte non en gras désigne une pièce d'équipement originale équivalente

Note: Due to different operating or engine conditions, alternate heat range plugs may be required.

Note: En raison de différences au niveau du fonctionnement ou des conditions du moteur, d'autres types de bougies avec variation de chaleur peuvent être nécessaires



Year	Cyl. L	Notes	Original Equipment		Ruthenium HX		Iridium IX		G-Power		V-Power		Gap
			Part	Stock	Part	Stock	Part	Stock	Part	Stock	Part	Stock	
<b>MAZDA (Cont'd)</b>													
<b>Miata</b>													
2005-04	L4 1.8L	Naturally Aspirated	<b>BKR5E-11</b>	<b>6953</b>	FR5BHX	96457	BKR5EIX-11	5464	BKR5EGP	7090	BKR5E-11	6953	.044
		Turbo	<b>IFR5T-8N</b>	<b>3508</b>	FR5BHX	96457	BKR5EIX	6341	BKR5EGP	7090	BKR5E	7938	.032
2003-99	L4 1.8L		<b>BKR5E-11</b>	<b>6953</b>	FR5BHX	96457	BKR5EIX-11	5464	BKR5EGP	7090	BKR5E-11	6953	.044
1997	L4 1.8L		<b>BKR5E-11</b>	<b>6953</b>	FR5BHX	96457	BKR5EIX-11	5464	BKR5EGP	7090	BKR5E-11	6953	.044
1996-94	L4 1.8L		<b>BKR5E-11</b>	<b>6953</b>			BKR5EIX-11	5464	BKR5EGP	7090	BKR5E-11	6953	.044
1993-90	L4 1.6L		<b>BKR6E-11</b>	<b>2756</b>			BKR6EIX-11	3764	BKR6EGP	7092	BKR6E-11	2756	.044
<b>Millenia</b>													
2002-97	V6 2.3L		<b>PZFR5F</b>	<b>3741</b>	FR5BHX	96457	ZFR5FIX-11	2477	ZFR5FGP	7098	ZFR5F	7558	.032
	V6 2.5L		<b>ZFR5F-11</b>	<b>2262</b>	FR5AHX	95839	ZFR5FIX-11	2477	ZFR5FGP	7098	ZFR5F-11	2262	.044
1996-95	V6 2.3L		<b>PZFR5F</b>	<b>3741</b>			ZFR5FIX-11	2477	ZFR5FGP	7098	ZFR5F	7558	.032
	V6 2.5L		<b>ZFR5F-11</b>	<b>2262</b>			ZFR5FIX-11	2477	ZFR5FGP	7098	ZFR5F-11	2262	.044
<b>MPV</b>													
2006-02	V6 3.0L		TR5AI-13	90813	TR5AHX	94567	TR55IX	7164	TR55GP	3403	TR55	3951	.054
2001-00	V6 2.5L		PTR5C-13	7740			TR5IX	7397	TR5GP	3186	TR5	2238	.044
1998-97	V6 3.0L		<b>BKR5E-11</b>	<b>6953</b>	FR5AHX	95839	BKR5EIX-11	5464	BKR5EGP	7090	BKR5E-11	6953	.044
1996	V6 3.0L		<b>BKR5E-11</b>	<b>6953</b>			BKR5EIX-11	5464	BKR5EGP	7090	BKR5E-11	6953	.044
1995	V6 3.0L		<b>ZFR5F-11</b>	<b>2262</b>			ZFR5FIX-11	2477	ZFR5FGP	7098	ZFR5F-11	2262	.044
1994-90	L4 2.6L		<b>ZFR5F-11</b>	<b>2262</b>			ZFR5FIX-11	2477	ZFR5FGP	7098	ZFR5F-11	2262	.044
	V6 3.0L		<b>ZFR5F-11</b>	<b>2262</b>			ZFR5FIX-11	2477	ZFR5FGP	7098	ZFR5F-11	2262	.044
1989	L4 2.6L		<b>ZFR6A-11</b>	<b>1041</b>					ZFR6AGP	7094	ZFR6A-11	1041	.044
	V6 3.0L		<b>ZFR6A-11</b>	<b>1041</b>					ZFR6AGP	7094	ZFR6A-11	1041	.044
<b>MX-3</b>													
1996	L4 1.6L		<b>BKR5E-11</b>	<b>6953</b>			BKR5EIX-11	5464	BKR5EGP	7090	BKR5E-11	6953	.044
1995-92	L4 1.6L		<b>BKR5E-11</b>	<b>6953</b>			BKR5EIX-11	5464	BKR5EGP	7090	BKR5E-11	6953	.044
	V6 1.8L		<b>BKR5E-11</b>	<b>6953</b>			BKR5EIX-11	5464	BKR5EGP	7090	BKR5E-11	6953	.044
<b>MX-5 Miata</b>													
2017-16	L4 2.0L		<b>ILKAR7L11</b>	<b>94124</b>	LKAR7AHX-S	92274	LKAR7BIX-11S	93501	LKAR7AGP-D	93220			.044
2015-06	L4 2.0L		<b>LTR6BI-13</b>	<b>91725</b>	LTR6AHX	91276							.052
<b>MX-6</b>													
1997	L4 2.0L		<b>BKR5E-11</b>	<b>6953</b>	FR5AHX	95839	BKR5EIX-11	5464	BKR5EGP	7090	BKR5E-11	6953	.044
	V6 2.5L		<b>ZFR5F-11</b>	<b>2262</b>	FR5AHX	95839	ZFR5FIX-11	2477	ZFR5FGP	7098	ZFR5F-11	2262	.044
1996-93	L4 2.0L		<b>BKR5E-11</b>	<b>6953</b>			BKR5EIX-11	5464	BKR5EGP	7090	BKR5E-11	6953	.044
	V6 2.5L		<b>ZFR5F-11</b>	<b>2262</b>			ZFR5FIX-11	2477	ZFR5FGP	7098	ZFR5F-11	2262	.044
1992-90	L4 2.2L		<b>ZFR6F-11</b>	<b>4291</b>			ZFR6FIX-11	6441	ZFR6FGP	7100	ZFR6F-11	4291	.044
1989-88	L4 2.2L		<b>ZFR6A-11</b>	<b>1041</b>					ZFR6AGP	7094	ZFR6A-11	1041	.044
<b>Navajo</b>													
1994-91	V6 4.0L		PTR5C-13	7740			TR55IX	7164	TR55GP	3403	TR55	3951	.054
<b>Protege</b>													
2003	L4 1.6L		<b>ZFR5F-11</b>	<b>2262</b>	FR5BHX	96457	ZFR5FIX-11	2477	ZFR5FGP	7098	ZFR5F-11	2262	.044
	L4 2.0L	Naturally Aspirated	<b>BKR5E-11</b>	<b>6953</b>	FR5BHX	96457	BKR5EIX-11	5464	BKR5EGP	7090	BKR5E-11	6953	.044
		Turbo	<b>PZFR6F-11</b>	<b>3271</b>	FR6BHX-S	95159	ZFR6FIX-11	6441	ZFR6FGP	7100	ZFR6F-11	4291	.044
2002-01	L4 1.6L		<b>ZFR5F-11</b>	<b>2262</b>	FR5BHX	96457	ZFR5FIX-11	2477	ZFR5FGP	7098	ZFR5F-11	2262	.044
	L4 2.0L		<b>BKR5E-11</b>	<b>6953</b>	FR5BHX	96457	BKR5EIX-11	5464	BKR5EGP	7090	BKR5E-11	6953	.044
2000-99	L4 1.6L		<b>ZFR5F-11</b>	<b>2262</b>	FR5BHX	96457	ZFR5FIX-11	2477	ZFR5FGP	7098	ZFR5F-11	2262	.044
	L4 1.8L		<b>BKR5E-11</b>	<b>6953</b>	FR5BHX	96457	BKR5EIX-11	5464	BKR5EGP	7090	BKR5E-11	6953	.044
1998-97	L4 1.5L		<b>BKR5E-11</b>	<b>6953</b>	FR5AHX	95839	BKR5EIX-11	5464	BKR5EGP	7090	BKR5E-11	6953	.044
	L4 1.8L		<b>BKR5E-11</b>	<b>6953</b>	FR5AHX	95839	BKR5EIX-11	5464	BKR5EGP	7090	BKR5E-11	6953	.044
1996-95	L4 1.5L		<b>BKR5E-11</b>	<b>6953</b>			BKR5EIX-11	5464	BKR5EGP	7090	BKR5E-11	6953	.044
	L4 1.8L		<b>BKR5E-11</b>	<b>6953</b>			BKR5EIX-11	5464	BKR5EGP	7090	BKR5E-11	6953	.044
1994-92	L4 1.8L	DOHC	<b>BKR6E-11</b>	<b>2756</b>			BKR6EIX-11	3764	BKR6EGP	7092	BKR6E-11	2756	.044
		SOHC	<b>BKR5E-11</b>	<b>6953</b>			BKR5EIX-11	5464	BKR5EGP	7090	BKR5E-11	6953	.044
1991	L4 1.8L	4WD	<b>BKR5E-11</b>	<b>6953</b>			BKR5EIX-11	5464	BKR5EGP	7090	BKR5E-11	6953	.044
		DX	<b>BKR5E-11</b>	<b>6953</b>			BKR5EIX-11	5464	BKR5EGP	7090	BKR5E-11	6953	.044
		GT	<b>BKR5E-11</b>	<b>6953</b>			BKR5EIX-11	5464	BKR5EGP	7090	BKR5E-11	6953	.044
		LX	<b>BKR6E-11</b>	<b>2756</b>			BKR6EIX-11	3764	BKR6EGP	7092	BKR6E-11	2756	.044
1990	L4 1.8L	4WD	<b>BKR5E-11</b>	<b>6953</b>			BKR5EIX-11	5464	BKR5EGP	7090	BKR5E-11	6953	.044
		GT	<b>BKR5E-11</b>	<b>6953</b>			BKR5EIX-11	5464	BKR5EGP	7090	BKR5E-11	6953	.044



Year	Cyl. L	Notes	Original Equipment		Ruthenium HX		Iridium IX		G-Power		V-Power		Gap
			Part	Stock	Part	Stock	Part	Stock	Part	Stock	Part	Stock	
<b>MAZDA (Cont'd)</b>													
<b>Protege (Cont'd)</b>													
1990		LX	<b>BKR6E-11</b>	<b>2756</b>			BKR6EIX-11	3764	BKR6EGP	7092	BKR6E-11	2756	.044
		SE	<b>BKR5E-11</b>	<b>6953</b>			BKR5EIX-11	5464	BKR5EGP	7090	BKR5E-11	6953	.044
<b>Protege5</b>													
2003-02	L4 2.0L		<b>BKR5E-11</b>	<b>6953</b>	FR5BHX	96457	BKR5EIX-11	5464	BKR5EGP	7090	BKR5E-11	6953	.044
<b>RX-7</b>													
1995-93	R2 1.3L	Dual Plug; Leading (2 Req'd)	<b>BUR7EQP</b>	<b>4764</b>									.055
		Dual Plug; Trailing (2 Req'd)	<b>BUR9EQP</b>	<b>5255</b>									.055
1991-86	R2 1.3L	Dual Plug; Leading (2 Req'd)	<b>BUR7EQ</b>	<b>6917</b>									.055
		Dual Plug; Trailing (2 Req'd)	<b>BUR9EQ</b>	<b>5777</b>									.055
1985	R2 1.1L	Dual Plug; 4 Req'd	<b>BR8EQ-14</b>	<b>2329</b>									.055
	R2 1.3L	Dual Plug (4 Req'd); Optional Cold Climate Spark Plug	<b>BUR9EQ</b>	<b>5777</b>									.055
		Dual Plug (4 Req'd); Standard OE Spark Plug	<b>BR9EQ-14</b>	<b>3129</b>									.055
<b>RX-8</b>													
2011-04	R2 1.3L	Dual Plug; Leading (2 Req'd)	<b>RE7C-L</b>	<b>6700</b>									.048
		Dual Plug; Trailing (2 Req'd)	<b>RE9B-T</b>	<b>6701</b>									.048
<b>Tribute</b>													
2011-09	L4 2.5L		<b>LTR5BI-13</b>	<b>90083</b>	LTR5AHX	90220	LTR5IX-11	4344	LTR5GP	5019			.052
	V6 3.0L		<b>TR5C-12</b>	<b>92838</b>	TR5AHX	94567	TR5IX	7397	TR5GP	3186	TR5	2238	.048
2008	L4 2.3L		<b>TR5AI-13</b>	<b>90813</b>	TR5AHX	94567	TR55IX	7164	TR55GP	3403	TR55	3951	.054
	V6 3.0L		PTR5C-13	7740	TR5AHX	94567	TR55IX	7164	TR55GP	3403	TR55	3951	.054
2006-05	L4 2.3L		<b>TR5AI-13</b>	<b>90813</b>	TR5AHX	94567	TR55IX	7164	TR55GP	3403	TR55	3951	.054
	V6 3.0L		PTR5C-13	7740	TR5AHX	94567	TR55IX	7164	TR55GP	3403	TR55	3951	.054
2004-01	L4 2.0L		PTR5A-13	2467			LTR5IX-11	4344	LTR5GP	5019			.050
	V6 3.0L		PTR5C-13	7740	TR5AHX	94567	TR55IX	7164	TR55GP	3403	TR55	3951	.054
<b>MERCEDES-BENZ</b>													
<b>190D</b>													
1989-88	L5 2.5L	DIESEL	Y-924J	3473									
1987	L5 2.5L	DIESEL, Naturally Aspirated	Y-924J	3473									
		DIESEL, Turbo	Y-918J	3704									
1986	L5 2.5L	DIESEL	Y-924J	3473									
1985	L4 2.2L	DIESEL	Y-924J	3473									
<b>190E</b>													
1993-91	L4 2.3L		TR5	2238			TR5IX	7397	TR5GP	3186	TR5	2238	.030
	L6 2.6L		TR5	2238			TR5IX	7397	TR5GP	3186	TR5	2238	.030
1990-89	L6 2.6L		TR5	2238			TR5IX	7397	TR5GP	3186	TR5	2238	.030
1988-87	L4 2.3L		TR5	2238			TR5IX	7397	TR5GP	3186	TR5	2238	.030
	L6 2.6L		TR5	2238			TR5IX	7397	TR5GP	3186	TR5	2238	.030
1986-85	L4 2.3L		TR5	2238			TR5IX	7397	TR5GP	3186	TR5	2238	.030
<b>260E</b>													
1989-87	L6 2.6L		TR5	2238			TR5IX	7397	TR5GP	3186	TR5	2238	.030
<b>300CD</b>													
1985	L5 3.0L	DIESEL	Y-924J	3473									
<b>300CE</b>													
1993	L6 3.2L		BKR5E	7938			BKR5EIX	6341	BKR5EGP	7090	BKR5E	7938	.032
1992-90	L6 3.0L		BKR5E	7938			BKR5EIX	6341	BKR5EGP	7090	BKR5E	7938	.032
1989-88	L6 3.0L		TR5	2238			TR5IX	7397	TR5GP	3186	TR5	2238	.030
<b>300D</b>													
1993-90	L5 2.5L	DIESEL	Y-918J	3704									
1987	L6 3.0L	DIESEL	Y-924J	3473									
1985	L5 3.0L	DIESEL	Y-924J	3473									

**Bold denotes NGK OE Manufacturer and/or OE Service Part**  
NOT BOLD denotes OE Equivalent Part

**Le texte en gras désigne une pièce d'équipement originale du manufacturier NGK et/ou pièce d'équipement originale de service**  
Le texte non en gras désigne une pièce d'équipement originale équivalente

Note: Due to different operating or engine conditions, alternate heat range plugs may be required.

Note: En raison de différences au niveau du fonctionnement ou des conditions du moteur, d'autres types de bougies avec variation de chaleur peuvent être nécessaires



Year	Cyl. L	Notes	Original Equipment		Ruthenium HX		Iridium IX		G-Power		V-Power		Gap
			Part	Stock	Part	Stock	Part	Stock	Part	Stock	Part	Stock	
<b>MERCEDES-BENZ (Cont'd)</b>													
<b>300E</b>													
1993	L6 2.8L		BKR5E	7938			BKR5EIX	6341	BKR5EGP	7090	BKR5E	7938	.032
	L6 3.0L		TR5	2238			TR5IX	7397	TR5GP	3186	TR5	2238	.030
	L6 3.2L		BKR5E	7938			BKR5EIX	6341	BKR5EGP	7090	BKR5E	7938	.032
1992-90	L6 2.6L		TR5	2238			TR5IX	7397	TR5GP	3186	TR5	2238	.030
	L6 3.0L		TR5	2238			TR5IX	7397	TR5GP	3186	TR5	2238	.030
1989-86	L6 3.0L		TR5	2238			TR5IX	7397	TR5GP	3186	TR5	2238	.030
<b>300SD</b>													
1993-92	L6 3.4L	DIESEL	Y-918J	3704									
1985	L5 3.0L	DIESEL	Y-924J	3473									
<b>300SDL</b>													
1987-86	L6 3.0L	DIESEL	Y-924J	3473									
<b>300SE</b>													
1993-92	L6 3.2L		BKR5E	7938			BKR5EIX	6341	BKR5EGP	7090	BKR5E	7938	.032
1991-88	L6 3.0L		TR5	2238			TR5IX	7397	TR5GP	3186	TR5	2238	.030
<b>300SEL</b>													
1991-88	L6 3.0L		TR5	2238			TR5IX	7397	TR5GP	3186	TR5	2238	.030
<b>300SL</b>													
1993-90	L6 3.0L		BKR5E	7938			BKR5EIX	6341	BKR5EGP	7090	BKR5E	7938	.032
<b>300TD</b>													
1987	L6 3.0L	DIESEL	Y-924J	3473									
1985	L5 3.0L	DIESEL	Y-924J	3473									
<b>300TE</b>													
1993	L6 3.0L		TR5	2238			TR5IX	7397	TR5GP	3186	TR5	2238	.030
	L6 3.2L		BKR5E	7938			BKR5EIX	6341	BKR5EGP	7090	BKR5E	7938	.032
1992-88	L6 3.0L		TR5	2238			TR5IX	7397	TR5GP	3186	TR5	2238	.030
<b>350SD</b>													
1991	L6 3.4L	DIESEL	Y-918J	3704									
<b>350SDL</b>													
1991	L6 3.4L	DIESEL	Y-918J	3704									
1990	L6 3.4L	DIESEL	Y-924J	3473									
<b>380SE</b>													
1985	V8 3.8L		BPR5ES	7734			BPR5EIX	6597	BPR5EGP	7082	BPR5EY	1233	.032
<b>380SL</b>													
1985	V8 3.8L		BPR5ES	7734			BPR5EIX	6597	BPR5EGP	7082	BPR5EY	1233	.032
<b>400E</b>													
1993-92	V8 4.2L		BKR5E	7938			BKR5EIX	6341	BKR5EGP	7090	BKR5E	7938	.032
<b>400SE</b>													
1992	V8 4.2L		BKR5E	7938			BKR5EIX	6341	BKR5EGP	7090	BKR5E	7938	.032
<b>400SEL</b>													
1993	V8 4.2L		BKR5E	7938			BKR5EIX	6341	BKR5EGP	7090	BKR5E	7938	.032
<b>420SEL</b>													
1991-86	V8 4.2L		BPR5ES	7734			BPR5EIX	6597	BPR5EGP	7082	BPR5EY	1233	.032
<b>500E</b>													
1993-92	V8 5.0L		BKR5E	7938			BKR5EIX	6341	BKR5EGP	7090	BKR5E	7938	.032
<b>500SEC</b>													
1993	V8 5.0L		BKR5E	7938			BKR5EIX	6341	BKR5EGP	7090	BKR5E	7938	.032
1985	V8 5.0L		BPR5ES	7734			BPR5EIX	6597	BPR5EGP	7082	BPR5EY	1233	.032
<b>500SEL</b>													
1993-92	V8 5.0L		BKR5E	7938			BKR5EIX	6341	BKR5EGP	7090	BKR5E	7938	.032
1985	V8 5.0L		BPR5ES	7734			BPR5EIX	6597	BPR5EGP	7082	BPR5EY	1233	.032
<b>500SL</b>													
1993-90	V8 5.0L		BKR5E	7938			BKR5EIX	6341	BKR5EGP	7090	BKR5E	7938	.032
<b>560SEC</b>													
1991-86	V8 5.6L		BPR5ES	7734			BPR5EIX	6597	BPR5EGP	7082	BPR5EY	1233	.032
<b>560SEL</b>													
1991-86	V8 5.6L		BPR5ES	7734			BPR5EIX	6597	BPR5EGP	7082	BPR5EY	1233	.032





Year	Cyl. L	Notes	Original Equipment		Ruthenium HX		Iridium IX		G-Power		V-Power		Gap
			Part	Stock	Part	Stock	Part	Stock	Part	Stock	Part	Stock	
<b>MERCEDES-BENZ (Cont'd)</b>													
<b>560SL</b>													
1989-86	V8 5.6L		BPR5ES	7734			BPR5EIX	6597	BPR5EGP	7082	BPR5EY	1233	.032
<b>600SEC</b>													
1993	V12 6.0L		BKR5E	7938			BKR5EIX	6341	BKR5EGP	7090	BKR5E	7938	.032
<b>600SEL</b>													
1993-92	V12 6.0L		BKR5E	7938			BKR5EIX	6341	BKR5EGP	7090	BKR5E	7938	.032
<b>600SL</b>													
1993	V12 6.0L		BKR5E	7938			BKR5EIX	6341	BKR5EGP	7090	BKR5E	7938	.032
<b>B200</b>													
2011-06	L4 2.0L	Naturally Aspirated	<b>BKR6EZB</b>	<b>4293</b>	FR6BHX-S	95159					BKR6EZB	4293	.036
<b>B250</b>													
2018-13	L4 2.0L		<b>SILZKFR8E7S</b>	<b>90654</b>									.028
<b>C32 AMG</b>													
2004-03	V6 3.2L	Dual Plug; 12 Req'd	<b>IFR6D10</b>	<b>5344</b>	FR6BHX-S	95159	BKR6EIX-11	3764	BKR6EGP	7092	BKR6E-11	2756	.040
2002	V6 3.2L	Dual Plug; 12 Req'd	<b>IFR6D10</b>	<b>5344</b>	FR6BHX-S	95159	BKR6EIX	6418	BKR6EGP	7092	BKR6E-11	2756	.040
<b>C36 AMG</b>													
1997	L6 3.6L		BKR5E	7938	FR5BHX	96457	BKR5EIX	6341	BKR5EGP	7090	BKR5E	7938	.032
1996-95	L6 3.6L		BKR5E	7938			BKR5EIX	6341	BKR5EGP	7090	BKR5E	7938	.032
<b>C43 AMG</b>													
2000-98	V8 4.3L	Dual Plug; 16 Req'd	<b>PFR5R-11</b>	<b>4292</b>	FR5AHX	95839	BKR5EIX-11	5464	BKR5EGP	7090	BKR5E	7938	.044
<b>C55 AMG</b>													
2006-05	V8 5.5L	Dual Plug; 16 Req'd	<b>IFR6D10</b>	<b>5344</b>	FR6AHX-S	94279	BKR6EIX-11	3764	BKR6EGP	7092	BKR6E-11	2756	.040
<b>C63 AMG</b>													
2015-08	V8 6.3L		<b>ILZKAR7A10</b>	<b>6043</b>									.039
<b>C220</b>													
1996-94	L4 2.2L		BKR5E	7938			BKR5EIX	6341	BKR5EGP	7090	BKR5E	7938	.032
<b>C230</b>													
2009-06	V6 2.5L		<b>PLKR7A</b>	<b>4288</b>	LKR7BHX	94705	LKR7AIX	93911	LKR7BGP-8	95983			.032
2005-03	L4 1.8L		ILFR6A	3588	LFR6BHX	93420	LFR6AIX	93893	LFR6CGP	1483			.032
2002	L4 2.3L		<b>IFR6D10</b>	<b>5344</b>	FR6BHX-S	95159	BKR6EIX	6418	BKR6EGP	7092	BKR6E-11	2756	.040
2000-99	L4 2.3L		BKUR6ET-10	2397	FR6BHX-S	95159							.040
1998	L4 2.3L		BKR5ES	2460	FR5BHX	96457	BKR5EIX	6341	BKR5EGP	7090	BKR5E	7938	.032
1997	L4 2.3L		BKR5E	7938	FR5BHX	96457	BKR5EIX	6341	BKR5EGP	7090	BKR5E	7938	.032
<b>C240</b>													
2005-03	V6 2.6L	Dual Plug; 12 Req'd	PFR5R-11	4292	FR5AHX	95839	BKR5EIX-11	5464	BKR5EGP	7090	BKR5E-11	6953	.044
2002-01	V6 2.6L	Dual Plug; 12 Req'd	<b>PFR5R-11</b>	<b>4292</b>	FR5AHX	95839	BKR5EIX-11	5464	BKR5EGP	7090	BKR5E	7938	.044
<b>C250</b>													
2015-14	L4 1.8L		<b>PLKR7B8E</b>	<b>94716</b>	LKR7BHX	94705							.032
2013	L4 1.8L		<b>PLKR7B8E</b>	<b>94716</b>	LKR7BHX	94705	LKR7AIX	93911					.032
2012	L4 1.8L		<b>PLKR7B8E</b>	<b>94716</b>	LKR7BHX	94705	LKR7AIX	93911					.032
	V6 2.5L		PLKR7A	4288	LKR7BHX	94705	LKR7AIX	93911	LKR7BGP-8	95983			.032
2011-10	V6 2.5L		PLKR7A	4288	LKR7BHX	94705	LKR7AIX	93911	LKR7BGP-8	95983			.032
<b>C280</b>													
2007-06	V6 3.0L		PLKR7A	4288	LKR7BHX	94705	LKR7AIX	93911	LKR7BGP-8	95983			.032
2000-99	V6 2.8L	Dual Plug; 12 Req'd	<b>PFR5R-11</b>	<b>4292</b>	FR5AHX	95839	BKR5EIX-11	5464	BKR5EGP	7090	BKR5E	7938	.044
1998	V6 2.8L	Dual Plug; 12 Req'd	PFR5R-11	4292	FR5AHX	95839	BKR5EIX-11	5464	BKR5EGP	7090	BKR5E-11	6953	.040
1997	L6 2.8L		BKR5E	7938	FR5BHX	96457	BKR5EIX	6341	BKR5EGP	7090	BKR5E	7938	.032
1996-94	L6 2.8L		BKR5E	7938			BKR5EIX	6341	BKR5EGP	7090	BKR5E	7938	.032
<b>C300</b>													
2018-15	L4 2.0L		<b>SILZKFR8E7S</b>	<b>90654</b>									.028
2014-13	V6 3.5L	GAS	SILZKBR8D8S	97506									.028
2012-08	V6 3.0L		PLKR7A	4288	LKR7BHX	94705	LKR7AIX	93911	LKR7BGP-8	95983			.032
<b>C320</b>													
2005-03	V6 3.2L	Dual Plug; 12 Req'd	PFR5R-11	4292	FR5AHX	95839	BKR5EIX-11	5464	BKR5EGP	7090	BKR5E-11	6953	.044
2002	V6 3.2L	Dual Plug; 12 Req'd	PFR5R-11	4292	FR5AHX	95839	BKR5EIX-11	5464	BKR5EGP	7090	BKR5E	7938	.044
2001	V6 3.2L	Dual Plug; 12 Req'd	<b>PFR5R-11</b>	<b>4292</b>	FR5AHX	95839	BKR5EIX-11	5464	BKR5EGP	7090	BKR5E	7938	.044
<b>C350</b>													
2016-15	V6 3.5L		SILZKBR8D8S	97506									.028

**Bold denotes NGK OE Manufacturer and/or OE Service Part**  
NOT BOLD denotes OE Equivalent Part

**Le texte en gras désigne une pièce d'équipement originale du manufacturier NGK et/ou pièce d'équipement originale de service**  
Le texte non en gras désigne une pièce d'équipement originale équivalente

Note: Due to different operating or engine conditions, alternate heat range plugs may be required.

Note: En raison de différences au niveau du fonctionnement ou des conditions du moteur, d'autres types de bougies avec variation de chaleur peuvent être nécessaires



Year	Cyl. L	Notes	Original Equipment		Ruthenium HX		Iridium IX		G-Power		V-Power		Gap
			Part	Stock	Part	Stock	Part	Stock	Part	Stock	Part	Stock	
<b>MERCEDES-BENZ (Cont'd)</b>													
<b>C350 (Cont'd)</b>													
2014-12	V6 3.5L	GAS	SILZKBR8D8S	97506									.028
2011-06	V6 3.5L		PLKR7A	4288	LKR7BHX	94705	LKR7AIX	93911	LKR7BGP-8	95983			.032
<b>C350e</b>													
2018-16	L4 2.0L		<b>SILZKFR8E7S</b>	<b>90654</b>									.028
<b>CL55 AMG</b>													
2006-03	V8 5.5L	Dual Plug; 16 Req'd	<b>ILFR6A</b>	<b>3588</b>	LFR6BHX	93420	LFR6AIX	93893	LFR6CGP	1483			.032
2002-01	V8 5.5L	Dual Plug; 16 Req'd	<b>PFR5R-11</b>	<b>4292</b>	FR5AHX	95839	BKR5EIX-11	5464	BKR5EGP	7090	BKR5E	7938	.044
<b>CL63 AMG</b>													
2014-11	V8 5.5L		SILZKBR8D8S	97506									.028
2010-08	V8 6.3L		<b>ILZKAR7A10</b>	<b>6043</b>									.040
<b>CL65 AMG</b>													
2014-08	V12 6.0L	Dual Plug; 24 Req'd	<b>IFR6Q-G</b>	<b>5648</b>	FR6BHX-S	95159	BKR6EIX	6418	BKR6EGP	7092			.028
2006-05	V12 6.0L	Dual Plug; 24 Req'd	<b>IFR6Q-G</b>	<b>5648</b>	FR6BHX-S	95159	BKR6EIX	6418	BKR6EGP	7092			.028
<b>CL500</b>													
2006-03	V8 5.0L	Dual Plug; 16 Req'd	PFR5R-11	4292	FR5AHX	95839	BKR5EIX-11	5464	BKR5EGP	7090	BKR5E-11	6953	.039
2002-00	V8 5.0L	Dual Plug; 16 Req'd	<b>PFR5R-11</b>	<b>4292</b>	FR5AHX	95839	BKR5EIX-11	5464	BKR5EGP	7090	BKR5E	7938	.044
1999-98	V8 5.0L		PFR5R-11	4292	FR5AHX	95839	BKR5EIX-11	5464	BKR5EGP	7090	BKR5E	7938	.039
<b>CL550</b>													
2014-11	V8 4.6L		SILZKBR8D8S	97506									.028
2010-07	V8 5.5L		<b>PLKR7A</b>	<b>4288</b>	LKR7BHX	94705	LKR7AIX	93911	LKR7BGP-8	95983			.032
<b>CL600</b>													
2014-03	V12 5.5L	Dual Plug; 24 Req'd	<b>IFR6Q-G</b>	<b>5648</b>	FR6BHX-S	95159	BKR6EIX	6418	BKR6EGP	7092			.028
2002	V12 5.8L	Dual Plug; 24 Req'd	PFR6T-10G	5542	FR6AHX-S	94279	BKR6EIX-11	3764	BKR6EGP	7092	BKR6E-11	2756	.040
2001	V12 5.8L	Dual Plug; 24 Req'd	<b>PFR5R-11</b>	<b>4292</b>	FR5AHX	95839	BKR5EIX-11	5464	BKR5EGP	7090	BKR5E	7938	.044
1999-98	V12 6.0L		PFR5R-11	4292	FR5AHX	95839	BKR5EIX-11	5464	BKR5EGP	7090	BKR5E	7938	.039
<b>CLA45 AMG</b>													
2018-14	L4 2.0L		<b>SILZKFR8D7S</b>	<b>95875</b>									.028
<b>CLA250</b>													
2018-14	L4 2.0L		<b>SILZKFR8E7S</b>	<b>90654</b>									.028
<b>CLK55 AMG</b>													
2006-03	V8 5.5L	Dual Plug; 16 Req'd	<b>IFR6D10</b>	<b>5344</b>	FR6AHX-S	94279	BKR6EIX-11	3764	BKR6EGP	7092	BKR6E-11	2756	.040
2002-01	V8 5.5L	Dual Plug; 16 Req'd	<b>PFR5R-11</b>	<b>4292</b>	FR5AHX	95839	BKR5EIX-11	5464	BKR5EGP	7090	BKR5E	7938	.044
<b>CLK63 AMG</b>													
2009-07	V8 6.3L		<b>ILZKAR7A10</b>	<b>6043</b>									.040
<b>CLK320</b>													
2005-03	V6 3.2L	Dual Plug; 12 Req'd	PFR5R-11	4292	FR5AHX	95839	BKR5EIX-11	5464	BKR5EGP	7090	BKR5E-11	6953	.044
2002	V6 3.2L	Dual Plug; 12 Req'd	PFR5R-11	4292	FR5AHX	95839	BKR5EIX-11	5464	BKR5EGP	7090	BKR5E	7938	.044
2001-98	V6 3.2L	Dual Plug; 12 Req'd	<b>PFR5R-11</b>	<b>4292</b>	FR5AHX	95839	BKR5EIX-11	5464	BKR5EGP	7090	BKR5E	7938	.044
<b>CLK350</b>													
2009-06	V6 3.5L		PLKR7A	4288	LKR7BHX	94705	LKR7AIX	93911	LKR7BGP-8	95983			.032
<b>CLK430</b>													
2003	V8 4.3L	Dual Plug; 16 Req'd	PFR5R-11	4292	FR5AHX	95839	BKR5EIX-11	5464	BKR5EGP	7090	BKR5E-11	6953	.044
2002-99	V8 4.3L	Dual Plug; 16 Req'd	<b>PFR5R-11</b>	<b>4292</b>	FR5AHX	95839	BKR5EIX-11	5464	BKR5EGP	7090	BKR5E	7938	.044
<b>CLK500</b>													
2006-03	V8 5.0L	Dual Plug; 16 Req'd	PFR5R-11	4292	FR5AHX	95839	BKR5EIX-11	5464	BKR5EGP	7090	BKR5E-11	6953	.039
<b>CLK550</b>													
2009-07	V8 5.5L		<b>PLKR7A</b>	<b>4288</b>	LKR7BHX	94705	LKR7AIX	93911	LKR7BGP-8	95983			.032
<b>CLS55 AMG</b>													
2006	V8 5.5L	Dual Plug; 16 Req'd	<b>ILFR6A</b>	<b>3588</b>	LFR6BHX	93420	LFR6AIX	93893	LFR6CGP	1483			.032
<b>CLS63 AMG</b>													
2014-12	V8 5.5L		SILZKBR8D8S	97506									.028
2011-07	V8 6.3L		<b>ILZKAR7A10</b>	<b>6043</b>									.040
<b>CLS63 AMG S</b>													
2018-14	V8 5.5L		SILZKBR8D8S	97506									.028
<b>CLS500</b>													
2006	V8 5.0L	Dual Plug; 16 Req'd	PFR5R-11	4292	FR5AHX	95839	BKR5EIX-11	5464	BKR5EGP	7090	BKR5E-11	6953	.039



Year	Cyl. L	Notes	Original Equipment		Ruthenium HX		Iridium IX		G-Power		V-Power		Gap
			Part	Stock	Part	Stock	Part	Stock	Part	Stock	Part	Stock	
<b>MERCEDES-BENZ (Cont'd)</b>													
<b>CLS550</b>													
2018-12	V8 4.6L		SILZKBR8D8S	97506									.028
2011-07	V8 5.5L		<b>PLKR7A</b>	<b>4288</b>	LKR7BHX	94705	LKR7AIX	93911	LKR7BGP-8	95983			.032
<b>E55 AMG</b>													
2006-03	V8 5.5L	Dual Plug; 16 Req'd	<b>ILFR6A</b>	<b>3588</b>	LF6R6BHX	93420	LF6R6AIX	93893	LF6R6CGP	1483			.032
2002-99	V8 5.5L	Dual Plug; 16 Req'd	<b>PFR5R-11</b>	<b>4292</b>	FR5AHX	95839	BKR5EIX-11	5464	BKR5EGP	7090	BKR5E	7938	.044
<b>E63 AMG</b>													
2015-12	V8 5.5L		SILZKBR8D8S	97506									.028
2011-07	V8 6.3L		<b>ILZKAR7A10</b>	<b>6043</b>									.040
<b>E63 AMG S</b>													
2016-14	V8 5.5L		SILZKBR8D8S	97506									.028
<b>E250</b>													
2016-14	L4 2.1L	DIESEL	<b>CZ303</b>	<b>9970</b>									
<b>E280</b>													
2007	V6 3.0L		PLKR7A	4288	LKR7BHX	94705	LKR7AIX	93911	LKR7BGP-8	95983			.032
<b>E300</b>													
2018-17	L4 2.0L		<b>SILZKFR8E7S</b>	<b>90654</b>									.028
2016-14	V6 3.5L	w/12 point bi-hex spark plug	SILZKBR8D8S	97506									.028
2013-12	V6 3.5L		SILZKBR8D8S	97506									.028
2009-08	V6 3.0L		PLKR7A	4288	LKR7BHX	94705	LKR7AIX	93911	LKR7BGP-8	95983			.032
1999-96	L6 3.0L	DIESEL	Y-925J	5740									
1995	L6 3.0L	DIESEL, From 6/95	Y-925J	5740									
		DIESEL, To 5/95	Y-930U	5568									
<b>E320</b>													
2009-07	V6 3.0L	DIESEL	<b>CZ303</b>	<b>9970</b>									
2006	L6 3.2L	DIESEL	Y-745U	4705									
2005	L6 3.2L	DIESEL	Y-745U	4705									
		Dual Plug; 12 Req'd	PFR5R-11	4292	FR5AHX	95839	BKR5EIX-11	5464	BKR5EGP	7090	BKR5E-11	6953	.044
2004-03	V6 3.2L	Dual Plug; 12 Req'd	PFR5R-11	4292	FR5AHX	95839	BKR5EIX-11	5464	BKR5EGP	7090	BKR5E-11	6953	.044
2002	V6 3.2L	Dual Plug; 12 Req'd	PFR5R-11	4292	FR5AHX	95839	BKR5EIX-11	5464	BKR5EGP	7090	BKR5E	7938	.044
2001-98	V6 3.2L	Dual Plug; 12 Req'd	<b>PFR5R-11</b>	<b>4292</b>	FR5AHX	95839	BKR5EIX-11	5464	BKR5EGP	7090	BKR5E	7938	.044
1997	L6 3.2L		BKR5E	7938	FR5BHX	96457	BKR5EIX	6341	BKR5EGP	7090	BKR5E	7938	.032
1996-94	L6 3.2L		BKR5E	7938			BKR5EIX	6341	BKR5EGP	7090	BKR5E	7938	.032
<b>E350</b>													
2016-14	V6 3.5L	w/12 point bi-hex spark plug	SILZKBR8D8S	97506									.028
2013-12	V6 3.0L	DIESEL	<b>CZ303</b>	<b>9970</b>									
	V6 3.5L	GAS	SILZKBR8D8S	97506									.028
2011	V6 3.0L	DIESEL	<b>CZ159</b>	<b>92053</b>									
	V6 3.5L		PLKR7A	4288	LKR7BHX	94705	LKR7AIX	93911	LKR7BGP-8	95983			.032
2010-06	V6 3.5L		PLKR7A	4288	LKR7BHX	94705	LKR7AIX	93911	LKR7BGP-8	95983			.032
<b>E400</b>													
2015-14	V6 3.5L	w/12 point bi-hex spark plug	SILZKBR8D8S	97506									.028
2013	V6 3.5L		SILZKBR8D8S	97506									.028
<b>E420</b>													
1997	V8 4.2L		BKR5E	7938	FR5AHX	95839	BKR5EIX	6341	BKR5EGP	7090	BKR5E	7938	.032
1995-94	V8 4.2L		BKR5E	7938			BKR5EIX	6341	BKR5EGP	7090	BKR5E	7938	.032
<b>E430</b>													
2002-98	V8 4.3L	Dual Plug; 16 Req'd	<b>PFR5R-11</b>	<b>4292</b>	FR5AHX	95839	BKR5EIX-11	5464	BKR5EGP	7090	BKR5E	7938	.044
<b>E500</b>													
2006-03	V8 5.0L	Dual Plug; 16 Req'd	PFR5R-11	4292	FR5AHX	95839	BKR5EIX-11	5464	BKR5EGP	7090	BKR5E-11	6953	.039
1994	V8 5.0L		BKR5E	7938			BKR5EIX	6341	BKR5EGP	7090	BKR5E	7938	.032
<b>E550</b>													
2017-12	V8 4.6L		SILZKBR8D8S	97506									.028
2011-07	V8 5.5L		<b>PLKR7A</b>	<b>4288</b>	LKR7BHX	94705	LKR7AIX	93911	LKR7BGP-8	95983			.032
<b>G55 AMG</b>													
2011-05	V8 5.5L	Dual Plug; 16 Req'd	<b>ILFR6A</b>	<b>3588</b>	LF6R6BHX	93420	LF6R6AIX	93893	LF6R6CGP	1483			.032

**Bold denotes NGK OE Manufacturer and/or OE Service Part**  
NOT BOLD denotes OE Equivalent Part

**Le texte en gras désigne une pièce d'équipement originale du manufacturier NGK et/ou pièce d'équipement originale de service**  
Le texte non en gras désigne une pièce d'équipement originale équivalente

Note: Due to different operating or engine conditions, alternate heat range plugs may be required.

Note: En raison de différences au niveau du fonctionnement ou des conditions du moteur, d'autres types de bougies avec variation de chaleur peuvent être nécessaires



Year	Cyl. L	Notes	Original Equipment		Ruthenium HX		Iridium IX		G-Power		V-Power		Gap
			Part	Stock	Part	Stock	Part	Stock	Part	Stock	Part	Stock	
<b>MERCEDES-BENZ (Cont'd)</b>													
<b>G55 AMG (Cont'd)</b>													
2004-03	V8 5.5L	Dual Plug; 16 Req'd	PFR5R-11	4292	FR5AHX	95839	BKR5EIX-11	5464	BKR5EGP	7090	BKR5E-11	6953	.044
<b>G63 AMG</b>													
2018-13	V8 5.5L		SILZKBR8D8S	97506									.028
<b>G65 AMG</b>													
2018-16	V12 6.0L	Dual Plug; 24 Req'd	<b>IFR6Q-G</b>	<b>5648</b>	FR6BHX-S	95159	BKR6EIX	6418	BKR6EGP	7092			.028
<b>G500</b>													
2008-03	V8 5.0L	Dual Plug; 16 Req'd	PFR5R-11	4292	FR5AHX	95839	BKR5EIX-11	5464	BKR5EGP	7090	BKR5E-11	6953	.039
2002	V8 5.0L	Dual Plug; 16 Req'd	<b>PFR5R-11</b>	<b>4292</b>	FR5AHX	95839	BKR5EIX-11	5464	BKR5EGP	7090	BKR5E	7938	.044
<b>G550</b>													
2015-09	V8 5.5L		<b>PLKR7A</b>	<b>4288</b>	LKR7BHX	94705	LKR7AIX	93911	LKR7BGP-8	95983			.032
<b>GL63 AMG</b>													
2016-13	V8 5.5L		SILZKBR8D8S	97506									.028
<b>GL320</b>													
2009-07	V6 3.0L	DIESEL	<b>CZ303</b>	<b>9970</b>									
<b>GL350</b>													
2016-14	V6 3.0L	DIESEL	<b>CZ551</b>	<b>92340</b>									
2013	V6 3.0L	DIESEL, From Engine 41324859	<b>CZ551</b>	<b>92340</b>									
		DIESEL, To Engine 41324858	<b>CZ159</b>	<b>92053</b>									
2012-10	V6 3.0L	DIESEL	<b>CZ303</b>	<b>9970</b>									
<b>GL450</b>													
2014-13	V8 4.6L		SILZKBR8D8S	97506									.028
2012-07	V8 4.6L		<b>PLKR7A</b>	<b>4288</b>	LKR7BHX	94705	LKR7AIX	93911	LKR7BGP-8	95983			.032
<b>GL550</b>													
2016-13	V8 4.6L		SILZKBR8D8S	97506									.028
2012-08	V8 5.5L		<b>PLKR7A</b>	<b>4288</b>	LKR7BHX	94705	LKR7AIX	93911	LKR7BGP-8	95983			.032
<b>GLA45 AMG</b>													
2018-15	L4 2.0L		<b>SILZKFR8D7S</b>	<b>95875</b>									.028
<b>GLA250</b>													
2018-15	L4 2.0L		<b>SILZKFR8E7S</b>	<b>90654</b>									.028
<b>GLC300</b>													
2018-16	L4 2.0L		<b>SILZKFR8E7S</b>	<b>90654</b>									.028
<b>GLC350e</b>													
2018	L4 2.0L		<b>SILZKFR8E7S</b>	<b>90654</b>									.028
<b>GLE63 AMG</b>													
2018-16	V8 5.5L		SILZKBR8D8S	97506									.028
<b>GLE63 AMG S</b>													
2018-16	V8 5.5L		SILZKBR8D8S	97506									.028
<b>GLE300d</b>													
2016	L4 2.1L	DIESEL	<b>CZ303</b>	<b>9970</b>									
<b>GLE350</b>													
2018-16	V6 3.5L	GAS	SILZKBR8D8S	97506									.028
<b>GLE550</b>													
2017-16	V8 4.6L		SILZKBR8D8S	97506									.028
<b>GLK250</b>													
2015-13	L4 2.1L	DIESEL	<b>CZ303</b>	<b>9970</b>									
<b>GLK350</b>													
2015-13	V6 3.5L		SILZKBR8D8S	97506									.028
2012-10	V6 3.5L		PLKR7A	4288	LKR7BHX	94705	LKR7AIX	93911	LKR7BGP-8	95983			.032
<b>GLS63 AMG</b>													
2018-17	V8 5.5L		SILZKBR8D8S	97506									.028
<b>GLS550</b>													
2018-17	V8 4.6L		SILZKBR8D8S	97506									.028
<b>Maybach S550</b>													
2017	V8 4.6L		SILZKBR8D8S	97506									.028
<b>Maybach S600</b>													
2017-16	V12 6.0L	Dual Plug; 24 Req'd	<b>IFR6Q-G</b>	<b>5648</b>	FR6BHX-S	95159	BKR6EIX	6418	BKR6EGP	7092			.028



Year	Cyl. L	Notes	Original Equipment		Ruthenium HX		Iridium IX		G-Power		V-Power		Gap
			Part	Stock	Part	Stock	Part	Stock	Part	Stock	Part	Stock	
<b>MERCEDES-BENZ (Cont'd)</b>													
Maybach S650													
2018	V12 6.0L	Dual Plug; 24 Req'd	<b>IFR6Q-G</b>	<b>5648</b>	FR6BHX-S	95159	BKR6EIX	6418	BKR6EGP	7092			.028
Metris													
2018-16	L4 2.0L		<b>SILZKFR8E7S</b>	<b>90654</b>									.028
ML55 AMG													
2003	V8 5.5L	Dual Plug; 16 Req'd	PFR5R-11	4292	FR5AHX	95839	BKR5EIX-11	5464	BKR5EGP	7090	BKR5E-11	6953	.044
2002-00	V8 5.5L	Dual Plug; 16 Req'd	<b>PFR5R-11</b>	<b>4292</b>	FR5AHX	95839	BKR5EIX-11	5464	BKR5EGP	7090	BKR5E	7938	.044
ML63 AMG													
2015-12	V8 5.5L		SILZKBR8D8S	97506									.028
2011-07	V8 6.3L		<b>ILZKAR7A10</b>	<b>6043</b>									.039
ML250													
2015	L4 2.1L	DIESEL	<b>CZ303</b>	<b>9970</b>									
ML320													
2009-07	V6 3.0L	DIESEL	<b>CZ303</b>	<b>9970</b>									
2003	V6 3.2L	Dual Plug; 12 Req'd	PFR5R-11	4292	FR5AHX	95839	BKR5EIX-11	5464	BKR5EGP	7090	BKR5E-11	6953	.044
2002	V6 3.2L	Dual Plug; 12 Req'd	PFR5R-11	4292	FR5AHX	95839	BKR5EIX-11	5464	BKR5EGP	7090	BKR5E	7938	.044
2001-98	V6 3.2L	Dual Plug; 12 Req'd	<b>PFR5R-11</b>	<b>4292</b>	FR5AHX	95839	BKR5EIX-11	5464	BKR5EGP	7090	BKR5E	7938	.044
ML350													
2015-14	V6 3.0L	DIESEL	<b>CZ551</b>	<b>92340</b>									
	V6 3.5L	GAS	SILZKBR8D8S	97506									.028
2013	V6 3.0L	DIESEL, From Engine 41324859	<b>CZ551</b>	<b>92340</b>									
		DIESEL, To Engine 41324858	<b>CZ159</b>	<b>92053</b>									
	V6 3.5L	GAS	SILZKBR8D8S	97506									.028
2012	V6 3.0L	DIESEL	<b>CZ159</b>	<b>92053</b>									
	V6 3.5L	GAS	SILZKBR8D8S	97506									.028
2011-10	V6 3.0L	DIESEL	<b>CZ303</b>	<b>9970</b>									
	V6 3.5L		PLKR7A	4288	LKR7BHX	94705	LKR7AIX	93911	LKR7BGP-8	95983			.032
2009-06	V6 3.5L		PLKR7A	4288	LKR7BHX	94705	LKR7AIX	93911	LKR7BGP-8	95983			.032
2005-03	V6 3.7L	Dual Plug; 12 Req'd	<b>PFR5R-11</b>	<b>4292</b>	FR5AHX	95839	BKR5EIX-11	5464	BKR5EGP	7090	BKR5E-11	6953	.040
ML430													
2001-99	V8 4.3L	Dual Plug; 16 Req'd	<b>PFR5R-11</b>	<b>4292</b>	FR5AHX	95839	BKR5EIX-11	5464	BKR5EGP	7090	BKR5E	7938	.044
ML450													
2011-10	V6 3.5L		PLKR7A	4288	LKR7BHX	94705	LKR7AIX	93911	LKR7BGP-8	95983			.032
ML500													
2007	V8 5.0L	Dual Plug; 16 Req'd	PFR5R-11	4292	FR5AHX	95839	BKR5EIX-11	5464	BKR5EGP	7090	BKR5E-11	6953	.039
2006-05	V8 5.0L		<b>PLKR7A</b>	<b>4288</b>	LKR7BHX	94705	LKR7AIX	93911	LKR7BGP-8	95983			.032
2004-03	V8 5.0L	Dual Plug; 16 Req'd	PFR5R-11	4292	FR5AHX	95839	BKR5EIX-11	5464	BKR5EGP	7090	BKR5E-11	6953	.039
2002	V8 5.0L	Dual Plug; 16 Req'd	<b>PFR5R-11</b>	<b>4292</b>	FR5AHX	95839	BKR5EIX-11	5464	BKR5EGP	7090	BKR5E	7938	.044
ML550													
2015-12	V8 4.6L		SILZKBR8D8S	97506									.028
2011-08	V8 5.5L		<b>PLKR7A</b>	<b>4288</b>	LKR7BHX	94705	LKR7AIX	93911	LKR7BGP-8	95983			.032
R63 AMG													
2007	V8 6.3L		<b>ILZKAR7A10</b>	<b>6043</b>									.040
R320													
2009-07	V6 3.0L	DIESEL	<b>CZ303</b>	<b>9970</b>									
R350													
2013-12	V6 3.0L	DIESEL	<b>CZ303</b>	<b>9970</b>									
	V6 3.5L		SILZKBR8D8S	97506									.028
2011-10	V6 3.0L	DIESEL	<b>CZ303</b>	<b>9970</b>									
	V6 3.5L		PLKR7A	4288	LKR7BHX	94705	LKR7AIX	93911	LKR7BGP-8	95983			.032
2009-06	V6 3.5L		PLKR7A	4288	LKR7BHX	94705	LKR7AIX	93911	LKR7BGP-8	95983			.032
R500													
2007-06	V8 5.0L	Dual Plug; 16 Req'd	PFR5R-11	4292	FR5AHX	95839	BKR5EIX-11	5464	BKR5EGP	7090	BKR5E-11	6953	.044
S55 AMG													
2006-03	V8 5.5L	Dual Plug; 16 Req'd	<b>ILFR6A</b>	<b>3588</b>	LF6R6BHX	93420	LF6R6AIX	93893	LF6R6CGP	1483			.032
2002-01	V8 5.5L	Dual Plug; 16 Req'd	<b>PFR5R-11</b>	<b>4292</b>	FR5AHX	95839	BKR5EIX-11	5464	BKR5EGP	7090	BKR5E	7938	.044

**Bold denotes NGK OE Manufacturer and/or OE Service Part**  
NOT BOLD denotes OE Equivalent Part

**Le texte en gras désigne une pièce d'équipement originale du manufacturier NGK et/ou pièce d'équipement originale de service**  
Le texte non en gras désigne une pièce d'équipement originale équivalente

Note: Due to different operating or engine conditions, alternate heat range plugs may be required.

Note: En raison de différences au niveau du fonctionnement ou des conditions du moteur, d'autres types de bougies avec variation de chaleur peuvent être nécessaires





Year	Cyl. L	Notes	Original Equipment		Ruthenium HX		Iridium IX		G-Power		V-Power		Gap
			Part	Stock	Part	Stock	Part	Stock	Part	Stock	Part	Stock	
<b>MERCEDES-BENZ (Cont'd)</b>													
<b>S63 AMG</b>													
2017-11	V8 5.5L		SILZKBR8D8S	97506									.028
2010-08	V8 6.3L		<b>ILZKAR7A10</b>	<b>6043</b>									.040
<b>S65 AMG</b>													
2018-15	V12 6.0L	Dual Plug; 24 Req'd	<b>IFR6Q-G</b>	<b>5648</b>	FR6BHX-S	95159	BKR6EIX	6418	BKR6EGP	7092			.028
2013-06	V12 6.0L	Dual Plug; 24 Req'd	<b>IFR6Q-G</b>	<b>5648</b>	FR6BHX-S	95159	BKR6EIX	6418	BKR6EGP	7092			.028
<b>S320</b>													
1999-98	L6 3.2L		BKR5ES	2460	FR5BHX	96457	BKR5EIX	6341	BKR5EGP	7090	BKR5E	7938	.032
1997	L6 3.2L		BKR5E	7938	FR5BHX	96457	BKR5EIX	6341	BKR5EGP	7090	BKR5E	7938	.032
1996-94	L6 3.2L		BKR5E	7938			BKR5EIX	6341	BKR5EGP	7090	BKR5E	7938	.032
<b>S350</b>													
2013	V6 3.0L	DIESEL, From Engine 41324859	<b>CZ551</b>	<b>92340</b>									
		DIESEL, To Engine 41324858	<b>CZ159</b>	<b>92053</b>									
2012	V6 3.0L	DIESEL	<b>CZ159</b>	<b>92053</b>									
2006	V6 3.7L		PLKR7A	4288	LKR7BHX	94705	LKR7AIX	93911	LKR7BGP-8	95983			.032
1995-94	L6 3.4L	DIESEL	Y-918J	3704									
<b>S400</b>													
2013-10	V6 3.5L		PLKR7A	4288	LKR7BHX	94705	LKR7AIX	93911	LKR7BGP-8	95983			.032
<b>S420</b>													
1999-98	V8 4.2L		PFR5R-11	4292	FR5AHX	95839	BKR5EIX-11	5464	BKR5EGP	7090	BKR5E	7938	.039
1997	V8 4.2L		BKR5E	7938	FR5AHX	95839	BKR5EIX	6341	BKR5EGP	7090	BKR5E	7938	.032
1996-94	V8 4.2L		BKR5E	7938			BKR5EIX	6341	BKR5EGP	7090	BKR5E	7938	.032
<b>S430</b>													
2006-03	V8 4.3L	Dual Plug; 16 Req'd	PFR5R-11	4292	FR5AHX	95839	BKR5EIX-11	5464	BKR5EGP	7090	BKR5E-11	6953	.044
2002-00	V8 4.3L	Dual Plug; 16 Req'd	<b>PFR5R-11</b>	<b>4292</b>	FR5AHX	95839	BKR5EIX-11	5464	BKR5EGP	7090	BKR5E	7938	.044
<b>S450</b>													
2011-08	V8 4.6L		<b>PLKR7A</b>	<b>4288</b>	LKR7BHX	94705	LKR7AIX	93911	LKR7BGP-8	95983			.032
<b>S500</b>													
2006-01	V8 5.0L	Dual Plug; 16 Req'd	PFR5R-11	4292	FR5AHX	95839	BKR5EIX-11	5464	BKR5EGP	7090	BKR5E-11	6953	.039
2000	V8 5.0L	Dual Plug; 16 Req'd	PFR5R-11	4292	FR5AHX	95839	BKR5EIX-11	5464	BKR5EGP	7090	BKR5E-11	6953	.044
1999-98	V8 5.0L		PFR5R-11	4292	FR5AHX	95839	BKR5EIX-11	5464	BKR5EGP	7090	BKR5E	7938	.039
1997	V8 5.0L		BKR5E	7938	FR5AHX	95839	BKR5EIX	6341	BKR5EGP	7090	BKR5E	7938	.032
1996-94	V8 5.0L		BKR5E	7938			BKR5EIX	6341	BKR5EGP	7090	BKR5E	7938	.032
<b>S550</b>													
2017-12	V8 4.6L		SILZKBR8D8S	97506									.028
2011-07	V8 5.5L		<b>PLKR7A</b>	<b>4288</b>	LKR7BHX	94705	LKR7AIX	93911	LKR7BGP-8	95983			.032
<b>S600</b>													
2017-15	V12 6.0L	Dual Plug; 24 Req'd	<b>IFR6Q-G</b>	<b>5648</b>	FR6BHX-S	95159	BKR6EIX	6418	BKR6EGP	7092			.028
2013-03	V12 5.5L	Dual Plug; 24 Req'd	<b>IFR6Q-G</b>	<b>5648</b>	FR6BHX-S	95159	BKR6EIX	6418	BKR6EGP	7092			.028
2002	V12 5.8L	Dual Plug; 24 Req'd	PFR6T-10G	5542	FR6AHX-S	94279	BKR6EIX-11	3764	BKR6EGP	7092	BKR6E-11	2756	.040
2001	V12 5.8L	Dual Plug; 24 Req'd	<b>PFR5R-11</b>	<b>4292</b>	FR5AHX	95839	BKR5EIX-11	5464	BKR5EGP	7090	BKR5E	7938	.044
1999-98	V12 6.0L		PFR5R-11	4292	FR5AHX	95839	BKR5EIX-11	5464	BKR5EGP	7090	BKR5E	7938	.039
1997	V12 6.0L		BKR5E	7938	FR5AHX	95839	BKR5EIX	6341	BKR5EGP	7090	BKR5E	7938	.032
1996-94	V12 6.0L		BKR5E	7938			BKR5EIX	6341	BKR5EGP	7090	BKR5E	7938	.032
<b>SL55 AMG</b>													
2008-03	V8 5.5L	Dual Plug; 16 Req'd	<b>ILFR6A</b>	<b>3588</b>	LF6BHX	93420	LF6AIX	93893	LF6CGP	1483			.032
<b>SL63 AMG</b>													
2018-13	V8 5.5L		SILZKBR8D8S	97506									.028
2012-09	V8 6.3L		<b>ILZKAR7A10</b>	<b>6043</b>									.039
<b>SL65 AMG</b>													
2018-13	V12 6.0L	Dual Plug; 24 Req'd	<b>IFR6Q-G</b>	<b>5648</b>	FR6BHX-S	95159	BKR6EIX	6418	BKR6EGP	7092			.028
2011-05	V12 6.0L	Dual Plug; 24 Req'd	<b>IFR6Q-G</b>	<b>5648</b>	FR6BHX-S	95159	BKR6EIX	6418	BKR6EGP	7092			.028
<b>SL320</b>													
1997	L6 3.2L		BKR5E	7938	FR5BHX	96457	BKR5EIX	6341	BKR5EGP	7090	BKR5E	7938	.032
1996-94	L6 3.2L		BKR5E	7938			BKR5EIX	6341	BKR5EGP	7090	BKR5E	7938	.032
<b>SL500</b>													
2006-03	V8 5.0L	Dual Plug; 16 Req'd	PFR5R-11	4292	FR5AHX	95839	BKR5EIX-11	5464	BKR5EGP	7090	BKR5E-11	6953	.039



Year	Cyl. L	Notes	Original Equipment		Ruthenium HX		Iridium IX		G-Power		V-Power		Gap
			Part	Stock	Part	Stock	Part	Stock	Part	Stock	Part	Stock	
<b>MERCEDES-BENZ (Cont'd)</b>													
<b>SL500 (Cont'd)</b>													
2002-01	V8 5.0L	Dual Plug; 16 Req'd	<b>PFR5R-11</b>	<b>4292</b>	FR5AHX	95839	BKR5EIX-11	5464	BKR5EGP	7090	BKR5E	7938	.044
2000-99	V8 5.0L	Dual Plug; 16 Req'd	PFR5R-11	4292	FR5AHX	95839	BKR5EIX-11	5464	BKR5EGP	7090	BKR5E-11	6953	.040
1998	V8 5.0L		PFR5R-11	4292	FR5AHX	95839	BKR5EIX-11	5464	BKR5EGP	7090	BKR5E	7938	.039
1997	V8 5.0L		BKR5E	7938	FR5AHX	95839	BKR5EIX	6341	BKR5EGP	7090	BKR5E	7938	.032
1996-94	V8 5.0L		BKR5E	7938			BKR5EIX	6341	BKR5EGP	7090	BKR5E	7938	.032
<b>SL550</b>													
2018-13	V8 4.6L		SILZKBR8D8S	97506									.028
2012-07	V8 5.5L		<b>PLKR7A</b>	<b>4288</b>	LKR7BHX	94705	LKR7AIX	93911	LKR7BGP-8	95983			.032
<b>SL600</b>													
2011-04	V12 5.5L	Dual Plug; 24 Req'd	<b>IFR6Q-G</b>	<b>5648</b>	FR6BHX-S	95159	BKR6EIX	6418	BKR6EGP	7092			.028
2002-98	V12 6.0L		PFR5R-11	4292	FR5AHX	95839	BKR5EIX-11	5464	BKR5EGP	7090	BKR5E	7938	.039
1997	V12 6.0L		BKR5E	7938	FR5AHX	95839	BKR5EIX	6341	BKR5EGP	7090	BKR5E	7938	.032
1996-94	V12 6.0L		BKR5E	7938			BKR5EIX	6341	BKR5EGP	7090	BKR5E	7938	.032
<b>SLC300</b>													
2018-17	L4 2.0L		<b>SILZKFR8E7S</b>	<b>90654</b>									.028
<b>SLK32 AMG</b>													
2004-02	V6 3.2L	Supercharged, Dual Plug; 12 Req'd	<b>IFR6D10</b>	<b>5344</b>	FR6BHX-S	95159	BKR6EIX-11	3764	BKR6EGP	7092	BKR6E-11	2756	.040
<b>SLK55 AMG</b>													
2016-12	V8 5.5L		SILZKBR8D8S	97506									.028
2011-05	V8 5.5L	Dual Plug; 16 Req'd	<b>IFR6D10</b>	<b>5344</b>	FR6AHX-S	94279	BKR6EIX-11	3764	BKR6EGP	7092	BKR6E-11	2756	.040
<b>SLK230</b>													
2004-03	L4 2.3L		<b>IFR6D10</b>	<b>5344</b>	FR6BHX-S	95159	BKR6EIX-11	3764	BKR6EGP	7092	BKR6E-11	2756	.040
2002-01	L4 2.3L		<b>IFR6D10</b>	<b>5344</b>	FR6BHX-S	95159	BKR6EIX	6418	BKR6EGP	7092	BKR6E-11	2756	.040
2000-98	L4 2.3L		BCPR5ES-11	6696	FR5BHX	96457	BCPR5EIX-11	3306	FR5GP	3248	FR5	7373	.039
<b>SLK250</b>													
2015-14	L4 1.8L		<b>PLKR7B8E</b>	<b>94716</b>	LKR7BHX	94705							.032
2013-12	L4 1.8L		<b>PLKR7B8E</b>	<b>94716</b>	LKR7BHX	94705	LKR7AIX	93911					.032
<b>SLK280</b>													
2008-06	V6 3.0L		PLKR7A	4288	LKR7BHX	94705	LKR7AIX	93911	LKR7BGP-8	95983			.032
<b>SLK300</b>													
2016	L4 2.0L		<b>SILZKFR8E7S</b>	<b>90654</b>									.028
2011-09	V6 3.0L		PLKR7A	4288	LKR7BHX	94705	LKR7AIX	93911	LKR7BGP-8	95983			.032
<b>SLK320</b>													
2004-01	V6 3.2L	Naturally Aspirated, Dual Plug; 12 Req'd	<b>PFR5R-11</b>	<b>4292</b>	FR5AHX	95839	BKR5EIX-11	5464	BKR5EGP	7090	BKR5E-11	6953	.044
<b>SLK350</b>													
2016-12	V6 3.5L		SILZKBR8D8S	97506									.028
2011-05	V6 3.5L		PLKR7A	4288	LKR7BHX	94705	LKR7AIX	93911	LKR7BGP-8	95983			.032
<b>SLR McLaren</b>													
2009-05	V8 5.5L	Dual Plug; 16 Req'd	<b>ILFR6A</b>	<b>3588</b>	LF6BHX	93420	LF6AIX	93893	LF6CGP	1483			.032
<b>Sprinter 2500</b>													
2015-14	L4 2.1L	DIESEL	<b>CZ303</b>	<b>9970</b>									
	V6 3.0L	DIESEL	<b>CZ303</b>	<b>9970</b>									
2013	V6 3.0L	DIESEL	<b>CZ303</b>	<b>9970</b>									
<b>Sprinter 3500</b>													
2015-14	L4 2.1L	DIESEL	<b>CZ303</b>	<b>9970</b>									
	V6 3.0L	DIESEL	<b>CZ303</b>	<b>9970</b>									
2013	V6 3.0L	DIESEL	<b>CZ303</b>	<b>9970</b>									
<b>MERCURY</b>													
<b>Capri</b>													
1994-91	L4 1.6L		BKR6E-11	2756			BKR6EIX-11	3764	BKR6EGP	7092	BKR6E-11	2756	.044
1986	L4 2.3L		TR5-1	7060			TR5-1IX	7243	TR5-1GP	3716	TR5-1	7060	.044
	V6 3.8L		TR55-1	2683			TR55-1IX	7316	TR55-1GP	7159	TR55-1	2683	.054
	V8 5.0L		TR55-1	2683			TR55-1IX	7316	TR55-1GP	7159	TR55-1	2683	.050
1985	L4 2.3L		TR5-1	7060			TR5-1IX	7243	TR5-1GP	3716	TR5-1	7060	.044
	V6 3.8L		TR55-1	2683			TR55-1IX	7316	TR55-1GP	7159	TR55-1	2683	.054

**Bold denotes NGK OE Manufacturer and/or OE Service Part**  
NOT BOLD denotes OE Equivalent Part

**Le texte en gras désigne une pièce d'équipement originale du manufacturier NGK et/ou pièce d'équipement originale de service**  
Le texte non en gras désigne une pièce d'équipement originale équivalente

Note: Due to different operating or engine conditions, alternate heat range plugs may be required.

Note: En raison de différences au niveau du fonctionnement ou des conditions du moteur, d'autres types de bougies avec variation de chaleur peuvent être nécessaires



Year	Cyl. L	Notes	Original Equipment		Ruthenium HX		Iridium IX		G-Power		V-Power		Gap
			Part	Stock	Part	Stock	Part	Stock	Part	Stock	Part	Stock	
<b>MERCURY (Cont'd)</b>													
Capri (Cont'd)													
1985	V8 5.0L		UR4	6630			UR4IX	7401	UR4GP	2869	UR4	6630	.044
Colony Park													
1991-87	V8 5.0L		TR55-1	2683			TR55-1IX	7316	TR55-1GP	7159	TR55-1	2683	.050
Cougar													
2002-99	L4 2.0L		PTR5A-13	2467			LTR5IX-11	4344	LTR5GP	5019			.050
	V6 2.5L		PTR5C-13	7740			TR55IX	7164	TR55GP	3403	TR55	3951	.054
1997-95	V6 3.8L		TR55-1	2683			TR55-1IX	7316	TR55-1GP	7159	TR55-1	2683	.054
	V8 4.6L		PTR5C-13	7740			TR55IX	7164	TR55GP	3403	TR55	3951	.054
1994	V6 3.8L		TR55-1	2683			TR55-1IX	7316	TR55-1GP	7159	TR55-1	2683	.054
	V8 4.6L		TR55	3951			TR55IX	7164	TR55GP	3403	TR55	3951	.054
1993-91	V6 3.8L		TR55-1	2683			TR55-1IX	7316	TR55-1GP	7159	TR55-1	2683	.054
	V8 5.0L		UR45	6945			UR45IX	7559	UR45GP	3207	UR45	6945	.054
1990-89	V6 3.8L		TR55-1	2683			TR55-1IX	7316	TR55-1GP	7159	TR55-1	2683	.054
1988-87	V6 3.8L		TR55-1	2683			TR55-1IX	7316	TR55-1GP	7159	TR55-1	2683	.054
	V8 5.0L		TR55-1	2683			TR55-1IX	7316	TR55-1GP	7159	TR55-1	2683	.050
1986	L4 2.3L		TR5	2238			TR5IX	7397	TR5GP	3186	TR5	2238	.044
	V6 3.8L		TR55-1	2683			TR55-1IX	7316	TR55-1GP	7159	TR55-1	2683	.054
	V8 5.0L		TR55-1	2683			TR55-1IX	7316	TR55-1GP	7159	TR55-1	2683	.050
1985	L4 2.3L		TR5	2238			TR5IX	7397	TR5GP	3186	TR5	2238	.044
	V6 3.8L		TR55-1	2683			TR55-1IX	7316	TR55-1GP	7159	TR55-1	2683	.054
	V8 5.0L		UR45	6945			UR45IX	7559	UR45GP	3207	UR45	6945	.050
Grand Marquis													
2011	V8 4.6L	FLEX, FFV and/or CNG Fuel Conversions	PTR6D-13	5598	TR6AHX	92714	TR6IX	3689	TR6GP	5141	TR6	4177	.044
2010-09	V8 4.6L	FLEX, FFV and/or CNG Fuel Conversions	PTR6D-13	5598	TR6AHX	92714	TR6IX	3689	TR6GP	5141	TR6	4177	.044
			GAS	TR55	3951	TR5AHX	94567	TR55IX	7164	TR55GP	3403	TR55	3951
2008-06	V8 4.6L	FLEX, FFV and/or CNG Fuel Conversions	PTR6D-13	5598	TR6AHX	92714	TR6IX	3689	TR6GP	5141	TR6	4177	.044
			GAS	PTR5C-13	7740	TR5AHX	94567	TR55IX	7164	TR55GP	3403	TR55	3951
2005-98	V8 4.6L	GAS	PTR5C-13	7740	TR5AHX	94567	TR55IX	7164	TR55GP	3403	TR55	3951	.054
1997-96	V8 4.6L	GAS	PTR5C-13	7740			TR55IX	7164	TR55GP	3403	TR55	3951	.054
1995	V8 4.6L		PTR5C-13	7740			TR55IX	7164	TR55GP	3403	TR55	3951	.054
1994-92	V8 4.6L		TR55	3951			TR55IX	7164	TR55GP	3403	TR55	3951	.054
1991-90	V8 5.0L		TR55-1	2683			TR55-1IX	7316	TR55-1GP	7159	TR55-1	2683	.050
1989-86	V8 5.0L		TR55-1	2683			TR55-1IX	7316	TR55-1GP	7159	TR55-1	2683	.050
	V8 5.8L		UR4	6630			UR4IX	7401	UR4GP	2869	UR4	6630	.044
1985	V8 5.0L		UR45	6945			UR45IX	7559	UR45GP	3207	UR45	6945	.050
	V8 5.8L		UR4	6630			UR4IX	7401	UR4GP	2869	UR4	6630	.044
Lynx													
1987-86	L4 1.9L		TR5-1	7060			TR5-1IX	7243	TR5-1GP	3716	TR5-1	7060	.044
1985	L4 1.6L		TR5	2238			TR5IX	7397	TR5GP	3186	TR5	2238	.044
	L4 1.9L		TR5-1	7060			TR5-1IX	7243	TR5-1GP	3716	TR5-1	7060	.044
Marauder													
2004	V8 4.6L		PZTR5A-15	7862	TR5AHX	94567	TR55IX	7164	TR55GP	3403	TR55	3951	.060
2003	V8 4.6L		PTR5C-13	7740	TR5AHX	94567	TR55IX	7164	TR55GP	3403	TR55	3951	.052
Mariner													
2011-09	L4 2.5L		<b>ILTR5K13</b>	<b>90607</b>	LTR5AHX	90220	LTR5IX-11	4344	LTR5GP	5019			.052
	V6 3.0L		<b>TR5C-12</b>	<b>92838</b>	TR5AHX	94567	TR5IX	7397	TR5GP	3186	TR5	2238	.048
2008-05	L4 2.3L		<b>ITR5H13</b>	<b>97287</b>	TR5AHX	94567	TR55IX	7164	TR55GP	3403	TR55	3951	.052
	V6 3.0L		PTR5C-13	7740	TR5AHX	94567	TR55IX	7164	TR55GP	3403	TR55	3951	.054
Marquis													
1986-85	L4 2.3L		TR5-1	7060			TR5-1IX	7243	TR5-1GP	3716	TR5-1	7060	.044
	V6 3.8L		TR55-1	2683			TR55-1IX	7316	TR55-1GP	7159	TR55-1	2683	.054
Milan													
2011	L4 2.5L		<b>ILTR5K13</b>	<b>90607</b>	LTR5AHX	90220	LTR5IX-11	4344	LTR5GP	5019			.052



Year	Cyl. L	Notes	Original Equipment		Ruthenium HX		Iridium IX		G-Power		V-Power		Gap
			Part	Stock	Part	Stock	Part	Stock	Part	Stock	Part	Stock	
<b>MERCURY (Cont'd)</b>													
<b>Milan (Cont'd)</b>													
2011	V6 3.0L		<b>TR5C-12</b>	<b>92838</b>	TR5AHX	94567	TR5IX	7397	TR5GP	3186	TR5	2238	.048
2010	L4 2.5L		<b>ILTR5K13</b>	<b>90607</b>	LTR5AHX	90220	LTR5IX-11	4344	LTR5GP	5019			.052
	V6 3.0L	From 8/3/2009 To 8/3/2009	<b>TR5C-12</b>	<b>92838</b>	TR5AHX	94567	TR5IX	7397	TR5GP	3186	TR5	2238	.048
2009-06	L4 2.3L		<b>ILTR5K13</b>	<b>90607</b>	LTR5AHX	90220	LTR5IX-11	4344	LTR5GP	5019			.052
	V6 3.0L		PTR5C-13	7740	TR5AHX	94567	TR55IX	7164	TR55GP	3403	TR55	3951	.054
<b>Montego</b>													
2007-05	V6 3.0L		PTR5C-13	7740	TR5AHX	94567	TR55IX	7164	TR55GP	3403	TR55	3951	.054
<b>Monterey</b>													
2007-06	V6 4.2L		TR55-1	2683			TR55-1IX	7316	TR55-1GP	7159	TR55-1	2683	.054
2005-04	V6 4.2L		PTR5C-13	7740			TR55IX	7164	TR55GP	3403	TR55	3951	.054
<b>Mountaineer</b>													
2010-09	V6 4.0L		TR55-1	2683			TR55-1IX	7316	TR55-1GP	7159	TR55-1	2683	.054
	V8 4.6L		<b>PZNAR6A11H</b>	<b>5507</b>			ZNAR6AIX-11	372	ZNAR6AGP	1698			.044
2008	V6 4.0L		TR55-1	2683			TR55-1IX	7316	TR55-1GP	7159	TR55-1	2683	.054
	V8 4.6L	New engine style with brown coil boots only (NGK N/A for old engine design with black coil boots)	<b>PZNAR6A11H</b>	<b>5507</b>			ZNAR6AIX-11	372	ZNAR6AGP	1698			.044
2007-06	V6 4.0L		TR55-1	2683			TR55-1IX	7316	TR55-1GP	7159	TR55-1	2683	.054
2005-02	V6 4.0L		PTR5C-13	7740			TR55IX	7164	TR55GP	3403	TR55	3951	.054
	V8 4.6L		PTR5C-13	7740	TR5AHX	94567	TR55IX	7164	TR55GP	3403	TR55	3951	.054
2001-98	V6 4.0L		PTR5C-13	7740			TR55IX	7164	TR55GP	3403	TR55	3951	.054
	V8 5.0L		PTR5C-13	7740			TR55IX	7164	TR55GP	3403	TR55	3951	.054
1997	V8 5.0L		PTR5C-13	7740			TR55IX	7164	TR55GP	3403	TR55	3951	.054
<b>Mystique</b>													
2000-95	L4 2.0L		PTR5A-13	2467			LTR5IX-11	4344	LTR5GP	5019			.050
	V6 2.5L		PTR5C-13	7740			TR55IX	7164	TR55GP	3403	TR55	3951	.054
<b>Sable</b>													
2009-08	V6 3.5L		<b>ILTR5K13</b>	<b>90607</b>	LTR5AHX	90220	LTR5IX-11	4344	LTR5GP	5019			.052
2005-03	V6 3.0L	DOHC	PTR5C-13	7740	TR5AHX	94567	TR55IX	7164	TR55GP	3403	TR55	3951	.054
		FLEX, OHV	PTR6D-13	5598			TR6IX	3689	TR6GP	5141	TR6	4177	.044
		GAS, OHV	PTR5F-11	6579			TR5IX	7397	TR5GP	3186	TR5	2238	.044
2002	V6 3.0L	DOHC	PTR5C-13	7740	TR5AHX	94567	TR55IX	7164	TR55GP	3403	TR55	3951	.054
		GAS, OHV	PTR5F-11	6579			TR5IX	7397	TR5GP	3186	TR5	2238	.044
2001	V6 3.0L	DOHC	PTR5C-13	7740	TR5AHX	94567	TR55IX	7164	TR55GP	3403	TR55	3951	.054
		FLEX, OHV	PTR6D-13	5598			TR6IX	3689	TR6GP	5141	TR6	4177	.044
		GAS, OHV	PTR5F-11	6579			TR5IX	7397	TR5GP	3186	TR5	2238	.044
2000	V6 3.0L	DOHC	PTR5C-13	7740	TR5AHX	94567	TR55IX	7164	TR55GP	3403	TR55	3951	.054
		GAS, OHV	PTR5F-11	6579			TR5IX	7397	TR5GP	3186	TR5	2238	.044
1999	V6 3.0L	DOHC	PTR5C-13	7740			TR55IX	7164	TR55GP	3403	TR55	3951	.054
		GAS, OHV	PTR5F-11	6579			TR5IX	7397	TR5GP	3186	TR5	2238	.044
1998-96	V6 3.0L	DOHC	PTR5C-13	7740			TR55IX	7164	TR55GP	3403	TR55	3951	.054
		OHV	PTR5F-11	6579			TR5IX	7397	TR5GP	3186	TR5	2238	.044
1995-88	V6 3.0L		TR5	2238			TR5IX	7397	TR5GP	3186	TR5	2238	.044
	V6 3.8L		TR55-1	2683			TR55-1IX	7316	TR55-1GP	7159	TR55-1	2683	.054
1987	V6 3.0L		TR5	2238			TR5IX	7397	TR5GP	3186	TR5	2238	.044
1986	L4 2.5L		TR5	2238			TR5IX	7397	TR5GP	3186	TR5	2238	.044
	V6 3.0L		TR5	2238			TR5IX	7397	TR5GP	3186	TR5	2238	.044
<b>Topaz</b>													
1994-92	L4 2.3L		TR55	3951			TR55IX	7164	TR55GP	3403	TR55	3951	.054
	V6 3.0L		TR5	2238			TR5IX	7397	TR5GP	3186	TR5	2238	.044
1991-89	L4 2.3L		TR55	3951			TR55IX	7164	TR55GP	3403	TR55	3951	.054
1988-87	L4 2.3L		TR5	2238			TR5IX	7397	TR5GP	3186	TR5	2238	.044
1986-85	L4 2.0L	DIESEL	Y-107R	1229									
	L4 2.3L		TR5	2238			TR5IX	7397	TR5GP	3186	TR5	2238	.044

**Bold denotes NGK OE Manufacturer and/or OE Service Part**  
NOT BOLD denotes OE Equivalent Part

**Le texte en gras désigne une pièce d'équipement originale du manufacturier NGK et/ou pièce d'équipement originale de service**  
Le texte non en gras désigne une pièce d'équipement originale équivalente

Note: Due to different operating or engine conditions, alternate heat range plugs may be required.

Note: En raison de différences au niveau du fonctionnement ou des conditions du moteur, d'autres types de bougies avec variation de chaleur peuvent être nécessaires



Year	Cyl. L	Notes	Original Equipment		Ruthenium HX		Iridium IX		G-Power		V-Power		Gap
			Part	Stock	Part	Stock	Part	Stock	Part	Stock	Part	Stock	
<b>MERCURY (Cont'd)</b>													
<b>Tracer</b>													
1999-97	L4 2.0L		TR55-1	2683			TR55-1IX	7316	TR55-1GP	7159	TR55-1	2683	.054
1996-91	L4 1.8L		BKR6E-11	2756			BKR6EIX-11	3764	BKR6EGP	7092	BKR6E-11	2756	.044
	L4 1.9L		TR55-1	2683			TR55-1IX	7316	TR55-1GP	7159	TR55-1	2683	.054
1990-88	L4 1.6L		GR4	2635			GR4IX	97382	GR4GP	2763	GR4	2635	.044
1987	L4 1.6L		GR4	2635			GR4IX	97382	GR4GP	2763	GR4	2635	.034
<b>Villager</b>													
2002-99	V6 3.3L		<b>PFR5G-11</b>	<b>2647</b>	FR5AHX	95839	BKR5EIX-11	5464	BKR5EGP	7090	BKR5E-11	6953	.044
1998-97	V6 3.0L		<b>BKR5EY</b>	<b>7390</b>	FR5AHX	95839	BKR5EIX	6341	BKR5EGP	7090	BKR5EY	7390	.034
1996-93	V6 3.0L		<b>BKR5EY</b>	<b>7390</b>			BKR5EIX	6341	BKR5EGP	7090	BKR5EY	7390	.034
<b>MERKUR</b>													
<b>Scorpio</b>													
1989-88	V6 2.9L		TR5	2238			TR5IX	7397	TR5GP	3186	TR5	2238	.044
<b>XR4Ti</b>													
1989-85	L4 2.3L		TR5	2238			TR5IX	7397	TR5GP	3186	TR5	2238	.034
<b>MINI</b>													
<b>Cooper</b>													
2017-16	L3 1.5L		<b>SILZKGR8B8S</b>	<b>94201</b>									.030
	L4 2.0L		<b>SILZKGR8B8S</b>	<b>94201</b>									.030
2015-14	L3 1.5L		<b>SILZKGR8B8S</b>	<b>94201</b>									.030
	L4 1.6L	Naturally Aspirated	PLZKBR7B8DG	90223									.032
		Turbo	PLZKBR7B8DG	90223									.026
L4 2.0L		<b>SILZKGR8B8S</b>	<b>94201</b>									.030	
2013	L4 1.6L	Naturally Aspirated	PLZKBR7B8DG	90223									.032
		Turbo	PLZKBR7B8DG	90223									.026
2012-11	L4 1.6L	Naturally Aspirated, Eng Desg N16B16A	PLZKBR7B8DG	90223									.032
		Turbo, Eng Desg N14B16C	<b>ILZKBR7B8DG</b>	<b>95770</b>									.032
		Turbo, Eng Desg N18B16A	PLZKBR7B8DG	90223									.026
2010-09	L4 1.6L	Naturally Aspirated	PLZKBR7B8DG	90223									.032
		Turbo	<b>ILZKBR7B8DG</b>	<b>95770</b>									.032
2008-07	L4 1.6L	DOHC, Eng Desg N12B16A	PLZKBR7B8DG	90223									.032
		DOHC, Eng Desg N14B16A	<b>ILZKBR7B8DG</b>	<b>95770</b>									.032
		SOHC, Eng Desg W10B16A	<b>BKR6EQUP</b>	<b>3199</b>	FR6BHX-S	95159	BKR6EIX-11	3764	BKR6EGP	7092	BKR6E-11	2756	.045
		SOHC, Eng Desg W11B16A	<b>BKR6EQUP</b>	<b>3199</b>	FR6BHX-S	95159	BKR6EIX-11	3764	BKR6EGP	7092	BKR6E-11	2756	.045
2006-02	L4 1.6L		<b>BKR6EQUP</b>	<b>3199</b>	FR6BHX-S	95159	BKR6EIX	6418	BKR6EGP	7092	BKR6E	6962	.032
<b>Cooper Clubman</b>													
2017-16	L3 1.5L		<b>SILZKGR8B8S</b>	<b>94201</b>									.030
	L4 2.0L		<b>SILZKGR8B8S</b>	<b>94201</b>									.030
<b>Cooper Countryman</b>													
2017	L3 1.5L		<b>SILZKGR8B8S</b>	<b>94201</b>									.030
	L4 2.0L		<b>SILZKGR8B8S</b>	<b>94201</b>									.030
2016-13	L4 1.6L	Naturally Aspirated	PLZKBR7B8DG	90223									.032
		Turbo	PLZKBR7B8DG	90223									.026
2012-11	L4 1.6L	Naturally Aspirated, Eng Desg N16B16A	PLZKBR7B8DG	90223									.032
		Turbo, Eng Desg N18B16A	PLZKBR7B8DG	90223									.026
<b>Cooper Paceman</b>													
2016-13	L4 1.6L	Naturally Aspirated	PLZKBR7B8DG	90223									.032
		Turbo	PLZKBR7B8DG	90223									.026
<b>MITSUBISHI</b>													
<b>3000GT</b>													
1999-97	V6 3.0L	DOHC	<b>PFR6J-11</b>	<b>2743</b>	FR6BHX-S	95159	BKR6EIX-11	3764	BKR6EGP	7092	BKR6E-11	2756	.044
		SOHC	<b>BPR5ES-11</b>	<b>7634</b>				BPR5EIX-11	2115	BPR5EGP	7082	BPR5EY-11	6937





Year	Cyl. L	Notes	Original Equipment		Ruthenium HX		Iridium IX		G-Power		V-Power		Gap
			Part	Stock	Part	Stock	Part	Stock	Part	Stock	Part	Stock	
<b>MITSUBISHI (Cont'd)</b>													
<b>3000GT (Cont'd)</b>													
1996-91	V6 3.0L	DOHC	<b>PFR6J-11</b>	<b>2743</b>			BKR6EIX-11	3764	BKR6EGP	7092	BKR6E-11	2756	.044
Cordia													
1988-85	L4 1.8L		<b>BPR7ES-11</b>	<b>7226</b>			BPR7EIX	4055					.044
	L4 2.0L		<b>BPR6ES-11</b>	<b>7133</b>			BPR6EIX-11	3903	BPR6EGP	7084	BPR6EY-11	6261	.044
Diamante													
2004-97	V6 3.5L		PFR5J-11	4642	FR5AHX	95839	BKR5EIX-11	5464	BKR5EGP	7090	BKR5E-11	6953	.044
1996	V6 3.0L		<b>BPR6ES-11</b>	<b>7133</b>			BPR6EIX-11	3903	BPR6EGP	7084	BPR6EY-11	6261	.044
1995	V6 3.0L	Vin H	<b>BPR6ES-11</b>	<b>7133</b>			BPR6EIX-11	3903	BPR6EGP	7084	BPR6EY-11	6261	.044
		Vin J	<b>PFR6J-11</b>	<b>2743</b>			BKR6EIX-11	3764	BKR6EGP	7092	BKR6E-11	2756	.044
1994-93	V6 3.0L	Vin H	<b>BPR6ES-11</b>	<b>7133</b>			BPR6EIX-11	3903	BPR6EGP	7084	BPR6EY-11	6261	.044
		Vin J	<b>PFR6J-11</b>	<b>2743</b>			BKR6EIX-11	3764	BKR6EGP	7092	BKR6E-11	2756	.044
		Vin S	<b>BPR6ES-11</b>	<b>7133</b>			BPR6EIX-11	3903	BPR6EGP	7084	BPR6EY-11	6261	.044
1992	V6 3.0L	Vin B	<b>PFR6J-11</b>	<b>2743</b>			BKR6EIX-11	3764	BKR6EGP	7092	BKR6E-11	2756	.044
		Vin S	<b>BPR6ES-11</b>	<b>7133</b>			BPR6EIX-11	3903	BPR6EGP	7084	BPR6EY-11	6261	.044
Eclipse													
2012-06	L4 2.4L		<b>LZFR6AI</b>	<b>3656</b>	LFR6BHX	93420	LFR6AIX	93893	LFR6CGP	1483			.032
	V6 3.8L		<b>IFR6B-K</b>	<b>4867</b>	FR6AHX-S	94279	BKR6EIX	6418	BKR6EGP	7092	BKR6EYA	7990	.032
2005-04	L4 2.4L		<b>BKR5E-11</b>	<b>6953</b>	FR5BHX	96457	BKR5EIX-11	5464	BKR5EGP	7090	BKR5E-11	6953	.044
	V6 3.0L	GT	<b>FR5EI</b>	<b>1313</b>	FR5AHX	95839	BKR5EIX	6341	BKR5EGP	7090	BKR5E	7938	.032
		GTS	<b>FR6EI</b>	<b>2687</b>	FR6BHX-S	95159	BKR6EIX	6418	BKR6EGP	7092	BKR6E	6962	.032
		Spyder GT	<b>FR5EI</b>	<b>1313</b>	FR5AHX	95839	BKR5EIX	6341	BKR5EGP	7090	BKR5E	7938	.032
		Spyder GTS	<b>FR6EI</b>	<b>2687</b>	FR6BHX-S	95159	BKR6EIX	6418	BKR6EGP	7092	BKR6E	6962	.032
2003	L4 2.4L		<b>BKR5E-11</b>	<b>6953</b>	FR5BHX	96457	BKR5EIX-11	5464	BKR5EGP	7090	BKR5E-11	6953	.044
	V6 3.0L	GT	<b>PFR5G-11</b>	<b>2647</b>	FR5AHX	95839	BKR5EIX-11	5464	BKR5EGP	7090	BKR5E-11	6953	.044
		GTS	<b>IFR6B</b>	<b>6507</b>	FR6BHX-S	95159	BKR6EIX	6418	BKR6EGP	7092	BKR6E	6962	.032
		Spyder GT	<b>PFR5G-11</b>	<b>2647</b>	FR5AHX	95839	BKR5EIX-11	5464	BKR5EGP	7090	BKR5E-11	6953	.044
Spyder GTS	<b>IFR6B</b>	<b>6507</b>	FR6BHX-S	95159	BKR6EIX	6418	BKR6EGP	7092	BKR6E	6962	.032		
2002-01	L4 2.4L		<b>BKR5E-11</b>	<b>6953</b>	FR5BHX	96457	BKR5EIX-11	5464	BKR5EGP	7090	BKR5E-11	6953	.044
	V6 3.0L		<b>PFR5G-11</b>	<b>2647</b>	FR5AHX	95839	BKR5EIX-11	5464	BKR5EGP	7090	BKR5E-11	6953	.044
2000	L4 2.4L		<b>BKR5E-11</b>	<b>6953</b>	FR5BHX	96457	BKR5EIX-11	5464	BKR5EGP	7090	BKR5E-11	6953	.044
	V6 3.0L		<b>PFR6G-11</b>	<b>5555</b>	FR6AHX-S	94279	BKR6EIX-11	3764	BKR6EGP	7092	BKR6E-11	2756	.044
1999	L4 2.0L	Naturally Aspirated	BKR6E-11	2756	FR6BHX-S	95159	BKR6EIX-11	3764	BKR6EGP	7092	BKR6E-11	2756	.050
		Turbo	<b>BPR6EKN</b>	<b>6757</b>			BPR6EIX	6637	BPR6EGP	7084			.032
L4 2.4L			<b>BKR5E-11</b>	<b>6953</b>	FR5BHX	96457	BKR5EIX-11	5464	BKR5EGP	7090	BKR5E-11	6953	.044
	1998-97	L4 2.0L	Naturally Aspirated	BKR6E	6962	FR6BHX-S	95159	BKR6EIX	6418	BKR6EGP	7092	BKR6E	6962
Turbo		<b>BPR6EKN</b>	<b>6757</b>			BPR6EIX	6637	BPR6EGP	7084			.032	
L4 2.4L			<b>BKR5E-11</b>	<b>6953</b>	FR5BHX	96457	BKR5EIX-11	5464	BKR5EGP	7090	BKR5E-11	6953	.044
	1996	L4 2.0L	Naturally Aspirated	BKR6E	6962		BKR6EIX	6418	BKR6EGP	7092	BKR6E	6962	.035
Turbo		<b>BPR6EKN</b>	<b>6757</b>			BPR6EIX	6637	BPR6EGP	7084			.032	
L4 2.4L			<b>BKR5E-11</b>	<b>6953</b>			BKR5EIX-11	5464	BKR5EGP	7090	BKR5E-11	6953	.044
1995	L4 2.0L	Naturally Aspirated	BKR6E	6962			BKR6EIX	6418	BKR6EGP	7092	BKR6E	6962	.035
		Turbo	<b>BPR6EKN</b>	<b>6757</b>			BPR6EIX	6637	BPR6EGP	7084			.032
1994-90	L4 1.8L		<b>BPR6ES-11</b>	<b>7133</b>			BPR6EIX-11	3903	BPR6EGP	7084	BPR6EY-11	6261	.044
	L4 2.0L	Naturally Aspirated	<b>BPR6ES-11</b>	<b>7133</b>			BPR6EIX-11	3903	BPR6EGP	7084	BPR6EY-11	6261	.044
		Turbo	<b>BPR6ES</b>	<b>7131</b>			BPR6EIX	6637	BPR6EGP	7084	BPR6EY	6427	.032
Endeavor													
2011-10	V6 3.8L		<b>FR6EI</b>	<b>2687</b>	FR6BHX-S	95159	BKR6EIX	6418	BKR6EGP	7092	BKR6E	6962	.032
2008-04	V6 3.8L		<b>FR6EI</b>	<b>2687</b>	FR6BHX-S	95159	BKR6EIX	6418	BKR6EGP	7092	BKR6E	6962	.032
Expo													
1995-93	L4 2.4L		<b>BKR5E-11</b>	<b>6953</b>			BKR5EIX-11	5464	BKR5EGP	7090	BKR5E-11	6953	.044
1992	L4 2.4L		<b>BPR6ES-11</b>	<b>7133</b>			BPR6EIX-11	3903	BPR6EGP	7084	BPR6EY-11	6261	.044
Expo LRV													
1994-93	L4 1.8L		<b>BKR5E-11</b>	<b>6953</b>			BKR5EIX-11	5464	BKR5EGP	7090	BKR5E-11	6953	.044
	L4 2.4L		<b>BKR5E-11</b>	<b>6953</b>			BKR5EIX-11	5464	BKR5EGP	7090	BKR5E-11	6953	.044
1992	L4 1.8L		<b>BKR5E-11</b>	<b>6953</b>			BKR5EIX-11	5464	BKR5EGP	7090	BKR5E-11	6953	.044
Galant													
2012-10	L4 2.4L		<b>LZFR6AI</b>	<b>3656</b>	LFR6BHX	93420	LFR6AIX	93893	LFR6CGP	1483			.032

**Bold denotes NGK OE Manufacturer and/or OE Service Part**  
NOT BOLD denotes OE Equivalent Part

**Le texte en gras désigne une pièce d'équipement originale du manufacturier NGK et/ou pièce d'équipement originale de service**  
Le texte non en gras désigne une pièce d'équipement originale équivalente

Note: Due to different operating or engine conditions, alternate heat range plugs may be required.

Note: En raison de différences au niveau du fonctionnement ou des conditions du moteur, d'autres types de bougies avec variation de chaleur peuvent être nécessaires



Year	Cyl. L	Notes	Original Equipment		Ruthenium HX		Iridium IX		G-Power		V-Power		Gap
			Part	Stock	Part	Stock	Part	Stock	Part	Stock	Part	Stock	
<b>MITSUBISHI (Cont'd)</b>													
<b>Galant (Cont'd)</b>													
2009	L4 2.4L		<b>LZFR6AI</b>	<b>3656</b>	LFR6BHX	93420	LFR6AIX	93893	LFR6CGP	1483			.032
		GT	<b>FR6EI</b>	<b>2687</b>	FR6AHX-S	94279	BKR6EIX	6418	BKR6EGP	7092	BKR6E	6962	.032
	V6 3.8L	Ralliart	<b>IFR6B-K</b>	<b>4867</b>	FR6AHX-S	94279	BKR6EIX	6418	BKR6EGP	7092	BKR6EYA	7990	.032
		Sport V6	<b>FR6EI</b>	<b>2687</b>	FR6AHX-S	94279	BKR6EIX	6418	BKR6EGP	7092	BKR6E	6962	.032
2008	L4 2.4L		<b>LZFR6AI</b>	<b>3656</b>	LFR6BHX	93420	LFR6AIX	93893	LFR6CGP	1483			.032
	V6 3.8L		<b>IFR6B-K</b>	<b>4867</b>	FR6AHX-S	94279	BKR6EIX	6418	BKR6EGP	7092	BKR6EYA	7990	.032
2007	L4 2.4L		<b>LZFR6AI</b>	<b>3656</b>	LFR6BHX	93420	LFR6AIX	93893	LFR6CGP	1483			.032
	V6 3.8L	GTS	<b>FR6EI</b>	<b>2687</b>	FR6AHX-S	94279	BKR6EIX	6418	BKR6EGP	7092	BKR6E	6962	.032
		Ralliart	<b>IFR6B-K</b>	<b>4867</b>	FR6AHX-S	94279	BKR6EIX	6418	BKR6EGP	7092	BKR6EYA	7990	.032
2006-04	L4 2.4L		<b>LZFR6AI</b>	<b>3656</b>	LFR6BHX	93420	LFR6AIX	93893	LFR6CGP	1483			.032
	V6 3.8L		<b>FR6EI</b>	<b>2687</b>	FR6BHX-S	95159	BKR6EIX	6418	BKR6EGP	7092	BKR6E	6962	.032
2003-01	L4 2.4L		<b>BKR5E-11</b>	<b>6953</b>	FR5BHX	96457	BKR5EIX-11	5464	BKR5EGP	7090	BKR5E-11	6953	.044
	V6 3.0L		<b>PFR5G-11</b>	<b>2647</b>	FR5AHX	95839	BKR5EIX-11	5464	BKR5EGP	7090	BKR5E-11	6953	.044
2000-99	L4 2.4L		<b>BKR5E-11</b>	<b>6953</b>	FR5BHX	96457	BKR5EIX-11	5464	BKR5EGP	7090	BKR5E-11	6953	.044
	V6 3.0L		<b>PFR6G-11</b>	<b>5555</b>	FR6AHX-S	94279	BKR6EIX-11	3764	BKR6EGP	7092	BKR6E-11	2756	.044
1998-97	L4 2.4L		<b>BKR5E-11</b>	<b>6953</b>	FR5AHX	95839	BKR5EIX-11	5464	BKR5EGP	7090	BKR5E-11	6953	.044
1996-95	L4 2.4L		<b>BKR5E-11</b>	<b>6953</b>			BKR5EIX-11	5464	BKR5EGP	7090	BKR5E-11	6953	.044
		DOHC	<b>BPR6ES-11</b>	<b>7133</b>			BPR6EIX-11	3903	BPR6EGP	7084	BPR6EY-11	6261	.044
1994	L4 2.4L	SOHC	<b>BKR5E-11</b>	<b>6953</b>			BKR5EIX-11	5464	BKR5EGP	7090	BKR5E-11	6953	.044
			<b>BKR5E-11</b>	<b>6953</b>			BKR5EIX-11	5464	BKR5EGP	7090	BKR5E-11	6953	.044
1993	L4 2.0L		<b>BKR5E-11</b>	<b>6953</b>			BKR5EIX-11	5464	BKR5EGP	7090	BKR5E-11	6953	.044
1992-91	L4 2.0L	Naturally Aspirated	<b>BPR6ES-11</b>	<b>7133</b>			BPR6EIX-11	3903	BPR6EGP	7084	BPR6EY-11	6261	.044
		Turbo	<b>BPR6ES</b>	<b>7131</b>			BPR6EIX	6637	BPR6EGP	7084	BPR6EY	6427	.032
1990-89	L4 2.0L		<b>BPR6ES-11</b>	<b>7133</b>			BPR6EIX-11	3903	BPR6EGP	7084	BPR6EY-11	6261	.044
1988	V6 3.0L		<b>PGR5A-11</b>	<b>3573</b>			BPR5EIX-11	2115	BPR5EGP	7082	BPR5EY-11	6937	.044
1987-85	L4 2.4L		<b>BPR5ES-11</b>	<b>7634</b>			BPR5EIX-11	2115	BPR5EGP	7082	BPR5EY-11	6937	.044
<b>Lancer</b>													
2017-16	L4 2.0L		<b>DIFR6C11</b>	<b>1312</b>	FR6AHX-S	94279	BKR6EIX-11	3764	BKR6EGP	7092			.044
	L4 2.4L		<b>DIFR5C11</b>	<b>1311</b>	FR5AHX	95839	BKR5EIX-11	5464	BKR5EGP	7090			.044
2015-12	L4 2.0L	Evolution GSR, Turbo	<b>DILKR8B6</b>	<b>91448</b>									.024
		Evolution MR, Turbo	<b>DILKR8B6</b>	<b>91448</b>									.024
		Naturally Aspirated	<b>DIFR6C11</b>	<b>1312</b>	FR6AHX-S	94279	BKR6EIX-11	3764	BKR6EGP	7092			.044
		Ralliart, Turbo	<b>DILKR7B6</b>	<b>96957</b>									.024
2011	L4 2.0L	Evolution GSR, Turbo	<b>DILKR8B6</b>	<b>91448</b>									.024
		Evolution MR, Turbo	<b>DILKR8B6</b>	<b>91448</b>									.024
		Evolution MR Touring, Turbo	<b>DILKR8B6</b>	<b>91448</b>									.024
		Naturally Aspirated	<b>DIFR6C11</b>	<b>1312</b>	FR6AHX-S	94279	BKR6EIX-11	3764	BKR6EGP	7092			.044
		Ralliart, Turbo	<b>DILKR7B6</b>	<b>96957</b>									.024
		Ralliart Sportback, Turbo	<b>DILKR7B6</b>	<b>96957</b>									.024
	L4 2.4L		<b>DIFR5C11</b>	<b>1311</b>	FR5AHX	95839	BKR5EIX-11	5464	BKR5EGP	7090			.044
2010	L4 2.0L	Evolution GSR, Turbo	<b>ILKR8E6</b>	<b>1422</b>									.024
		Evolution MR, Turbo	<b>ILKR8E6</b>	<b>1422</b>									.024
		Evolution MR Touring, Turbo	<b>ILKR8E6</b>	<b>1422</b>									.024
		Naturally Aspirated	<b>FR6EI</b>	<b>2687</b>	FR6BHX-S	95159	BKR6EIX	6418	BKR6EGP	7092	BKR6E	6962	.032
		Ralliart, Turbo	<b>ILKR7E6</b>	<b>93053</b>									.024
	Ralliart Sportback, Turbo	<b>ILKR7E6</b>	<b>93053</b>									.024	
L4 2.4L		<b>FR5EI</b>	<b>1313</b>	FR5AHX	95839	BKR5EIX	6341	BKR5EGP	7090	BKR5E	7938	.032	
2009	L4 2.0L	Evolution GSR, Turbo	<b>ILKR8E6</b>	<b>1422</b>									.024
		Evolution MR, Turbo	<b>ILKR8E6</b>	<b>1422</b>									.024
		Evolution RS, Turbo	<b>ILKR8E6</b>	<b>1422</b>									.024
		Naturally Aspirated	<b>FR6EI</b>	<b>2687</b>	FR6BHX-S	95159	BKR6EIX	6418	BKR6EGP	7092	BKR6E	6962	.032
		Ralliart, Turbo, From 12/1/2008	<b>ILKR7E6</b>	<b>93053</b>									.024
		Ralliart, Turbo, To 11/3/2008	<b>ILKR8E6</b>	<b>1422</b>									.024



Year	Cyl. L	Notes	Original Equipment		Ruthenium HX		Iridium IX		G-Power		V-Power		Gap
			Part	Stock	Part	Stock	Part	Stock	Part	Stock	Part	Stock	
<b>MITSUBISHI (Cont'd)</b>													
<b>Lancer (Cont'd)</b>													
2009	L4 2.4L		<b>FR5EI</b>	<b>1313</b>	FR5AHX	95839	BKR5EIX	6341	BKR5EGP	7090	BKR5E	7938	.032
2008	L4 2.0L	Naturally Aspirated	<b>FR6EI</b>	<b>2687</b>	FR6BHX-S	95159	BKR6EIX	6418	BKR6EGP	7092	BKR6E	6962	.032
		Turbo	<b>ILKR8E6</b>	<b>1422</b>									.024
2007	L4 2.0L		<b>BKR5E-11</b>	<b>6953</b>	FR5BHX	96457	BKR5EIX-11	5464	BKR5EGP	7090	BKR5E-11	6953	.044
2006	L4 2.0L	Naturally Aspirated	<b>BKR5E-11</b>	<b>6953</b>	FR5BHX	96457	BKR5EIX-11	5464	BKR5EGP	7090	BKR5E-11	6953	.044
		Turbo	<b>ILFR7H</b>	<b>5245</b>			LF7AIX	2309					.024
	L4 2.4L		<b>LZFR6AI</b>	<b>3656</b>	LF6BHX	93420	LF6AIX	93893	LF6CGP	1483			.032
2005-04	L4 2.0L	Naturally Aspirated	<b>BKR5E-11</b>	<b>6953</b>	FR5BHX	96457	BKR5EIX-11	5464	BKR5EGP	7090	BKR5E-11	6953	.044
		Turbo	<b>IGR7A-G</b>	<b>3106</b>			BPR7EIX	4055					.028
	L4 2.4L		<b>LZFR6AI</b>	<b>3656</b>	LF6BHX	93420	LF6AIX	93893	LF6CGP	1483			.032
2003	L4 2.0L	Naturally Aspirated	<b>BKR5E-11</b>	<b>6953</b>	FR5BHX	96457	BKR5EIX-11	5464	BKR5EGP	7090	BKR5E-11	6953	.044
		Turbo	<b>IGR7A-G</b>	<b>3106</b>			BPR7EIX	4055					.028
2002	L4 2.0L		<b>BKR5E-11</b>	<b>6953</b>	FR5BHX	96457	BKR5EIX-11	5464	BKR5EGP	7090	BKR5E-11	6953	.044
<b>Mighty Max</b>													
1996-95	L4 2.4L		<b>BPR6ES-11</b>	<b>7133</b>			BPR6EIX-11	3903	BPR6EGP	7084	BPR6EY-11	6261	.044
1994-90	L4 2.4L		<b>BPR6ES-11</b>	<b>7133</b>			BPR6EIX-11	3903	BPR6EGP	7084	BPR6EY-11	6261	.044
		V6 3.0L	<b>BPR5ES-11</b>	<b>7634</b>			BPR5EIX-11	2115	BPR5EGP	7082	BPR5EY-11	6937	.044
1989-86	L4 2.0L		<b>BPR6ES-11</b>	<b>7133</b>			BPR6EIX-11	3903	BPR6EGP	7084	BPR6EY-11	6261	.044
		L4 2.6L	<b>BPR6ES-11</b>	<b>7133</b>			BPR6EIX-11	3903	BPR6EGP	7084	BPR6EY-11	6261	.044
1985	L4 2.0L		<b>BPR6ES-11</b>	<b>7133</b>			BPR6EIX-11	3903	BPR6EGP	7084	BPR6EY-11	6261	.044
	L4 2.3L	DIESEL	Y-115R1	2161									
	L4 2.6L		<b>BPR5ES-11</b>	<b>7634</b>			BPR5EIX-11	2115	BPR5EGP	7082	BPR5EY-11	6937	.044
<b>Mirage</b>													
2015-14	L3 1.2L		<b>LZFR5BI-11</b>	<b>93298</b>	LF5AHX	96355	LF5AIX-11	4469	LF5AGP	5018			.044
2002-00	L4 1.5L		<b>BPR5EKU</b>	<b>5685</b>									.032
		L4 1.8L	<b>BKR5E-11</b>	<b>6953</b>	FR5BHX	96457	BKR5EIX-11	5464	BKR5EGP	7090	BKR5E-11	6953	.044
1999-97	L4 1.5L		<b>BPR5ES-11</b>	<b>7634</b>			BPR5EIX-11	2115	BPR5EGP	7082	BPR5EY-11	6937	.044
		L4 1.8L	<b>BKR5E-11</b>	<b>6953</b>	FR5BHX	96457	BKR5EIX-11	5464	BKR5EGP	7090	BKR5E-11	6953	.044
1996-93	L4 1.5L		<b>BPR5ES-11</b>	<b>7634</b>			BPR5EIX-11	2115	BPR5EGP	7082	BPR5EY-11	6937	.044
		L4 1.8L	<b>BKR5E-11</b>	<b>6953</b>			BKR5EIX-11	5464	BKR5EGP	7090	BKR5E-11	6953	.044
1992-91	L4 1.5L		<b>BPR5ES-11</b>	<b>7634</b>			BPR5EIX-11	2115	BPR5EGP	7082	BPR5EY-11	6937	.044
		L4 1.6L	<b>BPR6ES-11</b>	<b>7133</b>			BPR6EIX-11	3903	BPR6EGP	7084	BPR6EY-11	6261	.044
1990	L4 1.5L		<b>BPR6ES-11</b>	<b>7133</b>			BPR6EIX-11	3903	BPR6EGP	7084	BPR6EY-11	6261	.044
1989	L4 1.5L		<b>BPR6ES-11</b>	<b>7133</b>			BPR6EIX-11	3903	BPR6EGP	7084	BPR6EY-11	6261	.044
		L4 1.6L	<b>BPR6ES</b>	<b>7131</b>			BPR6EIX	6637	BPR6EGP	7084	BPR6EY	6427	.032
1988-85	L4 1.5L		<b>BPR6ES-11</b>	<b>7133</b>			BPR6EIX-11	3903	BPR6EGP	7084	BPR6EY-11	6261	.044
		L4 1.6L	<b>BPR7ES-11</b>	<b>7226</b>			BPR7EIX	4055					.044
<b>Montero</b>													
2006-03	V6 3.8L		<b>IFR6B</b>	<b>6507</b>	FR6BHX-S	95159	BKR6EIX	6418	BKR6EGP	7092	BKR6E	6962	.032
2002-97	V6 3.5L		PFR5J-11	4642	FR5BHX	96457	BKR5EIX-11	5464	BKR5EGP	7090	BKR5E-11	6953	.044
1996-95	V6 3.0L		<b>PFR6J-11</b>	<b>2743</b>			BKR6EIX-11	3764	BKR6EGP	7092	BKR6E-11	2756	.044
		V6 3.5L	<b>PFR5J-11</b>	<b>4642</b>			BKR5EIX-11	5464	BKR5EGP	7090	BKR5E-11	6953	.044
1994	V6 3.0L		<b>BPR5ES-11</b>	<b>7634</b>			BPR5EIX-11	2115	BPR5EGP	7082	BPR5EY-11	6937	.044
		V6 3.5L	<b>PFR5J-11</b>	<b>4642</b>			BKR5EIX-11	5464	BKR5EGP	7090	BKR5E-11	6953	.044
1993-90	V6 3.0L		<b>BPR5ES-11</b>	<b>7634</b>			BPR5EIX-11	2115	BPR5EGP	7082	BPR5EY-11	6937	.044
1989	L4 2.6L		<b>BPR6ES-11</b>	<b>7133</b>			BPR6EIX-11	3903	BPR6EGP	7084	BPR6EY-11	6261	.044
		V6 3.0L	<b>BPR5ES-11</b>	<b>7634</b>			BPR5EIX-11	2115	BPR5EGP	7082	BPR5EY-11	6937	.044
1988-86	L4 2.6L		<b>BPR6ES-11</b>	<b>7133</b>			BPR6EIX-11	3903	BPR6EGP	7084	BPR6EY-11	6261	.044
1985	L4 2.6L		<b>BPR5ES-11</b>	<b>7634</b>			BPR5EIX-11	2115	BPR5EGP	7082	BPR5EY-11	6937	.044
<b>Montero Sport</b>													
2004	V6 3.5L		PFR5J-11	4642	FR5BHX	96457	BKR5EIX-11	5464	BKR5EGP	7090	BKR5E-11	6953	.044
2003-00	V6 3.0L		<b>IFR5E11</b>	<b>7994</b>	FR5BHX	96457	BKR5EIX-11	5464	BKR5EGP	7090	BKR5E-11	6953	.044
		V6 3.5L	PFR5J-11	4642	FR5BHX	96457	BKR5EIX-11	5464	BKR5EGP	7090	BKR5E-11	6953	.044
1999	L4 2.4L		<b>BKR5E-11</b>	<b>6953</b>	FR5AHX	95839	BKR5EIX-11	5464	BKR5EGP	7090	BKR5E-11	6953	.044
		V6 3.0L	<b>IFR5E11</b>	<b>7994</b>	FR5BHX	96457	BKR5EIX-11	5464	BKR5EGP	7090	BKR5E-11	6953	.044
		V6 3.5L	PFR5J-11	4642	FR5BHX	96457	BKR5EIX-11	5464	BKR5EGP	7090	BKR5E-11	6953	.044
1998-97	L4 2.4L		<b>BKR5E-11</b>	<b>6953</b>	FR5AHX	95839	BKR5EIX-11	5464	BKR5EGP	7090	BKR5E-11	6953	.044

**Bold denotes NGK OE Manufacturer and/or OE Service Part**  
NOT BOLD denotes OE Equivalent Part

**Le texte en gras désigne une pièce d'équipement originale du manufacturier NGK et/ou pièce d'équipement originale de service**  
Le texte non en gras désigne une pièce d'équipement originale équivalente

Note: Due to different operating or engine conditions, alternate heat range plugs may be required.

Note: En raison de différences au niveau du fonctionnement ou des conditions du moteur, d'autres types de bougies avec variation de chaleur peuvent être nécessaires



Year	Cyl. L	Notes	Original Equipment		Ruthenium HX		Iridium IX		G-Power		V-Power		Gap
			Part	Stock	Part	Stock	Part	Stock	Part	Stock	Part	Stock	
<b>MITSUBISHI (Cont'd)</b>													
<b>Montero Sport (Cont'd)</b>													
1998-97	V6 3.0L		<b>PFR6J-11</b>	<b>2743</b>	FR6BHX-S	95159	BKR6EIX-11	3764	BKR6EGP	7092	BKR6E-11	2756	.044
<b>Outlander</b>													
2018	L4 2.4L		<b>DILKR6D11G</b>	<b>95264</b>									.044
2017-14	L4 2.4L		<b>DILKR6D11G</b>	<b>95264</b>									.044
	V6 3.0L		<b>DILKR7C11</b>	<b>94731</b>	LKR7AHX-S	96358	LKR7DIX-11S	93175	LKR7BGP-S	97390			.032
2013-11	L4 2.4L		<b>DIFR5C11</b>	<b>1311</b>	FR5AHX	95839	BKR5EIX-11	5464	BKR5EGP	7090			.044
	V6 3.0L		<b>ILKR7B8</b>	<b>1989</b>	LKR7BHX	94705	LKR7AIX	93911	LKR7BGP-8	95983			.032
2010-08	L4 2.4L		<b>FR5EI</b>	<b>1313</b>	FR5AHX	95839	BKR5EIX	6341	BKR5EGP	7090	BKR5E	7938	.032
	V6 3.0L		<b>ILKR7B8</b>	<b>1989</b>	LKR7BHX	94705	LKR7AIX	93911	LKR7BGP-8	95983			.032
2007	V6 3.0L		<b>ILKR7B8</b>	<b>1989</b>	LKR7BHX	94705	LKR7AIX	93911	LKR7BGP-8	95983			.032
2006-04	L4 2.4L		<b>LZFR6AI</b>	<b>3656</b>	LFR6BHX	93420	LFR6AIX	93893	LFR6CGP	1483			.032
2003	L4 2.4L		<b>BKR5E-11</b>	<b>6953</b>	FR5BHX	96457	BKR5EIX-11	5464	BKR5EGP	7090	BKR5E-11	6953	.044
<b>Outlander Sport</b>													
2018	L4 2.4L		<b>DIFR5C11</b>	<b>1311</b>	FR5AHX	95839	BKR5EIX-11	5464	BKR5EGP	7090			.044
2017-15	L4 2.0L		<b>DIFR6C11</b>	<b>1312</b>	FR6AHX-S	94279	BKR6EIX-11	3764	BKR6EGP	7092			.044
	L4 2.4L		<b>DIFR5C11</b>	<b>1311</b>	FR5AHX	95839	BKR5EIX-11	5464	BKR5EGP	7090			.044
2014-11	L4 2.0L		<b>DIFR6C11</b>	<b>1312</b>	FR6AHX-S	94279	BKR6EIX-11	3764	BKR6EGP	7092			.044
<b>Precis</b>													
1994-87	L4 1.5L		<b>BPR6ES-11</b>	<b>7133</b>			BPR6EIX-11	3903	BPR6EGP	7084	BPR6EY-11	6261	.044
<b>Raider</b>													
2009	V6 3.7L		<b>ZFR6F-11G</b>	<b>6987</b>	FR6BHX-S	95159	ZFR6FIX-11	6441	ZFR6FGP	7100	ZFR6F-11G	6987	.044
2008	V6 3.7L		<b>ZFR6F-11G</b>	<b>6987</b>	FR6AHX-S	94279	ZFR6FIX-11	6441	ZFR6FGP	7100	ZFR6F-11G	6987	.044
2007-06	V6 3.7L		<b>ZFR6F-11G</b>	<b>6987</b>	FR6AHX-S	94279	ZFR6FIX-11	6441	ZFR6FGP	7100	ZFR6F-11G	6987	.044
	V8 4.7L	Magnum, Vin N, w/o High Output Engine	ZFR5F-11	2262	FR5AHX	95839	ZFR5FIX-11	2477	ZFR5FGP	7098	ZFR5F-11	2262	.044
<b>RVR</b>													
2018	L4 2.4L		<b>DIFR5C11</b>	<b>1311</b>	FR5AHX	95839	BKR5EIX-11	5464	BKR5EGP	7090			.044
2017-15	L4 2.0L		<b>DIFR6C11</b>	<b>1312</b>	FR6AHX-S	94279	BKR6EIX-11	3764	BKR6EGP	7092			.044
	L4 2.4L		<b>DIFR5C11</b>	<b>1311</b>	FR5AHX	95839	BKR5EIX-11	5464	BKR5EGP	7090			.044
2014-11	L4 2.0L		<b>DIFR6C11</b>	<b>1312</b>	FR6AHX-S	94279	BKR6EIX-11	3764	BKR6EGP	7092			.044
<b>Sigma</b>													
1990-89	V6 3.0L		<b>PGR5A-11</b>	<b>3573</b>			BPR5EIX-11	2115	BPR5EGP	7082	BPR5EY-11	6937	.044
<b>Starion</b>													
1989	L4 2.6L		<b>BPR7ES-11</b>	<b>7226</b>			BPR7EIX	4055					.044
1988-85	L4 2.6L		<b>BPR6ES-11</b>	<b>7133</b>			BPR6EIX-11	3903	BPR6EGP	7084	BPR6EY-11	6261	.044
<b>Tredia</b>													
1988-85	L4 1.8L		<b>BPR7ES-11</b>	<b>7226</b>			BPR7EIX	4055					.044
	L4 2.0L		<b>BPR6ES-11</b>	<b>7133</b>			BPR6EIX-11	3903	BPR6EGP	7084	BPR6EY-11	6261	.044
<b>Van</b>													
1990-87	L4 2.4L						BPR6EIX-11	3903	BPR6EGP	7084	BPR6EY-11	6261	.044
<b>MORGAN</b>													
<b>4/4</b>													
1994-85	L4 1.6L		BCPR6ES	2330			BCPR6EIX	5689	BCPR6EGP	7088	BCPR6E	3735	.028
<b>Aero 8</b>													
2005-04	V8 4.4L		BKR6EKUB	7969	FR6AHX-S	94279	BKR6EIX	6418	BKR6EGP	7092	BKR6E	6962	.032
<b>Plus 8</b>													
1996-85	V8 3.5L		BPR6ES	7131			BPR6EIX	6637	BPR6EGP	7084	BPR6EY	6427	.032
<b>NISSAN</b>													
<b>200SX</b>													
1998-97	L4 1.6L		<b>BKR6E-11</b>	<b>2756</b>	FR6AHX-S	94279	BKR6EIX-11	3764	BKR6EGP	7092	BKR6E-11	2756	.044
	L4 2.0L		<b>PFR6B-11</b>	<b>4014</b>	FR6AHX-S	94279	BKR6EIX-11	3764	BKR6EGP	7092	BKR6E-11	2756	.044
1996-95	L4 1.6L		<b>BKR6E-11</b>	<b>2756</b>			BKR6EIX-11	3764	BKR6EGP	7092	BKR6E-11	2756	.044
	L4 2.0L		<b>PFR6B-11</b>	<b>4014</b>			BKR6EIX-11	3764	BKR6EGP	7092	BKR6E-11	2756	.044
1988	L4 2.0L	Dual Plug; Exhaust Side (4 Req'd)	<b>BCPR5ES-11</b>	<b>6696</b>			BCPR5EIX-11	3306	BCPR5EGP	7086	BCPR5E-11	1273	.044
		Dual Plug; Intake Side (4 Req'd)	<b>BCPR6ES-11</b>	<b>6779</b>			BCPR6EIX-11	4919	BCPR6EGP	7088	BCPR6E-11	5632	.044
	V6 3.0L		<b>BCPR6ES-11</b>	<b>6779</b>			BCPR6EIX-11	4919	BCPR6EGP	7088	BCPR6E-11	5632	.044





Year	Cyl. L	Notes	Original Equipment		Ruthenium HX		Iridium IX		G-Power		V-Power		Gap
			Part	Stock	Part	Stock	Part	Stock	Part	Stock	Part	Stock	
<b>NISSAN (Cont'd)</b>													
<b>200SX (Cont'd)</b>													
1987	L4 1.8L	Dual Plug; Exhaust Side (4 Req'd)	<b>BCPR5ES-11</b>	<b>6696</b>			BCPR5EIX-11	3306	BCPR5EGP	7086	BCPR5E-11	1273	.044
		Dual Plug; Intake Side (4 Req'd)	<b>BCPR6ES-11</b>	<b>6779</b>			BCPR6EIX-11	4919	BCPR6EGP	7088	BCPR6E-11	5632	.044
	L4 2.0L	Dual Plug; Exhaust Side (4 Req'd)	<b>BCPR5ES-11</b>	<b>6696</b>			BCPR5EIX-11	3306	BCPR5EGP	7086	BCPR5E-11	1273	.044
		Dual Plug; Intake Side (4 Req'd)	<b>BCPR6ES-11</b>	<b>6779</b>			BCPR6EIX-11	4919	BCPR6EGP	7088	BCPR6E-11	5632	.044
	V6 3.0L		<b>BCPR6ES-11</b>	<b>6779</b>			BCPR6EIX-11	4919	BCPR6EGP	7088	BCPR6E-11	5632	.044
1986-85	L4 1.8L	Dual Plug; Exhaust Side (4 Req'd)	<b>BCPR5ES-11</b>	<b>6696</b>			BCPR5EIX-11	3306	BCPR5EGP	7086	BCPR5E-11	1273	.044
		Dual Plug; Intake Side (4 Req'd)	<b>BCPR6ES-11</b>	<b>6779</b>			BCPR6EIX-11	4919	BCPR6EGP	7088	BCPR6E-11	5632	.044
	L4 2.0L	Dual Plug; Exhaust Side (4 Req'd)	<b>BCPR5ES-11</b>	<b>6696</b>			BCPR5EIX-11	3306	BCPR5EGP	7086	BCPR5E-11	1273	.044
		Dual Plug; Intake Side (4 Req'd)	<b>BCPR6ES-11</b>	<b>6779</b>			BCPR6EIX-11	4919	BCPR6EGP	7088	BCPR6E-11	5632	.044
<b>240SX</b>													
1998-97	L4 2.4L		<b>PFR5C-11</b>	<b>2271</b>	FR5AHX	95839	BKR5EIX-11	5464	BKR5EGP	7090	BKR5E-11	6953	.044
1996-94	L4 2.4L		<b>PFR5C-11</b>	<b>2271</b>			BKR5EIX-11	5464	BKR5EGP	7090	BKR5E-11	6953	.044
1993-91	L4 2.4L		<b>BKR5E-11</b>	<b>6953</b>			BKR5EIX-11	5464	BKR5EGP	7090	BKR5E-11	6953	.044
1990	L4 2.4L		<b>ZFR5E-11</b>	<b>4435</b>			ZFR5FIX-11	2477	ZFR5EGP	7096	ZFR5E-11	4435	.044
1989	L4 2.4L		<b>ZFR5D-11</b>	<b>4936</b>					ZFR5EGP	7096	ZFR5E-11	4435	.044
<b>300ZX</b>													
1996-90	V6 3.0L	Naturally Aspirated	<b>PFR5B-11</b>	<b>2300</b>			BKR5EIX-11	5464	BKR5EGP	7090	BKR5E-11	6953	.044
		Turbo	<b>PFR5B-11B</b>	<b>2867</b>					ZFR5EGP	7096	ZFR5E-11	4435	.044
1989-85	V6 3.0L	Naturally Aspirated	<b>BCPR6ES-11</b>	<b>6779</b>			BCPR6EIX-11	4919	BCPR6EGP	7088	BCPR6E-11	5632	.044
		Turbo	<b>BCPR6E-11</b>	<b>5632</b>			BCPR6EIX-11	4919	BCPR6EGP	7088	BCPR6E-11	5632	.044
<b>350Z</b>													
2009-07	V6 3.5L		DILKAR7B11	1406	LKAR7AHX-S	92274	LKAR7BIX-11S	93501	LKAR7AGP-D	93220			.044
2006-03	V6 3.5L		<b>PLFR5A-11</b>	<b>6240</b>	LF5AHX	96355	LF5AIX-11	4469	LF5AGP	5018	LF5A-11	6376	.044
<b>370Z</b>													
2017-09	V6 3.7L		DF8H-11B	90174	LKAR8BHX	91784							.044
<b>720</b>													
1986-85	L4 2.0L	Dual Plug; Exhaust Side (4 Req'd)	<b>BPR5ES</b>	<b>7734</b>			BPR5EIX	6597	BPR5EGP	7082	BPR5EY	1233	.032
		Dual Plug; Intake Side (4 Req'd)	<b>BPR6ES</b>	<b>7131</b>			BPR6EIX	6637	BPR6EGP	7084	BPR6EY	6427	.032
	L4 2.4L	Dual Plug; Exhaust Side (4 Req'd)	<b>BPR5ES</b>	<b>7734</b>			BPR5EIX	6597	BPR5EGP	7082	BPR5EY	1233	.032
		Dual Plug; Intake Side (4 Req'd)	<b>BPR6ES</b>	<b>7131</b>			BPR6EIX	6637	BPR6EGP	7084	BPR6EY	6427	.032
	L4 2.5L	DIESEL	Y-112RS1	1132									
<b>Altima</b>													
2017-14	L4 2.5L		DF6H-11A	94702	LKAR6AHX	97292							.044
	V6 3.5L		DILKAR7B11	1406	LKAR7AHX-S	92274	LKAR7BIX-11S	93501	LKAR7AGP-D	93220			.044
2013	L4 2.5L	Coupe, CL32(MfrBodyCode)	<b>DILKAR6A11</b>	<b>9029</b>	LKAR6AHX	97292	LKAR6AIX-11	91187	LKAR6AGP	95830			.044
		Sedan, L33(MfrBodyCode)	DF6H-11A	94702	LKAR6AHX	97292							.044
	V6 3.5L		DILKAR7B11	1406	LKAR7AHX-S	92274	LKAR7BIX-11S	93501	LKAR7AGP-D	93220			.044
2012-07	L4 2.5L		<b>DILKAR6A11</b>	<b>9029</b>	LKAR6AHX	97292	LKAR6AIX-11	91187	LKAR6AGP	95830			.044
	V6 3.5L		DILKAR7B11	1406	LKAR7AHX-S	92274	LKAR7BIX-11S	93501	LKAR7AGP-D	93220			.044
2006-02	L4 2.5L		<b>PLFR5A-11</b>	<b>6240</b>	LF5AHX	96355	LF5AIX-11	4469	LF5AGP	5018	LF5A-11	6376	.044
	V6 3.5L		<b>PLFR5A-11</b>	<b>6240</b>	LF5AHX	96355	LF5AIX-11	4469	LF5AGP	5018	LF5A-11	6376	.044
2001-00	L4 2.4L		<b>PFR5G-11</b>	<b>2647</b>	FR5AHX	95839	BKR5EIX-11	5464	BKR5EGP	7090	BKR5E-11	6953	.044
1999	L4 2.4L		<b>FR5AP-10</b>	<b>6371</b>	FR5AHX	95839	BKR5EIX-11	5464	BKR5EGP	7090	BKR5E-11	6953	.039
1998-97	L4 2.4L		<b>BKR5E-11</b>	<b>6953</b>	FR5AHX	95839	BKR5EIX-11	5464	BKR5EGP	7090	BKR5E-11	6953	.044
1996-93	L4 2.4L		<b>BKR5E-11</b>	<b>6953</b>			BKR5EIX-11	5464	BKR5EGP	7090	BKR5E-11	6953	.044
<b>Armada</b>													
2017	V8 5.6L		<b>DILKAR7B11</b>	<b>1406</b>	LKAR7AHX-S	92274	LKAR7BIX-11S	93501	LKAR7AGP-D	93220			.044
2015-07	V8 5.6L	FLEX	<b>DILFR5A-11D</b>	<b>98376</b>	LF5AHX	96355	LF5AIX-11	4469	LF5AGP	5018			.044

**Bold denotes NGK OE Manufacturer and/or OE Service Part**  
NOT BOLD denotes OE Equivalent Part

**Le texte en gras désigne une pièce d'équipement originale du manufacturier NGK et/ou pièce d'équipement originale de service**  
Le texte non en gras désigne une pièce d'équipement originale équivalente

Note: Due to different operating or engine conditions, alternate heat range plugs may be required.

Note: En raison de différences au niveau du fonctionnement ou des conditions du moteur, d'autres types de bougies avec variation de chaleur peuvent être nécessaires





Year	Cyl. L	Notes	Original Equipment		Ruthenium HX		Iridium IX		G-Power		V-Power		Gap
			Part	Stock	Part	Stock	Part	Stock	Part	Stock	Part	Stock	
<b>NISSAN (Cont'd)</b>													
<b>Armada (Cont'd)</b>													
2015-07		GAS	<b>DILFR5A11</b>	<b>93759</b>	LFR5AHX	96355	LFR5AIX-11	4469	LFR5AGP	5018			.044
2006-05	V8 5.6L		<b>PLFR5A-11</b>	<b>6240</b>	LFR5AHX	96355	LFR5AIX-11	4469	LFR5AGP	5018	LFR5A-11	6376	.044
<b>Axxess</b>													
1995-90	L4 2.4L		<b>ZFR5E-11</b>	<b>4435</b>			ZFR5FIX-11	2477	ZFR5EGP	7096	ZFR5E-11	4435	.044
<b>Cube</b>													
2014-09	L4 1.8L		<b>DILKAR6A11</b>	<b>9029</b>	LKAR6AHX	97292	LKAR6AIX-11	91187	LKAR6AGP	95830			.044
<b>D21</b>													
1994-90	L4 2.4L		<b>ZFR5E-11</b>	<b>4435</b>			ZFR5FIX-11	2477	ZFR5EGP	7096	ZFR5E-11	4435	.044
	V6 3.0L		<b>BKR6EY</b>	<b>3696</b>			BKR6EIX	6418	BKR6EGP	7092	BKR6EY	3696	.032
1989-86	L4 2.4L	Dual Plug; Exhaust Side (4 Req'd)	<b>BPR5ES</b>	<b>7734</b>			BPR5EIX	6597	BPR5EGP	7082	BPR5EY	1233	.032
		Dual Plug; Intake Side (4 Req'd)	<b>BPR6ES</b>	<b>7131</b>			BPR6EIX	6637	BPR6EGP	7084	BPR6EY	6427	.032
	V6 3.0L		<b>BCPR5ES-11</b>	<b>6696</b>			BCPR5EIX-11	3306	BCPR5EGP	7086	BCPR5E-11	1273	.044
<b>Frontier</b>													
2017	L4 2.5L		<b>PLZKAR6A-11</b>	<b>5118</b>	LKAR6AHX	97292	LKAR6AIX-11	91187	LKAR6AGP	95830			.044
	V6 4.0L	Flex Fuel	<b>DILFR5A-11D</b>	<b>98376</b>	LFR5AHX	96355	LFR5AIX-11	4469	LFR5AGP	5018			.044
		GAS	<b>DILFR5A11</b>	<b>93759</b>	LFR5AHX	96355	LFR5AIX-11	4469	LFR5AGP	5018			.044
2016-07	L4 2.5L		<b>PLZKAR6A-11</b>	<b>5118</b>	LKAR6AHX	97292	LKAR6AIX-11	91187	LKAR6AGP	95830			.044
	V6 4.0L		<b>DILFR5A11</b>	<b>93759</b>	LFR5AHX	96355	LFR5AIX-11	4469	LFR5AGP	5018			.044
2006-05	L4 2.5L		<b>PLZKAR6A-11</b>	<b>5118</b>	LKAR6AHX	97292	LKAR6AIX-11	91187	LKAR6AGP	95830			.044
	V6 4.0L		<b>PLFR5A-11</b>	<b>6240</b>	LFR5AHX	96355	LFR5AIX-11	4469	LFR5AGP	5018	LFR5A-11	6376	.044
2004-01	L4 2.4L		<b>PFR5G-11</b>	<b>2647</b>	FR5AHX	95839	BKR5EIX-11	5464	BKR5EGP	7090	BKR5E-11	6953	.044
	V6 3.3L	Naturally Aspirated	<b>PFR5G-11</b>	<b>2647</b>	FR5AHX	95839	BKR5EIX-11	5464	BKR5EGP	7090	BKR5E-11	6953	.044
		Supercharged	<b>PFR6G-11</b>	<b>5555</b>	FR6BHX-S	95159	BKR6EIX-11	3764	BKR6EGP	7092	BKR6E-11	2756	.044
2000-99	L4 2.4L		<b>FR5AP-10</b>	<b>6371</b>	FR5AHX	95839	BKR5EIX-11	5464	BKR5EGP	7090	BKR5E-11	6953	.039
	V6 3.3L		<b>FR5AP-10</b>	<b>6371</b>	FR5AHX	95839	BKR5EIX-11	5464	BKR5EGP	7090	BKR5E-11	6953	.039
1998	L4 2.4L		<b>BKR5E-11</b>	<b>6953</b>	FR5AHX	95839	BKR5EIX-11	5464	BKR5EGP	7090	BKR5E-11	6953	.044
<b>GT-R</b>													
2017-09	V6 3.8L		<b>DILKAR8A8</b>	<b>93026</b>	LKAR8BHX	91784							.032
<b>Juke</b>													
2017	L4 1.6L	Advance	<b>DILKAR7C9H</b>	<b>91215</b>									.036
		Exclusive	<b>DILKAR7C9H</b>	<b>91215</b>									.036
		Nismo	<b>DILKAR7C9H</b>	<b>91215</b>									.036
		S	<b>DILKAR7C9H</b>	<b>91215</b>									.036
		SL	<b>DILKAR7C9H</b>	<b>91215</b>									.036
		SV	<b>DILKAR7C9H</b>	<b>91215</b>									.036
2016-15	L4 1.6L	Nismo	<b>DILKAR7C9H</b>	<b>91215</b>									.036
		S	<b>DILKAR7C9H</b>	<b>91215</b>									.036
		SL	<b>DILKAR7C9H</b>	<b>91215</b>									.036
		SV	<b>DILKAR7C9H</b>	<b>91215</b>									.036
2014-11	L4 1.6L		<b>DILKAR7C9H</b>	<b>91215</b>								.036	
<b>Maxima</b>													
2017-16	V6 3.5L		<b>DILKAR7B11</b>	<b>1406</b>	LKAR7AHX-S	92274	LKAR7BIX-11S	93501	LKAR7AGP-D	93220			.044
2014-09	V6 3.5L		<b>DILKAR7B11</b>	<b>1406</b>	LKAR7AHX-S	92274	LKAR7BIX-11S	93501	LKAR7AGP-D	93220			.044
2008-02	V6 3.5L		<b>PLFR5A-11</b>	<b>6240</b>	LFR5AHX	96355	LFR5AIX-11	4469	LFR5AGP	5018	LFR5A-11	6376	.044
2001-97	V6 3.0L		<b>PFR5G-11</b>	<b>2647</b>	FR5AHX	95839	BKR5EIX-11	5464	BKR5EGP	7090	BKR5E-11	6953	.044
1996-95	V6 3.0L		<b>PFR5G-11</b>	<b>2647</b>			BKR5EIX-11	5464	BKR5EGP	7090	BKR5E-11	6953	.044
1994-92	V6 3.0L	Eng Desg VE30DE	<b>PFR5C-11</b>	<b>2271</b>			BKR5EIX-11	5464	BKR5EGP	7090	BKR5E-11	6953	.044
		Eng Desg VG30E	<b>BKR6ES-11</b>	<b>5553</b>			BKR6EIX-11	3764	BKR6EGP	7092	BKR6E-11	2756	.044
1991-89	V6 3.0L		<b>BKR6ES-11</b>	<b>5553</b>			BKR6EIX-11	3764	BKR6EGP	7092	BKR6E-11	2756	.044
1988-85	V6 3.0L		<b>BCPR6ES-11</b>	<b>6779</b>			BCPR6EIX-11	4919	BCPR6EGP	7088	BCPR6E-11	5632	.044
<b>Micra</b>													
2017-15	L4 1.6L		<b>PLZKAR6A-11</b>	<b>5118</b>	LKAR6AHX	97292	LKAR6AIX-11	91187	LKAR6AGP	95830			.044
1991-85	L4 1.2L		<b>BPR5ES-11</b>	<b>7634</b>			BPR5EIX-11	2115	BPR5EGP	7082	BPR5EY-11	6937	.044
<b>Multi</b>													
1988-86	L4 2.0L	Dual Plug; Exhaust Side (4 Req'd)	<b>BCPR5ES-11</b>	<b>6696</b>			BCPR5EIX-11	3306	BCPR5EGP	7086	BCPR5E-11	1273	.044



Year	Cyl. L	Notes	Original Equipment		Ruthenium HX		Iridium IX		G-Power		V-Power		Gap
			Part	Stock	Part	Stock	Part	Stock	Part	Stock	Part	Stock	
<b>NISSAN (Cont'd)</b>													
Multi (Cont'd)													
1988-86		Dual Plug; Intake Side (4 Req'd)	<b>BCPR6ES-11</b>	<b>6779</b>			BCPR6EIX-11	4919	BCPR6EGP	7088	BCPR6E-11	5632	.044
Murano													
2017	V6 3.5L		DILKAR7B11	1406	LKAR7AHX-S	92274	LKAR7BIX-11S	93501	LKAR7AGP-D	93220			.044
2016	L4 2.5L		<b>DILKAR7C9H</b>	<b>91215</b>									.036
	V6 3.5L		DILKAR7B11	1406	LKAR7AHX-S	92274	LKAR7BIX-11S	93501	LKAR7AGP-D	93220			.044
2015-09	V6 3.5L		DILKAR7B11	1406	LKAR7AHX-S	92274	LKAR7BIX-11S	93501	LKAR7AGP-D	93220			.044
2007-03	V6 3.5L		<b>PLFR5A-11</b>	<b>6240</b>	LFR5AHX	96355	LFR5AIX-11	4469	LFR5AGP	5018	LFR5A-11	6376	.044
NV200													
2018-13	L4 2.0L		DILKAR6A11	9029	LKAR6AHX	97292	LKAR6AIX-11	91187	LKAR6AGP	95830			.044
NV1500													
2017-12	V6 4.0L		<b>DILFR5A11</b>	<b>93759</b>	LFR5AHX	96355	LFR5AIX-11	4469	LFR5AGP	5018			.044
NV2500													
2018	V8 5.6L		<b>DILKAR7B11</b>	<b>1406</b>	LKAR7AHX-S	92274	LKAR7BIX-11S	93501	LKAR7AGP-D	93220			.044
2017-12	V6 4.0L		<b>DILFR5A11</b>	<b>93759</b>	LFR5AHX	96355	LFR5AIX-11	4469	LFR5AGP	5018			.044
	V8 5.6L		<b>DILFR5A11</b>	<b>93759</b>	LFR5AHX	96355	LFR5AIX-11	4469	LFR5AGP	5018			.044
NV3500													
2018	V8 5.6L		<b>DILKAR7B11</b>	<b>1406</b>	LKAR7AHX-S	92274	LKAR7BIX-11S	93501	LKAR7AGP-D	93220			.044
2017-12	V6 4.0L		<b>DILFR5A11</b>	<b>93759</b>	LFR5AHX	96355	LFR5AIX-11	4469	LFR5AGP	5018			.044
	V8 5.6L		<b>DILFR5A11</b>	<b>93759</b>	LFR5AHX	96355	LFR5AIX-11	4469	LFR5AGP	5018			.044
NX													
1993-91	L4 1.6L		<b>BKR5E-11</b>	<b>6953</b>			BKR5EIX-11	5464	BKR5EGP	7090	BKR5E-11	6953	.044
	L4 2.0L		<b>PFR6B-11</b>	<b>4014</b>			BKR6EIX-11	3764	BKR6EGP	7092	BKR6E-11	2756	.044
Pathfinder													
2017-16	V6 3.5L		DILKAR7B11	1406	LKAR7AHX-S	92274	LKAR7BIX-11S	93501	LKAR7AGP-D	93220			.044
2015-14	L4 2.5L		<b>DILKAR7C9H</b>	<b>91215</b>									.036
	V6 3.5L		DILKAR7B11	1406	LKAR7AHX-S	92274	LKAR7BIX-11S	93501	LKAR7AGP-D	93220			.044
2013	V6 3.5L		DILKAR7B11	1406	LKAR7AHX-S	92274	LKAR7BIX-11S	93501	LKAR7AGP-D	93220			.044
2012-08	V6 4.0L		<b>DILFR5A11</b>	<b>93759</b>	LFR5AHX	96355	LFR5AIX-11	4469	LFR5AGP	5018			.044
	V8 5.6L		<b>DILFR5A11</b>	<b>93759</b>	LFR5AHX	96355	LFR5AIX-11	4469	LFR5AGP	5018			.044
2007	V6 4.0L		<b>DILFR5A11</b>	<b>93759</b>	LFR5AHX	96355	LFR5AIX-11	4469	LFR5AGP	5018			.044
2006-05	V6 4.0L		<b>PLFR5A-11</b>	<b>6240</b>	LFR5AHX	96355	LFR5AIX-11	4469	LFR5AGP	5018	LFR5A-11	6376	.044
2004-01	V6 3.5L		<b>PLFR5A-11</b>	<b>6240</b>	LFR5AHX	96355	LFR5AIX-11	4469	LFR5AGP	5018	LFR5A-11	6376	.044
2000-98	V6 3.3L		<b>FR5AP-10</b>	<b>6371</b>	FR5AHX	95839	BKR5EIX-11	5464	BKR5EGP	7090	BKR5E-11	6953	.039
1997	V6 3.3L		<b>BKR5E-11</b>	<b>6953</b>	FR5AHX	95839	BKR5EIX-11	5464	BKR5EGP	7090	BKR5E-11	6953	.044
1996	V6 3.3L		<b>BKR5E-11</b>	<b>6953</b>			BKR5EIX-11	5464	BKR5EGP	7090	BKR5E-11	6953	.044
1995-91	V6 3.0L		<b>BKR6EY</b>	<b>3696</b>			BKR6EIX	6418	BKR6EGP	7092	BKR6EY	3696	.032
1990	V6 3.0L	Eng Desg VG30E	<b>BKR6EY</b>	<b>3696</b>			BKR6EIX	6418	BKR6EGP	7092	BKR6EY	3696	.032
1989	V6 3.0L		<b>BCPR5ES-11</b>	<b>6696</b>			BCPR5EIX-11	3306	BCPR5EGP	7086	BCPR5E-11	1273	.044
1988-87	L4 2.4L	Dual Plug; Exhaust Side (4 Req'd)	<b>BPR5ES</b>	<b>7734</b>			BPR5EIX	6597	BPR5EGP	7082	BPR5EY	1233	.032
		Dual Plug; Intake Side (4 Req'd)	<b>BPR6ES</b>	<b>7131</b>			BPR6EIX	6637	BPR6EGP	7084	BPR6EY	6427	.032
	V6 3.0L		<b>BCPR5ES-11</b>	<b>6696</b>			BCPR5EIX-11	3306	BCPR5EGP	7086	BCPR5E-11	1273	.044
Pathfinder Armada													
2004	V8 5.6L		<b>PLFR5A-11</b>	<b>6240</b>	LFR5AHX	96355	LFR5AIX-11	4469	LFR5AGP	5018	LFR5A-11	6376	.044
Pickup													
1997-96	L4 2.4L		<b>ZFR5E-11</b>	<b>4435</b>			ZFR5FIX-11	2477	ZFR5EGP	7096	ZFR5E-11	4435	.044
1995	L4 2.4L		<b>ZFR5E-11</b>	<b>4435</b>			ZFR5FIX-11	2477	ZFR5EGP	7096	ZFR5E-11	4435	.044
	V6 3.0L		<b>BKR6EY</b>	<b>3696</b>			BKR6EIX	6418	BKR6EGP	7092	BKR6EY	3696	.032
Pulsar NX													
1990	L4 1.6L		<b>BCPR5ES-11</b>	<b>6696</b>			BCPR5EIX-11	3306	BCPR5EGP	7086	BCPR5E-11	1273	.044
1989	L4 1.6L		<b>BCPR5ES-11</b>	<b>6696</b>			BCPR5EIX-11	3306	BCPR5EGP	7086	BCPR5E-11	1273	.044
	L4 1.8L		<b>PFR6A-11</b>	<b>4045</b>			BCPR6EIX-11	4919	BCPR6EGP	7088	BCPR6E-11	5632	.044
1988	L4 1.6L		<b>BPR5ES-11</b>	<b>7634</b>			BPR5EIX-11	2115	BPR5EGP	7082	BPR5EY-11	6937	.044
	L4 1.8L		<b>PFR6A-11</b>	<b>4045</b>			BCPR6EIX-11	4919	BCPR6EGP	7088	BCPR6E-11	5632	.044
1987	L4 1.6L	Eng Desg CA16DE	<b>PFR6A-11</b>	<b>4045</b>			BCPR6EIX-11	4919	BCPR6EGP	7088	BCPR6E-11	5632	.044
		Eng Desg E16l	<b>BPR5ES-11</b>	<b>7634</b>			BPR5EIX-11	2115	BPR5EGP	7082	BPR5EY-11	6937	.044

**Bold denotes NGK OE Manufacturer and/or OE Service Part**  
NOT BOLD denotes OE Equivalent Part

**Le texte en gras désigne une pièce d'équipement originale du manufacturier NGK et/ou pièce d'équipement originale de service**  
Le texte non en gras désigne une pièce d'équipement originale équivalente

Note: Due to different operating or engine conditions, alternate heat range plugs may be required.

Note: En raison de différences au niveau du fonctionnement ou des conditions du moteur, d'autres types de bougies avec variation de chaleur peuvent être nécessaires



Year	Cyl. L	Notes	Original Equipment		Ruthenium HX		Iridium IX		G-Power		V-Power		Gap
			Part	Stock	Part	Stock	Part	Stock	Part	Stock	Part	Stock	
<b>NISSAN (Cont'd)</b>													
<b>Pulsar NX (Cont'd)</b>													
1986-85	L4 1.6L		<b>BPR5ES-11</b>	<b>7634</b>			BPR5EIX-11	2115	BPR5EGP	7082	BPR5EY-11	6937	.044
<b>Quest</b>													
2017-11	V6 3.5L		DILKAR7B11	1406	LKAR7AHX-S	92274	LKAR7BIX-11S	93501	LKAR7AGP-D	93220			.044
2009-04	V6 3.5L		<b>PLFR5A-11</b>	<b>6240</b>	LFR5AHX	96355	LFR5AIX-11	4469	LFR5AGP	5018	LFR5A-11	6376	.044
2002-01	V6 3.3L		<b>PFR5G-11</b>	<b>2647</b>	FR5AHX	95839	BKR5EIX-11	5464	BKR5EGP	7090	BKR5E-11	6953	.044
2000-99	V6 3.3L		<b>FR5AP-10</b>	<b>6371</b>	FR5AHX	95839	BKR5EIX-11	5464	BKR5EGP	7090	BKR5E-11	6953	.039
1998-97	V6 3.0L		<b>BKR5EY</b>	<b>7390</b>	FR5AHX	95839	BKR5EIX	6341	BKR5EGP	7090	BKR5EY	7390	.032
1996-93	V6 3.0L		<b>BKR5EY</b>	<b>7390</b>			BKR5EIX	6341	BKR5EGP	7090	BKR5EY	7390	.032
<b>Rogue</b>													
2017-16	L4 2.5L		DF6H-11A	94702	LKAR6AHX	97292							.044
2015-14	L4 2.5L	New Body Style	DF6H-11A	94702	LKAR6AHX	97292							.044
2013-08	L4 2.5L		<b>DILKAR6A11</b>	<b>9029</b>	LKAR6AHX	97292	LKAR6AIX-11	91187	LKAR6AGP	95830			.044
<b>Rogue Select</b>													
2015-14	L4 2.5L	Carryover Body Style	<b>DILKAR6A11</b>	<b>9029</b>	LKAR6AHX	97292	LKAR6AIX-11	91187	LKAR6AGP	95830			.044
<b>Sentra</b>													
2017-13	L4 1.8L	Calif. Emissions	<b>DILKAR6A11</b>	<b>9029</b>	LKAR6AHX	97292	LKAR6AIX-11	91187	LKAR6AGP	95830			.044
		Federal Emissions	<b>PLZKAR6A-11</b>	<b>5118</b>	LKAR6AHX	97292	LKAR6AIX-11	91187	LKAR6AGP	95830			.044
2012-11	L4 2.0L		DILKAR6A11	9029	LKAR6AHX	97292	LKAR6AIX-11	91187	LKAR6AGP	95830			.044
	L4 2.5L		<b>DILKAR6A11</b>	<b>9029</b>	LKAR6AHX	97292	LKAR6AIX-11	91187	LKAR6AGP	95830			.044
2010-07	L4 2.0L		<b>PLZKAR6A-11</b>	<b>5118</b>	LKAR6AHX	97292	LKAR6AIX-11	91187	LKAR6AGP	95830			.044
	L4 2.5L		<b>DILKAR6A11</b>	<b>9029</b>	LKAR6AHX	97292	LKAR6AIX-11	91187	LKAR6AGP	95830			.044
2006-02	L4 1.8L		<b>PLFR5A-11</b>	<b>6240</b>	LFR5AHX	96355	LFR5AIX-11	4469	LFR5AGP	5018	LFR5A-11	6376	.044
	L4 2.5L		<b>PLFR5A-11</b>	<b>6240</b>	LFR5AHX	96355	LFR5AIX-11	4469	LFR5AGP	5018	LFR5A-11	6376	.044
2001-00	L4 1.8L		<b>PLFR5A-11</b>	<b>6240</b>	LFR5AHX	96355	LFR5AIX-11	4469	LFR5AGP	5018	LFR5A-11	6376	.044
	L4 2.0L		<b>PFR5G-11</b>	<b>2647</b>	FR5AHX	95839	BKR5EIX-11	5464	BKR5EGP	7090	BKR5E-11	6953	.044
1999-98	L4 1.6L		<b>BKR5E-11</b>	<b>6953</b>	FR5AHX	95839	BKR5EIX-11	5464	BKR5EGP	7090	BKR5E-11	6953	.044
	L4 2.0L		<b>PFR6B-11</b>	<b>4014</b>	FR6AHX-S	94279	BKR6EIX-11	3764	BKR6EGP	7092	BKR6E-11	2756	.044
1997	L4 1.6L		<b>BKR5E-11</b>	<b>6953</b>	FR5AHX	95839	BKR5EIX-11	5464	BKR5EGP	7090	BKR5E-11	6953	.044
1996-95	L4 1.6L		<b>BKR5E-11</b>	<b>6953</b>			BKR5EIX-11	5464	BKR5EGP	7090	BKR5E-11	6953	.044
1994-93	L4 1.6L		<b>BKR5E-11</b>	<b>6953</b>			BKR5EIX-11	5464	BKR5EGP	7090	BKR5E-11	6953	.044
	L4 2.0L		<b>PFR6B-11</b>	<b>4014</b>			BKR6EIX-11	3764	BKR6EGP	7092	BKR6E-11	2756	.044
1992	L4 1.6L	Vin E	<b>BKR5E-11</b>	<b>6953</b>			BKR5EIX-11	5464	BKR5EGP	7090	BKR5E-11	6953	.044
		Vin P	<b>BKR5E-11</b>	<b>6953</b>			BKR5EIX-11	5464	BKR5EGP	7090	BKR5E-11	6953	.044
1991	L4 2.0L		<b>PFR6B-11</b>	<b>4014</b>			BKR6EIX-11	3764	BKR6EGP	7092	BKR6E-11	2756	.044
	L4 1.6L		<b>BKR5E-11</b>	<b>6953</b>			BKR5EIX-11	5464	BKR5EGP	7090	BKR5E-11	6953	.044
1990-89	L4 1.6L		<b>BCPR5ES-11</b>	<b>6696</b>			BCPR5EIX-11	3306	BCPR5EGP	7086	BCPR5E-11	1273	.044
	L4 1.6L		<b>BPR6ES-11</b>	<b>7133</b>			BPR6EIX-11	3903	BPR6EGP	7084	BPR6EY-11	6261	.044
1987	L4 1.6L		<b>BPR6ES-11</b>	<b>7133</b>			BPR6EIX-11	3903	BPR6EGP	7084	BPR6EY-11	6261	.044
	L4 1.7L	DIESEL	<b>Y-117RS</b>	<b>2930</b>									
1986-85	L4 1.6L		<b>BPR5ES-11</b>	<b>7634</b>			BPR5EIX-11	2115	BPR5EGP	7082	BPR5EY-11	6937	.044
	L4 1.7L	DIESEL	<b>Y-117RS</b>	<b>2930</b>									
<b>Stanza</b>													
1992-90	L4 2.4L		<b>ZFR5E-11</b>	<b>4435</b>			ZFR5FIX-11	2477	ZFR5EGP	7096	ZFR5E-11	4435	.044
1989-85	L4 2.0L	Dual Plug; Exhaust Side (4 Req'd)	<b>BCPR5ES-11</b>	<b>6696</b>			BCPR5EIX-11	3306	BCPR5EGP	7086	BCPR5E-11	1273	.044
		Dual Plug; Intake Side (4 Req'd)	<b>BCPR6ES-11</b>	<b>6779</b>			BCPR6EIX-11	4919	BCPR6EGP	7088	BCPR6E-11	5632	.044
<b>Titan</b>													
2017	V8 5.6L		<b>DILKAR7B11</b>	<b>1406</b>	LKAR7AHX-S	92274	LKAR7BIX-11S	93501	LKAR7AGP-D	93220			.044
2015-07	V8 5.6L	FLEX	<b>DILFR5A-11D</b>	<b>98376</b>	LFR5AHX	96355	LFR5AIX-11	4469	LFR5AGP	5018			.044
		GAS	<b>DILFR5A11</b>	<b>93759</b>	LFR5AHX	96355	LFR5AIX-11	4469	LFR5AGP	5018			.044
2006-04	V8 5.6L		<b>PLFR5A-11</b>	<b>6240</b>	LFR5AHX	96355	LFR5AIX-11	4469	LFR5AGP	5018	LFR5A-11	6376	.044
<b>Titan XD</b>													
2017-16	V8 5.6L		<b>DILKAR7B11</b>	<b>1406</b>	LKAR7AHX-S	92274	LKAR7BIX-11S	93501	LKAR7AGP-D	93220			.044
<b>Van</b>													
1988-87	L4 2.4L	Dual Plug; Exhaust Side (4 Req'd)	<b>BPR5ES</b>	<b>7734</b>			BPR5EIX	6597	BPR5EGP	7082	BPR5EY	1233	.032



Year	Cyl. L	Notes	Original Equipment		Ruthenium HX		Iridium IX		G-Power		V-Power		Gap
			Part	Stock	Part	Stock	Part	Stock	Part	Stock	Part	Stock	
<b>NISSAN (Cont'd)</b>													
<b>Van (Cont'd)</b>													
1988-87		Dual Plug; Intake Side (4 Req'd)	<b>BPR6ES</b>	<b>7131</b>			BPR6EIX	6637	BPR6EGP	7084	BPR6EY	6427	.032
<b>Versa</b>													
2017-13	L4 1.6L		PLZKAR6A-11	5118	LKAR6AHX	97292	LKAR6AIX-11	91187	LKAR6AGP	95830			.044
2012	L4 1.6L		PLZKAR6A-11	5118	LKAR6AHX	97292	LKAR6AIX-11	91187	LKAR6AGP	95830			.044
	L4 1.8L		DILKAR6A11	9029	LKAR6AHX	97292	LKAR6AIX-11	91187	LKAR6AGP	95830			.044
2011-09	L4 1.6L		<b>DILKAR6A11</b>	<b>9029</b>	LKAR6AHX	97292	LKAR6AIX-11	91187	LKAR6AGP	95830			.044
	L4 1.8L		DILKAR6A11	9029	LKAR6AHX	97292	LKAR6AIX-11	91187	LKAR6AGP	95830			.044
2008-07	L4 1.8L		DILKAR6A11	9029	LKAR6AHX	97292	LKAR6AIX-11	91187	LKAR6AGP	95830			.044
<b>Versa Note</b>													
2017-14	L4 1.6L		PLZKAR6A-11	5118	LKAR6AHX	97292	LKAR6AIX-11	91187	LKAR6AGP	95830			.044
<b>Xterra</b>													
2015-07	V6 4.0L		<b>DILFR5A11</b>	<b>93759</b>	LF5A5HX	96355	LF5A5IX-11	4469	LF5A5GP	5018			.044
2006-05	V6 4.0L		<b>PLFR5A-11</b>	<b>6240</b>	LF5A5HX	96355	LF5A5IX-11	4469	LF5A5GP	5018	LF5A-11	6376	.044
2004-02	L4 2.4L		<b>PFR5G-11</b>	<b>2647</b>	FR5AHX	95839	BKR5EIX-11	5464	BKR5EGP	7090	BKR5E-11	6953	.044
	V6 3.3L	Naturally Aspirated	<b>PFR5G-11</b>	<b>2647</b>	FR5AHX	95839	BKR5EIX-11	5464	BKR5EGP	7090	BKR5E-11	6953	.044
		Supercharged	<b>PFR6G-11</b>	<b>5555</b>	FR6BHX-S	95159	BKR6EIX-11	3764	BKR6EGP	7092	BKR6E-11	2756	.044
2001	L4 2.4L		<b>PFR5G-11</b>	<b>2647</b>	FR5AHX	95839	BKR5EIX-11	5464	BKR5EGP	7090	BKR5E-11	6953	.044
	V6 3.3L		<b>PFR5G-11</b>	<b>2647</b>	FR5AHX	95839	BKR5EIX-11	5464	BKR5EGP	7090	BKR5E-11	6953	.044
2000	L4 2.4L		<b>FR5AP-10</b>	<b>6371</b>	FR5AHX	95839	BKR5EIX-11	5464	BKR5EGP	7090	BKR5E-11	6953	.039
	V6 3.3L		<b>FR5AP-10</b>	<b>6371</b>	FR5AHX	95839	BKR5EIX-11	5464	BKR5EGP	7090	BKR5E-11	6953	.039
<b>X-Trail</b>													
2006-05	L4 2.5L		<b>PLFR5A-11</b>	<b>6240</b>	LF5A5HX	96355	LF5A5IX-11	4469	LF5A5GP	5018	LF5A-11	6376	.044
<b>OLDSMOBILE</b>													
<b>88</b>													
1999	V6 3.8L		ITR4A15	5599	TR4BHX	97100	TR55IX	7164	TR55GP	3403	TR55	3951	.060
1998	V6 3.8L		<b>ITR4A15</b>	<b>5599</b>	TR4BHX	97100	TR55IX	7164	TR55GP	3403	TR55	3951	.060
1997	V6 3.8L		ITR4A15	5599	TR4BHX	97100	TR55IX	7164	TR55GP	3403	TR55	3951	.060
1996-94	V6 3.8L		ITR4A15	5599			TR55IX	7164	TR55GP	3403	TR55	3951	.060
1993-92	V6 3.8L		TR55	3951			TR55IX	7164	TR55GP	3403	TR55	3951	.060
<b>98</b>													
1996-94	V6 3.8L		ITR4A15	5599			TR55IX	7164	TR55GP	3403	TR55	3951	.060
1993-88	V6 3.8L		TR55	3951			TR55IX	7164	TR55GP	3403	TR55	3951	.060
1987-86	V6 3.8L		TR5	2238			TR5IX	7397	TR5GP	3186	TR5	2238	.045
1985	V6 3.0L		UR45	6945			UR45IX	7559	UR45GP	3207	UR45	6945	.060
	V6 3.8L		UR45	6945			UR45IX	7559	UR45GP	3207	UR45	6945	.080
<b>Achieva</b>													
1998-97	L4 2.4L		PZTR5A-15	7862	TR5AHX	94567	TR55IX	7164	TR55GP	3403	TR55	3951	.060
	V6 3.1L		ITR4A15	5599	TR4BHX	97100	TR55IX	7164	TR55GP	3403	TR55	3951	.060
1996	L4 2.4L		PZTR5A-15	7862			TR55IX	7164	TR55GP	3403	TR55	3951	.060
	V6 3.1L		ITR4A15	5599			TR55IX	7164	TR55GP	3403	TR55	3951	.060
1995	L4 2.3L		PZTR5A-15	7862			TR55IX	7164	TR55GP	3403	TR55	3951	.060
	V6 3.1L		ITR4A15	5599			TR55IX	7164	TR55GP	3403	TR55	3951	.060
1994	L4 2.3L	Vin 3	FR4	5155			BKR4EIX	5693	FR4GP	2685	FR4	5155	.035
		Vin A	BKR5E	7938			BKR5EIX	6341	BKR5EGP	7090	BKR5E	7938	.035
		Vin D	FR4	5155			BKR4EIX	5693	FR4GP	2685	FR4	5155	.035
	V6 3.1L		ITR4A15	5599			TR55IX	7164	TR55GP	3403	TR55	3951	.060
1993-92	L4 2.3L	Vin 3	FR4	5155			BKR4EIX	5693	FR4GP	2685	FR4	5155	.035
		Vin A	BKR5E	7938			BKR5EIX	6341	BKR5EGP	7090	BKR5E	7938	.035
		Vin D	FR4	5155			BKR4EIX	5693	FR4GP	2685	FR4	5155	.035
	V6 3.3L		TR55	3951			TR55IX	7164	TR55GP	3403	TR55	3951	.060
<b>Alero</b>													
2004-02	L4 2.2L		<b>ILTR5C11</b>	<b>5581</b>			LTR5IX-11	4344	LTR5GP	5019			.044
	V6 3.4L		<b>ITR4A15</b>	<b>5599</b>	TR4BHX	97100	TR55IX	7164	TR55GP	3403	TR55	3951	.060
2001-99	L4 2.4L		PTR5F-11	6579	TR5AHX	94567	TR55IX	7164	TR55GP	3403	TR55	3951	.050
	V6 3.4L		ITR4A15	5599	TR4BHX	97100	TR55IX	7164	TR55GP	3403	TR55	3951	.060

**Bold denotes NGK OE Manufacturer and/or OE Service Part**  
NOT BOLD denotes OE Equivalent Part

Note: Due to different operating or engine conditions, alternate heat range plugs may be required.

**Le texte en gras désigne une pièce d'équipement originale du manufacturier NGK et/ou pièce d'équipement originale de service**  
Le texte non en gras désigne une pièce d'équipement originale équivalente

Note: En raison de différences au niveau du fonctionnement ou des conditions du moteur, d'autres types de bougies avec variation de chaleur peuvent être nécessaires



Year	Cyl. L	Notes	Original Equipment		Ruthenium HX		Iridium IX		G-Power		V-Power		Gap
			Part	Stock	Part	Stock	Part	Stock	Part	Stock	Part	Stock	
<b>OLDSMOBILE (Cont'd)</b>													
Aurora													
2003	V8 4.0L		PTR5F-11	6579	TR5AHX	94567	TR55IX	7164	TR55GP	3403	TR55	3951	.050
2002-01	V6 3.5L		<b>PTR5C-13</b>	<b>7740</b>	TR5AHX	94567	TR55IX	7164	TR55GP	3403	TR55	3951	.052
	V8 4.0L		PTR5F-11	6579	TR5AHX	94567	TR55IX	7164	TR55GP	3403	TR55	3951	.050
1999-95	V8 4.0L		PTR5F-11	6579			TR55IX	7164	TR55GP	3403	TR55	3951	.050
Bravada													
2004-02	L6 4.2L		<b>ILTR5E11</b>	<b>91418</b>	LTR5AHX	90220	LTR5IX-11	4344	LTR5GP	5019			.044
2001-97	V6 4.3L		PZTR5A-15	7862	TR5AHX	94567	TR55IX	7164	TR55GP	3403	TR55	3951	.060
1996	V6 4.3L		PZTR5A-15	7862			TR55IX	7164	TR55GP	3403	TR55	3951	.060
1994	V6 4.3L		UR5	2771			UR5IX	7177	UR5GP	3547	UR5	2771	.045
1993-91	V6 4.3L		UR5	2771			UR5IX	7177	UR5GP	3547	UR5	2771	.035
Calais													
1987	L4 2.3L		FR4	5155			BKR4EIX	5693	FR4GP	2685	FR4	5155	.035
	L4 2.5L		UR55	2248			UR55IX	7272			UR55	2248	.060
	V6 3.0L		TR5	2238			TR5IX	7397	TR5GP	3186	TR5	2238	.045
1986	L4 2.5L		UR55	2248			UR55IX	7272			UR55	2248	.060
	V6 3.0L		TR5	2238			TR5IX	7397	TR5GP	3186	TR5	2238	.045
1985	L4 2.5L		UR55	2248			UR55IX	7272			UR55	2248	.060
	V6 3.0L		TR5	2238			TR5IX	7397	TR5GP	3186	TR5	2238	.040
Custom Cruiser													
1992	V8 5.0L		UR4	6630			UR4IX	7401	UR4GP	2869	UR4	6630	.035
	V8 5.7L		UR5	2771			UR5IX	7177	UR5GP	3547	UR5	2771	.035
1991	V8 5.0L		UR4	6630			UR4IX	7401	UR4GP	2869	UR4	6630	.035
1990-85	V8 5.0L		FR45	3686					FR45GP	3072	FR45	3686	.060
Cutlass													
1999-97	V6 3.1L		ITR4A15	5599	TR4BHX	97100	TR55IX	7164	TR55GP	3403	TR55	3951	.060
1987-85	V8 5.0L		UR4	6630			UR4IX	7401	UR4GP	2869	UR4	6630	.045
Cutlass Calais													
1991-89	L4 2.3L		FR4	5155			BKR4EIX	5693	FR4GP	2685	FR4	5155	.035
	L4 2.5L		UR55	2248			UR55IX	7272			UR55	2248	.060
	V6 3.3L		TR55	3951			TR55IX	7164	TR55GP	3403	TR55	3951	.060
1988	L4 2.3L		FR4	5155			BKR4EIX	5693	FR4GP	2685	FR4	5155	.035
	L4 2.5L		UR55	2248			UR55IX	7272			UR55	2248	.060
	V6 3.0L		TR5	2238			TR5IX	7397	TR5GP	3186	TR5	2238	.045
Cutlass Ciera													
1996-94	L4 2.2L		PZTR5A-15	7862			TR55-11X	7316	TR55-1GP	7159	TR55-1	2683	.060
	V6 3.1L		ITR4A15	5599			TR55IX	7164	TR55GP	3403	TR55	3951	.060
1993	L4 2.2L		TR4	3754			TR4IX	7300	TR4GP	2815	TR4	3754	.045
	V6 3.3L		TR55	3951			TR55IX	7164	TR55GP	3403	TR55	3951	.060
1992-90	L4 2.5L		UR55	2248			UR55IX	7272			UR55	2248	.060
	V6 3.3L		TR55	3951			TR55IX	7164	TR55GP	3403	TR55	3951	.060
1989	L4 2.5L		UR55	2248			UR55IX	7272			UR55	2248	.060
	V6 2.8L		TR4	3754			TR4IX	7300	TR4GP	2815	TR4	3754	.045
	V6 3.3L		TR55	3951			TR55IX	7164	TR55GP	3403	TR55	3951	.060
1988-87	L4 2.5L		UR55	2248			UR55IX	7272			UR55	2248	.060
	V6 2.8L		TR4	3754			TR4IX	7300	TR4GP	2815	TR4	3754	.045
	V6 3.8L		TR5	2238			TR5IX	7397	TR5GP	3186	TR5	2238	.045
1986	L4 2.5L		UR55	2248			UR55IX	7272			UR55	2248	.060
	V6 2.8L		UR5	2771			UR5IX	7177	UR5GP	3547	UR5	2771	.045
	V6 3.8L		TR5	2238			TR5IX	7397	TR5GP	3186	TR5	2238	.045
1985	L4 2.5L		UR55	2248			UR55IX	7272			UR55	2248	.060
	V6 2.8L		UR5	2771			UR5IX	7177	UR5GP	3547	UR5	2771	.045
	V6 3.0L		UR45	6945			UR45IX	7559	UR45GP	3207	UR45	6945	.060
	V6 3.8L		UR45	6945			UR45IX	7559	UR45GP	3207	UR45	6945	.080
Cutlass Cruiser													
1994	V6 3.1L		PZTR5A-15	7862			TR55IX	7164	TR55GP	3403	TR55	3951	.060
1993-91	V6 3.3L		TR55	3951			TR55IX	7164	TR55GP	3403	TR55	3951	.060
1990	L4 2.5L		UR55	2248			UR55IX	7272			UR55	2248	.060

210 Bold denotes NGK OE Manufacturer and/or OE Service Part  
NOT BOLD denotes OE Equivalent Part

El texto marcado en negrita indica que NGK es el proveedor para Equipo Original y/o Repuesto de Equipo Original.  
El texto sin negritas marca que es un equivalente al Equipo Original.

Note: Due to different operating or engine conditions, alternate heat range plugs may be required.

Nota: Debido a las diferentes condiciones de operación del motor, se puede requerir un rango térmico alterno.





Year	Cyl. L	Notes	Original Equipment		Ruthenium HX		Iridium IX		G-Power		V-Power		Gap
			Part	Stock	Part	Stock	Part	Stock	Part	Stock	Part	Stock	
<b>OLDSMOBILE (Cont'd)</b>													
<b>Cutlass Cruiser (Cont'd)</b>													
1990	V6 3.3L		TR55	3951			TR55IX	7164	TR55GP	3403	TR55	3951	.060
1989	L4 2.5L		UR55	2248			UR55IX	7272			UR55	2248	.060
	V6 2.8L		TR4	3754			TR4IX	7300	TR4GP	2815	TR4	3754	.045
	V6 3.3L		TR55	3951			TR55IX	7164	TR55GP	3403	TR55	3951	.060
1988-87	L4 2.5L		UR55	2248			UR55IX	7272			UR55	2248	.060
	V6 2.8L		TR4	3754			TR4IX	7300	TR4GP	2815	TR4	3754	.045
	V6 3.8L		TR5	2238			TR5IX	7397	TR5GP	3186	TR5	2238	.045
<b>Cutlass Salon</b>													
1987-86	V6 3.8L		UR45	6945			UR45IX	7559	UR45GP	3207	UR45	6945	.060
	V8 5.0L		FR45	3686					FR45GP	3072	FR45	3686	.060
1985	V6 3.8L		UR45	6945			UR45IX	7559	UR45GP	3207	UR45	6945	.060
	V8 5.0L	Vin 9	XR45	4536			XR45IX	7293			XR45	4536	.060
		Vin Y	FR45	3686					FR45GP	3072	FR45	3686	.060
<b>Cutlass Supreme</b>													
1997	V6 3.1L		ITR4A15	5599	TR4BHX	97100	TR55IX	7164	TR55GP	3403	TR55	3951	.060
1996	V6 3.1L		ITR4A15	5599			TR55IX	7164	TR55GP	3403	TR55	3951	.060
	V6 3.4L		ITR4A15	5599			TR55IX	7164	TR55GP	3403	TR55	3951	.060
1995-94	V6 3.1L		ITR4A15	5599			TR55IX	7164	TR55GP	3403	TR55	3951	.060
	V6 3.4L		PTR5F-11	6579			TR5IX	7397	TR5GP	3186	TR5	2238	.045
1993	V6 3.1L	Vin M	TR55	3951			TR55IX	7164	TR55GP	3403	TR55	3951	.060
		Vin T	TR4	3754			TR4IX	7300	TR4GP	2815	TR4	3754	.045
	V6 3.4L		TR5	2238			TR5IX	7397	TR5GP	3186	TR5	2238	.045
1992	V6 3.1L		TR4	3754			TR4IX	7300	TR4GP	2815	TR4	3754	.045
	V6 3.4L		TR5	2238			TR5IX	7397	TR5GP	3186	TR5	2238	.045
1991	L4 2.3L		FR4	5155			BKR4EIX	5693	FR4GP	2685	FR4	5155	.035
	V6 3.1L		TR4	3754			TR4IX	7300	TR4GP	2815	TR4	3754	.045
	V6 3.4L		TR5	2238			TR5IX	7397	TR5GP	3186	TR5	2238	.045
1990	L4 2.3L		FR4	5155			BKR4EIX	5693	FR4GP	2685	FR4	5155	.035
	V6 3.1L		TR4	3754			TR4IX	7300	TR4GP	2815	TR4	3754	.045
1989	V6 2.8L		TR4	3754			TR4IX	7300	TR4GP	2815	TR4	3754	.045
	V6 3.1L		TR4	3754			TR4IX	7300	TR4GP	2815	TR4	3754	.045
1988	V6 2.8L		TR4	3754			TR4IX	7300	TR4GP	2815	TR4	3754	.045
	V8 5.0L		FR45	3686					FR45GP	3072	FR45	3686	.060
1987	V6 3.8L		UR45	6945			UR45IX	7559	UR45GP	3207	UR45	6945	.060
	V8 5.0L	Vin 9	FR45	3686					FR45GP	3072	FR45	3686	.060
		Vin Y	FR45	3686					FR45GP	3072	FR45	3686	.060
1986-85	V6 3.8L		UR45	6945			UR45IX	7559	UR45GP	3207	UR45	6945	.060
	V8 5.0L	Vin Y	FR45	3686					FR45GP	3072	FR45	3686	.060
<b>Delta 88</b>													
1991-89	V6 3.8L		TR55	3951			TR55IX	7164	TR55GP	3403	TR55	3951	.060
1988	V6 3.8L	Vin 3	TR5	2238			TR5IX	7397	TR5GP	3186	TR5	2238	.045
		Vin C	TR55	3951			TR55IX	7164	TR55GP	3403	TR55	3951	.060
1987	V6 3.8L		TR5	2238			TR5IX	7397	TR5GP	3186	TR5	2238	.045
1986	V6 3.0L		TR5	2238			TR5IX	7397	TR5GP	3186	TR5	2238	.045
	V6 3.8L		TR5	2238			TR5IX	7397	TR5GP	3186	TR5	2238	.045
1985	V6 3.8L		UR45	6945			UR45IX	7559	UR45GP	3207	UR45	6945	.060
	V8 5.0L		FR45	3686					FR45GP	3072	FR45	3686	.060
<b>Firenza</b>													
1988	L4 2.0L	Vin 1	TR4	3754			TR4IX	7300	TR4GP	2815	TR4	3754	.035
		Vin K	GR45	4268					GR45GP	3142	GR45	4268	.060
1987	L4 2.0L	Vin 1	TR4	3754			TR4IX	7300	TR4GP	2815	TR4	3754	.035
		Vin K	GR45	4268					GR45GP	3142	GR45	4268	.060
1986-85	V6 2.8L		TR4	3754			TR4IX	7300	TR4GP	2815	TR4	3754	.045
	L4 1.8L		GR4	2635			GR4IX	97382	GR4GP	2763	GR4	2635	.035
	L4 2.0L		UR5	2771			UR5IX	7177	UR5GP	3547	UR5	2771	.035
	V6 2.8L		UR5	2771			UR5IX	7177	UR5GP	3547	UR5	2771	.045

**Bold denotes NGK OE Manufacturer and/or OE Service Part**  
NOT BOLD denotes OE Equivalent Part

**Le texte en gras désigne une pièce d'équipement originale du manufacturier NGK et/ou pièce d'équipement originale de service**  
Le texte non en gras désigne une pièce d'équipement originale équivalente

Note: Due to different operating or engine conditions, alternate heat range plugs may be required.

Note: En raison de différences au niveau du fonctionnement ou des conditions du moteur, d'autres types de bougies avec variation de chaleur peuvent être nécessaires



Year	Cyl. L	Notes	Original Equipment		Ruthenium HX		Iridium IX		G-Power		V-Power		Gap
			Part	Stock	Part	Stock	Part	Stock	Part	Stock	Part	Stock	
<b>OLDSMOBILE (Cont'd)</b>													
<b>Intrigue</b>													
2002-00	V6 3.5L		<b>PTR5C-13</b>	<b>7740</b>	TR5AHX	94567	TR55IX	7164	TR55GP	3403	TR55	3951	.052
1999	V6 3.5L		<b>PTR5C-13</b>	<b>7740</b>	TR5AHX	94567	TR55IX	7164	TR55GP	3403	TR55	3951	.052
	V6 3.8L		ITR4A15	5599	TR4BHX	97100	TR55IX	7164	TR55GP	3403	TR55	3951	.060
1998	V6 3.8L		ITR4A15	5599	TR4BHX	97100	TR55IX	7164	TR55GP	3403	TR55	3951	.060
<b>LSS</b>													
1999-98	V6 3.8L	Naturally Aspirated	ITR4A15	5599	TR4BHX	97100	TR55IX	7164	TR55GP	3403	TR55	3951	.060
		Supercharged	<b>ITR4A15</b>	<b>5599</b>	TR4BHX	97100	TR55IX	7164	TR55GP	3403	TR55	3951	.060
1997	V6 3.8L		ITR4A15	5599	TR4BHX	97100	TR55IX	7164	TR55GP	3403	TR55	3951	.060
1996	V6 3.8L		ITR4A15	5599			TR55IX	7164	TR55GP	3403	TR55	3951	.060
<b>Regency</b>													
1998-97	V6 3.8L		ITR4A15	5599	TR4BHX	97100	TR55IX	7164	TR55GP	3403	TR55	3951	.060
<b>Silhouette</b>													
2004-02	V6 3.4L		<b>ITR4A15</b>	<b>5599</b>	TR4BHX	97100	TR55IX	7164	TR55GP	3403	TR55	3951	.060
2001-97	V6 3.4L		ITR4A15	5599	TR4BHX	97100	TR55IX	7164	TR55GP	3403	TR55	3951	.060
1996	V6 3.4L		ITR4A15	5599			TR55IX	7164	TR55GP	3403	TR55	3951	.060
1995	V6 3.8L		ITR4A15	5599			TR55IX	7164	TR55GP	3403	TR55	3951	.060
1994	V6 3.1L		UR5	2771			UR5IX	7177	UR5GP	3547	UR5	2771	.045
	V6 3.8L		ITR4A15	5599			TR55IX	7164	TR55GP	3403	TR55	3951	.060
1993-92	V6 3.1L		UR5	2771			UR5IX	7177	UR5GP	3547	UR5	2771	.045
	V6 3.8L		TR55	3951			TR55IX	7164	TR55GP	3403	TR55	3951	.060
1991-90	V6 3.1L		UR5	2771			UR5IX	7177	UR5GP	3547	UR5	2771	.045
<b>Toronado</b>													
1992-88	V6 3.8L		TR55	3951			TR55IX	7164	TR55GP	3403	TR55	3951	.060
1987-86	V6 3.8L		TR5	2238			TR5IX	7397	TR5GP	3186	TR5	2238	.045
1985	V8 5.0L		FR45	3686					FR45GP	3072	FR45	3686	.060
<b>PANOZ</b>													
<b>AIV Roadster</b>													
2000-99	V8 4.6L		PTR5F-11	6579	TR5AHX	94567	TR5IX	7397	TR5GP	3186	TR5	2238	.030
<b>Esperante</b>													
2005	V8 4.6L	Naturally Aspirated	PTR5D-10	3784	TR5AHX	94567	TR5IX	7397	TR5GP	3186	TR5	2238	.030
		Supercharged	PTR5F-11	6579			TR5IX	7397	TR5GP	3186	TR5	2238	.030
2004	V8 4.6L		PTR5D-10	3784			TR5IX	7397	TR5GP	3186	TR5	2238	.030
2003	V8 4.6L		PTR5D-10	3784	TR5AHX	94567	TR5IX	7397	TR5GP	3186	TR5	2238	.030
2002-01	V8 4.6L		PTR5F-11	6579	TR5AHX	94567	TR5IX	7397	TR5GP	3186	TR5	2238	.030
<b>PEUGEOT</b>													
<b>405</b>													
1991-89	L4 1.9L	DOHC	BCPR6ES-11	6779			BCPR6EIX-11	4919	BCPR6EGP	7088	BCPR6E-11	5632	.048
		SOHC	BKR5ES	2460			BKR5EIX	6341	BKR5EGP	7090	BKR5E	7938	.028
<b>505</b>													
1991-90	L4 2.2L	Naturally Aspirated	TR5	2238			TR5IX	7397	TR5GP	3186	TR5	2238	.035
		Turbo	BPR6ES	7131			BPR6EIX	6637	BPR6EGP	7084	BPR6EY	6427	.032
1989	L4 2.2L	Naturally Aspirated	TR5	2238			TR5IX	7397	TR5GP	3186	TR5	2238	.035
		Turbo	BP6ET	1263									.032
	V6 2.8L		TR5	2238			TR5IX	7397	TR5GP	3186	TR5	2238	.025
1988	L4 2.2L	Naturally Aspirated	TR5	2238			TR5IX	7397	TR5GP	3186	TR5	2238	.035
		Turbo	BP6ET	1263									.032
	L4 2.5L	DIESEL	Y-924J	3473									
	V6 2.8L		TR5	2238			TR5IX	7397	TR5GP	3186	TR5	2238	.025
1987	L4 2.0L		BPR6ES	7131			BPR6EIX	6637	BPR6EGP	7084	BPR6EY	6427	.024
		Naturally Aspirated	TR5	2238			TR5IX	7397	TR5GP	3186	TR5	2238	.035
	Turbo	BP6ET	1263									.032	
	L4 2.5L	DIESEL	Y-924J	3473									
	V6 2.8L		TR5	2238			TR5IX	7397	TR5GP	3186	TR5	2238	.025
1986	L4 2.0L		BPR6ES	7131			BPR6EIX	6637	BPR6EGP	7084	BPR6EY	6427	.024
			BP6ET	1263									.032
	L4 2.3L	DIESEL	Y-208T	1250									
	L4 2.5L	DIESEL	Y-924J	3473									



Year	Cyl. L	Notes	Original Equipment		Ruthenium HX		Iridium IX		G-Power		V-Power		Gap
			Part	Stock	Part	Stock	Part	Stock	Part	Stock	Part	Stock	
<b>PEUGEOT (Cont'd)</b>													
<b>505 (Cont'd)</b>													
1985	L4 2.0L		BPR6ES	7131			BPR6EIX	6637	BPR6EGP	7084	BPR6EY	6427	.024
	L4 2.2L		BPR6ES	7131			BPR6EIX	6637	BPR6EGP	7084	BPR6EY	6427	.036
	L4 2.3L	DIESEL	Y-208T	1250									
	L4 2.5L	DIESEL	Y-924J	3473									
<b>PLYMOUTH</b>													
<b>Acclaim</b>													
1995-89	L4 2.5L		GR4	2635			GR4IX	97382	GR4GP	2763	GR4	2635	.035
	V6 3.0L		BPR5ES-11	7634			BPR5EIX-11	2115	BPR5EGP	7082	BPR5EY-11	6937	.044
<b>Breeze</b>													
2000-97	L4 2.0L		BKR6E	6962	FR6BHX-S	95159	BKR6EIX	6418	BKR6EGP	7092	BKR6E	6962	.035
	L4 2.4L		FR45	3686					FR45GP	3072	FR45	3686	.050
1996	L4 2.0L		BKR6E	6962			BKR6EIX	6418	BKR6EGP	7092	BKR6E	6962	.035
	L4 2.4L		FR45	3686					FR45GP	3072	FR45	3686	.050
<b>Caravelle</b>													
1989	V8 5.2L		GR4	2635			GR4IX	97382	GR4GP	2763	GR4	2635	.035
1988-86	L4 2.2L		GR4	2635			GR4IX	97382	GR4GP	2763	GR4	2635	.035
	L4 2.5L		GR4	2635			GR4IX	97382	GR4GP	2763	GR4	2635	.035
	V8 5.2L		GR4	2635			GR4IX	97382	GR4GP	2763	GR4	2635	.035
1985	L4 2.2L		GR4	2635			GR4IX	97382	GR4GP	2763	GR4	2635	.035
	L4 2.6L		BPR5ES-11	7634			BPR5EIX-11	2115	BPR5EGP	7082	BPR5EY-11	6937	.040
	V8 5.2L		GR4	2635			GR4IX	97382	GR4GP	2763	GR4	2635	.035
<b>Colt</b>													
1994-93	L4 1.5L		BPR6ES-11	7133			BPR6EIX-11	3903	BPR6EGP	7084	BPR6EY-11	6261	.044
	L4 1.8L		BKR5E-11	6953			BKR5EIX-11	5464	BKR5EGP	7090	BKR5E-11	6953	.044
	L4 2.4L		BKR6E-11	2756			BKR6EIX-11	3764	BKR6EGP	7092	BKR6E-11	2756	.044
1992	L4 1.5L		BPR6ES-11	7133			BPR6EIX-11	3903	BPR6EGP	7084	BPR6EY-11	6261	.044
	L4 1.8L		ZFR6F-11	4291			ZFR6FIX-11	6441	ZFR6FGP	7100	ZFR6F-11	4291	.045
	L4 2.4L		<b>BPR5ES-11</b>	<b>7634</b>			BPR5EIX-11	2115	BPR5EGP	7082	BPR5EY-11	6937	.044
1991	L4 1.5L	Vin A	BPR6EY-11	6261			BPR6EIX-11	3903	BPR6EGP	7084	BPR6EY-11	6261	.044
		Vin K	<b>BPR5ES-11</b>	<b>7634</b>			BPR5EIX-11	2115	BPR5EGP	7082	BPR5EY-11	6937	.045
	L4 2.0L		<b>BPR6ES-11</b>	<b>7133</b>			BPR6EIX-11	3903	BPR6EGP	7084	BPR6EY-11	6261	.044
1990	L4 1.5L	CARB	<b>BPR6ES-11</b>	<b>7133</b>			BPR6EIX-11	3903	BPR6EGP	7084	BPR6EY-11	6261	.044
		FI	BPR6EY-11	6261			BPR6EIX-11	3903	BPR6EGP	7084	BPR6EY-11	6261	.044
	L4 1.6L		BPR6ES-11	7133			BPR6EIX-11	3903	BPR6EGP	7084	BPR6EY-11	6261	.044
	L4 1.8L		<b>BPR6ES-11</b>	<b>7133</b>			BPR6EIX-11	3903	BPR6EGP	7084	BPR6EY-11	6261	.044
1989	L4 2.0L		<b>BPR6ES-11</b>	<b>7133</b>			BPR6EIX-11	3903	BPR6EGP	7084	BPR6EY-11	6261	.044
	L4 1.5L	CARB	<b>BPR6ES-11</b>	<b>7133</b>			BPR6EIX-11	3903	BPR6EGP	7084	BPR6EY-11	6261	.044
		FI	BPR6EY-11	6261			BPR6EIX-11	3903	BPR6EGP	7084	BPR6EY-11	6261	.044
	L4 1.6L	Vin F	BPR6EY-11	6261			BPR6EIX-11	3903	BPR6EGP	7084	BPR6EY-11	6261	.044
		Vin Y	<b>BPR6ES-11</b>	<b>7133</b>			BPR6EIX-11	3903	BPR6EGP	7084	BPR6EY-11	6261	.044
		Vin Z	<b>BPR6ES-11</b>	<b>7133</b>			BPR6EIX-11	3903	BPR6EGP	7084	BPR6EY-11	6261	.044
1988	L4 1.8L		<b>BPR6ES-11</b>	<b>7133</b>			BPR6EIX-11	3903	BPR6EGP	7084	BPR6EY-11	6261	.044
	L4 2.0L		<b>BPR6ES-11</b>	<b>7133</b>			BPR6EIX-11	3903	BPR6EGP	7084	BPR6EY-11	6261	.044
	L4 1.5L	CARB	BPR6EY-11	6261			BPR6EIX-11	3903	BPR6EGP	7084	BPR6EY-11	6261	.044
		FI	<b>BPR6ES-11</b>	<b>7133</b>			BPR6EIX-11	3903	BPR6EGP	7084	BPR6EY-11	6261	.044
1987	L4 1.6L		BPR6ES-11	7133			BPR6EIX-11	3903	BPR6EGP	7084	BPR6EY-11	6261	.044
	L4 2.0L		<b>BPR6ES-11</b>	<b>7133</b>			BPR6EIX-11	3903	BPR6EGP	7084	BPR6EY-11	6261	.044
	L4 1.5L		BPR6ES-11	7133			BPR6EIX-11	3903	BPR6EGP	7084	BPR6EY-11	6261	.044
1986-85	L4 1.5L		BPR6ES-11	7133			BPR6EIX-11	3903	BPR6EGP	7084	BPR6EY-11	6261	.044
	L4 1.6L		BPR7ES-11	7226			BPR7EIX	4055					.044
	L4 2.0L		<b>BPR6ES-11</b>	<b>7133</b>			BPR6EIX-11	3903	BPR6EGP	7084	BPR6EY-11	6261	.044
<b>Conquest</b>													
1986	L4 2.6L		<b>BPR6ES-11</b>	<b>7133</b>			BPR6EIX-11	3903	BPR6EGP	7084	BPR6EY-11	6261	.044
1985	L4 2.6L	Vin H	<b>BPR6ES-11</b>	<b>7133</b>			BPR6EIX-11	3903	BPR6EGP	7084	BPR6EY-11	6261	.044

**Bold denotes NGK OE Manufacturer and/or OE Service Part**  
NOT BOLD denotes OE Equivalent Part

**Le texte en gras désigne une pièce d'équipement originale du manufacturier NGK et/ou pièce d'équipement originale de service**  
Le texte non en gras désigne une pièce d'équipement originale équivalente

Note: Due to different operating or engine conditions, alternate heat range plugs may be required.

Note: En raison de différences au niveau du fonctionnement ou des conditions du moteur, d'autres types de bougies avec variation de chaleur peuvent être nécessaires



Year	Cyl. L	Notes	Original Equipment		Ruthenium HX		Iridium IX		G-Power		V-Power		Gap
			Part	Stock	Part	Stock	Part	Stock	Part	Stock	Part	Stock	
<b>PLYMOUTH (Cont'd)</b>													
Expo													
1989-87	L4 2.2L		GR4	2635			GR4IX	97382	GR4GP	2763	GR4	2635	.035
Grand Voyager													
2000	V6 3.0L		BPR5ES-11	7634			BPR5EIX-11	2115	BPR5EGP	7082	BPR5EY-11	6937	.044
	V6 3.3L		GR45GP	3142					GR45GP	3142	GR45	4268	.050
1999-98	V6 3.0L		BPR5ES-11	7634			BPR5EIX-11	2115	BPR5EGP	7082	BPR5EY-11	6937	.044
	V6 3.3L		GR45GP	3142					GR45GP	3142	GR45	4268	.050
	V6 3.8L		GR45GP	3142					GR45GP	3142	GR45	4268	.050
1997-96	L4 2.4L		FR45	3686					FR45GP	3072	FR45	3686	.050
	V6 3.0L		BPR5ES-11	7634			BPR5EIX-11	2115	BPR5EGP	7082	BPR5EY-11	6937	.044
	V6 3.3L		GR45GP	3142					GR45GP	3142	GR45	4268	.050
1995-94	V6 3.8L		GR45GP	3142					GR45GP	3142	GR45	4268	.050
	V6 3.0L		BPR5ES-11	7634			BPR5EIX-11	2115	BPR5EGP	7082	BPR5EY-11	6937	.044
	V6 3.3L		GR45	4268					GR45GP	3142	GR45	4268	.050
1993	V6 3.8L		GR45	4268					GR45GP	3142	GR45	4268	.050
	V6 3.0L		BPR5ES-11	7634			BPR5EIX-11	2115	BPR5EGP	7082	BPR5EY-11	6937	.044
	V6 3.3L		GR45	4268					GR45GP	3142	GR45	4268	.050
1992	V6 3.0L		<b>BPR5ES-11</b>	<b>7634</b>			BPR5EIX-11	2115	BPR5EGP	7082	BPR5EY-11	6937	.044
	V6 3.3L		GR45	4268					GR45GP	3142	GR45	4268	.050
1991-90	V6 3.3L		GR45	4268					GR45GP	3142	GR45	4268	.050
1989	V6 3.0L		<b>BPR5ES-11</b>	<b>7634</b>			BPR5EIX-11	2115	BPR5EGP	7082	BPR5EY-11	6937	.044
1988-87	L4 2.5L		GR4	2635			GR4IX	97382	GR4GP	2763	GR4	2635	.035
	V6 3.0L		<b>BPR5ES-11</b>	<b>7634</b>			BPR5EIX-11	2115	BPR5EGP	7082	BPR5EY-11	6937	.044
Gran Fury													
1989-85	V8 5.2L		GR4	2635			GR4IX	97382	GR4GP	2763	GR4	2635	.035
Horizon													
1990-87	L4 2.2L		GR4	2635			GR4IX	97382	GR4GP	2763	GR4	2635	.035
1986-85	L4 1.6L		GR4	2635			GR4IX	97382	GR4GP	2763	GR4	2635	.035
	L4 2.2L		GR4	2635			GR4IX	97382	GR4GP	2763	GR4	2635	.035
Laser													
1994-90	L4 1.8L		<b>BPR6ES-11</b>	<b>7133</b>			BPR6EIX-11	3903	BPR6EGP	7084	BPR6EY-11	6261	.044
	L4 2.0L	Naturally Aspirated	<b>BPR6ES-11</b>	<b>7133</b>			BPR6EIX-11	3903	BPR6EGP	7084	BPR6EY-11	6261	.044
		Turbo		BPR6ES	7131			BPR6EIX	6637	BPR6EGP	7084	BPR6EY	6427
Neon													
2001-97	L4 2.0L		BKR6E	6962	FR6BHX-S	95159	BKR6EIX	6418	BKR6EGP	7092	BKR6E	6962	.035
1996-95	L4 2.0L		BKR6E	6962			BKR6EIX	6418	BKR6EGP	7092	BKR6E	6962	.035
Prowler													
2001	V6 3.5L		<b>ZFR5LP-13G</b>	<b>7781</b>			ZFR5FIX-11E	96807	ZFR5FGP-E	94407			.050
2000-99	V6 3.5L		ZFR5LP-13G	7781			ZFR5FIX-11E	96807	ZFR5FGP-E	94407			.050
1997	V6 3.5L		ZFR5LP-13G	7781			ZFR5FIX-11E	96807	ZFR5FGP-E	94407			.050
Reliant													
1989-86	L4 2.2L		GR4	2635			GR4IX	97382	GR4GP	2763	GR4	2635	.035
	L4 2.5L		GR4	2635			GR4IX	97382	GR4GP	2763	GR4	2635	.035
1985	L4 2.2L		GR4	2635			GR4IX	97382	GR4GP	2763	GR4	2635	.035
	L4 2.6L		BPR5ES-11	7634			BPR5EIX-11	2115	BPR5EGP	7082	BPR5EY-11	6937	.040
Sundance													
1994-92	L4 2.2L		GR4	2635			GR4IX	97382	GR4GP	2763	GR4	2635	.035
	L4 2.5L		GR4	2635			GR4IX	97382	GR4GP	2763	GR4	2635	.035
	V6 3.0L		BPR5ES-11	7634			BPR5EIX-11	2115	BPR5EGP	7082	BPR5EY-11	6937	.044
1991-88	L4 2.2L		GR4	2635			GR4IX	97382	GR4GP	2763	GR4	2635	.035
	L4 2.5L		GR4	2635			GR4IX	97382	GR4GP	2763	GR4	2635	.035
1987	L4 2.2L		GR4	2635			GR4IX	97382	GR4GP	2763	GR4	2635	.035
Turismo													
1985	L4 1.6L		GR4	2635			GR4IX	97382	GR4GP	2763	GR4	2635	.035
Voyager													
2000	L4 2.4L		FR45	3686					FR45GP	3072	FR45	3686	.050
	V6 3.0L		BPR5ES-11	7634			BPR5EIX-11	2115	BPR5EGP	7082	BPR5EY-11	6937	.044
	V6 3.3L		GR45GP	3142					GR45GP	3142	GR45	4268	.050



Year	Cyl. L	Notes	Original Equipment		Ruthenium HX		Iridium IX		G-Power		V-Power		Gap
			Part	Stock	Part	Stock	Part	Stock	Part	Stock	Part	Stock	
<b>PLYMOUTH (Cont'd)</b>													
<b>Voyager (Cont'd)</b>													
1999-97	L4 2.4L		FR45	3686					FR45GP	3072	FR45	3686	.050
	V6 3.0L		BPR5ES-11	7634			BPR5EIX-11	2115	BPR5EGP	7082	BPR5EY-11	6937	.044
	V6 3.3L		GR45GP	3142					GR45GP	3142	GR45	4268	.050
	V6 3.8L		GR45GP	3142					GR45GP	3142	GR45	4268	.050
1996	L4 2.4L		FR45	3686					FR45GP	3072	FR45	3686	.050
	V6 3.0L		BPR5ES-11	7634			BPR5EIX-11	2115	BPR5EGP	7082	BPR5EY-11	6937	.044
	V6 3.3L		GR45GP	3142					GR45GP	3142	GR45	4268	.050
1995-93	L4 2.5L		GR4	2635			GR4IX	97382	GR4GP	2763	GR4	2635	.035
	V6 3.0L		BPR5ES-11	7634			BPR5EIX-11	2115	BPR5EGP	7082	BPR5EY-11	6937	.044
	V6 3.3L		GR45	4268					GR45GP	3142	GR45	4268	.050
1992-91	L4 2.5L		GR4	2635			GR4IX	97382	GR4GP	2763	GR4	2635	.035
	V6 3.0L		<b>BPR5ES-11</b>	<b>7634</b>			BPR5EIX-11	2115	BPR5EGP	7082	BPR5EY-11	6937	.044
	V6 3.3L		GR45	4268					GR45GP	3142	GR45	4268	.050
1990-88	L4 2.5L		GR4	2635			GR4IX	97382	GR4GP	2763	GR4	2635	.035
	V6 3.0L		<b>BPR5ES-11</b>	<b>7634</b>			BPR5EIX-11	2115	BPR5EGP	7082	BPR5EY-11	6937	.044
1987	L4 2.2L		GR4	2635			GR4IX	97382	GR4GP	2763	GR4	2635	.035
	L4 2.5L		GR4	2635			GR4IX	97382	GR4GP	2763	GR4	2635	.035
	L4 2.6L		<b>BPR5ES-11</b>	<b>7634</b>			BPR5EIX-11	2115	BPR5EGP	7082	BPR5EY-11	6937	.040
	V6 3.0L		<b>BPR5ES-11</b>	<b>7634</b>			BPR5EIX-11	2115	BPR5EGP	7082	BPR5EY-11	6937	.044
1986-85	L4 2.2L		GR4	2635			GR4IX	97382	GR4GP	2763	GR4	2635	.035
	L4 2.6L		<b>BPR5ES-11</b>	<b>7634</b>			BPR5EIX-11	2115	BPR5EGP	7082	BPR5EY-11	6937	.040
<b>PONTIAC</b>													
<b>6000</b>													
1991-90	L4 2.5L		UR55	2248			UR55IX	7272			UR55	2248	.060
	V6 3.1L		TR4	3754			TR4IX	7300	TR4GP	2815	TR4	3754	.045
1989-88	L4 2.5L		UR55	2248			UR55IX	7272			UR55	2248	.060
	V6 2.8L		TR4	3754			TR4IX	7300	TR4GP	2815	TR4	3754	.045
	V6 3.1L		TR4	3754			TR4IX	7300	TR4GP	2815	TR4	3754	.045
1987	L4 2.5L		UR55	2248			UR55IX	7272			UR55	2248	.060
	V6 2.8L		TR4	3754			TR4IX	7300	TR4GP	2815	TR4	3754	.045
1986-85	L4 2.5L		UR55	2248			UR55IX	7272			UR55	2248	.060
	V6 2.8L		UR5	2771			UR5IX	7177	UR5GP	3547	UR5	2771	.045
<b>Acadian</b>													
1987-85	L4 1.6L		UR5	2771			UR5IX	7177	UR5GP	3547	UR5	2771	.035
<b>Aztek</b>													
2005-03	V6 3.4L		<b>ITR4A15</b>	<b>5599</b>	TR4BHX	97100	TR55IX	7164	TR55GP	3403	TR55	3951	.060
2002-01	V6 3.4L		ITR4A15	5599	TR4BHX	97100	TR55IX	7164	TR55GP	3403	TR55	3951	.060
<b>Bonneville</b>													
2005-04	V6 3.8L		<b>ITR4A15</b>	<b>5599</b>	TR4BHX	97100	TR55IX	7164	TR55GP	3403	TR55	3951	.060
	V8 4.6L		PTR5C-13	7740	TR5AHX	94567	TR55IX	7164	TR55GP	3403	TR55	3951	.052
2003	V6 3.8L		<b>ITR4A15</b>	<b>5599</b>	TR4BHX	97100	TR55IX	7164	TR55GP	3403	TR55	3951	.060
2002-97	V6 3.8L		ITR4A15	5599	TR4BHX	97100	TR55IX	7164	TR55GP	3403	TR55	3951	.060
1996-94	V6 3.8L		ITR4A15	5599			TR55IX	7164	TR55GP	3403	TR55	3951	.060
1993-89	V6 3.8L		TR55	3951			TR55IX	7164	TR55GP	3403	TR55	3951	.060
1988	V6 3.8L	Vin 3	TR5	2238			TR5IX	7397	TR5GP	3186	TR5	2238	.045
		Vin C	TR55	3951			TR55IX	7164	TR55GP	3403	TR55	3951	.060
1987	V6 3.8L		TR5	2238			TR5IX	7397	TR5GP	3186	TR5	2238	.045
1986	V6 3.8L		UR45	6945			UR45IX	7559	UR45GP	3207	UR45	6945	.060
	V6 4.3L		UR4	6630			UR4IX	7401	UR4GP	2869	UR4	6630	.035
	V8 5.0L		UR5	2771			UR5IX	7177	UR5GP	3547	UR5	2771	.035
1985	V6 3.8L		UR45	6945			UR45IX	7559	UR45GP	3207	UR45	6945	.060
	V8 5.0L		UR4	6630			UR4IX	7401	UR4GP	2869	UR4	6630	.045
<b>Fiero</b>													
1988-85	L4 2.5L		UR55	2248			UR55IX	7272			UR55	2248	.060
	V6 2.8L		UR5	2771			UR5IX	7177	UR5GP	3547	UR5	2771	.045
<b>Firebird</b>													
2002-98	V6 3.8L		ITR4A15	5599	TR4BHX	97100	TR55IX	7164	TR55GP	3403	TR55	3951	.060

**Bold denotes NGK OE Manufacturer and/or OE Service Part**  
NOT BOLD denotes OE Equivalent Part

**Le texte en gras désigne une pièce d'équipement originale du manufacturier NGK et/ou pièce d'équipement originale de service**  
Le texte non en gras désigne une pièce d'équipement originale équivalente

Note: Due to different operating or engine conditions, alternate heat range plugs may be required.

Note: En raison de différences au niveau du fonctionnement ou des conditions du moteur, d'autres types de bougies avec variation de chaleur peuvent être nécessaires





Year	Cyl. L	Notes	Original Equipment		Ruthenium HX		Iridium IX		G-Power		V-Power		Gap
			Part	Stock	Part	Stock	Part	Stock	Part	Stock	Part	Stock	
<b>PONTIAC (Cont'd)</b>													
<b>Firebird (Cont'd)</b>													
2002-98	V8 5.7L		PTR5D-10	3784	TR5AHX	94567	TR5IX	7397	TR5GP	3186	TR5	2238	.040
1997	V6 3.8L		ITR4A15	5599	TR4BHX	97100	TR55IX	7164	TR55GP	3403	TR55	3951	.060
	V8 5.7L		PTR5F-11	6579	TR5AHX	94567	TR55IX	7164	TR55GP	3403	TR55	3951	.050
1996	V6 3.8L		ITR4A15	5599			TR55IX	7164	TR55GP	3403	TR55	3951	.060
	V8 5.7L		PTR5F-11	6579			TR55IX	7164	TR55GP	3403	TR55	3951	.050
1995	V6 3.4L		BPR6FS	2623			UR6IX	7348	UR6GP	7966	UR6	7773	.045
	V6 3.8L		ITR4A15	5599			TR55IX	7164	TR55GP	3403	TR55	3951	.060
	V8 5.7L		PTR5F-11	6579			TR55IX	7164	TR55GP	3403	TR55	3951	.050
1994	V6 3.4L		BPR6FS	2623			UR6IX	7348	UR6GP	7966	UR6	7773	.045
	V8 5.7L		PTR5F-11	6579			TR55IX	7164	TR55GP	3403	TR55	3951	.050
1993	V6 3.4L		BPR6FS	2623			UR6IX	7348	UR6GP	7966	UR6	7773	.045
	V8 5.7L		TR55	3951			TR55IX	7164	TR55GP	3403	TR55	3951	.050
1992-90	V6 3.1L		UR5	2771			UR5IX	7177	UR5GP	3547	UR5	2771	.045
	V8 5.0L		UR4	6630			UR4IX	7401	UR4GP	2869	UR4	6630	.035
	V8 5.7L		UR4	6630			UR4IX	7401	UR4GP	2869	UR4	6630	.035
1989	V6 2.8L		UR5	2771			UR5IX	7177	UR5GP	3547	UR5	2771	.045
	V6 3.8L		TR6	4177			TR6IX	3689	TR6GP	5141	TR6	4177	.045
	V8 5.0L		UR4	6630			UR4IX	7401	UR4GP	2869	UR4	6630	.035
	V8 5.7L		UR4	6630			UR4IX	7401	UR4GP	2869	UR4	6630	.035
1988	V6 2.8L		UR5	2771			UR5IX	7177	UR5GP	3547	UR5	2771	.045
	V8 5.0L		UR4	6630			UR4IX	7401	UR4GP	2869	UR4	6630	.035
	V8 5.7L		UR4	6630			UR4IX	7401	UR4GP	2869	UR4	6630	.035
1987	V6 2.8L		UR5	2771			UR5IX	7177	UR5GP	3547	UR5	2771	.045
	V8 5.0L	CARB	UR4	6630			UR4IX	7401	UR4GP	2869	UR4	6630	.035
		FI	UR5	2771			UR5IX	7177	UR5GP	3547	UR5	2771	.035
	V8 5.7L	Aluminum Heads	FR4	5155			BKR4EIX	5693	FR4GP	2685	FR4	5155	.035
		Cast Iron Heads	UR5	2771			UR5IX	7177	UR5GP	3547	UR5	2771	.035
1986	L4 2.5L		UR55	2248			UR55IX	7272			UR55	2248	.060
	V6 2.8L		UR5	2771			UR5IX	7177	UR5GP	3547	UR5	2771	.045
	V8 5.0L		UR5	2771			UR5IX	7177	UR5GP	3547	UR5	2771	.035
1985	L4 2.5L		UR55	2248			UR55IX	7272			UR55	2248	.060
	V6 2.8L		UR5	2771			UR5IX	7177	UR5GP	3547	UR5	2771	.045
	V8 5.0L	Vin F	UR5	2771			UR5IX	7177	UR5GP	3547	UR5	2771	.045
		Vin G	UR5	2771			UR5IX	7177	UR5GP	3547	UR5	2771	.045
		Vin H	UR4	6630			UR4IX	7401	UR4GP	2869	UR4	6630	.045
<b>Firefly</b>													
2000-96	L3 1.0L		<b>BPR6ES-11</b>	<b>7133</b>			BPR6EIX-11	3903	BPR6EGP	7084	BPR6EY-11	6261	.042
	L4 1.3L		BPR6EY-11	6261			BPR6EIX-11	3903	BPR6EGP	7084	BPR6EY-11	6261	.042
1995-94	L3 1.0L		<b>BPR6ES-11</b>	<b>7133</b>			BPR6EIX-11	3903	BPR6EGP	7084	BPR6EY-11	6261	.042
	L4 1.3L		<b>BPR6ES-11</b>	<b>7133</b>			BPR6EIX-11	3903	BPR6EGP	7084	BPR6EY-11	6261	.042
1991-89	L3 1.0L		<b>BPR6ES-11</b>	<b>7133</b>			BPR6EIX-11	3903	BPR6EGP	7084	BPR6EY-11	6261	.042
1988-87	L3 1.0L	Naturally Aspirated	GR5	2851			GR5IX	7214	GR5GP	3351	GR5	2851	.045
		Turbo	<b>BPR6ES-11</b>	<b>7133</b>			BPR6EIX-11	3903	BPR6EGP	7084	BPR6EY-11	6261	.042
1986-85	L3 1.0L		GR5	2851			GR5IX	7214	GR5GP	3351	GR5	2851	.045
<b>G3</b>													
2010-09	L4 1.6L		<b>ZFR6U-9</b>	<b>90318</b>	FR6AHX-S	94279	ZFR6FIX-11	6441	ZFR6FGP	7100	ZFR6U-9	90318	.036
<b>G3 Wave</b>													
2009	L4 1.6L		<b>ZFR6U-9</b>	<b>90318</b>	FR6AHX-S	94279	ZFR6FIX-11	6441	ZFR6FGP	7100	ZFR6U-9	90318	.036
<b>G5</b>													
2010-09	L4 2.2L		<b>ILTR5B11</b>	<b>3474</b>	LTR5AHX	90220	LTR5IX-11	4344	LTR5GP	5019			.044
2008-07	L4 2.2L		<b>ILTR5B11</b>	<b>3474</b>	LTR5AHX	90220	LTR5IX-11	4344	LTR5GP	5019			.044
	L4 2.4L		<b>ILTR5B11</b>	<b>3474</b>	LTR5AHX	90220	LTR5IX-11	4344	LTR5GP	5019			.044
<b>G6</b>													
2010	L4 2.4L		<b>ILTR5E11</b>	<b>91418</b>	LTR5AHX	90220	LTR5IX-11	4344	LTR5GP	5019			.044
	V6 3.5L		<b>IZTR4A11</b>	<b>4213</b>			TR4IX	7300	TR4GP	2815	TR4	3754	.044
2009-07	L4 2.4L		<b>ILTR5B11</b>	<b>3474</b>	LTR5AHX	90220	LTR5IX-11	4344	LTR5GP	5019			.044
	V6 3.5L		<b>IZTR4A11</b>	<b>4213</b>			TR4IX	7300	TR4GP	2815	TR4	3754	.044



Year	Cyl. L	Notes	Original Equipment		Ruthenium HX		Iridium IX		G-Power		V-Power		Gap
			Part	Stock	Part	Stock	Part	Stock	Part	Stock	Part	Stock	
<b>PONTIAC (Cont'd)</b>													
<b>G6 (Cont'd)</b>													
2009-07	V6 3.6L		PLTR6A-10G	3587	LTR6AHX	91276	LTR6IX-11	6509	LTR6GP	90198			.044
	V6 3.9L		<b>IZTR4A11</b>	<b>4213</b>			TR4IX	7300	TR4GP	2815	TR4	3754	.044
2006	L4 2.4L		<b>ILTR5B11</b>	<b>3474</b>	LTR5AHX	90220	LTR5IX-11	4344	LTR5GP	5019			.044
	V6 3.5L		<b>ITR4A15</b>	<b>5599</b>	TR4BHX	97100	TR55IX	7164	TR55GP	3403	TR55	3951	.060
	V6 3.9L		<b>IZTR4A11</b>	<b>4213</b>			TR4IX	7300	TR4GP	2815	TR4	3754	.044
2005	V6 3.5L		<b>ITR4A15</b>	<b>5599</b>	TR4BHX	97100	TR55IX	7164	TR55GP	3403	TR55	3951	.060
<b>G8</b>													
2009	V6 3.6L		PLTR6A-10G	3587	LTR6AHX	91276	LTR6IX-11	6509	LTR6GP	90198			.044
	V8 6.0L		IZTR5B11	1465	TR5AHX	94567	TR5IX	7397	TR5GP	3186	TR5	2238	.040
	V8 6.2L		IZTR5B11	1465	TR5AHX	94567	TR5IX	7397	TR5GP	3186	TR5	2238	.040
2008	V6 3.6L		PLTR6A-10G	3587	LTR6AHX	91276	LTR6IX-11	6509	LTR6GP	90198			.044
	V8 6.0L		IZTR5B11	1465	TR5AHX	94567	TR5IX	7397	TR5GP	3186	TR5	2238	.040
<b>Grand Am</b>													
2005-03	L4 2.2L		<b>ILTR5C11</b>	<b>5581</b>			LTR5IX-11	4344	LTR5GP	5019			.044
	V6 3.4L		<b>ITR4A15</b>	<b>5599</b>	TR4BHX	97100	TR55IX	7164	TR55GP	3403	TR55	3951	.060
2002	L4 2.2L		<b>ILTR5C11</b>	<b>5581</b>			LTR5IX-11	4344	LTR5GP	5019			.044
	V6 3.4L		ITR4A15	5599	TR4BHX	97100	TR55IX	7164	TR55GP	3403	TR55	3951	.060
2001-99	L4 2.4L		PTR5F-11	6579	TR5AHX	94567	TR55IX	7164	TR55GP	3403	TR55	3951	.050
	V6 3.4L		ITR4A15	5599	TR4BHX	97100	TR55IX	7164	TR55GP	3403	TR55	3951	.060
1998-97	L4 2.4L		PZTR5A-15	7862	TR5AHX	94567	TR55IX	7164	TR55GP	3403	TR55	3951	.060
	V6 3.1L		ITR4A15	5599	TR4BHX	97100	TR55IX	7164	TR55GP	3403	TR55	3951	.060
1996	L4 2.4L		PZTR5A-15	7862			TR55IX	7164	TR55GP	3403	TR55	3951	.060
	V6 3.1L		ITR4A15	5599			TR55IX	7164	TR55GP	3403	TR55	3951	.060
1995	L4 2.3L		PZTR5A-15	7862			TR55IX	7164	TR55GP	3403	TR55	3951	.060
	V6 3.1L		ITR4A15	5599			TR55IX	7164	TR55GP	3403	TR55	3951	.060
1994	L4 2.3L	Vin 3	FR4	5155			BKR4EIX	5693	FR4GP	2685	FR4	5155	.035
		Vin A	BKR5E	7938			BKR5EIX	6341	BKR5EGP	7090	BKR5E	7938	.035
		Vin D	FR4	5155			BKR4EIX	5693	FR4GP	2685	FR4	5155	.035
	V6 3.1L		ITR4A15	5599			TR55IX	7164	TR55GP	3403	TR55	3951	.060
1993	L4 2.3L	Vin 3	FR4	5155			BKR4EIX	5693	FR4GP	2685	FR4	5155	.035
		Vin A	BKR5E	7938			BKR5EIX	6341	BKR5EGP	7090	BKR5E	7938	.035
		Vin D	FR4	5155			BKR4EIX	5693	FR4GP	2685	FR4	5155	.035
	V6 3.3L		TR55	3951			TR55IX	7164	TR55GP	3403	TR55	3951	.060
1992	L4 2.3L		FR4	5155			BKR4EIX	5693	FR4GP	2685	FR4	5155	.035
	V6 3.3L		TR55	3951			TR55IX	7164	TR55GP	3403	TR55	3951	.060
1991-90	L4 2.3L		FR4	5155			BKR4EIX	5693	FR4GP	2685	FR4	5155	.035
	L4 2.5L		UR55	2248			UR55IX	7272			UR55	2248	.060
1989-88	L4 2.0L		GR5	2851			GR5IX	7214	GR5GP	3351	GR5	2851	.035
	L4 2.3L		FR4	5155			BKR4EIX	5693	FR4GP	2685	FR4	5155	.035
	L4 2.5L		UR55	2248			UR55IX	7272			UR55	2248	.060
1987	L4 2.0L		GR5	2851			GR5IX	7214	GR5GP	3351	GR5	2851	.035
	L4 2.5L		UR55	2248			UR55IX	7272			UR55	2248	.060
	V6 3.0L		TR5	2238			TR5IX	7397	TR5GP	3186	TR5	2238	.045
1986-85	L4 2.5L		UR55	2248			UR55IX	7272			UR55	2248	.060
	V6 3.0L		TR5	2238			TR5IX	7397	TR5GP	3186	TR5	2238	.045
<b>Grand Prix</b>													
2008-05	V6 3.8L		<b>ITR4A15</b>	<b>5599</b>	TR4BHX	97100	TR55IX	7164	TR55GP	3403	TR55	3951	.060
	V8 5.3L		IZTR5B11	1465	TR5AHX	94567	TR5IX	7397	TR5GP	3186	TR5	2238	.040
2004	V6 3.8L		<b>ITR4A15</b>	<b>5599</b>	TR4BHX	97100	TR55IX	7164	TR55GP	3403	TR55	3951	.060
2003	V6 3.1L		ITR4A15	5599	TR4BHX	97100	TR55IX	7164	TR55GP	3403	TR55	3951	.060
	V6 3.8L		<b>ITR4A15</b>	<b>5599</b>	TR4BHX	97100	TR55IX	7164	TR55GP	3403	TR55	3951	.060
2002-98	V6 3.1L		ITR4A15	5599	TR4BHX	97100	TR55IX	7164	TR55GP	3403	TR55	3951	.060
		Naturally Aspirated	ITR4A15	5599	TR4BHX	97100	TR55IX	7164	TR55GP	3403	TR55	3951	.060
	V6 3.8L	Supercharged	<b>ITR4A15</b>	<b>5599</b>	TR4BHX	97100	TR55IX	7164	TR55GP	3403	TR55	3951	.060
1997	V6 3.1L		ITR4A15	5599	TR4BHX	97100	TR55IX	7164	TR55GP	3403	TR55	3951	.060
	V6 3.8L		ITR4A15	5599	TR4BHX	97100	TR55IX	7164	TR55GP	3403	TR55	3951	.060
1996	V6 3.1L		ITR4A15	5599			TR55IX	7164	TR55GP	3403	TR55	3951	.060

**Bold denotes NGK OE Manufacturer and/or OE Service Part**  
NOT BOLD denotes OE Equivalent Part

**Le texte en gras désigne une pièce d'équipement originale du manufacturier NGK et/ou pièce d'équipement originale de service**  
Le texte non en gras désigne une pièce d'équipement originale équivalente

Note: Due to different operating or engine conditions, alternate heat range plugs may be required.

Note: En raison de différences au niveau du fonctionnement ou des conditions du moteur, d'autres types de bougies avec variation de chaleur peuvent être nécessaires



Year	Cyl. L	Notes	Original Equipment		Ruthenium HX		Iridium IX		G-Power		V-Power		Gap
			Part	Stock	Part	Stock	Part	Stock	Part	Stock	Part	Stock	
<b>PONTIAC (Cont'd)</b>													
<b>Grand Prix (Cont'd)</b>													
1996	V6 3.4L		ITR4A15	5599			TR55IX	7164	TR55GP	3403	TR55	3951	.060
1995-94	V6 3.1L		ITR4A15	5599			TR55IX	7164	TR55GP	3403	TR55	3951	.060
	V6 3.4L		PTR5F-11	6579			TR5IX	7397	TR5GP	3186	TR5	2238	.045
1993-92	V6 3.1L		TR4	3754			TR4IX	7300	TR4GP	2815	TR4	3754	.045
	V6 3.4L		TR5	2238			TR5IX	7397	TR5GP	3186	TR5	2238	.045
1991	L4 2.3L		FR4	5155			BKR4EIX	5693	FR4GP	2685	FR4	5155	.035
	V6 3.1L		TR4	3754			TR4IX	7300	TR4GP	2815	TR4	3754	.045
	V6 3.4L		TR5	2238			TR5IX	7397	TR5GP	3186	TR5	2238	.045
1990	L4 2.3L		FR4	5155			BKR4EIX	5693	FR4GP	2685	FR4	5155	.035
	V6 3.1L	Naturally Aspirated	TR4	3754			TR4IX	7300	TR4GP	2815	TR4	3754	.045
		Turbo	TR6	4177			TR6IX	3689	TR6GP	5141	TR6	4177	.045
1989	V6 2.8L		TR4	3754			TR4IX	7300	TR4GP	2815	TR4	3754	.045
	V6 3.1L	Naturally Aspirated	TR4	3754			TR4IX	7300	TR4GP	2815	TR4	3754	.045
		Turbo	TR6	4177			TR6IX	3689	TR6GP	5141	TR6	4177	.045
1988	V6 2.8L		TR4	3754			TR4IX	7300	TR4GP	2815	TR4	3754	.045
1987	V6 3.8L		UR45	6945			UR45IX	7559	UR45GP	3207	UR45	6945	.060
	V6 4.3L		UR4	6630			UR4IX	7401	UR4GP	2869	UR4	6630	.035
	V8 5.0L		UR4	6630			UR4IX	7401	UR4GP	2869	UR4	6630	.035
1986	V6 3.8L		UR45	6945			UR45IX	7559	UR45GP	3207	UR45	6945	.060
	V6 4.3L		UR4	6630			UR4IX	7401	UR4GP	2869	UR4	6630	.035
	V8 5.0L		UR5	2771			UR5IX	7177	UR5GP	3547	UR5	2771	.035
1985	V6 3.8L		UR45	6945			UR45IX	7559	UR45GP	3207	UR45	6945	.060
	V8 5.0L		UR4	6630			UR4IX	7401	UR4GP	2869	UR4	6630	.045
<b>GTO</b>													
2006-05	V8 6.0L		PTR5D-10	3784	TR5AHX	94567	TR5IX	7397	TR5GP	3186	TR5	2238	.040
2004	V8 5.7L		PTR5D-10	3784	TR5AHX	94567	TR5IX	7397	TR5GP	3186	TR5	2238	.040
<b>J2000 Sunbird</b>													
1985	L4 1.8L		GR5	2851			GR5IX	7214	GR5GP	3351	GR5	2851	.035
	L4 2.0L		UR5	2771			UR5IX	7177	UR5GP	3547	UR5	2771	.035
<b>LeMans</b>													
1993-91	L4 1.6L		GR45	4268					GR45GP	3142	GR45	4268	.060
1990-89	L4 1.6L		GR45	4268					GR45GP	3142	GR45	4268	.060
	L4 2.0L		GR4	2635			GR4IX	97382	GR4GP	2763	GR4	2635	.045
1988	L4 1.6L		GR45	4268					GR45GP	3142	GR45	4268	.060
<b>Montana</b>													
2009-07	V6 3.9L		<b>IZTR4A11</b>	<b>4213</b>			TR4IX	7300	TR4GP	2815	TR4	3754	.044
2006	V6 3.5L		<b>ITR4A15</b>	<b>5599</b>	TR4BHX	97100	TR55IX	7164	TR55GP	3403	TR55	3951	.060
	V6 3.9L		<b>IZTR4A11</b>	<b>4213</b>			TR4IX	7300	TR4GP	2815	TR4	3754	.044
2005	V6 3.4L		<b>ITR4A15</b>	<b>5599</b>	TR4BHX	97100	TR55IX	7164	TR55GP	3403	TR55	3951	.060
	V6 3.5L		<b>ITR4A15</b>	<b>5599</b>	TR4BHX	97100	TR55IX	7164	TR55GP	3403	TR55	3951	.060
2004-03	V6 3.4L		<b>ITR4A15</b>	<b>5599</b>	TR4BHX	97100	TR55IX	7164	TR55GP	3403	TR55	3951	.060
2002-99	V6 3.4L		ITR4A15	5599	TR4BHX	97100	TR55IX	7164	TR55GP	3403	TR55	3951	.060
<b>Optima</b>													
1991	L4 1.6L		GR45	4268					GR45GP	3142	GR45	4268	.060
1990-88	L4 1.6L		GR45	4268					GR45GP	3142	GR45	4268	.060
	L4 2.0L		GR4	2635			GR4IX	97382	GR4GP	2763	GR4	2635	.045
<b>Parisienne</b>													
1986	V6 4.3L		UR4	6630			UR4IX	7401	UR4GP	2869	UR4	6630	.035
	V8 5.0L	Vin H	UR5	2771			UR5IX	7177	UR5GP	3547	UR5	2771	.035
		Vin Y	FR45	3686					FR45GP	3072	FR45	3686	.060
1985	V6 3.8L		UR45	6945			UR45IX	7559	UR45GP	3207	UR45	6945	.060
	V6 4.3L		UR4	6630			UR4IX	7401	UR4GP	2869	UR4	6630	.035
	V8 5.0L		UR4	6630			UR4IX	7401	UR4GP	2869	UR4	6630	.045
<b>Pursuit</b>													
2006	L4 2.2L		<b>ILTR5C11</b>	<b>5581</b>			LTR5IX-11	4344	LTR5GP	5019			.044
	L4 2.4L		ILTR5B11	3474	LTR5AHX	90220	LTR5IX-11	4344	LTR5GP	5019			.044
2005	L4 2.2L		<b>ILTR5C11</b>	<b>5581</b>			LTR5IX-11	4344	LTR5GP	5019			.044



Year	Cyl. L	Notes	Original Equipment		Ruthenium HX		Iridium IX		G-Power		V-Power		Gap
			Part	Stock	Part	Stock	Part	Stock	Part	Stock	Part	Stock	
<b>PONTIAC (Cont'd)</b>													
<b>Safari</b>													
1989-87	V8 5.0L		FR45	3686					FR45GP	3072	FR45	3686	.060
<b>Solstice</b>													
2009-08	L4 2.0L		<b>ILTR5D</b>	<b>5476</b>			LTR5IX-11	4344	LTR5GP	5019			.036
	L4 2.4L		<b>ILTR5B11</b>	<b>3474</b>	LTR5AHX	90220	LTR5IX-11	4344	LTR5GP	5019			.044
2007	L4 2.0L						LTR6IX-11	6509					.036
	L4 2.4L		<b>ILTR5B11</b>	<b>3474</b>	LTR5AHX	90220	LTR5IX-11	4344	LTR5GP	5019			.044
2006	L4 2.4L		<b>ILTR5B11</b>	<b>3474</b>	LTR5AHX	90220	LTR5IX-11	4344	LTR5GP	5019			.044
<b>Sunbird</b>													
1994-92	L4 2.0L		GR5	2851			GR5IX	7214	GR5GP	3351	GR5	2851	.045
	V6 3.1L		TR4	3754			TR4IX	7300	TR4GP	2815	TR4	3754	.045
1991	L4 2.0L		GR4	2635			GR4IX	97382	GR4GP	2763	GR4	2635	.045
	V6 3.1L		TR4	3754			TR4IX	7300	TR4GP	2815	TR4	3754	.045
1990-89	L4 2.0L	Naturally Aspirated	GR4	2635			GR4IX	97382	GR4GP	2763	GR4	2635	.045
		Turbo	GR5	2851			GR5IX	7214	GR5GP	3351	GR5	2851	.035
1988-87	L4 2.0L	Naturally Aspirated	GR45	4268					GR45GP	3142	GR45	4268	.060
		Turbo	GR5	2851			GR5IX	7214	GR5GP	3351	GR5	2851	.035
1986	L4 1.8L		GR5	2851			GR5IX	7214	GR5GP	3351	GR5	2851	.035
	L4 2.0L		UR5	2771			UR5IX	7177	UR5GP	3547	UR5	2771	.035
<b>Sunburst</b>													
1988-85	L4 1.5L		GR5	2851			GR5IX	7214	GR5GP	3351	GR5	2851	.045
<b>Sunfire</b>													
2005-03	L4 2.2L		<b>ILTR5C11</b>	<b>5581</b>			LTR5IX-11	4344	LTR5GP	5019			.044
2002	L4 2.2L	Vin 4, OHV	PTR5D-10	3784			TR5IX	7397	TR5GP	3186	TR5	2238	.040
		Vin F, DOHC	<b>ILTR5C11</b>	<b>5581</b>			LTR5IX-11	4344	LTR5GP	5019			.044
2001-98	L4 2.4L		PTR5C-13	7740	TR5AHX	94567	TR55IX	7164	TR55GP	3403	TR55	3951	.050
	L4 2.2L		PTR5D-10	3784			TR5IX	7397	TR5GP	3186	TR5	2238	.040
1997	L4 2.2L		PZTR5A-15	7862			TR55-1IX	7316	TR55-1GP	7159	TR55-1	2683	.060
	L4 2.4L		PTR5C-13	7740	TR5AHX	94567	TR55IX	7164	TR55GP	3403	TR55	3951	.050
1996	L4 2.2L		PZTR5A-15	7862			TR55-1IX	7316	TR55-1GP	7159	TR55-1	2683	.060
	L4 2.4L		PTR5C-13	7740			TR55IX	7164	TR55GP	3403	TR55	3951	.050
1995	L4 2.2L		PZTR5A-15	7862			TR55-1IX	7316	TR55-1GP	7159	TR55-1	2683	.060
	L4 2.3L		PZTR5A-15	7862			TR55IX	7164	TR55GP	3403	TR55	3951	.060
<b>Sunrunner</b>													
1997	L4 1.6L		<b>BKR6E</b>	<b>6962</b>	FR6AHX-S	94279	BKR6EIX	6418	BKR6EGP	7092	BKR6E	6962	.032
1996-95	L4 1.6L		<b>BKR6E</b>	<b>6962</b>			BKR6EIX	6418	BKR6EGP	7092	BKR6E	6962	.032
1994	L4 1.6L		<b>BPR5ES</b>	<b>7734</b>			BPR5EIX	6597	BPR5EGP	7082	BPR5EY	1233	.032
<b>T1000</b>													
1987-85	L4 1.6L		UR5	2771			UR5IX	7177	UR5GP	3547	UR5	2771	.035
<b>Tempest</b>													
1991-90	L4 2.2L		TR4	3754			TR4IX	7300	TR4GP	2815	TR4	3754	.035
	V6 3.1L		TR4	3754			TR4IX	7300	TR4GP	2815	TR4	3754	.045
1989-87	L4 2.0L		TR4	3754			TR4IX	7300	TR4GP	2815	TR4	3754	.035
	V6 2.8L		TR4	3754			TR4IX	7300	TR4GP	2815	TR4	3754	.045
<b>Torrent</b>													
2009-08	V6 3.4L		<b>ITR4A15</b>	<b>5599</b>	TR4BHX	97100	TR55IX	7164	TR55GP	3403	TR55	3951	.060
	V6 3.6L		PLTR6A-10G	3587	LTR6AHX	91276	LTR6IX-11	6509	LTR6GP	90198			.044
2007-06	V6 3.4L		<b>ITR4A15</b>	<b>5599</b>	TR4BHX	97100	TR55IX	7164	TR55GP	3403	TR55	3951	.060
<b>Trans Sport</b>													
1999-97	V6 3.4L		ITR4A15	5599	TR4BHX	97100	TR55IX	7164	TR55GP	3403	TR55	3951	.060
1996	V6 3.4L		ITR4A15	5599			TR55IX	7164	TR55GP	3403	TR55	3951	.060
1995-94	V6 3.1L		UR5	2771			UR5IX	7177	UR5GP	3547	UR5	2771	.045
	V6 3.8L		ITR4A15	5599			TR55IX	7164	TR55GP	3403	TR55	3951	.060
1993-92	V6 3.1L		UR5	2771			UR5IX	7177	UR5GP	3547	UR5	2771	.045
	V6 3.8L		TR55	3951			TR55IX	7164	TR55GP	3403	TR55	3951	.060
1991-90	V6 3.1L		UR5	2771			UR5IX	7177	UR5GP	3547	UR5	2771	.045

**Bold denotes NGK OE Manufacturer and/or OE Service Part**  
NOT BOLD denotes OE Equivalent Part

**Le texte en gras désigne une pièce d'équipement originale du manufacturier NGK et/ou pièce d'équipement originale de service**  
Le texte non en gras désigne une pièce d'équipement originale équivalente

Note: Due to different operating or engine conditions, alternate heat range plugs may be required.

Note: En raison de différences au niveau du fonctionnement ou des conditions du moteur, d'autres types de bougies avec variation de chaleur peuvent être nécessaires



Year	Cyl. L	Notes	Original Equipment		Ruthenium HX		Iridium IX		G-Power		V-Power		Gap
			Part	Stock	Part	Stock	Part	Stock	Part	Stock	Part	Stock	
<b>PONTIAC (Cont'd)</b>													
<b>Vibe</b>													
2010-09	L4 1.8L		ILKAR7B11	4912	LKAR7AHX-S	92274	LKAR7BIX-11S	93501	LKAR7AGP-D	93220			.044
	L4 2.4L		<b>IFR6T11</b>	<b>4589</b>	FR6AHX-S	94279	BKR6EIX-11	3764	BKR6EGP	7092	BKR6E-11	2756	.044
2008-07	L4 1.8L		<b>IFR5T11</b>	<b>4996</b>	FR5AHX	95839	BKR5EIX-11	5464	BKR5EGP	7090	BKR5E-11	6953	.044
2006-03	L4 1.8L	Eng Desg 1ZZFE	<b>IFR5T11</b>	<b>4996</b>	FR5AHX	95839	BKR5EIX-11	5464	BKR5EGP	7090	BKR5E-11	6953	.044
		Eng Desg 2ZZGE	<b>IFR6T11</b>	<b>4589</b>	FR6AHX-S	94279	BKR6EIX-11	3764	BKR6EGP	7092	BKR6E-11	2756	.044
<b>Wave</b>													
2008-05	L4 1.6L		<b>BKR6E-11</b>	<b>2756</b>	FR6BHX-S	95159	BKR6EIX-11	3764	BKR6EGP	7092	BKR6E-11	2756	.044
<b>Wave5</b>													
2007-05	L4 1.6L		<b>BKR6E-11</b>	<b>2756</b>	FR6BHX-S	95159	BKR6EIX-11	3764	BKR6EGP	7092	BKR6E-11	2756	.044
<b>PORSCHE</b>													
<b>911</b>													
2011	H6 3.8L	GT3	DCPR8EKC	7168									.032
		GT3 RS	DCPR8EKC	7168									.032
	H6 4.0L		DCPR8EKC	7168									.032
2010	H6 3.8L	GT3	DCPR8EKC	7168									.032
2009	H6 3.6L	Turbo	PFR6B	3500	FR6BHX-S	95159	BKR6EIX	6418	BKR6EGP	7092	BKR6E	6962	.028
2008	H6 3.6L	Carrera	BKR7EQUP	4285									.032
		Carrera 4	BKR7EQUP	4285									.032
		GT2	PFR6B	3500	FR6BHX-S	95159	BKR6EIX	6418	BKR6EGP	7092	BKR6E	6962	.028
		GT3	DCPR8EKC	7168									.032
		GT3 RS	DCPR8EKC	7168									.032
		Targa 4	BKR7EQUP	4285									.032
		Turbo	PFR6B	3500	FR6BHX-S	95159	BKR6EIX	6418	BKR6EGP	7092	BKR6E	6962	.028
H6 3.8L		BKR7EQUP	4285			BKR7EIX	2667					.032	
2007	H6 3.6L	Carrera	BKR7EQUP	4285									.032
		Carrera 4	BKR7EQUP	4285									.032
		GT3	DCPR8EKC	7168									.032
		GT3 RS	DCPR8EKC	7168									.032
		Targa 4	BKR7EQUP	4285									.032
		Turbo	PFR6B	3500	FR6BHX-S	95159	BKR6EIX	6418	BKR6EGP	7092	BKR6E	6962	.028
H6 3.8L		BKR7EQUP	4285			BKR7EIX	2667					.032	
2006	H6 3.6L		BKR7EQUP	4285			BKR7EIX	2667					.032
	H6 3.8L		BKR7EQUP	4285			BKR7EIX	2667					.032
2005	H6 3.6L	Carrera	BKR6EKUB	7969	FR6AHX-S	94279	BKR6EIX	6418	BKR6EGP	7092	BKR6E	6962	.032
		Carrera 4S	BKR7EQUP	4285			BKR7EIX	2667			BKR7E	4644	.032
		GT2	BKR7EKC-N	2095			BKR7EIX	2667			BKR7E	4644	.032
		GT3	BKR6EK	2288	FR6AHX-S	94279	BKR6EIX	6418	BKR6EGP	7092	BKR6E	6962	.032
		Turbo	BKR7EKC-N	2095			BKR7EIX	2667			BKR7E	4644	.032
		Turbo S	BKR7EKC-N	2095			BKR7EIX	2667			BKR7E	4644	.032
H6 3.8L		BKR7EKC-N	2095									.032	
2004	H6 3.6L	40th Anniversary Edition	BKR7EQUP	4285			BKR7EIX	2667			BKR7E	4644	.032
		Carrera	BKR7EQUP	4285			BKR7EIX	2667			BKR7E	4644	.032
		Carrera 4	BKR7EQUP	4285			BKR7EIX	2667			BKR7E	4644	.032
		Carrera 4S	BKR7EQUP	4285			BKR7EIX	2667			BKR7E	4644	.032
		GT2	BKR6EK	2288	FR6BHX-S	95159	BKR6EIX	6418	BKR6EGP	7092	BKR6E	6962	.032
		GT3	BKR6EK	2288	FR6BHX-S	95159	BKR6EIX	6418	BKR6EGP	7092	BKR6E	6962	.032
		Turbo	BKR7EKC-N	2095							BKR7E	4644	.032
2003-02	H6 3.6L	Naturally Aspirated	BKR7EQUP	4285			BKR7EIX	2667					.032
		Turbo			FR6BHX-S	95159	BKR6EIX	6418	BKR6EGP	7092	BKR6E	6962	.032
2001	H6 3.4L		BKR6EK	2288	FR6BHX-S	95159	BKR6EIX	6418	BKR6EGP	7092	BKR6E	6962	.032
	H6 3.6L	Turbo	BKR6EQUP	3199	FR6BHX-S	95159	BKR6EIX	6418	BKR6EGP	7092	BKR6E	6962	.032
2000-99	H6 3.4L		BKR6EK	2288	FR6BHX-S	95159	BKR6EIX	6418	BKR6EGP	7092	BKR6E	6962	.032
1998-96	H6 3.6L	Naturally Aspirated, Dual Plug; 12 Req'd	BCPR7ET	5509			BCPR7EIX	5690					.032
		Turbo, Single Plug; 6 Req'd	BCPR7ET	5509			BCPR7EIX	5690					.032





Year	Cyl. L	Notes	Original Equipment		Ruthenium HX		Iridium IX		G-Power		V-Power		Gap
			Part	Stock	Part	Stock	Part	Stock	Part	Stock	Part	Stock	
<b>PORSCHE (Cont'd)</b>													
<b>911 (Cont'd)</b>													
1995	H6 3.6L	Naturally Aspirated, Dual Plug; 12 Req'd	BCPR7ET	5509			BCPR7EIX	5690					.032
1994	H6 3.6L	Carrera 2	BCPR7ET	5509									.032
		Carrera 4	BKR6EK	2288			BKR6EIX	6418	BKR6EGP	7092	BKR6E	6962	.032
		RS America	BCPR7ET	5509									.032
		Speedster	BCPR7ET	5509									.032
		Targa	BCPR7ET	5509									.032
		Turbo 3.6, Dual Plug; 12 Req'd	BKR6EK	2288			BKR6EIX	6418	BKR6EGP	7092	BKR6E	6962	.032
1993	H6 3.6L	Carrera 2	BCPR7ET	5509									.032
		Carrera 4	BKR6EK	2288			BKR6EIX	6418	BKR6EGP	7092	BKR6E	6962	.032
		RS America	BCPR7ET	5509									.032
		Turbo 3.6, Dual Plug; 12 Req'd	BKR6EK	2288			BKR6EIX	6418	BKR6EGP	7092	BKR6E	6962	.032
1992	H6 3.3L		BPR6ES	7131			BPR6EIX	6637	BPR6EGP	7084	BPR6EY	6427	.024
	H6 3.6L	Carrera 2	BCPR7ET	5509									.032
		Carrera 4	BKR6EK	2288			BKR6EIX	6418	BKR6EGP	7092	BKR6E	6962	.032
		RS America	BPR6ES	7131			BPR6EIX	6637	BPR6EGP	7084	BPR6EY	6427	.024
1991	H6 3.3L		BPR6ES	7131			BPR6EIX	6637	BPR6EGP	7084	BPR6EY	6427	.024
	H6 3.6L	Carrera 2	BPR6ES	7131			BPR6EIX	6637	BPR6EGP	7084	BPR6EY	6427	.028
		Carrera 4	BKR6EK	2288			BKR6EIX	6418	BKR6EGP	7092	BKR6E	6962	.032
1990	H6 3.6L		BKR6EK	2288			BKR6EIX	6418	BKR6EGP	7092	BKR6E	6962	.032
1989	H6 3.2L		BPR6ES	7131			BPR6EIX	6637	BPR6EGP	7084	BPR6EY	6427	.028
	H6 3.3L		BPR8ES	3923			BPR8EIX	6684					.024
	H6 3.6L		BCPR7ET	5509									.032
1988-85	H6 3.2L		BPR6ES	7131			BPR6EIX	6637	BPR6EGP	7084	BPR6EY	6427	.028
	H6 3.3L		BPR8ES	3923			BPR8EIX	6684					.024
<b>924</b>													
1988-87	L4 2.5L		BPR6ES	7131			BPR6EIX	6637	BPR6EGP	7084	BPR6EY	6427	.028
<b>928</b>													
1995-93	V8 5.4L		BPR6ES	7131			BPR6EIX	6637	BPR6EGP	7084	BPR6EY	6427	.028
1991-85	V8 5.0L		BPR6ES	7131			BPR6EIX	6637	BPR6EGP	7084	BPR6EY	6427	.028
<b>944</b>													
1991-90	L4 3.0L		BPR6ES	7131			BPR6EIX	6637	BPR6EGP	7084	BPR6EY	6427	.028
1989	L4 2.5L		BPR6ES	7131			BPR6EIX	6637	BPR6EGP	7084	BPR6EY	6427	.028
	L4 2.7L		BPR6ES	7131			BPR6EIX	6637	BPR6EGP	7084	BPR6EY	6427	.028
	L4 3.0L		BPR7ES	5534			BPR7EIX	4055					.028
1988-85	L4 2.5L		BPR6ES	7131			BPR6EIX	6637	BPR6EGP	7084	BPR6EY	6427	.028
<b>968</b>													
1995-92	L4 3.0L		BPR6ES	7131			BPR6EIX	6637	BPR6EGP	7084	BPR6EY	6427	.032
<b>Boxster</b>													
2008-07	H6 2.7L		BKR7EQUP	4285			BKR7EIX	2667					.032
	H6 3.4L		BKR7EQUP	4285			BKR7EIX	2667					.032
2006-05	H6 2.7L		BKR7EQUP	4285			BKR7EIX	2667					.032
	H6 3.2L		BKR7EQUP	4285			BKR7EIX	2667					.032
2004-03	H6 2.7L		BKR6EKUB	7969	FR6AHX-S	94279	BKR6EIX	6418	BKR6EGP	7092	BKR6E	6962	.032
	H6 3.2L		BKR6EKUB	7969	FR6AHX-S	94279	BKR6EIX	6418	BKR6EGP	7092	BKR6E	6962	.032
2002-01	H6 2.7L		BKR6EK	2288	FR6BHX-S	95159	BKR6EIX	6418	BKR6EGP	7092	BKR6E	6962	.032
	H6 3.2L		BKR6EKUB	7969	FR6AHX-S	94279	BKR6EIX	6418	BKR6EGP	7092	BKR6E	6962	.032
2000	H6 2.7L		BKR6EK	2288	FR6BHX-S	95159	BKR6EIX	6418	BKR6EGP	7092	BKR6E	6962	.032
	H6 3.2L		BKR6EK	2288	FR6BHX-S	95159	BKR6EIX	6418	BKR6EGP	7092	BKR6E	6962	.032
1999-97	H6 2.5L		BKR6EK	2288	FR6BHX-S	95159	BKR6EIX	6418	BKR6EGP	7092	BKR6E	6962	.032
<b>Carrera GT</b>													
2005-04	V10 5.7L		BKR6EKUB	7969	FR6AHX-S	94279	BKR6EIX	6418	BKR6EGP	7092	BKR6E	6962	.032
<b>Cayenne</b>													
2017-15	V6 3.0L	ELECTRIC/GAS	<b>PFR8S8EG</b>	<b>94460</b>									.032
	V6 3.6L	Naturally Aspirated	<b>ILZKR8A</b>	<b>94290</b>									.032
2014-12	V6 3.0L	ELECTRIC/GAS	<b>PFR8S8EG</b>	<b>94460</b>									.032

**Bold denotes NGK OE Manufacturer and/or OE Service Part**  
NOT BOLD denotes OE Equivalent Part

**Le texte en gras désigne une pièce d'équipement originale du manufacturier NGK et/ou pièce d'équipement originale de service**  
Le texte non en gras désigne une pièce d'équipement originale équivalente

Note: Due to different operating or engine conditions, alternate heat range plugs may be required.

Note: En raison de différences au niveau du fonctionnement ou des conditions du moteur, d'autres types de bougies avec variation de chaleur peuvent être nécessaires



Year	Cyl. L	Notes	Original Equipment		Ruthenium HX		Iridium IX		G-Power		V-Power		Gap
			Part	Stock	Part	Stock	Part	Stock	Part	Stock	Part	Stock	
<b>PORSCHE (Cont'd)</b>													
<b>Cayenne (Cont'd)</b>													
2014-12	V6 3.6L		<b>ILZKR8A</b>	<b>94290</b>									.032
2011	V6 3.0L	Supercharged	<b>PFR8S8EG</b>	<b>94460</b>									.032
	V6 3.6L		<b>ILZKR8A</b>	<b>94290</b>									.032
2010-08	V6 3.6L		<b>ILZKR7A</b>	<b>1961</b>									.036
2006-04	V6 3.2L		<b>IZKR7B</b>	<b>7563</b>									.036
	V8 4.5L	Naturally Aspirated	BKR6EQUP	3199	FR6BHX-S	95159	BKR6EIX	6418	BKR6EGP	7092	BKR6E	6962	.032
		Turbo	PFR7Q	7963	FR7BHX-S	92400	BKR7EIX	2667					.032
2003	V8 4.5L	Naturally Aspirated	BKR6EQUP	3199	FR6BHX-S	95159	BKR6EIX	6418	BKR6EGP	7092	BKR6E	6962	.032
		Turbo	PFR7Q	7963	FR7BHX-S	92400	BKR7EIX	2667					.032
<b>Cayman</b>													
2008-07	H6 2.7L		BKR7EQUP	4285			BKR7EIX	2667					.032
	H6 3.4L		BKR7EQUP	4285			BKR7EIX	2667					.032
2006	H6 3.4L		BKR7EQUP	4285			BKR7EIX	2667					.032
<b>Panamera</b>													
2016-14	V6 3.0L	ELECTRIC/GAS	<b>PFR8S8EG</b>	<b>94460</b>									.032
2013-12	V6 3.0L	Supercharged	<b>PFR8S8EG</b>	<b>94460</b>									.032
<b>RAM</b>													
<b>1500</b>													
2017-14	V6 3.6L		SILZKR7B11	9723	LKR7BHX	94705	LKR7DIX-11S	93175	LKR7BGP-S	97390			.044
	V8 5.7L	Dual Plug; 16 Req'd	<b>LZFR5CI-11</b>	<b>92145</b>	LFR5AHX	96355	LFR5AIX-11	4469	LFR5AGP	5018			.044
2013	V6 3.6L		SILZKR7B11	9723	LKR7BHX	94705	LKR7DIX-11S	93175	LKR7BGP-S	97390			.044
	V8 4.7L	Dual Plug; Exhaust Side (8 Req'd)	PLZFR5B13EG	97606			LZFR5AIX-11E	92460	LZFR5AGP-E	90192			.051
		Dual Plug; Intake Side (8 Req'd)	LZFR5C-11	92174			LFR5AIX-11	4469	LFR5AGP	5018			.039
V8 5.7L	Dual Plug; 16 Req'd	<b>LZFR5C-11</b>	<b>92174</b>	LFR5AHX	96355	LFR5AIX-11	4469	LFR5AGP	5018			.044	
2012-11	V6 3.7L		<b>ZFR6F-11G</b>	<b>6987</b>	FR6BHX-S	95159	ZFR6FIX-11	6441	ZFR6FGP	7100	ZFR6F-11G	6987	.044
	V8 4.7L	Dual Plug; Exhaust Side (8 Req'd)	PLZFR5B13EG	97606			LZFR5AIX-11E	92460	LZFR5AGP-E	90192			.051
		Dual Plug; Intake Side (8 Req'd)	LZFR5C-11	92174			LFR5AIX-11	4469	LFR5AGP	5018			.039
V8 5.7L	Dual Plug; 16 Req'd	<b>LZFR5C-11</b>	<b>92174</b>	LFR5AHX	96355	LFR5AIX-11	4469	LFR5AGP	5018			.044	
<b>2500</b>													
2018	V8 6.4L	Dual Plug; 16 Req'd	ILFR5T11	96779	LFR5AHX	96355	LFR5AIX-11	4469	LFR5AGP	5018	LFR5A-11	6376	.044
2017	V8 5.7L	CNG, Dual Plug; 16 Req'd			LFR5AHX	96355							.032
		GAS, Dual Plug; 16 Req'd	<b>LZFR5CI-11</b>	<b>92145</b>			LFR5AIX-11	4469	LFR5AGP	5018			.044
	V8 6.4L	Dual Plug; 16 Req'd	ILFR5T11	96779	LFR5AHX	96355	LFR5AIX-11	4469	LFR5AGP	5018	LFR5A-11	6376	.044
2016-14	V8 5.7L	GAS, Dual Plug; 16 Req'd	<b>LZFR5CI-11</b>	<b>92145</b>	LFR5AHX	96355	LFR5AIX-11	4469	LFR5AGP	5018			.044
	V8 6.4L	Dual Plug; 16 Req'd	ILFR5T11	96779	LFR5AHX	96355	LFR5AIX-11	4469	LFR5AGP	5018	LFR5A-11	6376	.044
2013-11	V8 5.7L	Dual Plug; 16 Req'd	<b>LZFR5C-11</b>	<b>92174</b>	LFR5AHX	96355	LFR5AIX-11	4469	LFR5AGP	5018			.044
<b>3500</b>													
2018	V8 6.4L	Dual Plug; 16 Req'd	ILFR5T11	96779	LFR5AHX	96355	LFR5AIX-11	4469	LFR5AGP	5018	LFR5A-11	6376	.044
2017-15	V8 5.7L	Dual Plug; 16 Req'd	<b>LZFR5CI-11</b>	<b>92145</b>	LFR5AHX	96355	LFR5AIX-11	4469	LFR5AGP	5018			.044
	V8 6.4L	Dual Plug; 16 Req'd	ILFR5T11	96779	LFR5AHX	96355	LFR5AIX-11	4469	LFR5AGP	5018	LFR5A-11	6376	.044
2014	V8 5.7L	GAS, Dual Plug; 16 Req'd	<b>LZFR5CI-11</b>	<b>92145</b>	LFR5AHX	96355	LFR5AIX-11	4469	LFR5AGP	5018			.044
	V8 6.4L	Dual Plug; 16 Req'd	ILFR5T11	96779	LFR5AHX	96355	LFR5AIX-11	4469	LFR5AGP	5018	LFR5A-11	6376	.044
2013-11	V8 5.7L	Dual Plug; 16 Req'd	<b>LZFR5C-11</b>	<b>92174</b>	LFR5AHX	96355	LFR5AIX-11	4469	LFR5AGP	5018			.044
<b>4500</b>													
2017-14	V8 6.4L	Dual Plug; 16 Req'd	ILFR5T11	96779	LFR5AHX	96355	LFR5AIX-11	4469	LFR5AGP	5018	LFR5A-11	6376	.044
<b>5500</b>													
2017-14	V8 6.4L	Dual Plug; 16 Req'd	ILFR5T11	96779	LFR5AHX	96355	LFR5AIX-11	4469	LFR5AGP	5018	LFR5A-11	6376	.044
<b>C/V</b>													
2015-12	V6 3.6L		SILZKR7B11	9723	LKR7BHX	94705	LKR7DIX-11S	93175	LKR7BGP-S	97390			.044
<b>Dakota</b>													
2011	V6 3.7L		<b>ZFR6F-11G</b>	<b>6987</b>	FR6BHX-S	95159	ZFR6FIX-11	6441	ZFR6FGP	7100	ZFR6F-11G	6987	.044



Year	Cyl. L	Notes	Original Equipment		Ruthenium HX		Iridium IX		G-Power		V-Power		Gap
			Part	Stock	Part	Stock	Part	Stock	Part	Stock	Part	Stock	
<b>RAM (Cont'd)</b>													
<b>Dakota (Cont'd)</b>													
2011	V8 4.7L	Dual Plug; Exhaust Side (8 Req'd)	PLZFR5B13EG	97606			LZFR5AIX-11E	92460	LZFR5AGP-E	90192			.051
		Dual Plug; Intake Side (8 Req'd)	LZFR5C-11	92174			LF5AIX-11	4469	LF5AGP	5018			.039
<b>ProMaster 1500</b>													
2017-14	V6 3.6L		SILZKR7B11	9723	LKR7BHX	94705	LKR7DIX-11S	93175	LKR7BGP-S	97390			.044
<b>ProMaster 2500</b>													
2017-14	V6 3.6L		SILZKR7B11	9723	LKR7BHX	94705	LKR7DIX-11S	93175	LKR7BGP-S	97390			.044
<b>ProMaster 3500</b>													
2017-14	V6 3.6L		SILZKR7B11	9723	LKR7BHX	94705	LKR7DIX-11S	93175	LKR7BGP-S	97390			.044
<b>ProMaster City</b>													
2017-15	L4 2.4L		LZFR5CI-11	92145	LF5AHX	96355	LF5AIX-11	4469	LF5AGP	5018			.047
<b>RENAULT</b>													
<b>Alliance</b>													
1987	L4 1.4L		BPR5ES	7734			BPR5EIX	6597	BPR5EGP	7082	BPR5EY	1233	.032
	L4 1.7L		BPR6ES	7131			BPR6EIX	6637	BPR6EGP	7084	BPR6EY	6427	.032
	L4 2.0L		BPR6ES	7131			BPR6EIX	6637	BPR6EGP	7084	BPR6EY	6427	.032
1986-85	L4 1.4L		BPR5ES	7734			BPR5EIX	6597	BPR5EGP	7082	BPR5EY	1233	.032
	L4 1.7L		BPR6ES	7131			BPR6EIX	6637	BPR6EGP	7084	BPR6EY	6427	.032
<b>Encore</b>													
1986-85	L4 1.4L		BPR5ES	7734			BPR5EIX	6597	BPR5EGP	7082	BPR5EY	1233	.032
	L4 1.7L		BPR6ES	7131			BPR6EIX	6637	BPR6EGP	7084	BPR6EY	6427	.032
<b>Fuego</b>													
1985	L4 2.2L		TR5	2238			TR5IX	7397	TR5GP	3186	TR5	2238	.025
<b>LeCar</b>													
1985	L4 2.2L		BPR5ES	7734			BPR5EIX	6597	BPR5EGP	7082	BPR5EY	1233	.032
<b>R5</b>													
1986	L4 2.2L		BPR6ES	7131			BPR6EIX	6637	BPR6EGP	7084	BPR6EY	6427	.025
<b>R18i</b>													
1986-85	L4 2.2L		TR5	2238			TR5IX	7397	TR5GP	3186	TR5	2238	.025
<b>ROLLS-ROYCE</b>													
<b>Camargue</b>													
1987-85	V8 6.8L						GR4IX	97382	GR4GP	2763	GR4	2635	.035
<b>Corniche</b>													
2002	V8 6.8L		BKR5EIX	6341			BKR5EIX	6341					.032
2001	V8 6.8L		BKR5E	7938	FR5BHX	96457			BKR5EGP	7090	BKR5E	7938	.032
2000	V8 6.8L		BKR5E	7938	FR5BHX	96457	BKR5EIX	6341	BKR5EGP	7090	BKR5E	7938	.032
1985	V8 6.8L		<b>BPR5EGP</b>	<b>7082</b>			BPR5EIX	6597	BPR5EGP	7082			.035
<b>Corniche II</b>													
1992-88	V8 6.8L		<b>BPR5EGP</b>	<b>7082</b>			BPR5EIX	6597	BPR5EGP	7082			.040
1987-86	V8 6.8L		<b>BPR5EGP</b>	<b>7082</b>			BPR5EIX	6597	BPR5EGP	7082			.035
<b>Corniche IV</b>													
1995-94	V8 6.8L		BKR4EIX	5693			BKR4EIX	5693			BKR4E-11	5424	.035
1993	V8 6.8L						BKR4EIX	5693			BKR4E-11	5424	.040
<b>Corniche S</b>													
1995	V8 6.8L		BKR4EIX	5693			BKR4EIX	5693			BKR4E-11	5424	.035
<b>Flying Spur</b>													
1995	V8 6.8L		BKR4EIX	5693			BKR4EIX	5693			BKR4E-11	5424	.035
<b>Park Ward</b>													
2002	V12 5.4L		<b>BKR6EQUP</b>	<b>3199</b>	FR6AHX-S	94279	BKR6EIX	6418	BKR6EGP	7092	BKR6E	6962	.032
<b>Phantom</b>													
2013-04	V12 6.7L		<b>BKR6EQUP</b>	<b>3199</b>	FR6BHX-S	95159	BKR6EIX	6418	BKR6EGP	7092	BKR6E	6962	.032
<b>Silver Dawn</b>													
1997	V8 6.8L		BKR5EIX	6341	FR5BHX	96457	BKR5EIX	6341	BKR5EGP	7090	BKR5E	7938	.036
1996-95	V8 6.8L		BKR5EIX	6341			BKR5EIX	6341	BKR5EGP	7090	BKR5E	7938	.036
<b>Silver Seraph</b>													
2002-99	V12 5.4L		<b>BKR6EQUP</b>	<b>3199</b>	FR6AHX-S	94279	BKR6EIX	6418	BKR6EGP	7092	BKR6E	6962	.032

**Bold denotes NGK OE Manufacturer and/or OE Service Part**  
NOT BOLD denotes OE Equivalent Part

**Le texte en gras désigne une pièce d'équipement originale du manufacturier NGK et/ou pièce d'équipement originale de service**  
Le texte non en gras désigne une pièce d'équipement originale équivalente

Note: Due to different operating or engine conditions, alternate heat range plugs may be required.

Note: En raison de différences au niveau du fonctionnement ou des conditions du moteur, d'autres types de bougies avec variation de chaleur peuvent être nécessaires



Year	Cyl. L	Notes	Original Equipment		Ruthenium HX		Iridium IX		G-Power		V-Power		Gap
			Part	Stock	Part	Stock	Part	Stock	Part	Stock	Part	Stock	
<b>ROLLS-ROYCE (Cont'd)</b>													
Silver Spirit													
1995-92	V8 6.8L		BKR4EIX	5693			BKR4EIX	5693			BKR4E-11	5424	.035
1991-87	V8 6.8L		<b>BPR5EGP</b>	<b>7082</b>			BPR5EIX	6597	BPR5EGP	7082			.040
1986-85	V8 6.8L						GR4IX	97382	GR4GP	2763	GR4	2635	.035
Silver Spur													
1998-92	V8 6.8L		BKR4EIX	5693			BKR4EIX	5693			BKR4E-11	5424	.035
1991-87	V8 6.8L		<b>BPR5EGP</b>	<b>7082</b>			BPR5EIX	6597	BPR5EGP	7082			.040
1986-85	V8 6.8L						GR4IX	97382	GR4GP	2763	GR4	2635	.035
Touring Limousine													
1994	V8 6.8L		BKR4EIX	5693			BKR4EIX	5693			BKR4E-11	5424	.035
<b>SAAB</b>													
9-2X													
2006	H4 2.5L	Naturally Aspirated	<b>FR5AP-11</b>	<b>5463</b>	FR5BHX	96457	BKR5EIX-11	5464	BKR5EGP	7090	BKR5E-11	6953	.044
		Turbo	<b>ILFR6B</b>	<b>6481</b>	LF6BHX	93420	LF6AIX	93893	LF6CGP	1483			.030
2005	H4 2.0L		<b>PFR6G</b>	<b>4793</b>	FR6BHX-S	95159	BKR6EIX	6418	BKR6EGP	7092	BKR6E	6962	.030
	H4 2.5L		<b>FR5AP-11</b>	<b>5463</b>	FR5BHX	96457	BKR5EIX-11	5464	BKR5EGP	7090	BKR5E	7938	.044
9-3													
2011-10	L4 2.0L		<b>PFR6T-10G</b>	<b>5542</b>	FR6BHX-S	95159	BKR6EIX-11	3764	BKR6EGP	7092			.039
2009-06	L4 2.0L		<b>PFR6T-10G</b>	<b>5542</b>	FR6BHX-S	95159	BKR6EIX-11	3764	BKR6EGP	7092			.039
	V6 2.8L		<b>PLFR6C-10G</b>	<b>1959</b>	LF6BHX	93420	LF6AIX-11	6619	LF6CGP	1483	LF6C-11	7787	.040
2005-04	L4 2.0L		<b>PFR6T-10G</b>	<b>5542</b>	FR6BHX-S	95159	BKR6EIX-11	3764	BKR6EGP	7092			.039
2003	L4 2.0L		<b>PFR6H-10</b>	<b>6290</b>			BCPR6EIX-11	4919	BCPR6EGP	7088	BCPR6E	3735	.039
2002-00	L4 2.0L		<b>PFR6H-10</b>	<b>6290</b>			BCPR6EIX-11	4919	BCPR6EGP	7088	BCPR6E	3735	.039
	L4 2.3L		<b>PFR6H-10</b>	<b>6290</b>			BCPR6EIX-11	4919	BCPR6EGP	7088	BCPR6E	3735	.039
1999	L4 2.0L		<b>BCPR7ES-11</b>	<b>1095</b>			BCPR7EIX-11	5691					.039
	L4 2.3L		<b>PFR6H-10</b>	<b>6290</b>			BCPR6EIX-11	4919	BCPR6EGP	7088	BCPR6E	3735	.039
9-3X													
2011-10	L4 2.0L		<b>PFR6T-10G</b>	<b>5542</b>	FR6BHX-S	95159	BKR6EIX-11	3764	BKR6EGP	7092			.039
9-4X													
2011	V6 2.8L		<b>DILFR7B10G</b>	<b>97218</b>									.040
	V6 3.0L		<b>ILTR6E11</b>	<b>90117</b>	LTR6AHX	91276	LTR6IX-11	6509	LTR6GP	90198			.044
9-5													
2011	L4 2.0L		<b>ILTR5D</b>	<b>5476</b>			LTR5IX-11	4344	LTR5GP	5019			.036
	V6 2.8L		<b>DILFR7B10G</b>	<b>97218</b>									.040
2010	V6 2.8L		<b>DILFR7B10G</b>	<b>97218</b>									.040
2009-06	L4 2.3L		<b>PFR6H-10</b>	<b>6290</b>			BCPR6EIX-11	4919	BCPR6EGP	7088	BCPR6E	3735	.039
2005-04	L4 2.3L	Eng Desg B235E	<b>BCPR6E-11</b>	<b>5632</b>			BCPR6EIX-11	4919	BCPR6EGP	7088	BCPR6E-11	5632	.039
		Eng Desg B235L	<b>PFR6H-10</b>	<b>6290</b>			BCPR6EIX-11	4919	BCPR6EGP	7088	BCPR6E	3735	.039
		Eng Desg B235R	<b>PFR6H-10</b>	<b>6290</b>			BCPR6EIX-11	4919	BCPR6EGP	7088	BCPR6E	3735	.039
2003	L4 2.3L		<b>PFR6H-10</b>	<b>6290</b>			BCPR6EIX-11	4919	BCPR6EGP	7088	BCPR6E-11	5632	.039
	V6 3.0L		<b>BKR7ES-11</b>	<b>4952</b>			BKR7EIX-11	6988			BKR7E-11	5791	.039
2002-00	L4 2.3L	Eng Desg B235E	<b>BCPR6E-11</b>	<b>5632</b>			BCPR6EIX-11	4919	BCPR6EGP	7088	BCPR6E-11	5632	.039
		Eng Desg B235R	<b>PFR6H-10</b>	<b>6290</b>			BCPR6EIX-11	4919	BCPR6EGP	7088	BCPR6E	3735	.039
	V6 3.0L		<b>BKR7ES-11</b>	<b>4952</b>			BKR7EIX-11	6988			BKR7E-11	5791	.039
1999	L4 2.3L		<b>BCPR6E-11</b>	<b>5632</b>			BCPR6EIX-11	4919	BCPR6EGP	7088	BCPR6E-11	5632	.039
	V6 3.0L		<b>BKR7ES-11</b>	<b>4952</b>			BKR7EIX-11	6988			BKR7E-11	5791	.039
9-7x													
2009-08	L6 4.2L		<b>ILTR5E11</b>	<b>91418</b>	LTR5AHX	90220	LTR5IX-11	4344	LTR5GP	5019			.044
	V8 5.3L		IZTR5B11	1465	TR5AHX	94567	TR5IX	7397	TR5GP	3186	TR5	2238	.040
	V8 6.0L		IZTR5B11	1465	TR5AHX	94567	TR5IX	7397	TR5GP	3186	TR5	2238	.040
2007-05	L6 4.2L		<b>ILTR5E11</b>	<b>91418</b>	LTR5AHX	90220	LTR5IX-11	4344	LTR5GP	5019			.044
	V8 5.3L		IZTR5B11	1465	TR5AHX	94567	TR5IX	7397	TR5GP	3186	TR5	2238	.040
900													
1998	L4 2.0L		<b>BCPR7ES-11</b>	<b>1095</b>			BCPR7EIX-11	5691					.040
	L4 2.3L		<b>BCPR6ES</b>	<b>2330</b>			BCPR6EIX	5689	BCPR6EGP	7088	BCPR6E	3735	.024
1997	L4 2.0L		<b>BCPR7ES-11</b>	<b>1095</b>			BCPR7EIX-11	5691					.040
	L4 2.3L		<b>BCPR6ES</b>	<b>2330</b>			BCPR6EIX	5689	BCPR6EGP	7088	BCPR6E	3735	.024
	V6 2.5L		<b>BKR6EK</b>	<b>2288</b>	FR6BHX-S	95159	BKR6EIX	6418	BKR6EGP	7092	BKR6E	6962	.032



Year	Cyl. L	Notes	Original Equipment		Ruthenium HX		Iridium IX		G-Power		V-Power		Gap
			Part	Stock	Part	Stock	Part	Stock	Part	Stock	Part	Stock	
<b>SAAB (Cont'd)</b>													
<b>900 (Cont'd)</b>													
1996-95	L4 2.0L		<b>BCPR7ES-11</b>	<b>1095</b>			BCPR7EIX-11	5691					.044
	L4 2.3L		<b>BCPR6ES</b>	<b>2330</b>			BCPR6EIX	5689	BCPR6EGP	7088	BCPR6E	3735	.024
	V6 2.5L		<b>BKR6EK</b>	<b>2288</b>			BKR6EIX	6418	BKR6EGP	7092	BKR6E	6962	.032
1994	L4 2.0L	Eng Desg B202L, City Driving	<b>BCPR6ES</b>	<b>2330</b>			BCPR6EIX	5689	BCPR6EGP	7088	BCPR6E	3735	.024
		Eng Desg B202L, Hard Driving	BCPR7EIX	5690			BCPR7EIX	5690					.024
		Eng Desg B202R, City Driving	<b>BCPR6ES</b>	<b>2330</b>			BCPR6EIX	5689	BCPR6EGP	7088	BCPR6E	3735	.028
		Eng Desg B202R, Hard Driving	BCPR7EIX	5690			BCPR7EIX	5690					.028
		Eng Desg B204L	<b>BCPR7ES-11</b>	<b>1095</b>			BCPR7EIX-11	5691					.040
	L4 2.1L		<b>BCPR5EGP</b>	<b>7086</b>			BCPR5EIX	5688	BCPR5EGP	7086	BCPR5EY	1266	.028
	L4 2.3L		<b>BCPR6ES</b>	<b>2330</b>			BCPR6EIX	5689	BCPR6EGP	7088	BCPR6E	3735	.024
V6 2.5L	SE	<b>BKR6EK</b>	<b>2288</b>			BKR6EIX	6418	BKR6EGP	7092	BKR6E	6962	.032	
1993	L4 2.0L	City Driving	BCPR6ES	2330			BCPR6EIX	5689	BCPR6EGP	7088	BCPR6E	3735	.028
		Hard Driving	<b>BCPR7EIX</b>	<b>5690</b>			BCPR7EIX	5690				.028	
L4 2.1L		<b>BCPR5EGP</b>	<b>7086</b>			BCPR5EIX	5688	BCPR5EGP	7086	BCPR5EY	1266	.028	
1992	L4 2.0L	City Driving	BCPR6ES	2330			BCPR6EIX	5689	BCPR6EGP	7088	BCPR6E	3735	.028
		Hard Driving	BCPR7EIX	5690			BCPR7EIX	5690				.028	
L4 2.1L		<b>BCPR5EGP</b>	<b>7086</b>			BCPR5EIX	5688	BCPR5EGP	7086	BCPR5EY	1266	.028	
1991	L4 2.0L	City Driving	BCPR6ES	2330			BCPR6EIX	5689	BCPR6EGP	7088	BCPR6E	3735	.028
		Hard Driving	BCPR7EIX	5690			BCPR7EIX	5690				.028	
	L4 2.1L					BCPR5EIX	5688				.028		
1990	L4 2.0L	Eng Desg B202I, City Driving	BCPR6ES	2330			BCPR6EIX	5689	BCPR6EGP	7088	BCPR6E	3735	.032
		Eng Desg B202I, Hard Driving	BCPR7ES	6282			BCPR7EIX	5690				.028	
		Eng Desg B202L, City Driving	BCPR6ES	2330			BCPR6EIX	5689	BCPR6EGP	7088	BCPR6E	3735	.028
		Eng Desg B202L, Hard Driving	BCPR7EIX	5690			BCPR7EIX	5690				.028	
1989	L4 2.0L		BCPR6ES	2330			BCPR6EIX	5689	BCPR6EGP	7088	BCPR6E	3735	.028
1988	L4 2.0L	Eng Desg B201I, City Driving	BCPR6ES	2330			BCPR6EIX	5689	BCPR6EGP	7088	BCPR6E	3735	.032
		Eng Desg B201I, Hard Driving	BCPR7ES	6282			BCPR7EIX	5690				.028	
		Eng Desg B202I, City Driving	BCPR6ES	2330			BCPR6EIX	5689	BCPR6EGP	7088	BCPR6E	3735	.028
		Eng Desg B202I, Hard Driving	BCPR7EIX	5690			BCPR7EIX	5690				.028	
1987	L4 2.0L	Vin D	BCPR6ES	2330			BCPR6EIX	5689	BCPR6EGP	7088	BCPR6E	3735	.032
		Vin J, City Driving	BCPR6ES	2330			BCPR6EIX	5689	BCPR6EGP	7088	BCPR6E	3735	.032
		Vin J, Hard Driving	BCPR7ES	6282			BCPR7EIX	5690				.028	
		Vin L, City Driving	BCPR6ES	2330			BCPR6EIX	5689	BCPR6EGP	7088	BCPR6E	3735	.028
		Vin L, Hard Driving	BCPR7EIX	5690			BCPR7EIX	5690				.028	
1986	L4 2.0L	Eng Desg B201I, City Driving	BCPR6ES	2330			BCPR6EIX	5689	BCPR6EGP	7088	BCPR6E	3735	.032
		Eng Desg B201I, Hard Driving	BCPR7ES	6282			BCPR7EIX	5690				.028	
		Eng Desg B202I	<b>BPR6ES</b>	<b>7131</b>			BPR6EIX	6637	BPR6EGP	7084	BPR6EY	6427	.028
		Eng Desg B202L, City Driving	BCPR6ES	2330			BCPR6EIX	5689	BCPR6EGP	7088	BCPR6E	3735	.028
		Eng Desg B202L, Hard Driving	BCPR7EIX	5690			BCPR7EIX	5690				.028	
1985	L4 2.0L	Eng Desg B201I, City Driving	BCPR6ES	2330			BCPR6EIX	5689	BCPR6EGP	7088	BCPR6E	3735	.032
		Eng Desg B201I, Hard Driving	BCPR7ES	6282			BCPR7EIX	5690				.028	
		Eng Desg B202L, City Driving	BCPR6ES	2330			BCPR6EIX	5689	BCPR6EGP	7088	BCPR6E	3735	.028
		Eng Desg B202L, Hard Driving	BCPR7EIX	5690			BCPR7EIX	5690				.028	

**Bold denotes NGK OE Manufacturer and/or OE Service Part**  
 NOT BOLD denotes OE Equivalent Part

Note: Due to different operating or engine conditions, alternate heat range plugs may be required.

**Le texte en gras désigne une pièce d'équipement originale du manufacturier NGK et/ou pièce d'équipement originale de service**  
 Le texte non en gras désigne une pièce d'équipement originale équivalente

Note: En raison de différences au niveau du fonctionnement ou des conditions du moteur, d'autres types de bougies avec variation de chaleur peuvent être nécessaires





Year	Cyl. L	Notes	Original Equipment		Ruthenium HX		Iridium IX		G-Power		V-Power		Gap
			Part	Stock	Part	Stock	Part	Stock	Part	Stock	Part	Stock	
<b>SAAB (Cont'd)</b>													
<b>9000</b>													
1998	L4 2.3L		<b>BCPR7ES-11</b>	<b>1095</b>			BCPR7EIX-11	5691					.039
1997	L4 2.3L		<b>BCPR7ES-11</b>	<b>1095</b>			BCPR7EIX-11	5691					.039
	V6 3.0L		<b>BKR6EK</b>	<b>2288</b>	FR6BHX-S	95159	BKR6EIX	6418	BKR6EGP	7092	BKR6E	6962	.032
1996-95	L4 2.3L		<b>BCPR7ES-11</b>	<b>1095</b>			BCPR7EIX-11	5691					.039
	V6 3.0L		<b>BKR6EK</b>	<b>2288</b>			BKR6EIX	6418	BKR6EGP	7092	BKR6E	6962	.032
1994-93	L4 2.3L	Naturally Aspirated	<b>BCPR6ES-11</b>	<b>6779</b>			BCPR6EIX-11	4919	BCPR6EGP	7088	BCPR6E-11	5632	.039
		Turbo	<b>BCPR7ES-11</b>	<b>1095</b>			BCPR7EIX-11	5691					.044
1992-91	L4 2.3L	Naturally Aspirated	<b>BCPR6ES-11</b>	<b>6779</b>			BCPR6EIX-11	4919	BCPR6EGP	7088	BCPR6E-11	5632	.039
		Turbo	<b>BCPR7ES-11</b>	<b>1095</b>			BCPR7EIX-11	5691					.039
1990	L4 2.0L	Naturally Aspirated, City Driving	BCPR6ES	2330			BCPR6EIX	5689	BCPR6EGP	7088	BCPR6E	3735	.032
		Naturally Aspirated, Hard Driving	BCPR7ES	6282			BCPR7EIX	5690					.028
		Turbo	<b>BCPR7ES-11</b>	<b>1095</b>			BCPR7EIX-11	5691					.044
	L4 2.3L		<b>BCPR7ES-11</b>	<b>1095</b>			BCPR7EIX-11	5691					.039
1989	L4 2.0L	Naturally Aspirated, City Driving	BCPR6ES	2330			BCPR6EIX	5689	BCPR6EGP	7088	BCPR6E	3735	.032
		Naturally Aspirated, Hard Driving	BCPR7ES	6282			BCPR7EIX	5690					.028
		Turbo	<b>BCPR7ES-11</b>	<b>1095</b>			BCPR7EIX-11	5691					.044
1988-87	L4 2.0L	Eng Desg B202I, City Driving	BCPR6ES	2330			BCPR6EIX	5689	BCPR6EGP	7088	BCPR6E	3735	.032
		Eng Desg B202I, Hard Driving	BCPR7ES	6282			BCPR7EIX	5690					.028
		Eng Desg B202L, City Driving	BCPR6ES	2330			BCPR6EIX	5689	BCPR6EGP	7088	BCPR6E	3735	.028
		Eng Desg B202L, Hard Driving	BCPR7ES	6282			BCPR7EIX	5690					.028
1986	L4 2.0L	City Driving	BCPR6ES	2330			BCPR6EIX	5689	BCPR6EGP	7088	BCPR6E	3735	.028
		Hard Driving	BCPR7ES	6282			BCPR7EIX	5690					.028
<b>SATURN</b>													
<b>Astra</b>													
2009-08	L4 1.8L		ZFR5F	7558	FR5AHX	95839	ZFR5FIX-11	2477	ZFR5FGP	7098	ZFR5F	7558	.028
<b>Aura</b>													
2010	L4 2.4L		<b>ILTR5E11</b>	<b>91418</b>	LTR5AHX	90220	LTR5IX-11	4344	LTR5GP	5019			.044
2009	L4 2.4L		<b>ILTR5E11</b>	<b>91418</b>	LTR5AHX	90220	LTR5IX-11	4344	LTR5GP	5019			.044
	V6 3.6L		PLTR6A-10G	3587	LTR6AHX	91276	LTR6IX-11	6509	LTR6GP	90198			.044
2008-07	L4 2.4L		<b>ILTR5B11</b>	<b>3474</b>	LTR5AHX	90220	LTR5IX-11	4344	LTR5GP	5019			.044
	V6 3.5L		<b>IZTR4A11</b>	<b>4213</b>			TR4IX	7300	TR4GP	2815	TR4	3754	.044
	V6 3.6L		PLTR6A-10G	3587	LTR6AHX	91276	LTR6IX-11	6509	LTR6GP	90198			.044
<b>Ion</b>													
2007	L4 2.0L		<b>IFR6V-10G</b>	<b>92085</b>	FR6BHX-S	95159	BKR6EIX	6418	BKR6EGP	7092	BKR6E	6962	.040
	L4 2.2L		<b>ILTR5C11</b>	<b>5581</b>	LTR5AHX	90220	LTR5IX-11	4344	LTR5GP	5019			.044
	L4 2.4L		<b>ILTR5B11</b>	<b>3474</b>	LTR5AHX	90220	LTR5IX-11	4344	LTR5GP	5019			.044
2006	L4 2.0L		<b>IFR6V-10G</b>	<b>92085</b>	FR6BHX-S	95159	BKR6EIX	6418	BKR6EGP	7092	BKR6E	6962	.040
	L4 2.2L		<b>ILTR5C11</b>	<b>5581</b>			LTR5IX-11	4344	LTR5GP	5019			.044
	L4 2.4L		<b>ILTR5B11</b>	<b>3474</b>	LTR5AHX	90220	LTR5IX-11	4344	LTR5GP	5019			.044
2005-04	L4 2.0L		<b>IFR6V-10G</b>	<b>92085</b>	FR6BHX-S	95159	BKR6EIX	6418	BKR6EGP	7092	BKR6E	6962	.040
	L4 2.2L		<b>ILTR5C11</b>	<b>5581</b>			LTR5IX-11	4344	LTR5GP	5019			.044
2003	L4 2.2L		<b>ILTR5C11</b>	<b>5581</b>			LTR5IX-11	4344	LTR5GP	5019			.044
<b>L100</b>													
2002-01	L4 2.2L		<b>ILTR5C11</b>	<b>5581</b>			LTR5IX-11	4344	LTR5GP	5019			.044
<b>L200</b>													
2003-01	L4 2.2L		<b>ILTR5C11</b>	<b>5581</b>			LTR5IX-11	4344	LTR5GP	5019			.044
<b>L300</b>													
2005	V6 3.0L		BKR5EK	7797	FR5AHX	95839	BKR5EIX	6341	BKR5EGP	7090	BKR5E	7938	.040
2004	L4 2.2L		<b>ILTR5C11</b>	<b>5581</b>			LTR5IX-11	4344	LTR5GP	5019			.044
	V6 3.0L		BKR5EK	7797	FR5AHX	95839	BKR5EIX	6341	BKR5EGP	7090	BKR5E	7938	.040
2003-01	V6 3.0L		BKR5EK	7797	FR5AHX	95839	BKR5EIX	6341	BKR5EGP	7090	BKR5E	7938	.040



Year	Cyl. L	Notes	Original Equipment		Ruthenium HX		Iridium IX		G-Power		V-Power		Gap
			Part	Stock	Part	Stock	Part	Stock	Part	Stock	Part	Stock	
<b>SATURN (Cont'd)</b>													
<b>LS</b>													
2000	L4 2.2L		<b>ILTR5C11</b>	<b>5581</b>			LTR5IX-11	4344	LTR5GP	5019			.044
<b>LS1</b>													
2000	L4 2.2L		<b>ILTR5C11</b>	<b>5581</b>			LTR5IX-11	4344	LTR5GP	5019			.044
<b>LS2</b>													
2000	V6 3.0L		BKR5EK	7797	FR5AHX	95839	BKR5EIX	6341	BKR5EGP	7090	BKR5E	7938	.040
<b>LW1</b>													
2000	L4 2.2L		<b>ILTR5C11</b>	<b>5581</b>			LTR5IX-11	4344	LTR5GP	5019			.044
<b>LW2</b>													
2000	V6 3.0L		BKR5EK	7797	FR5AHX	95839	BKR5EIX	6341	BKR5EGP	7090	BKR5E	7938	.040
<b>LW200</b>													
2003-01	L4 2.2L		<b>ILTR5C11</b>	<b>5581</b>			LTR5IX-11	4344	LTR5GP	5019			.044
<b>LW300</b>													
2003-01	V6 3.0L		BKR5EK	7797	FR5AHX	95839	BKR5EIX	6341	BKR5EGP	7090	BKR5E	7938	.040
<b>Outlook</b>													
2010-07	V6 3.6L		<b>ILTR6E11</b>	<b>90117</b>	LTR6AHX	91276	LTR6IX-11	6509	LTR6GP	90198			.044
<b>Relay</b>													
2007	V6 3.9L		<b>IZTR4A11</b>	<b>4213</b>			TR4IX	7300	TR4GP	2815	TR4	3754	.044
2006	V6 3.5L		<b>ITR4A15</b>	<b>5599</b>	TR4BHX	97100	TR55IX	7164	TR55GP	3403	TR55	3951	.060
	V6 3.9L		<b>IZTR4A11</b>	<b>4213</b>			TR4IX	7300	TR4GP	2815	TR4	3754	.044
2005	V6 3.5L		<b>ITR4A15</b>	<b>5599</b>	TR4BHX	97100	TR55IX	7164	TR55GP	3403	TR55	3951	.060
<b>SC</b>													
1992-91	L4 1.9L	DOHC	<b>BKR5ESA-11</b>	<b>5643</b>			BKR5EIX-11	5464	BKR5EGP	7090	BKR5E-11	6953	.040
<b>SC1</b>													
2002-93	L4 1.9L	SOHC	<b>BKR4ESA-11</b>	<b>7755</b>			BKR4EIX	5693			BKR4E-11	5424	.040
<b>SC2</b>													
2002-97	L4 1.9L	DOHC	<b>BKR5ESA-11</b>	<b>5643</b>	FR5BHX	96457	BKR5EIX-11	5464	BKR5EGP	7090	BKR5E-11	6953	.040
1996-93	L4 1.9L	DOHC	<b>BKR5ESA-11</b>	<b>5643</b>			BKR5EIX-11	5464	BKR5EGP	7090	BKR5E-11	6953	.040
<b>Sky</b>													
2010-09	L4 2.0L		<b>ILTR5D</b>	<b>5476</b>			LTR5IX-11	4344	LTR5GP	5019			.036
	L4 2.4L		<b>ILTR5E11</b>	<b>91418</b>	LTR5AHX	90220	LTR5IX-11	4344	LTR5GP	5019			.044
2008-07	L4 2.0L		<b>ILTR5D</b>	<b>5476</b>			LTR5IX-11	4344	LTR5GP	5019			.036
	L4 2.4L		<b>ILTR5B11</b>	<b>3474</b>	LTR5AHX	90220	LTR5IX-11	4344	LTR5GP	5019			.044
<b>SL</b>													
2002-91	L4 1.9L	SOHC	<b>BKR4ESA-11</b>	<b>7755</b>			BKR4EIX	5693			BKR4E-11	5424	.040
<b>SL1</b>													
2002-91	L4 1.9L	SOHC	<b>BKR4ESA-11</b>	<b>7755</b>			BKR4EIX	5693			BKR4E-11	5424	.040
<b>SL2</b>													
2002-97	L4 1.9L	DOHC	<b>BKR5ESA-11</b>	<b>5643</b>	FR5BHX	96457	BKR5EIX-11	5464	BKR5EGP	7090	BKR5E-11	6953	.040
1996-91	L4 1.9L	DOHC	<b>BKR5ESA-11</b>	<b>5643</b>			BKR5EIX-11	5464	BKR5EGP	7090	BKR5E-11	6953	.040
<b>SW1</b>													
1999-93	L4 1.9L	SOHC	<b>BKR4ESA-11</b>	<b>7755</b>			BKR4EIX	5693			BKR4E-11	5424	.040
<b>SW2</b>													
2001-97	L4 1.9L	DOHC	<b>BKR5ESA-11</b>	<b>5643</b>	FR5BHX	96457	BKR5EIX-11	5464	BKR5EGP	7090	BKR5E-11	6953	.040
1996-93	L4 1.9L	DOHC	<b>BKR5ESA-11</b>	<b>5643</b>			BKR5EIX-11	5464	BKR5EGP	7090	BKR5E-11	6953	.040
<b>Vue</b>													
2010	L4 2.4L		<b>ILTR5B11</b>	<b>3474</b>	LTR5AHX	90220	LTR5IX-11	4344	LTR5GP	5019			.044
	V6 3.5L		<b>IZTR4A11</b>	<b>4213</b>			TR4IX	7300	TR4GP	2815	TR4	3754	.044
	V6 3.6L		<b>ILTR6E11</b>	<b>90117</b>	LTR6AHX	91276	LTR6IX-11	6509	LTR6GP	90198			.044
2009-08	L4 2.4L		<b>ILTR5B11</b>	<b>3474</b>	LTR5AHX	90220	LTR5IX-11	4344	LTR5GP	5019			.044
	V6 3.5L		<b>IZTR4A11</b>	<b>4213</b>			TR4IX	7300	TR4GP	2815	TR4	3754	.044
	V6 3.6L		PLTR6A-10G	3587	LTR6AHX	91276	LTR6IX-11	6509	LTR6GP	90198			.044
2007	L4 2.2L		<b>ILTR5E11</b>	<b>91418</b>	LTR5AHX	90220	LTR5IX-11	4344	LTR5GP	5019			.044
	L4 2.4L		<b>ILTR5B11</b>	<b>3474</b>	LTR5AHX	90220	LTR5IX-11	4344	LTR5GP	5019			.044
	V6 3.5L		IZFR5K11	3657			ZFR5AIX-11	94553	ZFR5BGP	90804			.044
2006-04	L4 2.2L		<b>ILTR5C11</b>	<b>5581</b>			LTR5IX-11	4344	LTR5GP	5019			.044
	V6 3.5L		IZFR5K11	3657			ZFR5AIX-11	94553	ZFR5BGP	90804			.044
2003-02	L4 2.2L		<b>ILTR5C11</b>	<b>5581</b>			LTR5IX-11	4344	LTR5GP	5019			.044

**Bold denotes NGK OE Manufacturer and/or OE Service Part**  
NOT BOLD denotes OE Equivalent Part

**Le texte en gras désigne une pièce d'équipement originale du manufacturier NGK et/ou pièce d'équipement originale de service**  
Le texte non en gras désigne une pièce d'équipement originale équivalente

Note: Due to different operating or engine conditions, alternate heat range plugs may be required.

Note: En raison de différences au niveau du fonctionnement ou des conditions du moteur, d'autres types de bougies avec variation de chaleur peuvent être nécessaires



Year	Cyl. L	Notes	Original Equipment		Ruthenium HX		Iridium IX		G-Power		V-Power		Gap
			Part	Stock	Part	Stock	Part	Stock	Part	Stock	Part	Stock	
<b>SATURN (Cont'd)</b>													
Vue (Cont'd)													
2003-02	V6 3.0L		BKR5EK	7797	FR5AHX	95839	BKR5EIX	6341	BKR5EGP	7090	BKR5E	7938	.040
<b>SCION</b>													
FR-S													
2016-13	H4 2.0L	Racing Plug - Track Use Only	R2558E-9	97537									.031
iA													
2016	L4 1.5L	Sedan	ILKAR7L11	94124	LKAR7AHX-S	92274	LKAR7BIX-11S	93501	LKAR7AGP-D	93220			.040
iQ													
2014	L4 1.3L	To 11/2013	ILKAR7B11	4912	LKAR7AHX-S	92274	LKAR7BIX-11S	93501	LKAR7AGP-D	93220			.044
2013-12	L4 1.3L		ILKAR7B11	4912	LKAR7AHX-S	92274	LKAR7BIX-11S	93501	LKAR7AGP-D	93220			.044
tC													
2016-11	L4 2.5L		ILFR5T11	96779	LFR5AHX	96355	LFR5AIX-11	4469	LFR5AGP	5018	LFR5A-11	6376	.044
2010-05	L4 2.4L		IFR6T11	4589	FR6AHX-S	94279	BKR6EIX-11	3764	BKR6EGP	7092	BKR6E-11	2756	.044
xA													
2006-04	L4 1.5L		BKR5EYA	2087	FR5AHX	95839	BKR5EIX	6341	BKR5EGP	7090	BKR5EYA	2087	.032
xB													
2015-14	L4 2.4L		IFR5T11	4996	FR5AHX	95839	BKR5EIX-11	5464	BKR5EGP	7090	BKR5EYA-11	2526	.044
2013	L4 2.4L	From 6/2012	IFR5T11	4996	FR5AHX	95839	BKR5EIX-11	5464	BKR5EGP	7090	BKR5E-11	6953	.044
2012	L4 2.4L	From 6/2012	IFR5T11	4996	FR5AHX	95839	BKR5EIX-11	5464	BKR5EGP	7090	BKR5E-11	6953	.044
		To 6/2012	IFR6T11	4589	FR6AHX-S	94279	BKR6EIX-11	3764	BKR6EGP	7092	BKR6E-11	2756	.044
2011-08	L4 2.4L		IFR6T11	4589	FR6AHX-S	94279	BKR6EIX-11	3764	BKR6EGP	7092	BKR6E-11	2756	.044
2006-04	L4 1.5L		BKR5EYA	2087	FR5AHX	95839	BKR5EIX	6341	BKR5EGP	7090	BKR5EYA	2087	.032
xD													
2014-08	L4 1.8L		ILKAR7B11	4912	LKAR7AHX-S	92274	LKAR7BIX-11S	93501	LKAR7AGP-D	93220			.044
<b>SMART</b>													
Fortwo													
2015-08	L3 1.0L		<b>LKR7B-9</b>	<b>5847</b>	LKR7BHX	94705	LKR7AIX	93911	LKR7BGP-8	95983			.036
2007-05	L3 0.8L	DIESEL	Y-543J	6600									
<b>SRT</b>													
Viper													
2014-13	V10 8.4L		PLZTR5A-13	4998			LZTR5AIX-13	2314	LZTR5AGP	3381	LZTR5A-13	4306	.050
<b>STERLING</b>													
825													
1988-87	V6 2.5L		BCPR6E-11	5632			BCPR6EIX-11	4919	BCPR6EGP	7088	BCPR6E-11	5632	.040
827													
1991-89	V6 2.7L		BCPR6E-11	5632			BCPR6EIX-11	4919	BCPR6EGP	7088	BCPR6E-11	5632	.040
<b>SUBARU</b>													
B9 Tribeca													
2007-06	H6 3.0L		<b>ILFR6B</b>	<b>6481</b>	LFR6BHX	93420	LFR6AIX	93893	LFR6CGP	1483			.030
Baja													
2006-04	H4 2.5L	Naturally Aspirated	<b>FR5AP-11</b>	<b>5463</b>	FR5BHX	96457	BKR5EIX-11	5464	BKR5EGP	7090	BKR5E-11	6953	.044
		Turbo	<b>ILFR6B</b>	<b>6481</b>	LFR6BHX	93420	LFR6AIX	93893	LFR6CGP	1483			.030
2003	H4 2.5L		<b>BKR6E-11</b>	<b>2756</b>	FR6BHX-S	95159	BKR6EIX-11	3764	BKR6EGP	7092	BKR6E-11	2756	.044
Brat													
1987-85	H4 1.8L		<b>BPR6ES-11</b>	<b>7133</b>			BPR6EIX-11	3903	BPR6EGP	7084	BPR6EY-11	6261	.044
BRZ													
2018-13	H4 2.0L	Racing Plug - Track Use Only	R2558E-9	97537									.031
Crosstrek													
2017	H4 2.0L		<b>SILZKAR7B11</b>	<b>93482</b>	LKAR7AHX-S	92274	LKAR7BIX-11S	93501	LKAR7BGP-S	92649			.044
2016	H4 2.0L	ELECTRIC/GAS	<b>DILZKAR7B11</b>	<b>90935</b>	LKAR7AHX-S	92274							.044
		GAS	<b>SILZKAR7B11</b>	<b>93482</b>	LKAR7AHX-S	92274	LKAR7BIX-11S	93501	LKAR7BGP-S	92649			.044
DL													
1989-85	H4 1.8L		<b>BPR6ES-11</b>	<b>7133</b>			BPR6EIX-11	3903	BPR6EGP	7084	BPR6EY-11	6261	.044
Forester													
2018	H4 2.5L		<b>SILZKAR7B11</b>	<b>93482</b>	LKAR7AHX-S	92274	LKAR7BIX-11S	93501	LKAR7BGP-S	92649			.044
2017-16	H4 2.0L		<b>ILKAR8H6</b>	<b>96024</b>									.024



Year	Cyl. L	Notes	Original Equipment		Ruthenium HX		Iridium IX		G-Power		V-Power		Gap
			Part	Stock	Part	Stock	Part	Stock	Part	Stock	Part	Stock	
<b>SUBARU (Cont'd)</b>													
<b>Forester (Cont'd)</b>													
2017-16	H4 2.5L		<b>SILZKAR7B11</b>	<b>93482</b>	LKAR7AHX-S	92274	LKAR7BIX-11S	93501	LKAR7BGP-S	92649			.044
2015-14	H4 2.0L		<b>ILKAR8H6</b>	<b>96024</b>									.024
	H4 2.5L	Naturally Aspirated	<b>SILZKAR7B11</b>	<b>93482</b>	LKAR7AHX-S	92274	LKAR7BIX-11S	93501	LKAR7BGP-S	92649			.044
2013-11	H4 2.5L	Naturally Aspirated	<b>SILZKAR7B11</b>	<b>93482</b>	LKAR7AHX-S	92274	LKAR7BIX-11S	93501	LKAR7BGP-S	92649			.044
		Turbo	<b>SILFR6A</b>	<b>7913</b>	LFR6BHX	93420	LFR6AIX	93893	LFR6CGP	1483			.030
2010-09	H4 2.5L	Naturally Aspirated	<b>FR5AP-11</b>	<b>5463</b>	FR5BHX	96457	BKR5EIX-11	5464	BKR5EGP	7090	BKR5E-11	6953	.044
		Turbo	<b>SILFR6A</b>	<b>7913</b>	LFR6BHX	93420	LFR6AIX	93893	LFR6CGP	1483			.030
2008-05	H4 2.5L	Naturally Aspirated	<b>FR5AP-11</b>	<b>5463</b>	FR5BHX	96457	BKR5EIX-11	5464	BKR5EGP	7090	BKR5E-11	6953	.044
		Turbo	<b>ILFR6B</b>	<b>6481</b>	LFR6BHX	93420	LFR6AIX	93893	LFR6CGP	1483			.030
2004	H4 2.5L	Naturally Aspirated	<b>BKR6E-11</b>	<b>2756</b>	FR6BHX-S	95159	BKR6EIX-11	3764	BKR6EGP	7092	BKR6E-11	2756	.044
		Turbo	<b>ILFR6B</b>	<b>6481</b>	LFR6BHX	93420	LFR6AIX	93893	LFR6CGP	1483			.030
2003-99	H4 2.5L		<b>BKR6E-11</b>	<b>2756</b>	FR6BHX-S	95159	BKR6EIX-11	3764	BKR6EGP	7092	BKR6E-11	2756	.044
1998	H4 2.5L		<b>PFR5B-11</b>	<b>2300</b>	FR5BHX	96457	BKR5EIX-11	5464	BKR5EGP	7090	BKR5E-11	6953	.044
<b>GL</b>													
1989-88	H4 1.8L		<b>BPR6ES-11</b>	<b>7133</b>			BPR6EIX-11	3903	BPR6EGP	7084	BPR6EY-11	6261	.044
1987	H4 1.6L		<b>BPR6ES-11</b>	<b>7133</b>			BPR6EIX-11	3903	BPR6EGP	7084	BPR6EY-11	6261	.044
	H4 1.8L	Naturally Aspirated	<b>BPR6ES-11</b>	<b>7133</b>			BPR6EIX-11	3903	BPR6EGP	7084	BPR6EY-11	6261	.044
1986	H4 1.6L		<b>BPR6ES-11</b>	<b>7133</b>			BPR6EIX-11	3903	BPR6EGP	7084	BPR6EY-11	6261	.044
	H4 1.8L		<b>BPR6ES-11</b>	<b>7133</b>			BPR6EIX-11	3903	BPR6EGP	7084	BPR6EY-11	6261	.044
1985	H4 1.8L		<b>BPR6ES-11</b>	<b>7133</b>			BPR6EIX-11	3903	BPR6EGP	7084	BPR6EY-11	6261	.044
<b>GL-10</b>													
1989-86	H4 1.8L		<b>BPR6ES-11</b>	<b>7133</b>			BPR6EIX-11	3903	BPR6EGP	7084	BPR6EY-11	6261	.044
1985	H4 1.8L	Naturally Aspirated	<b>BPR6ES-11</b>	<b>7133</b>			BPR6EIX-11	3903	BPR6EGP	7084	BPR6EY-11	6261	.044
<b>Impreza</b>													
2018-17	H4 2.0L	Naturally Aspirated	<b>DILKAR7B8</b>	<b>92217</b>									.032
2016-15	H4 2.0L	Naturally Aspirated	<b>SILZKAR7B11</b>	<b>93482</b>	LKAR7AHX-S	92274	LKAR7BIX-11S	93501	LKAR7BGP-S	92649			.044
2014	H4 2.0L		<b>SILZKAR7B11</b>	<b>93482</b>	LKAR7AHX-S	92274	LKAR7BIX-11S	93501	LKAR7BGP-S	92649			.044
	H4 2.5L	Turbo	<b>SILFR6A</b>	<b>7913</b>	LFR6BHX	93420	LFR6AIX	93893	LFR6CGP	1483			.030
2013-12	H4 2.0L		<b>SILZKAR7B11</b>	<b>93482</b>	LKAR7AHX-S	92274	LKAR7BIX-11S	93501	LKAR7BGP-S	92649			.044
	H4 2.5L		<b>SILFR6A</b>	<b>7913</b>	LFR6BHX	93420	LFR6AIX	93893	LFR6CGP	1483			.030
2011-08	H4 2.5L	Naturally Aspirated	<b>FR5AP-11</b>	<b>5463</b>	FR5BHX	96457	BKR5EIX-11	5464	BKR5EGP	7090	BKR5E-11	6953	.044
		Turbo	<b>SILFR6A</b>	<b>7913</b>	LFR6BHX	93420	LFR6AIX	93893	LFR6CGP	1483			.030
2007-06	H4 2.5L	Naturally Aspirated	<b>FR5AP-11</b>	<b>5463</b>	FR5BHX	96457	BKR5EIX-11	5464	BKR5EGP	7090	BKR5E-11	6953	.044
		Turbo	<b>ILFR6B</b>	<b>6481</b>	LFR6BHX	93420	LFR6AIX	93893	LFR6CGP	1483			.030
2005	H4 2.0L		<b>PFR6G</b>	<b>4793</b>	FR6BHX-S	95159	BKR6EIX	6418	BKR6EGP	7092	BKR6E	6962	.030
	H4 2.5L	Naturally Aspirated	<b>FR5AP-11</b>	<b>5463</b>	FR5BHX	96457	BKR5EIX-11	5464	BKR5EGP	7090	BKR5E-11	6953	.044
		Turbo	<b>ILFR6B</b>	<b>6481</b>	LFR6BHX	93420	LFR6AIX	93893	LFR6CGP	1483			.030
2004	H4 2.0L		<b>PFR6G</b>	<b>4793</b>	FR6BHX-S	95159	BKR6EIX	6418	BKR6EGP	7092	BKR6E	6962	.030
	H4 2.5L	Naturally Aspirated	<b>BKR6E-11</b>	<b>2756</b>	FR6BHX-S	95159	BKR6EIX-11	3764	BKR6EGP	7092	BKR6E-11	2756	.044
		Turbo	<b>ILFR6B</b>	<b>6481</b>	LFR6BHX	93420	LFR6AIX	93893	LFR6CGP	1483			.030
2003-02	H4 2.0L		<b>PFR6G</b>	<b>4793</b>	FR6BHX-S	95159	BKR6EIX	6418	BKR6EGP	7092	BKR6E	6962	.030
	H4 2.5L		<b>BKR6E-11</b>	<b>2756</b>	FR6BHX-S	95159	BKR6EIX-11	3764	BKR6EGP	7092	BKR6E-11	2756	.044
2001-99	H4 2.2L		<b>BKR6E-11</b>	<b>2756</b>	FR6BHX-S	95159	BKR6EIX-11	3764	BKR6EGP	7092	BKR6E-11	2756	.044
	H4 2.5L		<b>BKR6E-11</b>	<b>2756</b>	FR6BHX-S	95159	BKR6EIX-11	3764	BKR6EGP	7092	BKR6E-11	2756	.044
1998	H4 2.2L		<b>BKR6E-11</b>	<b>2756</b>	FR6BHX-S	95159	BKR6EIX-11	3764	BKR6EGP	7092	BKR6E-11	2756	.044
	H4 2.5L		<b>PFR5B-11</b>	<b>2300</b>	FR5BHX	96457	BKR5EIX-11	5464	BKR5EGP	7090	BKR5E-11	6953	.044
1997	H4 1.8L		<b>BKR6E-11</b>	<b>2756</b>	FR6BHX-S	95159	BKR6EIX-11	3764	BKR6EGP	7092	BKR6E-11	2756	.044
	H4 2.2L		<b>BKR6E-11</b>	<b>2756</b>	FR6BHX-S	95159	BKR6EIX-11	3764	BKR6EGP	7092	BKR6E-11	2756	.044
1996-95	H4 1.8L		<b>BKR6E-11</b>	<b>2756</b>			BKR6EIX-11	3764	BKR6EGP	7092	BKR6E-11	2756	.044
	H4 2.2L		<b>BKR6E-11</b>	<b>2756</b>			BKR6EIX-11	3764	BKR6EGP	7092	BKR6E-11	2756	.044
1994-93	H4 1.8L		<b>BKR6E-11</b>	<b>2756</b>			BKR6EIX-11	3764	BKR6EGP	7092	BKR6E-11	2756	.044
<b>Justy</b>													
1995	L3 1.2L		<b>BPR6ES-11</b>	<b>7133</b>			BPR6EIX-11	3903	BPR6EGP	7084	BPR6EY-11	6261	.044
1994-91	L3 1.2L		<b>BUR6EA-11</b>	<b>4690</b>									.044
1990-87	L3 1.2L		<b>BPR6ES-11</b>	<b>7133</b>			BPR6EIX-11	3903	BPR6EGP	7084	BPR6EY-11	6261	.044
<b>Legacy</b>													
2017-13	H4 2.5L		<b>SILZKAR7B11</b>	<b>93482</b>	LKAR7AHX-S	92274	LKAR7BIX-11S	93501	LKAR7BGP-S	92649			.044

**Bold denotes NGK OE Manufacturer and/or OE Service Part**  
 NOT BOLD denotes OE Equivalent Part

Note: Due to different operating or engine conditions, alternate heat range plugs may be required.

229

**Le texte en gras désigne une pièce d'équipement originale du manufacturier NGK et/ou pièce d'équipement originale de service**  
 Le texte non en gras désigne une pièce d'équipement originale équivalente

Note: En raison de différences au niveau du fonctionnement ou des conditions du moteur, d'autres types de bougies avec variation de chaleur peuvent être nécessaires



Year	Cyl. L	Notes	Original Equipment		Ruthenium HX		Iridium IX		G-Power		V-Power		Gap
			Part	Stock	Part	Stock	Part	Stock	Part	Stock	Part	Stock	
<b>SUBARU (Cont'd)</b>													
Legacy (Cont'd)													
2017-13	H6 3.6L		<b>SILFR6C11</b>	<b>7505</b>	LFR6BHX	93420	LFR6AIX-11	6619	LFR6CGP	1483	LFR6C-11	7787	.044
2012-10	H4 2.5L	Naturally Aspirated	<b>SIFR6A11</b>	<b>127</b>	FR6BHX-S	95159	BKR6EIX-11	3764	BKR6EGP	7092			.044
		Turbo	<b>SILFR6B8</b>	<b>373</b>	LFR6BHX	93420	LFR6AIX	93893	LFR6CGP	1483			.032
2009-08	H4 2.5L	Naturally Aspirated	<b>FR5AP-11</b>	<b>5463</b>	FR5BHX	96457	BKR5EIX-11	5464	BKR5EGP	7090	BKR5E-11	6953	.044
		Turbo	<b>SILFR6A</b>	<b>7913</b>	LFR6BHX	93420	LFR6AIX	93893	LFR6CGP	1483			.030
	H6 3.0L		<b>ILFR6B</b>	<b>6481</b>	LFR6BHX	93420	LFR6AIX	93893	LFR6CGP	1483			.030
2007-05	H4 2.5L	Naturally Aspirated	<b>FR5AP-11</b>	<b>5463</b>	FR5BHX	96457	BKR5EIX-11	5464	BKR5EGP	7090	BKR5E-11	6953	.044
		Turbo	<b>SILFR6A</b>	<b>7913</b>	LFR6BHX	93420	LFR6AIX	93893	LFR6CGP	1483			.030
2004	H4 2.5L		<b>FR5AP-11</b>	<b>5463</b>	FR5BHX	96457	BKR5EIX-11	5464	BKR5EGP	7090	BKR5E	7938	.044
2003-00	H4 2.5L		<b>BKR6E-11</b>	<b>2756</b>	FR6BHX-S	95159	BKR6EIX-11	3764	BKR6EGP	7092	BKR6E-11	2756	.044
1999-97	H4 2.2L		<b>BKR6E-11</b>	<b>2756</b>	FR6BHX-S	95159	BKR6EIX-11	3764	BKR6EGP	7092	BKR6E-11	2756	.044
	H4 2.5L		<b>PFR5B-11</b>	<b>2300</b>	FR5BHX	96457	BKR5EIX-11	5464	BKR5EGP	7090	BKR5E-11	6953	.044
1996	H4 2.2L		<b>BKR6E-11</b>	<b>2756</b>			BKR6EIX-11	3764	BKR6EGP	7092	BKR6E-11	2756	.044
	H4 2.5L		<b>PFR5B-11</b>	<b>2300</b>			BKR5EIX-11	5464	BKR5EGP	7090	BKR5E-11	6953	.044
1995-90	H4 2.2L		<b>BKR6E-11</b>	<b>2756</b>			BKR6EIX-11	3764	BKR6EGP	7092	BKR6E-11	2756	.044
Loyale													
1994-90	H4 1.8L		<b>BPR6ES-11</b>	<b>7133</b>			BPR6EIX-11	3903	BPR6EGP	7084	BPR6EY-11	6261	.044
Outback													
2017-13	H4 2.5L		<b>SILZKAR7B11</b>	<b>93482</b>	LKAR7AHX-S	92274	LKAR7BIX-11S	93501	LKAR7BGP-S	92649			.044
	H6 3.6L		<b>SILFR6C11</b>	<b>7505</b>	LFR6BHX	93420	LFR6AIX-11	6619	LFR6CGP	1483	LFR6C-11	7787	.044
2012-10	H4 2.5L		<b>SIFR6A11</b>	<b>127</b>	FR6BHX-S	95159	BKR6EIX-11	3764	BKR6EGP	7092	BKR6E-11	2756	.044
			<b>SILFR6C11</b>	<b>7505</b>	LFR6BHX	93420	LFR6AIX-11	6619	LFR6CGP	1483	LFR6C-11	7787	.044
2009-05	H4 2.5L	Naturally Aspirated	<b>FR5AP-11</b>	<b>5463</b>	FR5BHX	96457	BKR5EIX-11	5464	BKR5EGP	7090	BKR5E-11	6953	.044
		Turbo	<b>SILFR6A</b>	<b>7913</b>	LFR6BHX	93420	LFR6AIX	93893	LFR6CGP	1483			.030
	H6 3.0L		<b>ILFR6B</b>	<b>6481</b>	LFR6BHX	93420	LFR6AIX	93893	LFR6CGP	1483			.030
2004	H4 2.5L		<b>FR5AP-11</b>	<b>5463</b>	FR5BHX	96457	BKR5EIX-11	5464	BKR5EGP	7090	BKR5E-11	6953	.044
	H6 3.0L		<b>PLFR6A-11</b>	<b>7654</b>	LFR6AHX-S	94122	LFR6AIX-11	6619	LFR6CGP	1483	LFR6A-11	3672	.044
2003-01	H4 2.5L		<b>BKR6E-11</b>	<b>2756</b>	FR6BHX-S	95159	BKR6EIX-11	3764	BKR6EGP	7092	BKR6E-11	2756	.044
	H6 3.0L		<b>PLFR6A-11</b>	<b>7654</b>	LFR6AHX-S	94122	LFR6AIX-11	6619	LFR6CGP	1483	LFR6A-11	3672	.044
2000	H4 2.5L		<b>BKR6E-11</b>	<b>2756</b>	FR6BHX-S	95159	BKR6EIX-11	3764	BKR6EGP	7092	BKR6E-11	2756	.044
RX													
1989-86	H4 1.8L		<b>BPR6ES-11</b>	<b>7133</b>			BPR6EIX-11	3903	BPR6EGP	7084	BPR6EY-11	6261	.044
Standard													
1987	H4 1.6L		<b>BPR6ES-11</b>	<b>7133</b>			BPR6EIX-11	3903	BPR6EGP	7084	BPR6EY-11	6261	.044
	H4 1.8L		<b>BPR6ES-11</b>	<b>7133</b>			BPR6EIX-11	3903	BPR6EGP	7084	BPR6EY-11	6261	.044
1986-85	H4 1.6L		<b>BPR6ES-11</b>	<b>7133</b>			BPR6EIX-11	3903	BPR6EGP	7084	BPR6EY-11	6261	.044
SVX													
1997	H6 3.3L		<b>PFR6B-11</b>	<b>4014</b>	FR6AHX-S	94279	BKR6EIX-11	3764	BKR6EGP	7092	BKR6E-11	2756	.044
1996-92	H6 3.3L		<b>PFR6B-11</b>	<b>4014</b>			BKR6EIX-11	3764	BKR6EGP	7092	BKR6E-11	2756	.044
Tribeca													
2014-10	H6 3.6L		<b>SILFR6C11</b>	<b>7505</b>	LFR6BHX	93420	LFR6AIX-11	6619	LFR6CGP	1483	LFR6C-11	7787	.044
2009-08	H6 3.6L		<b>SILFR6A</b>	<b>7913</b>	LFR6BHX	93420	LFR6AIX	93893	LFR6CGP	1483			.030
WRX													
2018-15	H4 2.0L	Turbo	<b>ILKAR8H6</b>	<b>96024</b>									.024
2014-13	H4 2.5L	Turbo	<b>SILFR6A</b>	<b>7913</b>	LFR6BHX	93420	LFR6AIX	93893	LFR6CGP	1483			.030
WRX STI													
2018-13	H4 2.5L	Turbo	<b>SILFR6A</b>	<b>7913</b>	LFR6BHX	93420	LFR6AIX	93893	LFR6CGP	1483			.030
XT													
1991-89	H4 1.8L		<b>BPR6ES-11</b>	<b>7133</b>			BPR6EIX-11	3903	BPR6EGP	7084	BPR6EY-11	6261	.044
	H6 2.7L		<b>BPR6ES-11</b>	<b>7133</b>			BPR6EIX-11	3903	BPR6EGP	7084	BPR6EY-11	6261	.044
1988	H4 1.8L		<b>BPR6ES-11</b>	<b>7133</b>			BPR6EIX-11	3903	BPR6EGP	7084	BPR6EY-11	6261	.044
	H6 2.7L		<b>BPR6ES-11</b>	<b>7133</b>			BPR6EIX-11	3903	BPR6EGP	7084	BPR6EY-11	6261	.044
1987-86	H4 1.8L		<b>BPR6ES-11</b>	<b>7133</b>			BPR6EIX-11	3903	BPR6EGP	7084	BPR6EY-11	6261	.044
1985	H4 1.8L	Naturally Aspirated	<b>BPR6ES-11</b>	<b>7133</b>			BPR6EIX-11	3903	BPR6EGP	7084	BPR6EY-11	6261	.044
		Turbo	<b>BPR6ES-11</b>	<b>7133</b>			BPR6EIX-11	3903	BPR6EGP	7084	BPR6EY-11	6261	.044





Year	Cyl. L	Notes	Original Equipment		Ruthenium HX		Iridium IX		G-Power		V-Power		Gap
			Part	Stock	Part	Stock	Part	Stock	Part	Stock	Part	Stock	
<b>SUBARU (Cont'd)</b>													
XV Crosstrek													
2015-14	H4 2.0L	ELECTRIC/GAS	<b>DILZKAR7B11</b>	<b>90935</b>	LKAR7AHX-S	92274							.044
		GAS	<b>SILZKAR7B11</b>	<b>93482</b>	LKAR7AHX-S	92274	LKAR7BIX-11S	93501	LKAR7BGP-S	92649			.044
2013	H4 2.0L		<b>SILZKAR7B11</b>	<b>93482</b>	LKAR7AHX-S	92274	LKAR7BIX-11S	93501	LKAR7BGP-S	92649			.044
<b>SUZUKI</b>													
Aerio													
2007-04	L4 2.3L		<b>IFR5J11</b>	<b>7418</b>	FR5AHX	95839	BKR5EIX-11	5464	BKR5EGP	7090	BKR5E-11	6953	.044
2003-02	L4 2.0L		<b>IFR5J11</b>	<b>7418</b>	FR5AHX	95839	BKR5EIX-11	5464	BKR5EGP	7090	BKR5E-11	6953	.044
Equator													
2012-09	L4 2.5L		<b>PLFR5A-11</b>	<b>6240</b>	LFR5AHX	96355	LFR5AIX-11	4469	LFR5AGP	5018	LFR5A-11	6376	.044
	V6 4.0L		<b>PLFR5A-11</b>	<b>6240</b>	LFR5AHX	96355	LFR5AIX-11	4469	LFR5AGP	5018	LFR5A-11	6376	.044
Esteem													
2002	L4 1.8L		<b>IFR6J11</b>	<b>7658</b>	FR6AHX-S	94279	BKR6EIX-11	3764	BKR6EGP	7092	BKR6E-11	2756	.044
2001	L4 1.6L		<b>BKR6E-11</b>	<b>2756</b>	FR6BHX-S	95159	BKR6EIX-11	3764	BKR6EGP	7092	BKR6E-11	2756	.044
	L4 1.8L		<b>IFR6J11</b>	<b>7658</b>	FR6AHX-S	94279	BKR6EIX-11	3764	BKR6EGP	7092	BKR6E-11	2756	.044
2000-99	L4 1.6L		<b>BKR6E</b>	<b>6962</b>	FR6BHX-S	95159	BKR6EIX	6418	BKR6EGP	7092	BKR6E	6962	.032
	L4 1.8L		<b>BKR6E-11</b>	<b>2756</b>	FR6AHX-S	94279	BKR6EIX-11	3764	BKR6EGP	7092	BKR6E-11	2756	.044
1998	L4 1.6L		<b>BKR6E</b>	<b>6962</b>	FR6BHX-S	95159	BKR6EIX	6418	BKR6EGP	7092	BKR6E	6962	.032
1997	L4 1.6L		<b>BKR6E</b>	<b>6962</b>	FR6AHX-S	94279	BKR6EIX	6418	BKR6EGP	7092	BKR6E	6962	.032
1996-95	L4 1.6L		<b>BKR6E</b>	<b>6962</b>			BKR6EIX	6418	BKR6EGP	7092	BKR6E	6962	.032
Forenza													
2008-04	L4 2.0L		BKR6EK	2288	FR6BHX-S	95159	BKR6EIX	6418	BKR6EGP	7092	BKR6E	6962	.032
Forsa													
1988-85	L3 1.0L		<b>BPR6ES</b>	<b>7131</b>			BPR6EIX	6637	BPR6EGP	7084	BPR6EY	6427	.032
Grand Vitara													
2012-11	L4 2.4L		<b>SILFR6A11</b>	<b>5468</b>	LFR6BHX	93420	LFR6AIX-11	6619	LFR6CGP	1483	LFR6C-11	7787	.044
2010-09	L4 2.4L		<b>SILFR6A11</b>	<b>5468</b>	LFR6BHX	93420	LFR6AIX-11	6619	LFR6CGP	1483	LFR6C-11	7787	.044
	V6 3.2L		PLTR6A-10G	3587	LTR6AHX	91276	LTR6IX-11	6509	LTR6GP	90198			.039
2008-06	V6 2.7L		<b>IFR6J11</b>	<b>7658</b>	FR6AHX-S	94279	BKR6EIX-11	3764	BKR6EGP	7092	BKR6E-11	2756	.044
2005-02	V6 2.5L		<b>IFR5J11</b>	<b>7418</b>	FR5AHX	95839	BKR5EIX-11	5464	BKR5EGP	7090	BKR5E-11	6953	.044
2001	V6 2.5L		<b>IFR5J11</b>	<b>7418</b>	FR5AHX	95839	BKR5EIX-11	5464	BKR5EGP	7090	BKR5E-11	6953	.044
	V6 2.7L		<b>IFR5J11</b>	<b>7418</b>	FR5AHX	95839	BKR5EIX-11	5464	BKR5EGP	7090	BKR5E-11	6953	.044
2000	V6 2.5L		<b>IFR5J11</b>	<b>7418</b>	FR5AHX	95839	BKR5EIX-11	5464	BKR5EGP	7090	BKR5E-11	6953	.044
1999	V6 2.5L		<b>BKR6E-11</b>	<b>2756</b>	FR6AHX-S	94279	BKR6EIX-11	3764	BKR6EGP	7092	BKR6E-11	2756	.044
Kizashi													
2013-10	L4 2.4L		<b>SILFR6A11</b>	<b>5468</b>	LFR6BHX	93420	LFR6AIX-11	6619	LFR6CGP	1483	LFR6C-11	7787	.044
Reno													
2008-05	L4 2.0L		BKR6EK	2288	FR6BHX-S	95159	BKR6EIX	6418	BKR6EGP	7092	BKR6E	6962	.032
SA310													
1985	L3 1.0L		<b>BPR6ES</b>	<b>7131</b>			BPR6EIX	6637	BPR6EGP	7084	BPR6EY	6427	.032
Samurai													
1995-85	L4 1.3L		<b>BPR5ES</b>	<b>7734</b>			BPR5EIX	6597	BPR5EGP	7082	BPR5EY	1233	.032
Sidekick													
1998	L4 1.6L		<b>BKR6E</b>	<b>6962</b>	FR6AHX-S	94279	BKR6EIX	6418	BKR6EGP	7092	BKR6E	6962	.032
	L4 1.8L		<b>BKR6E</b>	<b>6962</b>	FR6AHX-S	94279	BKR6EIX	6418	BKR6EGP	7092	BKR6E	6962	.032
1997	L4 1.6L	JA	<b>BKR6E</b>	<b>6962</b>	FR6AHX-S	94279	BKR6EIX	6418	BKR6EGP	7092	BKR6E	6962	.032
		JS	<b>BKR6E</b>	<b>6962</b>	FR6AHX-S	94279	BKR6EIX	6418	BKR6EGP	7092	BKR6E	6962	.032
		JX	<b>BKR6E</b>	<b>6962</b>	FR6AHX-S	94279	BKR6EIX	6418	BKR6EGP	7092	BKR6E	6962	.032
	L4 1.8L		<b>BKR6E</b>	<b>6962</b>	FR6AHX-S	94279	BKR6EIX	6418	BKR6EGP	7092	BKR6E	6962	.032
1996	L4 1.6L	JA	<b>BKR6E</b>	<b>6962</b>			BKR6EIX	6418	BKR6EGP	7092	BKR6E	6962	.032
		JS	<b>BKR6E</b>	<b>6962</b>			BKR6EIX	6418	BKR6EGP	7092	BKR6E	6962	.032
		JX	<b>BKR6E</b>	<b>6962</b>			BKR6EIX	6418	BKR6EGP	7092	BKR6E	6962	.032
	L4 1.8L		<b>BKR6E</b>	<b>6962</b>			BKR6EIX	6418	BKR6EGP	7092	BKR6E	6962	.032
1995	L4 1.6L		<b>BKR6E</b>	<b>6962</b>			BKR6EIX	6418	BKR6EGP	7092	BKR6E	6962	.032
1994-93	L4 1.6L	Eng Desg G16KC	<b>BPR5EY</b>	<b>1233</b>			BPR5EIX	6597	BPR5EGP	7082	BPR5EY	1233	.032
		Eng Desg G16KV	<b>BKR6E</b>	<b>6962</b>			BKR6EIX	6418	BKR6EGP	7092	BKR6E	6962	.032
1992	L4 1.6L	Eng Desg G16KC	<b>BPR5ES</b>	<b>7734</b>			BPR5EIX	6597	BPR5EGP	7082	BPR5EY	1233	.032
1991-90	L4 1.6L		<b>BPR5ES</b>	<b>7734</b>			BPR5EIX	6597	BPR5EGP	7082	BPR5EY	1233	.032

**Bold denotes NGK OE Manufacturer and/or OE Service Part**  
 NOT BOLD denotes OE Equivalent Part

**Le texte en gras désigne une pièce d'équipement originale du manufacturier NGK et/ou pièce d'équipement originale de service**  
 Le texte non en gras désigne une pièce d'équipement originale équivalente

Note: Due to different operating or engine conditions, alternate heat range plugs may be required.

Note: En raison de différences au niveau du fonctionnement ou des conditions du moteur, d'autres types de bougies avec variation de chaleur peuvent être nécessaires



Year	Cyl. L	Notes	Original Equipment		Ruthenium HX		Iridium IX		G-Power		V-Power		Gap
			Part	Stock	Part	Stock	Part	Stock	Part	Stock	Part	Stock	
<b>SUZUKI (Cont'd)</b>													
Sidekick (Cont'd)													
1989	L4 1.3L		<b>BPR5ES</b>	<b>7734</b>			BPR5EIX	6597	BPR5EGP	7082	BPR5EY	1233	.032
	L4 1.6L		<b>BPR5ES</b>	<b>7734</b>			BPR5EIX	6597	BPR5EGP	7082	BPR5EY	1233	.032
SJ410													
1985	L4 1.0L		<b>BPR5ES</b>	<b>7734</b>			BPR5EIX	6597	BPR5EGP	7082	BPR5EY	1233	.032
SJ413													
1985	L4 1.3L		<b>BPR5ES</b>	<b>7734</b>			BPR5EIX	6597	BPR5EGP	7082	BPR5EY	1233	.032
Swift													
2001-98	L4 1.3L		<b>BKR6E-11</b>	<b>2756</b>	FR6BHX-S	95159	BKR6EIX-11	3764	BKR6EGP	7092	BKR6E-11	2756	.044
1997	L4 1.3L		<b>BKR6E-11</b>	<b>2756</b>	FR6AHX-S	94279	BKR6EIX-11	3764	BKR6EGP	7092	BKR6E-11	2756	.044
1996-95	L4 1.3L		<b>BKR6E-11</b>	<b>2756</b>			BKR6EIX-11	3764	BKR6EGP	7092	BKR6E-11	2756	.044
1994	L3 1.0L		<b>BPR6ES-11</b>	<b>7133</b>			BPR6EIX-11	3903	BPR6EGP	7084	BPR6EY-11	6261	.044
	L4 1.3L		<b>BPR6ES-11</b>	<b>7133</b>			BPR6EIX-11	3903	BPR6EGP	7084	BPR6EY-11	6261	.044
1993-92	L3 1.0L		<b>BPR6ES-11</b>	<b>7133</b>			BPR6EIX-11	3903	BPR6EGP	7084	BPR6EY-11	6261	.044
	L4 1.3L		<b>BPR6ES-11</b>	<b>7133</b>			BPR6EIX-11	3903	BPR6EGP	7084	BPR6EY-11	6261	.044
	L4 1.6L		<b>BKR6E</b>	<b>6962</b>			BKR6EIX	6418	BKR6EGP	7092	BKR6E	6962	.032
1991-89	L4 1.3L		<b>BPR6ES-11</b>	<b>7133</b>			BPR6EIX-11	3903	BPR6EGP	7084	BPR6EY-11	6261	.044
Swift+													
2009	L4 1.6L		<b>ZFR6U-9</b>	<b>90318</b>	FR6AHX-S	94279	ZFR6FIX-11	6441	ZFR6FGP	7100	ZFR6U-9	90318	.036
2008-04	L4 1.6L		<b>BKR6E-11</b>	<b>2756</b>	FR6BHX-S	95159	BKR6EIX-11	3764	BKR6EGP	7092	BKR6E-11	2756	.044
SX4													
2013-10	L4 2.0L		<b>SILFR5A11</b>	<b>92373</b>	LFR5AHX	96355	LFR5AIX-11	4469	LFR5AGP	5018			.044
2009-07	L4 2.0L		<b>IFR5J11</b>	<b>7418</b>	FR5AHX	95839	BKR5EIX-11	5464	BKR5EGP	7090	BKR5E-11	6953	.044
SX4 Crossover													
2012	L4 2.0L		<b>SILFR5A11</b>	<b>92373</b>	LFR5AHX	96355	LFR5AIX-11	4469	LFR5AGP	5018			.044
Verona													
2006-05	L6 2.5L		<b>IFR6E11</b>	<b>6741</b>	FR6AHX-S	94279	BKR6EIX-11	3764	BKR6EGP	7092	BKR6E-11	2756	.044
2004	L6 2.5L		<b>BKUR6ETB</b>	<b>6992</b>	FR6BHX-S	95159	BKR6EIX	6418	BKR6EGP	7092	BKR6E	6962	.032
Vitara													
2004	V6 2.5L		<b>IFR5J11</b>	<b>7418</b>	FR5AHX	95839	BKR5EIX-11	5464	BKR5EGP	7090	BKR5E-11	6953	.044
2003	L4 2.0L		<b>IFR5J11</b>	<b>7418</b>	FR5AHX	95839	BKR5EIX-11	5464	BKR5EGP	7090	BKR5E-11	6953	.044
2002-01	L4 1.6L		<b>IFR6E11</b>	<b>6741</b>	FR6BHX-S	95159	BKR6EIX-11	3764	BKR6EGP	7092	BKR6E-11	2756	.044
	L4 2.0L		<b>IFR5J11</b>	<b>7418</b>	FR5AHX	95839	BKR5EIX-11	5464	BKR5EGP	7090	BKR5E-11	6953	.044
2000	L4 1.6L		<b>BKR6E-11</b>	<b>2756</b>	FR6BHX-S	95159	BKR6EIX-11	3764	BKR6EGP	7092	BKR6E-11	2756	.044
	L4 2.0L		<b>IFR5J11</b>	<b>7418</b>	FR5AHX	95839	BKR5EIX-11	5464	BKR5EGP	7090	BKR5E-11	6953	.044
1999	L4 1.6L		<b>BKR6E-11</b>	<b>2756</b>	FR6BHX-S	95159	BKR6EIX-11	3764	BKR6EGP	7092	BKR6E-11	2756	.044
	L4 2.0L		<b>BKR6E-11</b>	<b>2756</b>	FR6AHX-S	94279	BKR6EIX-11	3764	BKR6EGP	7092	BKR6E-11	2756	.044
X-90													
1998-97	L4 1.6L		<b>BKR6E</b>	<b>6962</b>	FR6AHX-S	94279	BKR6EIX	6418	BKR6EGP	7092	BKR6E	6962	.032
1996	L4 1.6L		<b>BKR6E</b>	<b>6962</b>			BKR6EIX	6418	BKR6EGP	7092	BKR6E	6962	.032
XL-7													
2009-07	V6 3.6L		PLTR6A-10G	3587	LTR6AHX	91276	LTR6IX-11	6509	LTR6GP	90198			.044
2006-04	V6 2.7L		<b>IFR6J11</b>	<b>7658</b>	FR6AHX-S	94279	BKR6EIX-11	3764	BKR6EGP	7092	BKR6E-11	2756	.044
2003-02	V6 2.7L		<b>IFR5J11</b>	<b>7418</b>	FR5AHX	95839	BKR5EIX-11	5464	BKR5EGP	7090	BKR5E-11	6953	.044
<b>TOYOTA</b>													
4Runner													
2017-15	V6 4.0L		<b>ILFR5T11</b>	<b>96779</b>	LFR5AHX	96355	LFR5AIX-11	4469	LFR5AGP	5018	LFR5A-11	6376	.044
2014	V6 4.0L	From 6/2013	<b>ILFR5T11</b>	<b>96779</b>	LFR5AHX	96355	LFR5AIX-11	4469	LFR5AGP	5018	LFR5A-11	6376	.044
2013	V6 4.0L	From 6/2013	<b>ILFR5T11</b>	<b>96779</b>	LFR5AHX	96355	LFR5AIX-11	4469	LFR5AGP	5018	LFR5A-11	6376	.044
		To 6/2013	<b>ILFR6T11</b>	<b>4904</b>	LFR6AHX-S	94122	LFR6AIX-11	6619	LFR6CGP	1483	LFR6C-11	7787	.044
2012-11	V6 4.0L		<b>ILFR6T11</b>	<b>4904</b>	LFR6AHX-S	94122	LFR6AIX-11	6619	LFR6CGP	1483	LFR6C-11	7787	.044
2010	L4 2.7L		<b>ILFR6T11</b>	<b>4904</b>	LFR6AHX-S	94122	LFR6AIX-11	6619	LFR6CGP	1483	LFR6C-11	7787	.044
	V6 4.0L		<b>ILFR6T11</b>	<b>4904</b>	LFR6AHX-S	94122	LFR6AIX-11	6619	LFR6CGP	1483	LFR6C-11	7787	.044
2009-05	V6 4.0L		<b>LFR6C-11</b>	<b>7787</b>	LFR6AHX-S	94122	LFR6AIX-11	6619	LFR6CGP	1483	LFR6C-11	7787	.044
	V8 4.7L		<b>IFR6T11</b>	<b>4589</b>	FR6AHX-S	94279	BKR6EIX-11	3764	BKR6EGP	7092	BKR6E-11	2756	.044
2004-03	V6 4.0L		<b>LFR6C-11</b>	<b>7787</b>	LFR6AHX-S	94122	LFR6AIX-11	6619	LFR6CGP	1483	LFR6C-11	7787	.044
	V8 4.7L		<b>BKR6EP-11</b>	<b>2978</b>	FR6AHX-S	94279	BKR6EIX-11	3764	BKR6EGP	7092	BKR6E-11	2756	.044
2002-01	V6 3.4L		<b>BKR5KCB-11</b>	<b>3967</b>	FR5BHX	96457	BKR5EIX-11	5464	BKR5EGP	7090	BKR5E-11	6953	.044



Year	Cyl. L	Notes	Original Equipment		Ruthenium HX		Iridium IX		G-Power		V-Power		Gap
			Part	Stock	Part	Stock	Part	Stock	Part	Stock	Part	Stock	
<b>TOYOTA (Cont'd)</b>													
<b>4Runner (Cont'd)</b>													
2000	L4 2.7L	Calif. Emissions	<b>BKR5EYA-11</b>	<b>2526</b>	FR5AHX	95839	BKR5EIX-11	5464	BKR5EGP	7090	BKR5EYA-11	2526	.044
		Federal Emissions	<b>BKR5EYA</b>	<b>2087</b>	FR5AHX	95839	BKR5EIX	6341	BKR5EGP	7090	BKR5EYA	2087	.032
	V6 3.4L		<b>BKR5EKB-11</b>	<b>3967</b>	FR5BHx	96457	BKR5EIX-11	5464	BKR5EGP	7090	BKR5E-11	6953	.044
1999-97	L4 2.7L		<b>BKR5EYA</b>	<b>2087</b>	FR5BHx	96457	BKR5EIX	6341	BKR5EGP	7090	BKR5EYA	2087	.032
	V6 3.4L		<b>BKR5EKB-11</b>	<b>3967</b>	FR5BHx	96457	BKR5EIX-11	5464	BKR5EGP	7090	BKR5E-11	6953	.044
1996	L4 2.7L		<b>BKR5EYA</b>	<b>2087</b>			BKR5EIX	6341	BKR5EGP	7090	BKR5EYA	2087	.032
	V6 3.4L		<b>BKR5EKB-11</b>	<b>3967</b>			BKR5EIX-11	5464	BKR5EGP	7090	BKR5E-11	6953	.044
1995-89	L4 2.4L		<b>BPR5EY</b>	<b>1233</b>			BPR5EIX	6597	BPR5EGP	7082	BPR5EY	1233	.032
	V6 3.0L		<b>BKR5EYA</b>	<b>2087</b>			BKR5EIX	6341	BKR5EGP	7090	BKR5EYA	2087	.032
1988	L4 2.4L	Naturally Aspirated	<b>BPR5EY</b>	<b>1233</b>			BPR5EIX	6597	BPR5EGP	7082	BPR5EY	1233	.032
		Turbo	<b>BPR5ES</b>	<b>7734</b>			BPR5EIX	6597	BPR5EGP	7082	BPR5EY	1233	.032
	V6 3.0L		<b>BCPR5EY</b>	<b>1266</b>			BCPR5EIX	5688	BCPR5EGP	7086	BCPR5EY	1266	.032
1987-85	L4 2.4L	Naturally Aspirated	<b>BPR5EY</b>	<b>1233</b>			BPR5EIX	6597	BPR5EGP	7082	BPR5EY	1233	.032
		Turbo	<b>BPR5ES</b>	<b>7734</b>			BPR5EIX	6597	BPR5EGP	7082	BPR5EY	1233	.032
<b>86</b>													
2018-17	H4 2.0L	Racing Plug - Track Use Only	R2558E-9	97537									.031
<b>Avalon</b>													
2017-05	V6 3.5L		DILFR6D11	6176	LF6AHX-S	94122	LF6AIX-11	6619	LF6CGP	1483			.044
2004-03	V6 3.0L		BKR6EP-11	2978	FR6AHX-S	94279	BKR6EIX-11	3764	BKR6EGP	7092	BKR6E-11	2756	.044
2002-00	V6 3.0L		<b>IFR6T11</b>	<b>4589</b>	FR6AHX-S	94279	BKR6EIX-11	3764	BKR6EGP	7092	BKR6E-11	2756	.044
1999-97	V6 3.0L		<b>BKR6EKP-11</b>	<b>3452</b>	FR6BHx-S	95159	BKR6EIX-11	3764	BKR6EGP	7092	BKR6EYA	7990	.044
1996	V6 3.0L		<b>BKR6EKP-11</b>	<b>3452</b>			BKR6EIX-11	3764	BKR6EGP	7092	BKR6EYA	7990	.044
1995	V6 3.0L		<b>BKR6EP-11</b>	<b>2978</b>			BKR6EIX-11	3764	BKR6EGP	7092	BKR6E-11	2756	.044
<b>Camry</b>													
2017-12	L4 2.5L	GAS	ILFR5T11	96779	LF6AHX	96355	LF6AIX-11	4469	LF6AGP	5018	LF6A-11	6376	.044
	V6 3.5L		DILFR6D11	6176	LF6AHX-S	94122	LF6AIX-11	6619	LF6CGP	1483			.044
2011-10	L4 2.4L		IFR6T11	4589	FR6AHX-S	94279	BKR6EIX-11	3764	BKR6EGP	7092	BKR6E-11	2756	.044
	L4 2.5L		ILFR5T11	96779	LF6AHX	96355	LF6AIX-11	4469	LF6AGP	5018	LF6A-11	6376	.044
	V6 3.5L		DILFR6D11	6176	LF6AHX-S	94122	LF6AIX-11	6619	LF6CGP	1483			.044
2009-07	L4 2.4L		IFR6T11	4589	FR6AHX-S	94279	BKR6EIX-11	3764	BKR6EGP	7092	BKR6E-11	2756	.044
	V6 3.5L		DILFR6D11	6176	LF6AHX-S	94122	LF6AIX-11	6619	LF6CGP	1483			.044
2006-05	L4 2.4L		IFR6T11	4589	FR6AHX-S	94279	BKR6EIX-11	3764	BKR6EGP	7092	BKR6E-11	2756	.044
	V6 3.0L		<b>IFR6T11</b>	<b>4589</b>	FR6AHX-S	94279	BKR6EIX-11	3764	BKR6EGP	7092	BKR6E-11	2756	.044
	V6 3.3L		IFR6T11	4589	FR6AHX-S	94279	BKR6EIX-11	3764	BKR6EGP	7092	BKR6E-11	2756	.044
2004	L4 2.4L		<b>IFR6T11</b>	<b>4589</b>	FR6AHX-S	94279	BKR6EIX-11	3764	BKR6EGP	7092	BKR6E-11	2756	.044
	V6 3.0L		<b>IFR6T11</b>	<b>4589</b>	FR6AHX-S	94279	BKR6EIX-11	3764	BKR6EGP	7092	BKR6E-11	2756	.044
	V6 3.3L		<b>IFR6T11</b>	<b>4589</b>	FR6AHX-S	94279	BKR6EIX-11	3764	BKR6EGP	7092	BKR6E-11	2756	.044
2003-02	L4 2.4L		<b>IFR6T11</b>	<b>4589</b>	FR6AHX-S	94279	BKR6EIX-11	3764	BKR6EGP	7092	BKR6E-11	2756	.044
	V6 3.0L		<b>IFR6T11</b>	<b>4589</b>	FR6AHX-S	94279	BKR6EIX-11	3764	BKR6EGP	7092	BKR6E-11	2756	.044
2001-97	L4 2.2L		<b>BKR6EKP-11</b>	<b>3452</b>	FR6BHx-S	95159	BKR6EIX-11	3764	BKR6EGP	7092	BKR6EYA	7990	.044
	V6 3.0L		<b>BKR6EKP-11</b>	<b>3452</b>	FR6BHx-S	95159	BKR6EIX-11	3764	BKR6EGP	7092	BKR6EYA	7990	.044
1996	L4 2.2L		<b>BKR6EP-11</b>	<b>2978</b>			BKR6EIX-11	3764	BKR6EGP	7092	BKR6E-11	2756	.044
	V6 3.0L		<b>BKR6EKP-11</b>	<b>3452</b>			BKR6EIX-11	3764	BKR6EGP	7092	BKR6EYA	7990	.044
1995-94	L4 2.2L		<b>BKR6EP-11</b>	<b>2978</b>			BKR6EIX-11	3764	BKR6EGP	7092	BKR6E-11	2756	.044
	V6 3.0L		<b>BKR6EP-11</b>	<b>2978</b>			BKR6EIX-11	3764	BKR6EGP	7092	BKR6E-11	2756	.044
1993-92	L4 2.2L		<b>BKR6EP-11</b>	<b>2978</b>			BKR6EIX-11	3764	BKR6EGP	7092	BKR6E-11	2756	.044
	V6 3.0L		<b>BCPR6EP-11</b>	<b>3350</b>			BCPR6EIX-11	4919	BCPR6EGP	7088	BCPR6E-11	5632	.044
1991-88	L4 2.0L		BCPR5EY-11	2441			BCPR5EIX-11	3306	BCPR5EGP	7086	BCPR5EY-11	2441	.044
	V6 2.5L		<b>BCPR6EP-11</b>	<b>3350</b>			BCPR6EIX-11	4919	BCPR6EGP	7088	BCPR6E-11	5632	.044
1987	L4 2.0L		BCPR5EY-11	2441			BCPR5EIX-11	3306	BCPR5EGP	7086	BCPR5EY-11	2441	.044
1986	L4 1.8L	DIESEL	Y-146R	7492									
	L4 2.0L	DIESEL	Y-703R	3782									
		GAS	BPR5ES-11	7634			BPR5EIX-11	2115	BPR5EGP	7082	BPR5EY-11	6937	.044
1985	L4 1.8L	DIESEL	Y-146R	7492									
	L4 2.0L		BPR5ES-11	7634			BPR5EIX-11	2115	BPR5EGP	7082	BPR5EY-11	6937	.044

**Bold denotes NGK OE Manufacturer and/or OE Service Part**  
 NOT BOLD denotes OE Equivalent Part

Note: Due to different operating or engine conditions, alternate heat range plugs may be required.

**Le texte en gras désigne une pièce d'équipement originale du manufacturier NGK et/ou pièce d'équipement originale de service**  
 Le texte non en gras désigne une pièce d'équipement originale équivalente

Note: En raison de différences au niveau du fonctionnement ou des conditions du moteur, d'autres types de bougies avec variation de chaleur peuvent être nécessaires



Year	Cyl. L	Notes	Original Equipment		Ruthenium HX		Iridium IX		G-Power		V-Power		Gap
			Part	Stock	Part	Stock	Part	Stock	Part	Stock	Part	Stock	
<b>TOYOTA (Cont'd)</b>													
<b>Celica</b>													
2005	L4 1.8L	Eng Desg 1ZZFE	IFR5T11	4996	FR5AHX	95839	BKR5EIX-11	5464	BKR5EGP	7090	BKR5EYA-11	2526	.044
		Eng Desg 2ZZGE	BKR6EP-11	2978	FR6AHX-S	94279	BKR6EIX-11	3764	BKR6EGP	7092	BKR6E-11	2756	.044
2004	L4 1.8L	Eng Desg 1ZZFE	BKR5EP-11	3440	FR5AHX	95839	BKR5EIX-11	5464	BKR5EGP	7090	BKR5EYA-11	2526	.044
		Eng Desg 2ZZGE	BKR6EP-11	2978	FR6AHX-S	94279	BKR6EIX-11	3764	BKR6EGP	7092	BKR6E-11	2756	.044
2003-00	L4 1.8L	Eng Desg 1ZZFE	<b>IFR5T11</b>	<b>4996</b>	FR5AHX	95839	BKR5EIX-11	5464	BKR5EGP	7090	BKR5E-11	6953	.044
		Eng Desg 2ZZGE	<b>IFR6T11</b>	<b>4589</b>	FR6AHX-S	94279	BKR6EIX-11	3764	BKR6EGP	7092	BKR6E-11	2756	.044
1999-98	L4 2.2L		<b>BKR6EP-11</b>	<b>2978</b>	FR6AHX-S	94279	BKR6EIX-11	3764	BKR6EGP	7092	BKR6E-11	2756	.044
1997	L4 1.8L		BKR5EYA	2087	FR5AHX	95839	BKR5EIX	6341	BKR5EGP	7090	BKR5EYA	2087	.032
	L4 2.2L		<b>BKR6EP-11</b>	<b>2978</b>	FR6AHX-S	94279	BKR6EIX-11	3764	BKR6EGP	7092	BKR6E-11	2756	.044
1996-94	L4 1.8L		BKR5EYA	2087			BKR5EIX	6341	BKR5EGP	7090	BKR5EYA	2087	.032
	L4 2.2L		<b>BKR6EP-11</b>	<b>2978</b>			BKR6EIX-11	3764	BKR6EGP	7092	BKR6E-11	2756	.044
1993-91	L4 1.6L		BCPR5EY	1266			BCPR5EIX	5688	BCPR5EGP	7086	BCPR5EY	1266	.032
	L4 2.0L		<b>BKR6EP-8</b>	<b>2215</b>			BKR6EIX	6418	BKR6EGP	7092	BKR6E	6962	.032
	L4 2.2L		<b>BKR6EP-11</b>	<b>2978</b>			BKR6EIX-11	3764	BKR6EGP	7092	BKR6E-11	2756	.044
1990	L4 1.6L		BCPR5EY	1266			BCPR5EIX	5688	BCPR5EGP	7086	BCPR5EY	1266	.032
	L4 2.0L		<b>BKR6EP-8</b>	<b>2215</b>			BKR6EIX	6418	BKR6EGP	7092	BKR6E	6962	.032
	L4 2.2L		<b>BKR5EYA-11</b>	<b>2526</b>			BKR5EIX-11	5464	BKR5EGP	7090	BKR5EYA-11	2526	.044
1989-88	L4 2.0L	Eng Desg 3SFE	BCPR5EY-11	2441			BCPR5EIX-11	3306	BCPR5EGP	7086	BCPR5EY-11	2441	.044
		Eng Desg 3SGELC	<b>BCPR5EP-11</b>	<b>2097</b>			BCPR5EIX-11	3306	BCPR5EGP	7086	BCPR5EY-11	2441	.044
		Eng Desg 3SGTE	BCPR5EY	1266			BCPR5EIX	5688	BCPR5EGP	7086	BCPR5EY	1266	.032
1987	L4 2.0L	Eng Desg 3SFE	BCPR5EY-11	2441			BCPR5EIX-11	3306	BCPR5EGP	7086	BCPR5EY-11	2441	.044
		Eng Desg 3SGELC	<b>BCPR5EP-11</b>	<b>2097</b>			BCPR5EIX-11	3306	BCPR5EGP	7086	BCPR5EY-11	2441	.044
1986	L4 2.0L	Eng Desg 2SELC	BPR5ES-11	7634			BPR5EIX-11	2115	BPR5EGP	7082	BPR5EY-11	6937	.044
		Eng Desg 3SGELC	<b>BCPR5EP-11</b>	<b>2097</b>			BCPR5EIX-11	3306	BCPR5EGP	7086	BCPR5EY-11	2441	.044
	L6 2.8L		<b>BPR5EP-11</b>	<b>3971</b>			BPR5EIX-11	2115	BPR5EGP	7082			.044
1985	L4 2.4L		<b>BPR5ES</b>	<b>7734</b>			BPR5EIX	6597	BPR5EGP	7082	BPR5EY	1233	.032
	L6 2.8L		<b>BPR5EP-11</b>	<b>3971</b>			BPR5EIX-11	2115	BPR5EGP	7082	BPR5EY-11	6937	.044
<b>Corolla</b>													
2015	L4 1.8L	To 3/2015	ILKAR7B11	4912	LKAR7AHX-S	92274	LKAR7BIX-11S	93501	LKAR7AGP-D	93220			.044
2014-13	L4 1.8L		ILKAR7B11	4912	LKAR7AHX-S	92274	LKAR7BIX-11S	93501	LKAR7AGP-D	93220			.044
2012	L4 1.8L		ILKAR7B11	4912	LKAR7AHX-S	92274	LKAR7BIX-11S	93501	LKAR7AGP-D	93220			.044
	L4 2.4L	From 6/2012	IFR5T11	4996	FR5AHX	95839	BKR5EIX-11	5464	BKR5EGP	7090	BKR5E-11	6953	.044
		To 6/2012	IFR6T11	4589	FR6AHX-S	94279	BKR6EIX-11	3764	BKR6EGP	7092	BKR6E-11	2756	.044
2011-09	L4 1.8L		ILKAR7B11	4912	LKAR7AHX-S	92274	LKAR7BIX-11S	93501	LKAR7AGP-D	93220			.044
	L4 2.4L		IFR6T11	4589	FR6AHX-S	94279	BKR6EIX-11	3764	BKR6EGP	7092	BKR6E-11	2756	.044
2008-07	L4 1.8L		IFR5T11	4996	FR5AHX	95839	BKR5EIX-11	5464	BKR5EGP	7090	BKR5E-11	6953	.044
2006-05	L4 1.8L	Eng Desg 1ZZFE	IFR5T11	4996	FR5AHX	95839	BKR5EIX-11	5464	BKR5EGP	7090	BKR5E-11	6953	.044
		Eng Desg 2ZZGE	BKR6EP-11	2978	FR6AHX-S	94279	BKR6EIX-11	3764	BKR6EGP	7092	BKR6E-11	2756	.044
2004-00	L4 1.8L		<b>IFR5T11</b>	<b>4996</b>	FR5AHX	95839	BKR5EIX-11	5464	BKR5EGP	7090	BKR5E-11	6953	.044
1999-98	L4 1.8L		<b>BKR5EKB-11</b>	<b>3967</b>	FR5BHX	96457	BKR5EIX-11	5464	BKR5EGP	7090	BKR5E-11	6953	.044
1997	L4 1.6L		<b>BKR5EYA</b>	<b>2087</b>	FR5AHX	95839	BKR5EIX	6341	BKR5EGP	7090	BKR5EYA	2087	.032
	L4 1.8L		BKR5EYA	2087	FR5AHX	95839	BKR5EIX	6341	BKR5EGP	7090	BKR5EYA	2087	.032
1996-93	L4 1.6L		<b>BKR5EYA</b>	<b>2087</b>			BKR5EIX	6341	BKR5EGP	7090	BKR5EYA	2087	.032
	L4 1.8L		BKR5EYA	2087			BKR5EIX	6341	BKR5EGP	7090	BKR5EYA	2087	.032
1992-90	L4 1.6L	Eng Desg 4AFE	BCPR5EY	1266			BCPR5EIX	5688	BCPR5EGP	7086	BCPR5EY	1266	.032
		Eng Desg 4AGE	BKR6EP-8	2215			BKR6EIX	6418	BKR6EGP	7092	BKR6E	6962	.032
1989	L4 1.6L	Eng Desg 4AF	BCPR5EY-11	2441			BCPR5EIX-11	3306	BCPR5EGP	7086	BCPR5EY-11	2441	.044
		Eng Desg 4AFE	BCPR5EY	1266			BCPR5EIX	5688	BCPR5EGP	7086	BCPR5EY	1266	.032
		Eng Desg 4AGE	BCPR5EP-11	2097			BCPR5EIX-11	3306	BCPR5EGP	7086	BCPR5EY-11	2441	.044
1988	L4 1.6L	Eng Desg 4AF	BCPR5EY-11	2441			BCPR5EIX-11	3306	BCPR5EGP	7086	BCPR5EY-11	2441	.044
		Eng Desg 4AFE	BCPR5EY	1266			BCPR5EIX	5688	BCPR5EGP	7086	BCPR5EY	1266	.032
		Eng Desg 4AGE	BCPR5EP-8	2950			BCPR5EIX	5688	BCPR5EGP	7086	BCPR5EY	1266	.032
		Eng Desg 4AGELC	<b>BCPR5EP-11</b>	<b>2097</b>			BCPR5EIX-11	3306	BCPR5EGP	7086	BCPR5EY-11	2441	.044
		Eng Desg 4ALC	BPR5EY-11	6937			BPR5EIX-11	2115	BPR5EGP	7082	BPR5EY-11	6937	.044
1987-86	L4 1.6L	CARB	<b>BPR5EY-11</b>	<b>6937</b>			BPR5EIX-11	2115	BPR5EGP	7082	BPR5EY-11	6937	.044
		FI	<b>BCPR5EP-11</b>	<b>2097</b>			BCPR5EIX-11	3306	BCPR5EGP	7086	BCPR5EY-11	2441	.044
1985	L4 1.6L	CARB	<b>BPR5EY-11</b>	<b>6937</b>			BPR5EIX-11	2115	BPR5EGP	7082	BPR5EY-11	6937	.044





Year	Cyl. L	Notes	Original Equipment		Ruthenium HX		Iridium IX		G-Power		V-Power		Gap
			Part	Stock	Part	Stock	Part	Stock	Part	Stock	Part	Stock	
<b>TOYOTA (Cont'd)</b>													
<b>Corolla (Cont'd)</b>													
1985		FI	<b>BCPR5EP-11</b>	<b>2097</b>			BCPR5EIX-11	3306	BCPR5EGP	7086	BCPR5EY-11	2441	.044
	L4 1.8L	DIESEL	Y-146R	7492									
<b>Cressida</b>													
1992-89	L6 3.0L		BCPR5EP-11	2097			BCPR5EIX-11	3306	BCPR5EGP	7086	BCPR5EY-11	2441	.044
1988-85	L6 2.8L		<b>BPR5EP-11</b>	<b>3971</b>			BPR5EIX-11	2115	BPR5EGP	7082	BPR5EY-11	6937	.044
<b>Echo</b>													
2005-01	L4 1.5L		BKR5EYA	2087	FR5AHX	95839	BKR5EIX	6341	BKR5EGP	7090	BKR5EYA	2087	.032
2000	L4 1.5L		IFR5T11	4996	FR5AHX	95839	BKR5EIX-11	5464	BKR5EGP	7090	BKR5E-11	6953	.044
<b>FJ Cruiser</b>													
2014	V6 4.0L	From 6/2013	ILFR5T11	96779	LFR5AHX	96355	LFR5AIX-11	4469	LFR5AGP	5018	LFR5A-11	6376	.044
2013	V6 4.0L	From 6/2013	ILFR5T11	96779	LFR5AHX	96355	LFR5AIX-11	4469	LFR5AGP	5018	LFR5A-11	6376	.044
		To 6/2013	ILFR6T11	4904	LFR6AHX-S	94122	LFR6AIX-11	6619	LFR6CGP	1483	LFR6C-11	7787	.044
2012-10	V6 4.0L		ILFR6T11	4904	LFR6AHX-S	94122	LFR6AIX-11	6619	LFR6CGP	1483	LFR6C-11	7787	.044
2009-07	V6 4.0L		<b>LFR6C-11</b>	<b>7787</b>	LFR6AHX-S	94122	LFR6AIX-11	6619	LFR6CGP	1483	LFR6C-11	7787	.044
<b>Highlander</b>													
2017	L4 2.7L		ILFR5T11	96779	LFR5AHX	96355	LFR5AIX-11	4469	LFR5AGP	5018	LFR5A-11	6376	.044
2016-11	L4 2.7L		ILFR5T11	96779	LFR5AHX	96355	LFR5AIX-11	4469	LFR5AGP	5018	LFR5A-11	6376	.044
	V6 3.5L		DILFR6D11	6176	LFR6AHX-S	94122	LFR6AIX-11	6619	LFR6CGP	1483			.044
2010-09	L4 2.7L		ILFR5T11	96779	LFR5AHX	96355	LFR5AIX-11	4469	LFR5AGP	5018	LFR5A-11	6376	.044
	V6 3.3L		IFR6T11	4589	FR6AHX-S	94279	BKR6EIX-11	3764	BKR6EGP	7092	BKR6E-11	2756	.044
	V6 3.5L		DILFR6D11	6176	LFR6AHX-S	94122	LFR6AIX-11	6619	LFR6CGP	1483			.044
2008	V6 3.3L		IFR6T11	4589	FR6AHX-S	94279	BKR6EIX-11	3764	BKR6EGP	7092	BKR6E-11	2756	.044
	V6 3.5L		DILFR6D11	6176	LFR6AHX-S	94122	LFR6AIX-11	6619	LFR6CGP	1483			.044
2007-04	L4 2.4L		IFR6T11	4589	FR6AHX-S	94279	BKR6EIX-11	3764	BKR6EGP	7092	BKR6E-11	2756	.044
	V6 3.3L		IFR6T11	4589	FR6AHX-S	94279	BKR6EIX-11	3764	BKR6EGP	7092	BKR6E-11	2756	.044
2003-01	L4 2.4L		IFR6T11	4589	FR6AHX-S	94279	BKR6EIX-11	3764	BKR6EGP	7092	BKR6E-11	2756	.044
	V6 3.0L		<b>IFR6T11</b>	<b>4589</b>	FR6AHX-S	94279	BKR6EIX-11	3764	BKR6EGP	7092	BKR6E-11	2756	.044
<b>Land Cruiser</b>													
2017-13	V8 5.7L		ILFR6T11	4904	LFR6AHX-S	94122	LFR6AIX-11	6619	LFR6CGP	1483	LFR6C-11	7787	.044
2011-08	V8 5.7L		ILFR6T11	4904	LFR6AHX-S	94122	LFR6AIX-11	6619	LFR6CGP	1483	LFR6C-11	7787	.044
2007-05	V8 4.7L		IFR6T11	4589	FR6AHX-S	94279	BKR6EIX-11	3764	BKR6EGP	7092	BKR6E-11	2756	.044
2004-98	V8 4.7L		<b>IFR6T11</b>	<b>4589</b>	FR6AHX-S	94279	BKR6EIX-11	3764	BKR6EGP	7092	BKR6E-11	2756	.044
1997	L6 4.5L		<b>BKR5EYA</b>	<b>2087</b>	FR5AHX	95839	BKR5EIX	6341	BKR5EGP	7090	BKR5EYA	2087	.032
1996-93	L6 4.5L		<b>BKR5EYA</b>	<b>2087</b>			BKR5EIX	6341	BKR5EGP	7090	BKR5EYA	2087	.032
1992-90	L6 4.0L		<b>BPR5ES-11</b>	<b>7634</b>			BPR5EIX-11	2115	BPR5EGP	7082	BPR5EY-11	6937	.044
1989-88	L6 4.0L		<b>BPR5EY</b>	<b>1233</b>			BPR5EIX	6597	BPR5EGP	7082	BPR5EY	1233	.032
1987	L4 2.4L	DIESEL	Y-118R	2187									
	L4 3.4L	DIESEL	Y-147T	7493									
	L6 4.2L		BPR5ES	7734			BPR5EIX	6597	BPR5EGP	7082	BPR5EY	1233	.032
1986	L4 3.4L	DIESEL	Y-147T	7493									
	L6 4.2L	DIESEL	<b>Y-197R</b>	<b>2188</b>									
		GAS	BPR5ES	7734			BPR5EIX	6597	BPR5EGP	7082	BPR5EY	1233	.032
1985	L4 3.4L	DIESEL	Y-147T	7493									
	L6 4.2L	GAS	BPR5ES	7734			BPR5EIX	6597	BPR5EGP	7082	BPR5EY	1233	.032
<b>Matrix</b>													
2014	L4 1.8L		ILKAR7B11	4912	LKAR7AHX-S	92274	LKAR7BIX-11S	93501	LKAR7AGP-D	93220			.044
2013	L4 1.8L		ILKAR7B11	4912	LKAR7AHX-S	92274	LKAR7BIX-11S	93501	LKAR7AGP-D	93220			.044
	L4 2.4L		IFR5T11	4996	FR5AHX	95839	BKR5EIX-11	5464	BKR5EGP	7090	BKR5E-11	6953	.044
2012	L4 1.8L		ILKAR7B11	4912	LKAR7AHX-S	92274	LKAR7BIX-11S	93501	LKAR7AGP-D	93220			.044
	L4 2.4L	From 6/2012	IFR5T11	4996	FR5AHX	95839	BKR5EIX-11	5464	BKR5EGP	7090	BKR5E-11	6953	.044
		To 6/2012	IFR6T11	4589	FR6AHX-S	94279	BKR6EIX-11	3764	BKR6EGP	7092	BKR6E-11	2756	.044
2011-09	L4 1.8L		ILKAR7B11	4912	LKAR7AHX-S	92274	LKAR7BIX-11S	93501	LKAR7AGP-D	93220			.044
	L4 2.4L		IFR6T11	4589	FR6AHX-S	94279	BKR6EIX-11	3764	BKR6EGP	7092	BKR6E-11	2756	.044
2008-07	L4 1.8L		IFR5T11	4996	FR5AHX	95839	BKR5EIX-11	5464	BKR5EGP	7090	BKR5E-11	6953	.044
2006-05	L4 1.8L	Eng Desg 1ZZFE	IFR5T11	4996	FR5AHX	95839	BKR5EIX-11	5464	BKR5EGP	7090	BKR5E-11	6953	.044
		Eng Desg 2ZZGE	<b>IFR6T11</b>	<b>4589</b>	FR6AHX-S	94279	BKR6EIX-11	3764	BKR6EGP	7092	BKR6E-11	2756	.044
2004	L4 1.8L	Eng Desg 1ZZFE	IFR5T11	4996	FR5AHX	95839	BKR5EIX-11	5464	BKR5EGP	7090	BKR5EYA-11	2526	.044

**Bold denotes NGK OE Manufacturer and/or OE Service Part**  
NOT BOLD denotes OE Equivalent Part

Note: Due to different operating or engine conditions, alternate heat range plugs may be required.

**Le texte en gras désigne une pièce d'équipement originale du manufacturier NGK et/ou pièce d'équipement originale de service**  
Le texte non en gras désigne une pièce d'équipement originale équivalente

Note: En raison de différences au niveau du fonctionnement ou des conditions du moteur, d'autres types de bougies avec variation de chaleur peuvent être nécessaires





Year	Cyl. L	Notes	Original Equipment		Ruthenium HX		Iridium IX		G-Power		V-Power		Gap
			Part	Stock	Part	Stock	Part	Stock	Part	Stock	Part	Stock	
<b>TOYOTA (Cont'd)</b>													
<b>Matrix (Cont'd)</b>													
2004		Eng Desg 2ZZGE	BKR6EP-11	2978	FR6AHX-S	94279	BKR6EIX-11	3764	BKR6EGP	7092	BKR6E-11	2756	.044
2003	L4 1.8L	Eng Desg 1ZZFE	IFR5T11	4996	FR5AHX	95839	BKR5EIX-11	5464	BKR5EGP	7090	BKR5E-11	6953	.044
		Eng Desg 2ZZGE	<b>IFR6T11</b>	<b>4589</b>	FR6AHX-S	94279	BKR6EIX-11	3764	BKR6EGP	7092	BKR6E-11	2756	.044
<b>MR2</b>													
1995-92	L4 2.0L		<b>BKR6EP-8</b>	<b>2215</b>			BKR6EIX	6418	BKR6EGP	7092	BKR6E	6962	.032
	L4 2.2L		<b>BKR6EP-11</b>	<b>2978</b>			BKR6EIX-11	3764	BKR6EGP	7092	BKR6E-11	2756	.044
1991	L4 2.0L		<b>BKR6EP-8</b>	<b>2215</b>			BKR6EIX	6418	BKR6EGP	7092	BKR6E	6962	.032
	L4 2.2L		<b>BKR5EYA-11</b>	<b>2526</b>			BKR5EIX-11	5464	BKR5EGP	7090	BKR5EYA-11	2526	.044
1989-88	L4 1.6L	Naturally Aspirated	<b>BCPR5EP-11</b>	<b>2097</b>			BCPR5EIX-11	3306	BCPR5EGP	7086	BCPR5EY-11	2441	.044
		Supercharged	<b>BCPR6EP-11</b>	<b>3350</b>			BCPR6EIX-11	4919	BCPR6EGP	7088	BCPR6E-11	5632	.044
1987-85	L4 1.6L		<b>BCPR5EP-11</b>	<b>2097</b>			BCPR5EIX-11	3306	BCPR5EGP	7086	BCPR5EY-11	2441	.044
<b>MR2 Spyder</b>													
2005-03	L4 1.8L		IFR5T11	4996	FR5AHX	95839	BKR5EIX-11	5464	BKR5EGP	7090	BKR5E-11	6953	.044
2002-00	L4 1.8L		<b>IFR5T11</b>	<b>4996</b>	FR5AHX	95839	BKR5EIX-11	5464	BKR5EGP	7090	BKR5E-11	6953	.044
<b>Paseo</b>													
1999-97	L4 1.5L		<b>BKR5EKB-11</b>	<b>3967</b>	FR5BHX	96457	BKR5EIX-11	5464	BKR5EGP	7090	BKR5E-11	6953	.044
1996	L4 1.5L		<b>BKR5EKB-11</b>	<b>3967</b>			BKR5EIX-11	5464	BKR5EGP	7090	BKR5E-11	6953	.044
1995	L4 1.5L	California Emissions	<b>BKR5EKB-11</b>	<b>3967</b>			BKR5EIX-11	5464	BKR5EGP	7090	BKR5E-11	6953	.044
		Federal Emissions	<b>BKR5EYA-11</b>	<b>2526</b>			BKR5EIX-11	5464	BKR5EGP	7090	BKR5EYA-11	2526	.044
1994-92	L4 1.5L		<b>BKR5EYA-11</b>	<b>2526</b>			BKR5EIX-11	5464	BKR5EGP	7090	BKR5EYA-11	2526	.044
<b>Pickup</b>													
1995-91	L4 2.4L		<b>BPR5EY</b>	<b>1233</b>			BPR5EIX	6597	BPR5EGP	7082	BPR5EY	1233	.032
	V6 3.0L		<b>BKR5EYA</b>	<b>2087</b>			BKR5EIX	6341	BKR5EGP	7090	BKR5EYA	2087	.032
1990-89	L4 2.4L	Eng Desg 22R	<b>BPR5ES</b>	<b>7734</b>			BPR5EIX	6597	BPR5EGP	7082	BPR5EY	1233	.032
		Eng Desg 22RE	<b>BPR5EY</b>	<b>1233</b>			BPR5EIX	6597	BPR5EGP	7082	BPR5EY	1233	.032
	V6 3.0L		<b>BKR5EYA</b>	<b>2087</b>			BKR5EIX	6341	BKR5EGP	7090	BKR5EYA	2087	.032
1988	L4 2.4L	Eng Desg 22R	<b>BPR5ES</b>	<b>7734</b>			BPR5EIX	6597	BPR5EGP	7082	BPR5EY	1233	.032
		Eng Desg 22REC	<b>BPR5EY</b>	<b>1233</b>			BPR5EIX	6597	BPR5EGP	7082	BPR5EY	1233	.032
		Eng Desg 22RTEC	<b>BPR5ES</b>	<b>7734</b>			BPR5EIX	6597	BPR5EGP	7082	BPR5EY	1233	.032
	V6 3.0L		<b>BKR5EYA</b>	<b>2087</b>			BKR5EIX	6341	BKR5EGP	7090	BKR5EYA	2087	.032
1987-85	L4 2.4L	CARB, Naturally Aspirated	<b>BPR5ES</b>	<b>7734</b>			BPR5EIX	6597	BPR5EGP	7082	BPR5EY	1233	.032
		DIESEL, Eng Desg 2L	Y-118R	2187									
		DIESEL, Eng Desg 2LT	Y-146R	7492									
		GAS, Eng Desg 22R	<b>BPR5ES</b>	<b>7734</b>			BPR5EIX	6597	BPR5EGP	7082	BPR5EY	1233	.032
		GAS, Eng Desg 22REC	<b>BPR5EY</b>	<b>1233</b>			BPR5EIX	6597	BPR5EGP	7082	BPR5EY	1233	.032
	GAS, Eng Desg 22RTEC	<b>BPR5ES</b>	<b>7734</b>			BPR5EIX	6597	BPR5EGP	7082	BPR5EY	1233	.032	
<b>Previa</b>													
1997	L4 2.4L		<b>BKR6EP-11</b>	<b>2978</b>	FR6BHX-S	95159	BKR6EIX-11	3764	BKR6EGP	7092	BKR6E-11	2756	.044
1996	L4 2.4L		<b>BKR6EP-11</b>	<b>2978</b>			BKR6EIX-11	3764	BKR6EGP	7092	BKR6E-11	2756	.044
1995	L4 2.4L	Naturally Aspirated	<b>BKR5EP-11</b>	<b>3440</b>			BKR5EIX-11	5464	BKR5EGP	7090	BKR5EYA-11	2526	.044
		Supercharged	<b>BKR6EP-11</b>	<b>2978</b>			BKR6EIX-11	3764	BKR6EGP	7092	BKR6E-11	2756	.044
1994-91	L4 2.4L		<b>BKR5EP-11</b>	<b>3440</b>			BKR5EIX-11	5464	BKR5EGP	7090	BKR5EYA-11	2526	.044
<b>Prius</b>													
2015	L4 1.8L	To 3/2015	ILKAR7B11	4912	LKAR7AHX-S	92274	LKAR7BIX-11S	93501	LKAR7AGP-D	93220			.044
2014-10	L4 1.8L		ILKAR7B11	4912	LKAR7AHX-S	92274	LKAR7BIX-11S	93501	LKAR7AGP-D	93220			.044
2009-04	L4 1.5L		IFR5T11	4996	FR5AHX	95839	BKR5EIX-11	5464	BKR5EGP	7090	BKR5E-11	6953	.044
2003-01	L4 1.5L		<b>IFR5T11</b>	<b>4996</b>	FR5AHX	95839	BKR5EIX-11	5464	BKR5EGP	7090	BKR5E-11	6953	.044
<b>Prius Plug-In</b>													
2015	L4 1.8L	To 3/2015	ILKAR7B11	4912	LKAR7AHX-S	92274	LKAR7BIX-11S	93501	LKAR7AGP-D	93220			.044
2014-12	L4 1.8L		ILKAR7B11	4912	LKAR7AHX-S	92274	LKAR7BIX-11S	93501	LKAR7AGP-D	93220			.044
<b>Prius V</b>													
2015	L4 1.8L	To 3/2015	ILKAR7B11	4912	LKAR7AHX-S	92274	LKAR7BIX-11S	93501	LKAR7AGP-D	93220			.044
2014-12	L4 1.8L		ILKAR7B11	4912	LKAR7AHX-S	92274	LKAR7BIX-11S	93501	LKAR7AGP-D	93220			.044



Year	Cyl. L	Notes	Original Equipment		Ruthenium HX		Iridium IX		G-Power		V-Power		Gap
			Part	Stock	Part	Stock	Part	Stock	Part	Stock	Part	Stock	
<b>TOYOTA (Cont'd)</b>													
<b>RAV4</b>													
2017-16	L4 2.5L	GAS	ILFR5T11	96779	LFR5AHX	96355	LFR5AIX-11	4469	LFR5AGP	5018	LFR5A-11	6376	.044
2015-13	L4 2.5L		ILFR5T11	96779	LFR5AHX	96355	LFR5AIX-11	4469	LFR5AGP	5018	LFR5A-11	6376	.044
2012-09	L4 2.5L		ILFR5T11	96779	LFR5AHX	96355	LFR5AIX-11	4469	LFR5AGP	5018	LFR5A-11	6376	.044
	V6 3.5L		DILFR6D11	6176	LFR6AHX-S	94122	LFR6AIX-11	6619	LFR6CGP	1483			.044
2008-06	L4 2.4L		IFR6T11	4589	FR6AHX-S	94279	BKR6EIX-11	3764	BKR6EGP	7092	BKR6E-11	2756	.044
	V6 3.5L		DILFR6D11	6176	LFR6AHX-S	94122	LFR6AIX-11	6619	LFR6CGP	1483			.044
2005	L4 2.4L		IFR6T11	4589	FR6AHX-S	94279	BKR6EIX-11	3764	BKR6EGP	7092	BKR6E-11	2756	.044
2004	L4 2.4L		BKR6EP-11	2978	FR6AHX-S	94279	BKR6EIX-11	3764	BKR6EGP	7092	BKR6E-11	2756	.044
2003-01	L4 2.0L		<b>IFR6T11</b>	<b>4589</b>	FR6AHX-S	94279	BKR6EIX-11	3764	BKR6EGP	7092	BKR6E-11	2756	.044
2000-98	L4 2.0L		<b>BKR6EKP-11</b>	<b>3452</b>	FR6BHX-S	95159	BKR6EIX-11	3764	BKR6EGP	7092	BKR6EYA	7990	.044
1997	L4 2.0L		<b>BKR6EKP-11</b>	<b>3452</b>	FR6AHX-S	94279	BKR6EIX-11	3764	BKR6EGP	7092	BKR6EYA	7990	.044
1996	L4 2.0L		<b>BKR6EP-11</b>	<b>2978</b>			BKR6EIX-11	3764	BKR6EGP	7092	BKR6E-11	2756	.044
<b>Sequoia</b>													
2017-13	V8 5.7L		ILFR6T11	4904	LFR6AHX-S	94122	LFR6AIX-11	6619	LFR6CGP	1483	LFR6C-11	7787	.044
2012-10	V8 4.6L		ILFR6T11	4904	LFR6AHX-S	94122	LFR6AIX-11	6619	LFR6CGP	1483	LFR6C-11	7787	.044
	V8 5.7L		ILFR6T11	4904	LFR6AHX-S	94122	LFR6AIX-11	6619	LFR6CGP	1483	LFR6C-11	7787	.044
2009-08	V8 4.7L		IFR6T11	4589	FR6AHX-S	94279	BKR6EIX-11	3764	BKR6EGP	7092	BKR6E-11	2756	.044
	V8 5.7L		ILFR6T11	4904	LFR6AHX-S	94122	LFR6AIX-11	6619	LFR6CGP	1483	LFR6C-11	7787	.044
2007-05	V8 4.7L		IFR6T11	4589	FR6AHX-S	94279	BKR6EIX-11	3764	BKR6EGP	7092	BKR6E-11	2756	.044
2004-03	V8 4.7L		BKR6EP-8	2215	FR6AHX-S	94279	BKR6EIX	6418	BKR6EGP	7092	BKR6EYA	7990	.032
2002-01	V8 4.7L		<b>BKR6EYA</b>	<b>7990</b>	FR6AHX-S	94279	BKR6EIX	6418	BKR6EGP	7092	BKR6EYA	7990	.032
<b>Sienna</b>													
2016-14	V6 3.5L		DILFR6D11	6176	LFR6AHX-S	94122	LFR6AIX-11	6619	LFR6CGP	1483			.044
2013-11	L4 2.7L		ILFR5T11	96779	LFR5AHX	96355	LFR5AIX-11	4469	LFR5AGP	5018	LFR5A-11	6376	.044
	V6 3.5L		DILFR6D11	6176	LFR6AHX-S	94122	LFR6AIX-11	6619	LFR6CGP	1483			.044
2010-07	V6 3.5L		DILFR6D11	6176	LFR6AHX-S	94122	LFR6AIX-11	6619	LFR6CGP	1483			.044
2006-05	V6 3.3L		IFR6T11	4589	FR6AHX-S	94279	BKR6EIX-11	3764	BKR6EGP	7092	BKR6E-11	2756	.044
2004	V6 3.3L		BKR6EP-11	2978	FR6AHX-S	94279	BKR6EIX-11	3764	BKR6EGP	7092	BKR6E-11	2756	.044
2003-01	V6 3.0L		<b>IFR6T11</b>	<b>4589</b>	FR6AHX-S	94279	BKR6EIX-11	3764	BKR6EGP	7092	BKR6E-11	2756	.044
2000-98	V6 3.0L		<b>BKR6EKP-11</b>	<b>3452</b>	FR6BHX-S	95159	BKR6EIX-11	3764	BKR6EGP	7092	BKR6EYA	7990	.044
<b>Solara</b>													
2008-07	L4 2.4L		IFR6T11	4589	FR6AHX-S	94279	BKR6EIX-11	3764	BKR6EGP	7092	BKR6E-11	2756	.044
	V6 3.3L		IFR6T11	4589	FR6AHX-S	94279	BKR6EIX-11	3764	BKR6EGP	7092	BKR6E-11	2756	.044
2006-05	L4 2.4L		IFR6T11	4589	FR6AHX-S	94279	BKR6EIX-11	3764	BKR6EGP	7092	BKR6E-11	2756	.044
	V6 3.3L		<b>IFR6T11</b>	<b>4589</b>	FR6AHX-S	94279	BKR6EIX-11	3764	BKR6EGP	7092	BKR6E-11	2756	.044
2004	L4 2.4L		BKR6EP-11	2978	FR6AHX-S	94279	BKR6EIX-11	3764	BKR6EGP	7092	BKR6E-11	2756	.044
	V6 3.3L		BKR6EP-11	2978	FR6AHX-S	94279	BKR6EIX-11	3764	BKR6EGP	7092	BKR6E-11	2756	.044
2003-02	L4 2.4L		<b>IFR6T11</b>	<b>4589</b>	FR6AHX-S	94279	BKR6EIX-11	3764	BKR6EGP	7092	BKR6E-11	2756	.044
	V6 3.0L		<b>IFR6T11</b>	<b>4589</b>	FR6BHX-S	95159	BKR6EIX-11	3764	BKR6EGP	7092	BKR6E-11	2756	.044
2001-99	L4 2.2L		<b>BKR6EKP-11</b>	<b>3452</b>	FR6BHX-S	95159	BKR6EIX-11	3764	BKR6EGP	7092	BKR6EYA	7990	.044
	V6 3.0L		<b>BKR6EKP-11</b>	<b>3452</b>	FR6BHX-S	95159	BKR6EIX-11	3764	BKR6EGP	7092	BKR6EYA	7990	.044
<b>Supra</b>													
1998	L6 3.0L	Naturally Aspirated	<b>BKR5EKP-11</b>	<b>4302</b>	FR5BHX	96457	BKR5EIX-11	5464	BKR5EGP	7090	BKR5E-11	6953	.044
		Turbo	<b>BKR6EP-11</b>	<b>2978</b>	FR6BHX-S	95159	BKR6EIX-11	3764	BKR6EGP	7092	BKR6E-11	2756	.044
1997	L6 3.0L	Naturally Aspirated	<b>BKR5EP-11</b>	<b>3440</b>	FR5AHX	95839	BKR5EIX-11	5464	BKR5EGP	7090	BKR5EYA-11	2526	.044
		Turbo	<b>BKR6EP-11</b>	<b>2978</b>	FR6BHX-S	95159	BKR6EIX-11	3764	BKR6EGP	7092	BKR6E-11	2756	.044
1996-93	L6 3.0L	Naturally Aspirated	<b>BKR5EP-11</b>	<b>3440</b>			BKR5EIX-11	5464	BKR5EGP	7090	BKR5EYA-11	2526	.044
		Turbo	<b>BKR6EP-11</b>	<b>2978</b>			BKR6EIX-11	3764	BKR6EGP	7092	BKR6E-11	2756	.044
1992-87	L6 3.0L	Naturally Aspirated	<b>BCPR5EP-11</b>	<b>2097</b>			BCPR5EIX-11	3306	BCPR5EGP	7086	BCPR5EY-11	2441	.044
		Turbo	<b>BCPR6EP-N-8</b>	<b>5275</b>			BCPR6EIX	5689	BCPR6EGP	7088	BCPR6E	3735	.032
1986	L6 3.0L		<b>BCPR5EP-11</b>	<b>2097</b>			BCPR5EIX-11	3306	BCPR5EGP	7086	BCPR5EY-11	2441	.044
<b>T100</b>													
1998	L4 2.7L		<b>BKR5EYA</b>	<b>2087</b>	FR5BHX	96457	BKR5EIX	6341	BKR5EGP	7090	BKR5EYA	2087	.032
	V6 3.4L		<b>BKR5EKB-11</b>	<b>3967</b>	FR5BHX	96457	BKR5EIX-11	5464	BKR5EGP	7090	BKR5E-11	6953	.044
1997	L4 2.7L		<b>BKR5EYA</b>	<b>2087</b>	FR5AHX	95839	BKR5EIX	6341	BKR5EGP	7090	BKR5EYA	2087	.032
	V6 3.4L		<b>BKR5EKB-11</b>	<b>3967</b>	FR5BHX	96457	BKR5EIX-11	5464	BKR5EGP	7090	BKR5E-11	6953	.044
1996-95	L4 2.7L		<b>BKR5EYA</b>	<b>2087</b>			BKR5EIX	6341	BKR5EGP	7090	BKR5EYA	2087	.032

**Bold denotes NGK OE Manufacturer and/or OE Service Part**  
NOT BOLD denotes OE Equivalent Part

**Le texte en gras désigne une pièce d'équipement originale du manufacturier NGK et/ou pièce d'équipement originale de service**  
Le texte non en gras désigne une pièce d'équipement originale équivalente

Note: Due to different operating or engine conditions, alternate heat range plugs may be required.

Note: En raison de différences au niveau du fonctionnement ou des conditions du moteur, d'autres types de bougies avec variation de chaleur peuvent être nécessaires



Year	Cyl. L	Notes	Original Equipment		Ruthenium HX		Iridium IX		G-Power		V-Power		Gap
			Part	Stock	Part	Stock	Part	Stock	Part	Stock	Part	Stock	
<b>TOYOTA (Cont'd)</b>													
<b>T100 (Cont'd)</b>													
1996-95	V6 3.4L		<b>BKR5EKB-11</b>	<b>3967</b>			BKR5EIX-11	5464	BKR5EGP	7090	BKR5E-11	6953	.044
1994	L4 2.7L		<b>BKR5EYA</b>	<b>2087</b>			BKR5EIX	6341	BKR5EGP	7090	BKR5EYA	2087	.032
	V6 3.0L		<b>BKR5EYA</b>	<b>2087</b>			BKR5EIX	6341	BKR5EGP	7090	BKR5EYA	2087	.032
1993	V6 3.0L		<b>BKR5EYA</b>	<b>2087</b>			BKR5EIX	6341	BKR5EGP	7090	BKR5EYA	2087	.032
<b>Tacoma</b>													
2015-05	L4 2.7L		ILFR6T11	4904	LFR6AHX-S	94122	LFR6AIX-11	6619	LFR6CGP	1483	LFR6C-11	7787	.044
	V6 4.0L		<b>LFR6C-11</b>	<b>7787</b>	LFR6AHX-S	94122	LFR6AIX-11	6619	LFR6CGP	1483	LFR6C-11	7787	.044
2004-03	L4 2.4L		<b>IFR5T11</b>	<b>4996</b>	FR5AHX	95839	BKR5EIX-11	5464	BKR5EGP	7090	BKR5EYA-11	2526	.044
	L4 2.7L		BKR5EYA-11	2526	FR5AHX	95839	BKR5EIX-11	5464	BKR5EGP	7090	BKR5EYA-11	2526	.044
	V6 3.4L		<b>BKR5EKB-11</b>	<b>3967</b>	FR5BHX	96457	BKR5EIX-11	5464	BKR5EGP	7090	BKR5E-11	6953	.044
2002-01	L4 2.4L		<b>BKR5EYA-11</b>	<b>2526</b>	FR5AHX	95839	BKR5EIX-11	5464	BKR5EGP	7090	BKR5EYA-11	2526	.044
	L4 2.7L		BKR5EYA-11	2526	FR5AHX	95839	BKR5EIX-11	5464	BKR5EGP	7090	BKR5EYA-11	2526	.044
	V6 3.4L		<b>BKR5EKB-11</b>	<b>3967</b>	FR5BHX	96457	BKR5EIX-11	5464	BKR5EGP	7090	BKR5E-11	6953	.044
2000	L4 2.4L		<b>BKR5EYA-11</b>	<b>2526</b>	FR5BHX	96457	BKR5EIX-11	5464	BKR5EGP	7090	BKR5EYA-11	2526	.044
	L4 2.7L	w/OE # 90919-01164 (0.044" Gap)	BKR5EYA-11	2526	FR5BHX	96457	BKR5EIX-11	5464	BKR5EGP	7090	BKR5EYA-11	2526	.044
		w/OE # 90919-01176 (0.032" Gap)	BKR5EYA	2087	FR5BHX	96457	BKR5EIX	6341	BKR5EGP	7090	BKR5EYA	2087	.032
	V6 3.4L		<b>BKR5EKB-11</b>	<b>3967</b>	FR5BHX	96457	BKR5EIX-11	5464	BKR5EGP	7090	BKR5E-11	6953	.044
1999	L4 2.4L		<b>BKR5EYA</b>	<b>2087</b>	FR5BHX	96457	BKR5EIX	6341	BKR5EGP	7090	BKR5EYA	2087	.032
	L4 2.7L	w/OE # 90919-01164 (0.044" Gap)	BKR5EYA-11	2526	FR5BHX	96457	BKR5EIX-11	5464	BKR5EGP	7090	BKR5EYA-11	2526	.044
		w/OE # 90919-01176 (0.032" Gap)	BKR5EYA	2087	FR5BHX	96457	BKR5EIX	6341	BKR5EGP	7090	BKR5EYA	2087	.032
	V6 3.4L		<b>BKR5EKB-11</b>	<b>3967</b>	FR5BHX	96457	BKR5EIX-11	5464	BKR5EGP	7090	BKR5E-11	6953	.044
1998	L4 2.4L		<b>BKR5EYA</b>	<b>2087</b>	FR5BHX	96457	BKR5EIX	6341	BKR5EGP	7090	BKR5EYA	2087	.032
	L4 2.7L		BKR5EYA	2087	FR5BHX	96457	BKR5EIX	6341	BKR5EGP	7090	BKR5EYA	2087	.032
	V6 3.4L		<b>BKR5EKB-11</b>	<b>3967</b>	FR5BHX	96457	BKR5EIX-11	5464	BKR5EGP	7090	BKR5E-11	6953	.044
1997	L4 2.4L		<b>BKR5EYA</b>	<b>2087</b>	FR5AHX	95839	BKR5EIX	6341	BKR5EGP	7090	BKR5EYA	2087	.032
	L4 2.7L		BKR5EYA	2087	FR5BHX	96457	BKR5EIX	6341	BKR5EGP	7090	BKR5EYA	2087	.032
	V6 3.4L		<b>BKR5EKB-11</b>	<b>3967</b>	FR5BHX	96457	BKR5EIX-11	5464	BKR5EGP	7090	BKR5E-11	6953	.044
1996-95	L4 2.4L		<b>BKR5EYA</b>	<b>2087</b>			BKR5EIX	6341	BKR5EGP	7090	BKR5EYA	2087	.032
	L4 2.7L		BKR5EYA	2087			BKR5EIX	6341	BKR5EGP	7090	BKR5EYA	2087	.032
	V6 3.4L		<b>BKR5EKB-11</b>	<b>3967</b>			BKR5EIX-11	5464	BKR5EGP	7090	BKR5E-11	6953	.044
<b>Tercel</b>													
1999-97	L4 1.5L		<b>BKR5EKB-11</b>	<b>3967</b>	FR5BHX	96457	BKR5EIX-11	5464	BKR5EGP	7090	BKR5E-11	6953	.044
1996-95	L4 1.5L		<b>BKR5EKB-11</b>	<b>3967</b>			BKR5EIX-11	5464	BKR5EGP	7090	BKR5E-11	6953	.044
1994-85	L4 1.5L		BPR5ES-11	7634			BPR5EIX-11	2115	BPR5EGP	7082	BPR5EY-11	6937	.044
<b>Tundra</b>													
2017-15	V8 4.6L		ILFR6T11	4904	LFR6AHX-S	94122	LFR6AIX-11	6619	LFR6CGP	1483	LFR6C-11	7787	.044
	V8 5.7L		ILFR6T11	4904	LFR6AHX-S	94122	LFR6AIX-11	6619	LFR6CGP	1483	LFR6C-11	7787	.044
2014	V6 4.0L		ILFR5T11	96779	LFR5AHX	96355	LFR5AIX-11	4469	LFR5AGP	5018	LFR5A-11	6376	.044
	V8 4.6L		ILFR6T11	4904	LFR6AHX-S	94122	LFR6AIX-11	6619	LFR6CGP	1483	LFR6C-11	7787	.044
	V8 5.7L		ILFR6T11	4904	LFR6AHX-S	94122	LFR6AIX-11	6619	LFR6CGP	1483	LFR6C-11	7787	.044
	V8 5.7L		ILFR6T11	4904	LFR6AHX-S	94122	LFR6AIX-11	6619	LFR6CGP	1483	LFR6C-11	7787	.044
2013	V6 4.0L	From 6/2013	ILFR5T11	96779	LFR5AHX	96355	LFR5AIX-11	4469	LFR5AGP	5018	LFR5A-11	6376	.044
		To 6/2013	ILFR6T11	4904	LFR6AHX-S	94122	LFR6AIX-11	6619	LFR6CGP	1483	LFR6C-11	7787	.044
	V8 4.6L		ILFR6T11	4904	LFR6AHX-S	94122	LFR6AIX-11	6619	LFR6CGP	1483	LFR6C-11	7787	.044
	V8 5.7L		ILFR6T11	4904	LFR6AHX-S	94122	LFR6AIX-11	6619	LFR6CGP	1483	LFR6C-11	7787	.044
2012-11	V6 4.0L		ILFR6T11	4904	LFR6AHX-S	94122	LFR6AIX-11	6619	LFR6CGP	1483	LFR6C-11	7787	.044
	V8 4.6L		ILFR6T11	4904	LFR6AHX-S	94122	LFR6AIX-11	6619	LFR6CGP	1483	LFR6C-11	7787	.044
	V8 5.7L		ILFR6T11	4904	LFR6AHX-S	94122	LFR6AIX-11	6619	LFR6CGP	1483	LFR6C-11	7787	.044
2010	V6 4.0L		<b>LFR6C-11</b>	<b>7787</b>	LFR6AHX-S	94122	LFR6AIX-11	6619	LFR6CGP	1483	LFR6C-11	7787	.044
	V8 4.6L		ILFR6T11	4904	LFR6AHX-S	94122	LFR6AIX-11	6619	LFR6CGP	1483	LFR6C-11	7787	.044
	V8 5.7L		ILFR6T11	4904	LFR6AHX-S	94122	LFR6AIX-11	6619	LFR6CGP	1483	LFR6C-11	7787	.044
2009-07	V6 4.0L		<b>LFR6C-11</b>	<b>7787</b>	LFR6AHX-S	94122	LFR6AIX-11	6619	LFR6CGP	1483	LFR6C-11	7787	.044
	V8 4.7L		IFR6T11	4589	FR6AHX-S	94279	BKR6EIX-11	3764	BKR6EGP	7092	BKR6E-11	2756	.044
	V8 5.7L		ILFR6T11	4904	LFR6AHX-S	94122	LFR6AIX-11	6619	LFR6CGP	1483	LFR6C-11	7787	.044
2006-05	V6 4.0L		<b>LFR6C-11</b>	<b>7787</b>	LFR6AHX-S	94122	LFR6AIX-11	6619	LFR6CGP	1483	LFR6C-11	7787	.044



Year	Cyl. L	Notes	Original Equipment		Ruthenium HX		Iridium IX		G-Power		V-Power		Gap
			Part	Stock	Part	Stock	Part	Stock	Part	Stock	Part	Stock	
<b>TOYOTA (Cont'd)</b>													
<b>Tundra (Cont'd)</b>													
2006-05	V8 4.7L		IFR6T11	4589	FR6AHX-S	94279	BKR6EIX-11	3764	BKR6EGP	7092	BKR6E-11	2756	.044
2004-03	V6 3.4L		<b>BKR5EKB-11</b>	<b>3967</b>	FR5BHX	96457	BKR5EIX-11	5464	BKR5EGP	7090	BKR5E-11	6953	.044
	V8 4.7L		BKR6EP-8	2215	FR6AHX-S	94279	BKR6EIX	6418	BKR6EGP	7092	BKR6EYA	7990	.032
2002-00	V6 3.4L		<b>BKR5EKB-11</b>	<b>3967</b>	FR5BHX	96457	BKR5EIX-11	5464	BKR5EGP	7090	BKR5E-11	6953	.044
	V8 4.7L		<b>BKR6EYA</b>	<b>7990</b>	FR6AHX-S	94279	BKR6EIX	6418	BKR6EGP	7092	BKR6EYA	7990	.032
<b>Van</b>													
1989-86	L4 2.2L		<b>BPR5EP-11</b>	<b>3971</b>			BPR5EIX-11	2115	BPR5EGP	7082	BPR5EY-11	6937	.044
1985	L4 2.0L		<b>BPR5EP-11</b>	<b>3971</b>			BPR5EIX-11	2115	BPR5EGP	7082	BPR5EY-11	6937	.044
<b>Van Wagon</b>													
1988	L4 2.2L		<b>BPR5EY</b>	<b>1233</b>			BPR5EIX	6597	BPR5EGP	7082	BPR5EY	1233	.032
<b>Venza</b>													
2016-09	L4 2.7L		ILFR5T11	96779	LFR5AHX	96355	LFR5AIX-11	4469	LFR5AGP	5018	LFR5A-11	6376	.044
	V6 3.5L		DILFR6D11	6176	LFR6AHX-S	94122	LFR6AIX-11	6619	LFR6CGP	1483			.044
<b>Yaris</b>													
2018-16	L4 1.5L	Hatchback	IFR5T11	4996	FR5AHX	95839	BKR5EIX-11	5464	BKR5EGP	7090	BKR5EYA-11	2526	.044
		Sedan	ILKAR7L11	94124	LKAR7AHX-S	92274	LKAR7BIX-11S	93501	LKAR7AGP-D	93220			.040
2015	L4 1.5L		IFR5T11	4996	FR5AHX	95839	BKR5EIX-11	5464	BKR5EGP	7090	BKR5EYA-11	2526	.044
2014-11	L4 1.5L		IFR5T11	4996	FR5AHX	95839	BKR5EIX-11	5464	BKR5EGP	7090	BKR5E-11	6953	.044
2010	L4 1.5L		IFR5T11	4996	FR5AHX	95839	BKR5EIX-11	5464	BKR5EGP	7090	BKR5EYA-11	2526	.044
2009-06	L4 1.5L		IFR5T11	4996	FR5AHX	95839	BKR5EIX-11	5464	BKR5EGP	7090	BKR5E-11	6953	.044
<b>Yaris iA</b>													
2018-17	L4 1.5L	Sedan	ILKAR7L11	94124	LKAR7AHX-S	92274	LKAR7BIX-11S	93501	LKAR7AGP-D	93220			.040
<b>VOLKSWAGEN</b>													
<b>Beetle</b>													
2018	L4 2.0L		<b>PLFER7A8EG</b>	<b>94833</b>	LFER7BHX	95125							.032
2017-16	L4 1.8L		<b>PLFER7A8EG</b>	<b>94833</b>	LFER7BHX	95125							.032
	L4 2.0L		<b>PLFER7A8EG</b>	<b>94833</b>	LFER7BHX	95125							.032
2015	L4 1.8L		<b>PLFER7A8EG</b>	<b>94833</b>	LFER7BHX	95125							.032
	L4 2.0L	GAS	<b>PLFER7A8EG</b>	<b>94833</b>	LFER7BHX	95125							.032
2014	L4 1.8L		<b>PLFER7A8EG</b>	<b>94833</b>	LFER7BHX	95125							.032
	L4 2.0L	GAS	<b>PLFER7A8EG</b>	<b>94833</b>	LFER7BHX	95125							.032
	L5 2.5L		ZFR6T-11G	5960									.044
2013	L4 2.0L	GAS, Eng Desg CBFA	<b>PFR7S8EG</b>	<b>1675</b>	FR7BHX-S	92400	BKR7EIX	2667					.032
		GAS, Eng Desg CCTA	<b>PFR7S8EG</b>	<b>1675</b>	FR7BHX-S	92400	BKR7EIX	2667					.032
		GAS, Eng Desg CPLA	<b>PLFER7A8EG</b>	<b>94833</b>	LFER7BHX	95125							.032
	L5 2.5L		ZFR6T-11G	5960									.044
2012	L4 2.0L		<b>PFR7S8EG</b>	<b>1675</b>	FR7BHX-S	92400	BKR7EIX	2667					.032
	L5 2.5L		ZFR6T-11G	5960									.044
2010-09	L5 2.5L		ZFR6T-11G	5960									.044
2008	L5 2.5L	From Chassis #s 1C-8-517 070 or 1Y-8-415 652	ZFR6T-11G	5960									.044
		To Chassis #s 1C-8-517 069 or 1Y-8-415 651	<b>PZFR5Q-11</b>	<b>6737</b>			ZFR5AIX-11	94553	ZFR5BGP	90804			.044
2007-06	L4 1.9L	DIESEL	<b>CZ104</b>	<b>9810</b>									
	L5 2.5L		<b>PZFR5Q-11</b>	<b>6737</b>			ZFR5AIX-11	94553	ZFR5BGP	90804			.044
2005	L4 1.8L		<b>PFR6Q</b>	<b>6458</b>			BKR6EIX	6418					.032
	L4 1.9L	DIESEL	<b>CZ104</b>	<b>9810</b>									
	L4 2.0L		<b>PZFR5D-11</b>	<b>7968</b>			ZFR5AIX-11	94553	ZFR5BGP	90804			.044
2004	L4 1.8L		<b>PFR6Q</b>	<b>6458</b>			BKR6EIX	6418					.032
	L4 1.9L	DIESEL, Eng Desg BEW	<b>CZ104</b>	<b>9810</b>									
	L4 2.0L	Eng Desg BEV	<b>PZFR5D-11</b>	<b>7968</b>			ZFR5AIX-11	94553	ZFR5BGP	90804			.044
		Eng Desg BGD	<b>BKR5E-11</b>	<b>6953</b>	FR5BHX	96457	BKR5EIX-11	5464	BKR5EGP	7090	BKR5E-11	6953	.044
2003	L4 1.8L		<b>PFR6Q</b>	<b>6458</b>			BKR6EIX	6418					.032
	L4 1.9L	DIESEL	Y-732J	5909									

**Bold denotes NGK OE Manufacturer and/or OE Service Part**  
 NOT BOLD denotes OE Equivalent Part

Note: Due to different operating or engine conditions, alternate heat range plugs may be required.

**Le texte en gras désigne une pièce d'équipement originale du manufacturier NGK et/ou pièce d'équipement originale de service**  
 Le texte non en gras désigne une pièce d'équipement originale équivalente

Note: En raison de différences au niveau du fonctionnement ou des conditions du moteur, d'autres types de bougies avec variation de chaleur peuvent être nécessaires





Year	Cyl. L	Notes	Original Equipment		Ruthenium HX		Iridium IX		G-Power		V-Power		Gap
			Part	Stock	Part	Stock	Part	Stock	Part	Stock	Part	Stock	
<b>VOLKSWAGEN (Cont'd)</b>													
<b>Beetle (Cont'd)</b>													
2003	L4 2.0L	Eng Desg AVH	<b>PZFR5D-11</b>	<b>7968</b>			ZFR5AIX-11	94553	ZFR5BGP	90804			.044
		Eng Desg AZG	<b>PZFR5D-11</b>	<b>7968</b>			ZFR5AIX-11	94553	ZFR5BGP	90804			.044
		Eng Desg BDC	BKUR6ET-10	2397	FR6BHX-S	95159	BKR6EIX	6418	BKR6EGP	7092	BKR6E	6962	.040
2002	L4 1.8L	Eng Desg AWP	<b>PFR6Q</b>	<b>6458</b>			BKR6EIX	6418					.032
		Eng Desg AWV	PFR6Q	6458			BKR6EIX	6418					.032
	L4 1.9L	DIESEL	Y-732J	5909									
	L4 2.0L	Eng Desg AVH	<b>PZFR5D-11</b>	<b>7968</b>			ZFR5AIX-11	94553	ZFR5BGP	90804			.040
		Eng Desg AZG	<b>PZFR5D-11</b>	<b>7968</b>			ZFR5AIX-11	94553	ZFR5BGP	90804			.044
2001	L4 1.8L		<b>PFR6Q</b>	<b>6458</b>			BKR6EIX	6418					.032
	L4 1.9L	DIESEL	Y-732J	5909									
	L4 2.0L	Eng Desg AEG	<b>BKUR6ET-10</b>	<b>2397</b>	FR6BHX-S	95159	BKR6EIX	6418	BKR6EGP	7092	BKR6E	6962	.040
		Eng Desg AVH	<b>PZFR5D-11</b>	<b>7968</b>			ZFR5AIX-11	94553	ZFR5BGP	90804			.044
2000-99	L4 1.8L		<b>PFR6Q</b>	<b>6458</b>			BKR6EIX	6418					.032
		L4 1.9L	DIESEL	Y-732J	5909								
	L4 2.0L		<b>BKUR6ET-10</b>	<b>2397</b>	FR6BHX-S	95159							.040
1998	L4 1.9L	DIESEL	Y-732J	5909									
	L4 2.0L		<b>BKUR6ET-10</b>	<b>2397</b>	FR6BHX-S	95159							.040
<b>Cabrio</b>													
2002	L4 2.0L		<b>PFR6Q</b>	<b>6458</b>			BKR6EIX	6418					.032
2001-97	L4 2.0L		BKR5E	7938	FR5AHX	95839	BKR5EIX	6341	BKR5EGP	7090	BKR5E	7938	.028
1996-95	L4 2.0L		BKR5E	7938			BKR5EIX	6341	BKR5EGP	7090	BKR5E	7938	.028
<b>Cabriolet</b>													
1993-85	L4 1.8L		BPR6ES	7131			BPR6EIX	6637	BPR6EGP	7084	BPR6EY	6427	.028
<b>CC</b>													
2017-16	L4 2.0L		<b>PFR7S8EG</b>	<b>1675</b>	FR7BHX-S	92400	BKR7EIX	2667					.032
	V6 3.6L		<b>ILZKR7A</b>	<b>1961</b>									.036
2015-13	L4 2.0L	GAS	<b>PFR7S8EG</b>	<b>1675</b>	FR7BHX-S	92400	BKR7EIX	2667					.032
	V6 3.6L		<b>ILZKR7A</b>	<b>1961</b>									.036
2012-09	L4 2.0L		<b>PFR7S8EG</b>	<b>1675</b>	FR7BHX-S	92400	BKR7EIX	2667					.032
	V6 3.6L		<b>ILZKR7A</b>	<b>1961</b>									.036
<b>Corrado</b>													
1995-93	V6 2.8L		<b>BKR5EKU</b>	<b>3964</b>			BKR5EIX	6341	BKR5EGP	7090	BKR5E	7938	.028
1992	L4 1.8L		BPR6ES	7131			BPR6EIX	6637	BPR6EGP	7084	BPR6EY	6427	.024
	V6 2.8L		<b>BKR5EKU</b>	<b>3964</b>			BKR5EIX	6341	BKR5EGP	7090	BKR5E	7938	.028
1991-90	L4 1.8L		BPR6ES	7131			BPR6EIX	6637	BPR6EGP	7084	BPR6EY	6427	.024
<b>Eos</b>													
2016-09	L4 2.0L		<b>PFR7S8EG</b>	<b>1675</b>	FR7BHX-S	92400	BKR7EIX	2667					.032
2008-07	L4 2.0L		PFR7S8EG	1675	FR7BHX-S	92400	BKR7EIX	2667					.032
	V6 3.2L		<b>IZKR7B</b>	<b>7563</b>									.036
<b>EuroVan</b>													
2003	V6 2.8L		<b>BKR5EKUP</b>	<b>2890</b>	FR5AHX	95839	BKR5EIX	6341	BKR5EGP	7090	BKR5E	7938	.028
2002	V6 2.8L		<b>PZFR5D-11</b>	<b>7968</b>			ZFR5AIX-11	94553	ZFR5BGP	90804			.044
2001	V6 2.8L	Eng Desg. AES	<b>BKR5EKUP</b>	<b>2890</b>	FR5AHX	95839	BKR5EIX	6341	BKR5EGP	7090	BKR5E	7938	.028
		Eng Desg AXK	<b>PZFR5D-11</b>	<b>7968</b>			ZFR5AIX-11	94553	ZFR5BGP	90804			.044
2000-99	V6 2.8L		<b>BKR5EKUP</b>	<b>2890</b>	FR5BHX	96457	BKR5EIX	6341	BKR5EGP	7090	BKR5E	7938	.028
1997	L5 2.4L	DIESEL	Y-918J	3704									
	V6 2.8L		<b>BKR5EKUP</b>	<b>2890</b>	FR5BHX	96457	BKR5EIX	6341	BKR5EGP	7090	BKR5E	7938	.028
1996-93	L5 2.4L	DIESEL	Y-918J	3704									
	L5 2.5L		BP6ET	1263									.032
1992	L5 2.5L		BP6ET	1263									.032
<b>Fox</b>													
1993-87	L4 1.8L		BP6ET	1263									.032
<b>Golf</b>													
2017-15	L4 1.8L		<b>PLFER7A8EG</b>	<b>94833</b>	LFER7BHX	95125							.032
2014	L5 2.5L		ZFR6T-11G	5960									.044
2013	L4 2.0L	GAS	<b>PFR7S8EG</b>	<b>1675</b>	FR7BHX-S	92400	BKR7EIX	2667					.032





Year	Cyl. L	Notes	Original Equipment		Ruthenium HX		Iridium IX		G-Power		V-Power		Gap
			Part	Stock	Part	Stock	Part	Stock	Part	Stock	Part	Stock	
<b>VOLKSWAGEN (Cont'd)</b>													
<b>Golf (Cont'd)</b>													
2013	L5 2.5L		ZFR6T-11G	5960									.044
2012-10	L5 2.5L		ZFR6T-11G	5960									.044
2006	L4 1.8L		<b>PFR6Q</b>	<b>6458</b>			BKR6EIX	6418					.032
	L4 1.9L	DIESEL	<b>CZ104</b>	<b>9810</b>									
	L4 2.0L	Naturally Aspirated	<b>PZFR5D-11</b>	<b>7968</b>			ZFR5AIX-11	94553	ZFR5BGP	90804			.044
2005	L4 1.8L		<b>PFR6Q</b>	<b>6458</b>			BKR6EIX	6418					.032
	L4 1.9L	DIESEL	<b>CZ104</b>	<b>9810</b>									
	L4 2.0L		<b>PZFR5D-11</b>	<b>7968</b>			ZFR5AIX-11	94553	ZFR5BGP	90804			.044
2004	V6 2.8L		<b>PZFR5D-11</b>	<b>7968</b>			ZFR5AIX-11	94553	ZFR5BGP	90804			.044
	L4 1.8L		<b>PFR6Q</b>	<b>6458</b>			BKR6EIX	6418					.032
	L4 1.9L	DIESEL, Eng Desg ALH	Y-732J	5909									
		DIESEL, Eng Desg BEW	<b>CZ104</b>	<b>9810</b>									
	L4 2.0L		<b>PZFR5D-11</b>	<b>7968</b>			ZFR5AIX-11	94553	ZFR5BGP	90804			.044
2003	V6 2.8L		<b>PZFR5D-11</b>	<b>7968</b>			ZFR5AIX-11	94553	ZFR5BGP	90804			.044
	V6 3.2L		<b>IZKR7B</b>	<b>7563</b>									.032
	L4 1.8L		<b>PFR6Q</b>	<b>6458</b>			BKR6EIX	6418					.032
	L4 1.9L	DIESEL	Y-732J	5909									
	L4 2.0L		<b>PZFR5D-11</b>	<b>7968</b>			ZFR5AIX-11	94553	ZFR5BGP	90804			.044
	V6 2.8L		<b>PZFR5D-11</b>	<b>7968</b>			ZFR5AIX-11	94553	ZFR5BGP	90804			.044
2002	L4 1.8L		<b>PFR6Q</b>	<b>6458</b>			BKR6EIX	6418					.032
	L4 1.9L	DIESEL	Y-732J	5909									
	L4 2.0L	Eng Desg AVH	<b>PZFR5D-11</b>	<b>7968</b>			ZFR5AIX-11	94553	ZFR5BGP	90804			.044
		Eng Desg AZG	<b>PZFR5D-11</b>	<b>7968</b>			ZFR5AIX-11	94553	ZFR5BGP	90804			.044
2001	V6 2.8L	DOHC, Eng Desg BDF	<b>PZFR5D-11</b>	<b>7968</b>			ZFR5AIX-11	94553	ZFR5BGP	90804			.044
		SOHC, Eng Desg AFP	<b>BKR5EKUP</b>	<b>2890</b>	FR5BHX	96457	BKR5EIX	6341	BKR5EGP	7090	BKR5E	7938	.028
	L4 1.8L		<b>PFR6Q</b>	<b>6458</b>			BKR6EIX	6418					.032
	L4 1.9L	DIESEL	Y-732J	5909									
	L4 2.0L	Eng Desg AEG	<b>BKUR6ET-10</b>	<b>2397</b>	FR6BHX-S	95159	BKR6EIX	6418	BKR6EGP	7092	BKR6E	6962	.040
2000		Eng Desg AVH	<b>PZFR5D-11</b>	<b>7968</b>			ZFR5AIX-11	94553	ZFR5BGP	90804			.044
		Eng Desg AZG	<b>PZFR5D-11</b>	<b>7968</b>			ZFR5AIX-11	94553	ZFR5BGP	90804			.044
	V6 2.8L		BKR5EKUP	2890	FR5BHX	96457	BKR5EIX	6341	BKR5EGP	7090	BKR5E	7938	.028
	L4 1.8L		<b>PFR6Q</b>	<b>6458</b>			BKR6EIX	6418					.032
	L4 1.9L	DIESEL	Y-732J	5909									
	L4 2.0L		<b>BKUR6ET-10</b>	<b>2397</b>	FR6BHX-S	95159							.040
1999	V6 2.8L		<b>BKR6EKUB</b>	<b>7969</b>	FR6BHX-S	95159	BKR6EIX	6418	BKR6EGP	7092	BKR6E	6962	.032
	L4 1.9L	DIESEL	Y-732J	5909									
	L4 2.0L	Eng Desg ABA	BKR5ES	2460	FR5BHX	96457	BKR5EIX	6341	BKR5EGP	7090	BKR5E	7938	.028
1998		Eng Desg AEG	<b>BKUR6ET-10</b>	<b>2397</b>	FR6BHX-S	95159							.040
	V6 2.8L		BKR5EKU	3964	FR5BHX	96457	BKR5EIX	6341	BKR5EGP	7090	BKR5E	7938	.028
	L4 1.8L		<b>BUR6ET</b>	<b>7517</b>									.032
	L4 1.9L	DIESEL, Eng Desg AAZ	Y-918J	3704									
		DIESEL, Eng Desg AHU	Y-732J	5909									
1997	L4 2.0L		BKR5E	7938	FR5AHX	95839	BKR5EIX	6341	BKR5EGP	7090	BKR5E	7938	.028
	V6 2.8L		<b>BKR5EKU</b>	<b>3964</b>	FR5BHX	96457	BKR5EIX	6341	BKR5EGP	7090	BKR5E	7938	.028
	L4 1.8L		<b>BUR6ET</b>	<b>7517</b>									.032
	L4 1.9L	DIESEL, Eng Desg AAZ	Y-918J	3704									
		DIESEL, Eng Desg AHU	Y-732J	5909									
1996-95	L4 2.0L		BKR5E	7938	FR5AHX	95839	BKR5EIX	6341	BKR5EGP	7090	BKR5E	7938	.028
	V6 2.8L		BKR5EKU	3964	FR5BHX	96457	BKR5EIX	6341	BKR5EGP	7090	BKR5E	7938	.028
	L4 1.8L		<b>BUR6ET</b>	<b>7517</b>									.032
1996-95	L4 1.9L	DIESEL	Y-918J	3704									
	L4 2.0L		BKR5E	7938			BKR5EIX	6341	BKR5EGP	7090	BKR5E	7938	.028

**Bold denotes NGK OE Manufacturer and/or OE Service Part**  
NOT BOLD denotes OE Equivalent Part

**Le texte en gras désigne une pièce d'équipement originale du manufacturier NGK et/ou pièce d'équipement originale de service**  
Le texte non en gras désigne une pièce d'équipement originale équivalente

Note: Due to different operating or engine conditions, alternate heat range plugs may be required.

Note: En raison de différences au niveau du fonctionnement ou des conditions du moteur, d'autres types de bougies avec variation de chaleur peuvent être nécessaires



Year	Cyl. L	Notes	Original Equipment		Ruthenium HX		Iridium IX		G-Power		V-Power		Gap
			Part	Stock	Part	Stock	Part	Stock	Part	Stock	Part	Stock	
<b>VOLKSWAGEN (Cont'd)</b>													
<b>Golf (Cont'd)</b>													
1996-95	V6 2.8L		<b>BKR5EKU</b>	<b>3964</b>			BKR5EIX	6341	BKR5EGP	7090	BKR5E	7938	.028
1994	L4 1.8L		<b>BUR6ET</b>	<b>7517</b>									.032
	L4 1.9L	DIESEL	Y-918J	3704									
	L4 2.0L		BKR5E	7938			BKR5EIX	6341	BKR5EGP	7090	BKR5E	7938	.028
1993	L4 1.8L		<b>BUR6ET</b>	<b>7517</b>									.032
	L4 1.9L	DIESEL	Y-918J	3704									
	L4 2.0L		BKR6ES	6364			BKR6EIX	6418	BKR6EGP	7092	BKR6E	6962	.028
1992-90	L4 1.6L	DIESEL	Y-918J	3704									
	L4 1.8L		BPR6ES	7131			BPR6EIX	6637	BPR6EGP	7084	BPR6EY	6427	.028
	L4 2.0L		BKR6E	6962			BKR6EIX	6418	BKR6EGP	7092	BKR6E	6962	.028
1989-88	L4 1.6L	DIESEL	Y-918J	3704									
	L4 1.8L	Eng Desg PF	BPR6ES	7131			BPR6EIX	6637	BPR6EGP	7084	BPR6EY	6427	.028
		Eng Desg PL	<b>BKUR7ET</b>	<b>5496</b>									.032
		Eng Desg RV	BPR6ES	7131			BPR6EIX	6637	BPR6EGP	7084	BPR6EY	6427	.028
1987	L4 1.6L	DIESEL	Y-918J	3704									
	L4 1.8L	Eng Desg GX	BP6ET	1263									.032
		Eng Desg PL	<b>BKUR7ET</b>	<b>5496</b>									.032
		Eng Desg RD	BP6ET	1263									.032
1986	L4 1.6L	DIESEL	Y-918J	3704									
	L4 1.8L	Eng Desg GX	BPR6ES	7131			BPR6EIX	6637	BPR6EGP	7084	BPR6EY	6427	.028
		Eng Desg HT	BKR6ES	6364			BKR6EIX	6418	BKR6EGP	7092	BKR6E	6962	.028
		Eng Desg RD	BKR6ES	6364			BKR6EIX	6418	BKR6EGP	7092	BKR6E	6962	.028
1985	L4 1.6L	DIESEL	Y-918J	3704									
	L4 1.8L	Eng Desg GX	BPR6ES	7131			BPR6EIX	6637	BPR6EGP	7084	BPR6EY	6427	.032
		Eng Desg HT	BP6ET	1263									.032
		Eng Desg RD	BP6ET	1263									.032
<b>Golf Alltrack</b>													
2017	L4 1.8L		<b>PLFER7A8EG</b>	<b>94833</b>	LFER7BHX	95125							.032
<b>Golf City</b>													
2010	L4 2.0L	GAS, Naturally Aspirated	<b>PZFR5D-11</b>	<b>7968</b>			ZFR5AIX-11	94553	ZFR5BGP	90804			.044
2009-07	L4 2.0L	Naturally Aspirated	<b>PZFR5D-11</b>	<b>7968</b>			ZFR5AIX-11	94553	ZFR5BGP	90804			.044
<b>Golf R</b>													
2017-15	L4 2.0L	GAS	<b>PLFER7A8EG</b>	<b>94833</b>	LFER7BHX	95125							.032
2013-12	L4 2.0L	GAS	<b>PFR7S8EG</b>	<b>1675</b>	FR7BHX-S	92400	BKR7EIX	2667					.032
<b>Golf SportWagen</b>													
2017-15	L4 1.8L		<b>PLFER7A8EG</b>	<b>94833</b>	LFER7BHX	95125							.032
<b>GTI</b>													
2017-15	L4 2.0L	GAS, Turbo	<b>PLFER7A8EG</b>	<b>94833</b>	LFER7BHX	95125							.032
2014-10	L4 2.0L	GAS, Turbo	<b>PFR7S8EG</b>	<b>1675</b>	FR7BHX-S	92400	BKR7EIX	2667					.032
2009-06	L4 2.0L	Turbo	<b>PFR7S8EG</b>	<b>1675</b>	FR7BHX-S	92400	BKR7EIX	2667					.032
<b>Jetta</b>													
2017-16	L4 1.8L		<b>PLFER7A8EG</b>	<b>94833</b>	LFER7BHX	95125							.032
	L4 2.0L		<b>PLFER7A8EG</b>	<b>94833</b>	LFER7BHX	95125							.032
2015	L4 1.8L		<b>PLFER7A8EG</b>	<b>94833</b>	LFER7BHX	95125							.032
	L4 2.0L	GAS, Naturally Aspirated, Eng Desg CBPA	ZFR6T-11G	5960									.044
		GAS, Turbo, Eng Desg CPLA	<b>PLFER7A8EG</b>	<b>94833</b>	LFER7BHX	95125							.032
		GAS, Turbo, Eng Desg CPPA	<b>PLFER7A8EG</b>	<b>94833</b>									.032
2014	L4 1.8L		<b>PLFER7A8EG</b>	<b>94833</b>	LFER7BHX	95125							.032
	L4 2.0L	GAS, Naturally Aspirated, Eng Desg CBPA	ZFR6T-11G	5960									.044
		GAS, Turbo, Eng Desg CPLA	<b>PLFER7A8EG</b>	<b>94833</b>	LFER7BHX	95125							.032
		GAS, Turbo, Eng Desg CPPA	<b>PLFER7A8EG</b>	<b>94833</b>									.032



Year	Cyl. L	Notes	Original Equipment		Ruthenium HX		Iridium IX		G-Power		V-Power		Gap
			Part	Stock	Part	Stock	Part	Stock	Part	Stock	Part	Stock	
<b>VOLKSWAGEN (Cont'd)</b>													
<b>Jetta (Cont'd)</b>													
2014	L5 2.5L		ZFR6T-11G	5960									.044
2013	L4 2.0L	GAS, Naturally Aspirated, Eng Desg CBPA	ZFR6T-11G	5960									.044
		GAS, Turbo, Eng Desg CBFA	<b>PFR7S8EG</b>	<b>1675</b>	FR7BHX-S	92400	BKR7EIX	2667					.032
		GAS, Turbo, Eng Desg CCTA	<b>PFR7S8EG</b>	<b>1675</b>	FR7BHX-S	92400	BKR7EIX	2667					.032
		GAS, Turbo, Eng Desg CPLA	<b>PLFER7A8EG</b>	<b>94833</b>	LFER7BHX	95125							
	L5 2.5L		ZFR6T-11G	5960									.044
2012	L4 2.0L	GAS, Naturally Aspirated, Eng Desg CBPA	ZFR6T-11G	5960									.044
		GAS, Turbo, Eng Desg CBFA	<b>PFR7S8EG</b>	<b>1675</b>	FR7BHX-S	92400	BKR7EIX	2667					.032
		GAS, Turbo, Eng Desg CCTA	<b>PFR7S8EG</b>	<b>1675</b>	FR7BHX-S	92400	BKR7EIX	2667					.032
	L5 2.5L		ZFR6T-11G	5960									.044
2011	L4 2.0L	GAS, Naturally Aspirated, Eng Desg CBPA	ZFR6T-11G	5960									.044
	L5 2.5L		ZFR6T-11G	5960									.044
2010	L4 2.0L	GAS	PFR7S8EG	1675	FR7BHX-S	92400	BKR7EIX	2667					.032
	L5 2.5L		ZFR6T-11G	5960									.044
2009	L4 2.0L	GAS, Turbo	PFR7S8EG	1675	FR7BHX-S	92400	BKR7EIX	2667					.032
	L5 2.5L		ZFR6T-11G	5960									.044
2008	L4 2.0L	Turbo	PFR7S8EG	1675	FR7BHX-S	92400	BKR7EIX	2667					.032
	L5 2.5L		ZFR6T-11G	5960									.044
2007	L4 2.0L	Turbo	PFR7S8EG	1675	FR7BHX-S	92400	BKR7EIX	2667					.032
	L5 2.5L	From Chassis # 1K-7-119 727	ZFR6T-11G	5960									.044
		To Chassis # 1K-7-119 726	<b>PZFR5Q-11</b>	<b>6737</b>			ZFR5AIX-11	94553	ZFR5BGP	90804			.044
2006	L4 1.9L	DIESEL	<b>CZ104</b>	<b>9810</b>									
	L4 2.0L		PFR7S8EG	1675	FR7BHX-S	92400	BKR7EIX	2667					.032
	L5 2.5L		<b>PZFR5Q-11</b>	<b>6737</b>			ZFR5AIX-11	94553	ZFR5BGP	90804			.044
2005	L4 1.8L		<b>PFR6Q</b>	<b>6458</b>			BKR6EIX	6418					.032
	L4 1.9L	DIESEL	<b>CZ104</b>	<b>9810</b>									
	L4 2.0L		<b>PZFR5D-11</b>	<b>7968</b>			ZFR5AIX-11	94553	ZFR5BGP	90804			.044
	L5 2.5L		<b>PZFR5Q-11</b>	<b>6737</b>			ZFR5AIX-11	94553	ZFR5BGP	90804			.044
2004	L4 1.8L		<b>PFR6Q</b>	<b>6458</b>			BKR6EIX	6418					.032
	L4 1.9L	DIESEL, Eng Desg ALH	Y-732J	5909									
		DIESEL, Eng Desg BEW	<b>CZ104</b>	<b>9810</b>									
	L4 2.0L		<b>PZFR5D-11</b>	<b>7968</b>			ZFR5AIX-11	94553	ZFR5BGP	90804			.044
	V6 2.8L		<b>PZFR5D-11</b>	<b>7968</b>			ZFR5AIX-11	94553	ZFR5BGP	90804			.044
2003	L4 1.8L		<b>PFR6Q</b>	<b>6458</b>			BKR6EIX	6418					.032
	L4 1.9L	DIESEL	Y-732J	5909									
	L4 2.0L		<b>PZFR5D-11</b>	<b>7968</b>			ZFR5AIX-11	94553	ZFR5BGP	90804			.044
	V6 2.8L		<b>PZFR5D-11</b>	<b>7968</b>			ZFR5AIX-11	94553	ZFR5BGP	90804			.044
2002	L4 1.8L		<b>PFR6Q</b>	<b>6458</b>			BKR6EIX	6418					.032
	L4 1.9L	DIESEL	Y-732J	5909									
	L4 2.0L		<b>PZFR5D-11</b>	<b>7968</b>			ZFR5AIX-11	94553	ZFR5BGP	90804			.044
	V6 2.8L	DOHC, Eng Desg BDF	<b>PZFR5D-11</b>	<b>7968</b>			ZFR5AIX-11	94553	ZFR5BGP	90804			
SOHC, Eng Desg AFP		<b>BKR5EKUP</b>	<b>2890</b>	FR5BHX	96457	BKR5EIX	6341	BKR5EGP	7090	BKR5E	7938		.028
2001	L4 1.8L		<b>PFR6Q</b>	<b>6458</b>			BKR6EIX	6418					.032
	L4 1.9L	DIESEL	Y-732J	5909									
	L4 2.0L	Eng Desg AEG	<b>BKUR6ET-10</b>	<b>2397</b>	FR6BHX-S	95159	BKR6EIX	6418	BKR6EGP	7092	BKR6E	6962	
Eng Desg AVH		<b>PZFR5D-11</b>	<b>7968</b>			ZFR5AIX-11	94553	ZFR5BGP	90804				.044

**Bold denotes NGK OE Manufacturer and/or OE Service Part**  
NOT BOLD denotes OE Equivalent Part

**Le texte en gras désigne une pièce d'équipement originale du manufacturier NGK et/ou pièce d'équipement originale de service**  
Le texte non en gras désigne une pièce d'équipement originale équivalente

Note: Due to different operating or engine conditions, alternate heat range plugs may be required.

Note: En raison de différences au niveau du fonctionnement ou des conditions du moteur, d'autres types de bougies avec variation de chaleur peuvent être nécessaires



Year	Cyl. L	Notes	Original Equipment		Ruthenium HX		Iridium IX		G-Power		V-Power		Gap
			Part	Stock	Part	Stock	Part	Stock	Part	Stock	Part	Stock	
<b>VOLKSWAGEN (Cont'd)</b>													
<b>Jetta (Cont'd)</b>													
2001		Eng Desg AZG	<b>PZFR5D-11</b>	<b>7968</b>			ZFR5AIX-11	94553	ZFR5BGP	90804			.044
	V6 2.8L		<b>BKR5EKUP</b>	<b>2890</b>	FR5BHX	96457	BKR5EIX	6341	BKR5EGP	7090	BKR5E	7938	.028
2000	L4 1.8L		<b>PFR6Q</b>	<b>6458</b>			BKR6EIX	6418					.032
	L4 1.9L	DIESEL	Y-732J	5909									
	L4 2.0L		<b>BKUR6ET-10</b>	<b>2397</b>	FR6BHX-S	95159							.040
	V6 2.8L		<b>BKR5EKUP</b>	<b>2890</b>	FR5BHX	96457	BKR5EIX	6341	BKR5EGP	7090	BKR5E	7938	.028
1999	L4 1.9L	DIESEL	Y-732J	5909									
	L4 2.0L	Eng Desg ABA	BKR5ES	2460	FR5AHX	95839	BKR5EIX	6341	BKR5EGP	7090	BKR5E	7938	.028
		Eng Desg AEG	<b>BKUR6ET-10</b>	<b>2397</b>	FR6BHX-S	95159							.040
	V6 2.8L		<b>BKR5EKUP</b>	<b>2890</b>	FR5BHX	96457	BKR5EIX	6341	BKR5EGP	7090	BKR5E	7938	.028
1998-97	L4 1.9L	DIESEL	Y-732J	5909									
	L4 2.0L		BKR5E	7938	FR5AHX	95839	BKR5EIX	6341	BKR5EGP	7090	BKR5E	7938	.028
	V6 2.8L		<b>BKR5EKUP</b>	<b>2890</b>	FR5BHX	96457	BKR5EIX	6341	BKR5EGP	7090	BKR5E	7938	.028
1996	L4 1.9L	DIESEL, Turbo	Y-732J	5909									
	L4 2.0L		BKR5E	7938			BKR5EIX	6341	BKR5EGP	7090	BKR5E	7938	.028
	V6 2.8L		<b>BKR5EKUP</b>	<b>2890</b>			BKR5EIX	6341	BKR5EGP	7090	BKR5E	7938	.028
1995	L4 1.8L		<b>BUR6ET</b>	<b>7517</b>									.032
	L4 1.9L	DIESEL, Turbo	Y-732J	5909									
	L4 2.0L		BKR5E	7938			BKR5EIX	6341	BKR5EGP	7090	BKR5E	7938	.028
	V6 2.8L		<b>BKR5EKUP</b>	<b>2890</b>			BKR5EIX	6341	BKR5EGP	7090	BKR5E	7938	.028
1994	L4 1.8L		<b>BUR6ET</b>	<b>7517</b>									.032
	L4 1.9L	DIESEL	Y-918J	3704									
	L4 2.0L		BKR5E	7938			BKR5EIX	6341	BKR5EGP	7090	BKR5E	7938	.028
	V6 2.8L		<b>BKR5EKUP</b>	<b>2890</b>			BKR5EIX	6341	BKR5EGP	7090	BKR5E	7938	.028
1993	L4 1.8L		<b>BUR6ET</b>	<b>7517</b>									.032
	L4 1.9L	DIESEL	Y-918J	3704									
	L4 2.0L		BKR5E	7938			BKR5EIX	6341	BKR5EGP	7090	BKR5E	7938	.028
1992	L4 1.6L	DIESEL	Y-918J	3704									
	L4 1.8L		BP6ET	1263									.032
	L4 2.0L		BKR6E	6962			BKR6EIX	6418	BKR6EGP	7092	BKR6E	6962	.028
1991	L4 1.6L	DIESEL	Y-918J	3704									
	L4 1.8L		<b>BP6ET</b>	<b>1263</b>									.032
	L4 2.0L		BKR6E	6962			BKR6EIX	6418	BKR6EGP	7092	BKR6E	6962	.028
1990	L4 1.6L	DIESEL	Y-918J	3704									
	L4 1.8L		BP6ET	1263									.032
	L4 2.0L		BKR6E	6962			BKR6EIX	6418	BKR6EGP	7092	BKR6E	6962	.028
1989	L4 1.6L	DIESEL	Y-918J	3704									
	L4 1.8L	Eng Desg PF	BP6ET	1263									.032
		Eng Desg PL	<b>BKUR7ET</b>	<b>5496</b>									.032
		Eng Desg RV	BP6ET	1263									.032
1988	L4 1.6L	DIESEL	Y-918J	3704									
	L4 1.8L	Eng Desg PF	BP6ET	1263									.032
		Eng Desg PL	<b>BKUR7ET</b>	<b>5496</b>									.032
		Eng Desg RD	BP6ET	1263									.032
		Eng Desg RV	BP6ET	1263									.032
1987	L4 1.6L	DIESEL	Y-918J	3704									
	L4 1.8L	Eng Desg GX	BP6ET	1263									.032
		Eng Desg PF	BP6ET	1263									.032
		Eng Desg PL	<b>BKUR7ET</b>	<b>5496</b>									.032
		Eng Desg RD	BP6ET	1263									.032
1986-85	L4 1.6L	DIESEL	Y-918J	3704									
	L4 1.8L		BP6ET	1263									.032
<b>Jetta City</b>													
2009	L4 2.0L	GAS, Naturally Aspirated	<b>PZFR5D-11</b>	<b>7968</b>			ZFR5AIX-11	94553	ZFR5BGP	90804			.044
2008-07	L4 2.0L		<b>PZFR5D-11</b>	<b>7968</b>			ZFR5AIX-11	94553	ZFR5BGP	90804			.044



Year	Cyl. L	Notes	Original Equipment		Ruthenium HX		Iridium IX		G-Power		V-Power		Gap
			Part	Stock	Part	Stock	Part	Stock	Part	Stock	Part	Stock	
<b>VOLKSWAGEN (Cont'd)</b>													
<b>Passat</b>													
2017-15	L4 1.8L		<b>PLFER7A8EG</b>	<b>94833</b>	LFER7BHX	95125							.032
	V6 3.6L		<b>ILZKR7A</b>	<b>1961</b>									.036
2014	L4 1.8L		<b>PLFER7A8EG</b>	<b>94833</b>	LFER7BHX	95125							.032
	L5 2.5L		ZFR6T-11G	5960									.044
	V6 3.6L		<b>ILZKR7A</b>	<b>1961</b>									.036
2013-12	L5 2.5L		ZFR6T-11G	5960									.044
	V6 3.6L		<b>ILZKR7A</b>	<b>1961</b>									.036
2010-09	L4 2.0L		<b>PFR7S8EG</b>	<b>1675</b>	FR7BHX-S	92400	BKR7EIX	2667					.032
	V6 3.6L		<b>ILZKR7A</b>	<b>1961</b>									.036
2008-06	L4 2.0L		PFR7S8EG	1675	FR7BHX-S	92400	BKR7EIX	2667					.032
	V6 3.6L		<b>ILZKR7A</b>	<b>1961</b>									.036
2005	L4 1.8L		<b>PFR6Q</b>	<b>6458</b>			BKR6EIX	6418					.032
	V6 2.8L		<b>BKR6EKUB</b>	<b>7969</b>	FR6BHX-S	95159	BKR6EIX	6418	BKR6EGP	7092	BKR6E	6962	.032
2004-02	L4 1.8L		<b>PFR6Q</b>	<b>6458</b>			BKR6EIX	6418					.032
	V6 2.8L		<b>BKR6EKUB</b>	<b>7969</b>	FR6BHX-S	95159	BKR6EIX	6418	BKR6EGP	7092	BKR6E	6962	.032
	W8 4.0L		<b>BKR6EKUE</b>	<b>6292</b>	FR6BHX-S	95159	BKR6EIX	6418	BKR6EGP	7092	BKR6E	6962	.032
2001	L4 1.8L		<b>PFR6Q</b>	<b>6458</b>			BKR6EIX	6418					.032
	V6 2.8L		<b>BKR6EKUB</b>	<b>7969</b>	FR6BHX-S	95159	BKR6EIX	6418	BKR6EGP	7092	BKR6E	6962	.032
2000	L4 1.8L		<b>BKUR6ET</b>	<b>7808</b>	FR6BHX-S	95159	BKR6EIX	6418			BKR6E	6962	.032
	V6 2.8L		<b>BKR6EKUB</b>	<b>7969</b>	FR6BHX-S	95159	BKR6EIX	6418	BKR6EGP	7092	BKR6E	6962	.032
1999	L4 1.8L		PFR6Q	6458			BKR6EIX	6418					.032
	V6 2.8L		<b>BKR6EKUB</b>	<b>7969</b>	FR6BHX-S	95159	BKR6EIX	6418	BKR6EGP	7092	BKR6E	6962	.032
1998	L4 1.8L		<b>BKUR6ET</b>	<b>7808</b>	FR6BHX-S	95159	BKR6EIX	6418			BKR6E	6962	.032
	V6 2.8L		<b>BKR6EKUB</b>	<b>7969</b>	FR6BHX-S	95159	BKR6EIX	6418	BKR6EGP	7092	BKR6E	6962	.032
1997	L4 1.9L	DIESEL, Eng Desg AAZ	Y-918J	3704									
		DIESEL, Eng Desg AHU	Y-732J	5909									
	V6 2.8L		<b>BKR5EKU</b>	<b>3964</b>	FR5BHX	96457	BKR5EIX	6341	BKR5EGP	7090	BKR5E	7938	.028
1996	L4 1.9L	DIESEL, Eng Desg 1Z	Y-732J	5909									
		DIESEL, Eng Desg AAZ	Y-918J	3704									
	L4 2.0L		BKR5E	7938			BKR5EIX	6341	BKR5EGP	7090	BKR5E	7938	.028
	V6 2.8L		<b>BKR5EKU</b>	<b>3964</b>			BKR5EIX	6341	BKR5EGP	7090	BKR5E	7938	.028
1995	L4 1.9L	DIESEL	Y-918J	3704									
	L4 2.0L		BKR5E	7938			BKR5EIX	6341	BKR5EGP	7090	BKR5E	7938	.028
	V6 2.8L		<b>BKR5EKU</b>	<b>3964</b>			BKR5EIX	6341	BKR5EGP	7090	BKR5E	7938	.028
1994	L4 1.9L	DIESEL	Y-918J	3704									
	L4 2.0L		<b>BKUR7ET</b>	<b>5496</b>									.032
	V6 2.8L		<b>BKR5EKU</b>	<b>3964</b>			BKR5EIX	6341	BKR5EGP	7090	BKR5E	7938	.028
1993	L4 1.8L		BP6ET	1263			BPR6EIX	6637	BPR6EGP	7084			.032
	L4 1.9L	DIESEL	Y-918J	3704									
	L4 2.0L		<b>BKUR7ET</b>	<b>5496</b>									.032
	V6 2.8L		<b>BKR5EKU</b>	<b>3964</b>			BKR5EIX	6341	BKR5EGP	7090	BKR5E	7938	.028
1992	L4 1.8L		BP6ET	1263									.032
	L4 2.0L		<b>BKUR7ET</b>	<b>5496</b>									.032
1991	L4 1.8L		BP6ET	1263			BPR6EIX	6637	BPR6EGP	7084			.032
	L4 2.0L		BKR6E	6962			BKR6EIX	6418	BKR6EGP	7092	BKR6E	6962	.028
1990	L4 2.0L		BKR6E	6962			BKR6EIX	6418	BKR6EGP	7092	BKR6E	6962	.028
<b>Passat CC</b>													
2010-09	L4 2.0L		<b>PFR7S8EG</b>	<b>1675</b>	FR7BHX-S	92400	BKR7EIX	2667					.032
	V6 3.6L		<b>ILZKR7A</b>	<b>1961</b>									.036
<b>Phaeton</b>													
2006	V8 4.2L		<b>BKR6EQUA</b>	<b>5767</b>	FR6AHX-S	94279	BKR6EIX	6418	BKR6EGP	7092	BKR6E	6962	.032
	W12 6.0L		<b>PZFR5J-11</b>	<b>7743</b>			ZFR5AIX-11	94553	ZFR5BGP	90804			.044
2005-04	V8 4.2L		<b>BKR6EQUA</b>	<b>5767</b>	FR6AHX-S	94279	BKR6EIX	6418	BKR6EGP	7092	BKR6E	6962	.032

**Bold denotes NGK OE Manufacturer and/or OE Service Part**  
NOT BOLD denotes OE Equivalent Part

**Le texte en gras désigne une pièce d'équipement originale du manufacturier NGK et/ou pièce d'équipement originale de service**  
Le texte non en gras désigne une pièce d'équipement originale équivalente

Note: Due to different operating or engine conditions, alternate heat range plugs may be required.

Note: En raison de différences au niveau du fonctionnement ou des conditions du moteur, d'autres types de bougies avec variation de chaleur peuvent être nécessaires





Year	Cyl. L	Notes	Original Equipment		Ruthenium HX		Iridium IX		G-Power		V-Power		Gap
			Part	Stock	Part	Stock	Part	Stock	Part	Stock	Part	Stock	
<b>VOLKSWAGEN (Cont'd)</b>													
<b>Phaeton (Cont'd)</b>													
2005-04	W12 6.0L		<b>PZFR6J-11</b>	<b>3586</b>									.044
<b>Quantum</b>													
1988	L5 2.2L		BP6ET	1263									.032
1987-86	L5 2.2L	Eng Desg JT	BPR6ES	7131			BPR6EIX	6637	BPR6EGP	7084	BPR6EY	6427	.032
		Eng Desg KX	BP6ET	1263									.032
1985	L4 1.6L	DIESEL	Y-918J	3704									
	L4 1.8L		BPR6ES	7131			BPR6EIX	6637	BPR6EGP	7084	BPR6EY	6427	.028
	L5 2.2L		BP6ET	1263									.032
<b>R32</b>													
2008	V6 3.2L		<b>IZKR7B</b>	<b>7563</b>									.036
<b>Rabbit</b>													
2009-06	L5 2.5L		<b>PZFR5Q-11</b>	<b>6737</b>			ZFR5AIX-11	94553	ZFR5BGP	90804			.044
<b>Routan</b>													
2014-11	V6 3.6L		SILZKR7B11	9723	LKR7BHX	94705	LKR7DIX-11S	93175	LKR7BGP-S	97390			.044
2010-09	V6 3.8L		PLZTR5A-13	4998			LZTR5AIX-13	2314	LZTR5AGP	3381	LZTR5A-13	4306	.050
	V6 4.0L		<b>ZFR5LP-13G</b>	<b>7781</b>			ZFR5FIX-11E	96807	ZFR5FGP-E	94407			.052
<b>Scirocco</b>													
1989	L4 1.8L		BP6ET	1263									.032
1988-86	L4 1.8L	Eng Desg JH	BP6ET	1263									.032
		Eng Desg PL	<b>BKUR7ET</b>	<b>5496</b>									.032
1985	L4 1.8L		BP6ET	1263									.032
<b>Tiguan</b>													
2017-09	L4 2.0L		<b>PFR7S8EG</b>	<b>1675</b>	FR7BHX-S	92400	BKR7EIX	2667					.032
<b>Touareg</b>													
2017-16	V6 3.6L		<b>ILZKR7A</b>	<b>1961</b>									.036
2015-11	V6 3.0L	ELECTRIC/GAS	<b>PFR8S8EG</b>	<b>94460</b>									.032
	V6 3.6L		<b>ILZKR7A</b>	<b>1961</b>									.036
2010	V6 3.6L		<b>ILZKR7A</b>	<b>1961</b>									.036
2009	V6 3.6L		<b>ILZKR7A</b>	<b>1961</b>									.036
	V8 4.2L		<b>PFR6W-TG</b>	<b>5547</b>									.036
2008	V6 3.6L		<b>ILZKR7A</b>	<b>1961</b>									.036
	V8 4.2L		<b>PFR6W-TG</b>	<b>5547</b>									.036
	V10 5.0L	DIESEL	<b>CZ104</b>	<b>9810</b>									
2007	V6 3.6L		<b>ILZKR7A</b>	<b>1961</b>									.036
	V8 4.2L	Eng Desg AXQ	<b>BKR6EQUA</b>	<b>5767</b>	FR6AHX-S	94279	BKR6EIX	6418	BKR6EGP	7092	BKR6E	6962	.032
		Eng Desg BAR	<b>PFR6W-TG</b>	<b>5547</b>									.036
2006	V10 5.0L	DIESEL	<b>CZ104</b>	<b>9810</b>									
	V6 3.2L		<b>IZKR7B</b>	<b>7563</b>									.036
	V8 4.2L		<b>BKR6EQUA</b>	<b>5767</b>	FR6AHX-S	94279	BKR6EIX	6418	BKR6EGP	7092	BKR6E	6962	.032
2005-04	V10 5.0L	DIESEL	<b>CZ104</b>	<b>9810</b>									
	V6 3.2L		<b>IZKR7B</b>	<b>7563</b>									.036
	V8 4.2L		<b>BKR6EQUA</b>	<b>5767</b>	FR6AHX-S	94279	BKR6EIX	6418	BKR6EGP	7092	BKR6E	6962	.032
<b>Transporter</b>													
1994	L5 2.4L	DIESEL	Y-918J	3704									
1993	L5 2.4L	DIESEL	Y-918J	3704									
	L5 2.5L		BPR5EKU	5685									.032
1992	L5 2.5L		BPR5EKU	5685									.032
1991-86	H4 2.1L		BR6ES	4922									.028
1985	H4 1.9L		BR6ES	4922									.028
<b>Vanagon</b>													
1991-86	H4 2.1L		BR6ES	4922									.028
1985	H4 1.9L		BR6ES	4922									.028
<b>VOLVO</b>													
<b>240</b>													
1993-90	L4 2.3L		BPR6ES	7131			BPR6EIX	6637	BPR6EGP	7084	BPR6EY	6427	.028



Year	Cyl. L	Notes	Original Equipment		Ruthenium HX		Iridium IX		G-Power		V-Power		Gap
			Part	Stock	Part	Stock	Part	Stock	Part	Stock	Part	Stock	
<b>VOLVO (Cont'd)</b>													
<b>244</b>													
1989-86	L4 2.3L		BPR6ES	7131			BPR6EIX	6637	BPR6EGP	7084	BPR6EY	6427	.028
1985	L4 2.1L		BPR6ES	7131			BPR6EIX	6637	BPR6EGP	7084	BPR6EY	6427	.028
	L4 2.3L		BPR6ES	7131			BPR6EIX	6637	BPR6EGP	7084	BPR6EY	6427	.028
<b>245</b>													
1989-86	L4 2.3L		BPR6ES	7131			BPR6EIX	6637	BPR6EGP	7084	BPR6EY	6427	.028
1985	L4 2.1L		BPR6ES	7131			BPR6EIX	6637	BPR6EGP	7084	BPR6EY	6427	.028
	L4 2.3L		BPR6ES	7131			BPR6EIX	6637	BPR6EGP	7084	BPR6EY	6427	.028
<b>740</b>													
1992-87	L4 2.3L		BPR6ES	7131			BPR6EIX	6637	BPR6EGP	7084	BPR6EY	6427	.028
1986	L4 2.3L		BPR6ES	7131			BPR6EIX	6637	BPR6EGP	7084	BPR6EY	6427	.028
	L6 2.4L	DIESEL	Y-918J	3704									
1985	L4 2.3L		BPR6ES	7131			BPR6EIX	6637	BPR6EGP	7084	BPR6EY	6427	.028
<b>745</b>													
1985	L4 2.3L		BPR6ES	7131			BPR6EIX	6637	BPR6EGP	7084	BPR6EY	6427	.028
	L6 2.4L	DIESEL	Y-918J	3704									
<b>760</b>													
1990-86	L4 2.3L		BPR6ES	7131			BPR6EIX	6637	BPR6EGP	7084	BPR6EY	6427	.028
	V6 2.8L		TR5	2238			TR5IX	7397	TR5GP	3186	TR5	2238	.030
1985	L4 2.3L		BPR6ES	7131			BPR6EIX	6637	BPR6EGP	7084	BPR6EY	6427	.028
	L6 2.4L	DIESEL	Y-918J	3704									
	V6 2.8L		TR5	2238			TR5IX	7397	TR5GP	3186	TR5	2238	.030
<b>780</b>													
1991	L4 2.3L		BPR6ES	7131			BPR6EIX	6637	BPR6EGP	7084	BPR6EY	6427	.028
1990-89	L4 2.3L		BPR6ES	7131			BPR6EIX	6637	BPR6EGP	7084	BPR6EY	6427	.028
	V6 2.8L		TR5	2238			TR5IX	7397	TR5GP	3186	TR5	2238	.030
1988-87	V6 2.8L		TR5	2238			TR5IX	7397	TR5GP	3186	TR5	2238	.030
<b>850</b>													
1997	L5 2.3L		PFR6B	3500	FR6BHX-S	95159	BKR6EIX	6418	BKR6EGP	7092	BKR6E	6962	.028
	L5 2.4L	Naturally Aspirated	BKR6EQUA	5767	FR6BHX-S	95159	BKR6EIX	6418	BKR6EGP	7092	BKR6E	6962	.028
		Turbo	PFR6B	3500	FR6BHX-S	95159	BKR6EIX	6418	BKR6EGP	7092	BKR6E	6962	.028
1996-94	L5 2.3L		PFR6B	3500			BKR6EIX	6418	BKR6EGP	7092	BKR6E	6962	.028
	L5 2.4L		BKR6EQUA	5767			BKR6EIX	6418	BKR6EGP	7092	BKR6E	6962	.028
1993	L5 2.4L		BKR6EQUA	5767			BKR6EIX	6418	BKR6EGP	7092	BKR6E	6962	.028
<b>940</b>													
1995-91	L4 2.3L		BPR6ES	7131			BPR6EIX	6637	BPR6EGP	7084	BPR6EY	6427	.028
<b>960</b>													
1997	L6 2.9L		BKR6EQUA	5767	FR6AHX-S	94279	BKR6EIX	6418	BKR6EGP	7092	BKR6E	6962	.028
1996-95	L6 2.9L		BKR6EQUA	5767			BKR6EIX	6418	BKR6EGP	7092	BKR6E	6962	.028
1994-92	L6 2.9L		BKR6E	6962			BKR6EIX	6418	BKR6EGP	7092	BKR6E	6962	.028
<b>C30</b>													
2013-11	L5 2.5L		ILFR6B	6481	LFR6BHX	93420	LFR6AIX	93893	LFR6CGP	1483			.028
2010-07	L5 2.4L		<b>LFR6D</b>	<b>6490</b>			LFR6AIX-11	6619	LFR6CGP	1483			.028
	L5 2.5L		ILFR6B	6481	LFR6BHX	93420	LFR6AIX	93893	LFR6CGP	1483			.028
<b>C70</b>													
2013-06	L5 2.5L		ILFR6B	6481	LFR6BHX	93420	LFR6AIX	93893	LFR6CGP	1483			.028
2004-98	L5 2.3L		PFR6B	3500	FR6BHX-S	95159	BKR6EIX	6418	BKR6EGP	7092	BKR6E	6962	.028
	L5 2.4L		PFR6B	3500	FR6BHX-S	95159	BKR6EIX	6418	BKR6EGP	7092	BKR6E	6962	.028
<b>S40</b>													
2011	L5 2.5L		ILFR6B	6481	LFR6BHX	93420	LFR6AIX	93893	LFR6CGP	1483			.028
2010-05	L5 2.4L		<b>LFR6D</b>	<b>6490</b>			LFR6AIX-11	6619	LFR6CGP	1483			.028
	L5 2.5L		ILFR6B	6481	LFR6BHX	93420	LFR6AIX	93893	LFR6CGP	1483			.028
2004	L4 1.9L		PFR6B	3500	FR6BHX-S	95159	BKR6EIX	6418	BKR6EGP	7092	BKR6E	6962	.028
	L5 2.4L		<b>LFR6D</b>	<b>6490</b>			LFR6AIX-11	6619	LFR6CGP	1483			.028
	L5 2.5L		ILFR6B	6481	LFR6BHX	93420	LFR6AIX	93893	LFR6CGP	1483			.028
2003-00	L4 1.9L		PFR6B	3500	FR6BHX-S	95159	BKR6EIX	6418	BKR6EGP	7092	BKR6E	6962	.028
<b>S60</b>													
2016-13	L6 3.0L		DILFR6J11	92491	LFR6BHX	93420	LFR6AIX-11	6619	LFR6CGP	1483			.040

**Bold denotes NGK OE Manufacturer and/or OE Service Part**  
NOT BOLD denotes OE Equivalent Part

**Le texte en gras désigne une pièce d'équipement originale du manufacturier NGK et/ou pièce d'équipement originale de service**  
Le texte non en gras désigne une pièce d'équipement originale équivalente

Note: Due to different operating or engine conditions, alternate heat range plugs may be required.

Note: En raison de différences au niveau du fonctionnement ou des conditions du moteur, d'autres types de bougies avec variation de chaleur peuvent être nécessaires



Year	Cyl. L	Notes	Original Equipment		Ruthenium HX		Iridium IX		G-Power		V-Power		Gap
			Part	Stock	Part	Stock	Part	Stock	Part	Stock	Part	Stock	
<b>VOLVO (Cont'd)</b>													
<b>S60 (Cont'd)</b>													
2012	L5 2.5L		DILFR6J11	92491	LFR6BHX	93420	LFR6AIX-11	6619	LFR6CGP	1483			.040
	L6 3.0L		ILFR6B	6481	LFR6BHX	93420	LFR6AIX	93893	LFR6CGP	1483			.028
2011	L6 3.0L		ILFR6B	6481	LFR6BHX	93420	LFR6AIX	93893	LFR6CGP	1483			.028
2009-08	L5 2.4L		ILFR6B	6481	LFR6BHX	93420	LFR6AIX	93893	LFR6CGP	1483			.028
	L5 2.5L		PFR6B	3500	FR6BHX-S	95159	BKR6EIX	6418	BKR6EGP	7092	BKR6E	6962	.028
2007-06	L5 2.4L		ILFR6B	6481	LFR6BHX	93420	LFR6AIX	93893	LFR6CGP	1483			.028
	L5 2.5L	Eng Desg B5254T2	PFR6B	3500	FR6BHX-S	95159	BKR6EIX	6418	BKR6EGP	7092	BKR6E	6962	.028
		Eng Desg B5254T4	ILFR6B	6481	LFR6BHX	93420	LFR6AIX	93893	LFR6CGP	1483			.028
2005	L5 2.4L	Naturally Aspirated	BKR6EQUA	5767	FR6BHX-S	95159	BKR6EIX	6418	BKR6EGP	7092	BKR6E	6962	.028
		Turbo	ILFR6B	6481	LFR6BHX	93420	LFR6AIX	93893	LFR6CGP	1483			.028
	L5 2.5L	Eng Desg B5254T2	PFR6B	3500	FR6BHX-S	95159	BKR6EIX	6418	BKR6EGP	7092	BKR6E	6962	.028
		Eng Desg B5254T4	ILFR6B	6481	LFR6BHX	93420	LFR6AIX	93893	LFR6CGP	1483			.028
2004	L5 2.3L		PFR6B	3500	FR6BHX-S	95159	BKR6EIX	6418	BKR6EGP	7092	BKR6E	6962	.028
	L5 2.4L	Naturally Aspirated	BKR6EQUA	5767	FR6AHX-S	94279	BKR6EIX	6418	BKR6EGP	7092	BKR6E	6962	.028
	L5 2.5L	Eng Desg B5254T2	PFR6B	3500	FR6BHX-S	95159	BKR6EIX	6418	BKR6EGP	7092	BKR6E	6962	.028
		Eng Desg B5254T4	ILFR6B	6481	LFR6BHX	93420	LFR6AIX	93893	LFR6CGP	1483			.028
2003	L5 2.3L		PFR6B	3500	FR6BHX-S	95159	BKR6EIX	6418	BKR6EGP	7092	BKR6E	6962	.028
	L5 2.4L	Naturally Aspirated	BKR6EQUA	5767	FR6BHX-S	95159	BKR6EIX	6418	BKR6EGP	7092	BKR6E	6962	.028
		Turbo	PFR6B	3500	FR6BHX-S	95159	BKR6EIX	6418	BKR6EGP	7092	BKR6E	6962	.028
2002	L5 2.5L		PFR6B	3500	FR6BHX-S	95159	BKR6EIX	6418	BKR6EGP	7092	BKR6E	6962	.028
	L5 2.3L		PFR6B	3500	FR6BHX-S	95159	BKR6EIX	6418	BKR6EGP	7092	BKR6E	6962	.028
2001	L5 2.4L	Naturally Aspirated	BKR6EQUA	5767	FR6BHX-S	95159	BKR6EIX	6418	BKR6EGP	7092	BKR6E	6962	.030
		Turbo	PFR6B	3500	FR6BHX-S	95159	BKR6EIX	6418	BKR6EGP	7092	BKR6E	6962	.028
	L5 2.3L		PFR6B	3500	FR6BHX-S	95159	BKR6EIX	6418	BKR6EGP	7092	BKR6E	6962	.028
<b>S70</b>													
2000-98	L5 2.3L		PFR6B	3500	FR6BHX-S	95159	BKR6EIX	6418	BKR6EGP	7092	BKR6E	6962	.028
	L5 2.4L	Naturally Aspirated	BKR6EQUA	5767	FR6BHX-S	95159	BKR6EIX	6418	BKR6EGP	7092	BKR6E	6962	.028
		Turbo	PFR6B	3500	FR6BHX-S	95159	BKR6EIX	6418	BKR6EGP	7092	BKR6E	6962	.028
<b>S80</b>													
2015	L6 3.0L		DILFR6J11	92491	LFR6BHX	93420	LFR6AIX-11	6619	LFR6CGP	1483			.040
2014-12	L6 3.0L		DILFR6J11	92491	LFR6BHX	93420	LFR6AIX-11	6619	LFR6CGP	1483			.040
	L6 3.2L		DILFR6J11	92491	LFR6AHX-S	94122	LFR6AIX-11	6619	LFR6CGP	1483			.040
2011	L6 3.0L		ILFR6B	6481	LFR6BHX	93420	LFR6AIX	93893	LFR6CGP	1483			.028
	L6 3.2L		<b>ILFR6B</b>	<b>6481</b>	LFR6BHX	93420	LFR6AIX	93893	LFR6CGP	1483			.028
2010-08	L6 3.0L		ILFR6B	6481	LFR6BHX	93420	LFR6AIX	93893	LFR6CGP	1483			.028
	L6 3.2L		<b>ILFR6B</b>	<b>6481</b>	LFR6BHX	93420	LFR6AIX	93893	LFR6CGP	1483			.028
	V8 4.4L		<b>IFR6B11</b>	<b>5368</b>	FR6AHX-S	94279	BKR6EIX-11	3764	BKR6EGP	7092	BKR6E	6962	.044
2007	L6 3.2L		<b>ILFR6B</b>	<b>6481</b>	LFR6BHX	93420	LFR6AIX	93893	LFR6CGP	1483			.028
	V8 4.4L		<b>IFR6B11</b>	<b>5368</b>	FR6AHX-S	94279	BKR6EIX-11	3764	BKR6EGP	7092	BKR6E	6962	.044
2006	L5 2.5L		PFR6B	3500	FR6BHX-S	95159	BKR6EIX	6418	BKR6EGP	7092	BKR6E	6962	.028
2005	L5 2.5L		PFR6B	3500	FR6BHX-S	95159	BKR6EIX	6418	BKR6EGP	7092	BKR6E	6962	.028
	L6 2.9L		PFR6B	3500	FR6BHX-S	95159	BKR6EIX	6418	BKR6EGP	7092	BKR6E	6962	.028
2004	L5 2.5L		PFR6B	3500	FR6BHX-S	95159	BKR6EIX	6418	BKR6EGP	7092	BKR6E	6962	.028
	L6 2.9L	Naturally Aspirated	BKR6EQUA	5767	FR6BHX-S	95159	BKR6EIX	6418	BKR6EGP	7092	BKR6E	6962	.028
		Turbo	PFR6B	3500	FR6BHX-S	95159	BKR6EIX	6418	BKR6EGP	7092	BKR6E	6962	.028
2003-02	L6 2.9L	Naturally Aspirated	BKR6EQUA	5767	FR6BHX-S	95159	BKR6EIX	6418	BKR6EGP	7092	BKR6E	6962	.028
		Turbo	PFR6B	3500	FR6BHX-S	95159	BKR6EIX	6418	BKR6EGP	7092	BKR6E	6962	.028
2001-99	L6 2.8L		PFR6B	3500	FR6BHX-S	95159	BKR6EIX	6418	BKR6EGP	7092	BKR6E	6962	.028
	L6 2.9L		BKR6EQUA	5767	FR6AHX-S	94279	BKR6EIX	6418	BKR6EGP	7092	BKR6E	6962	.028
<b>S90</b>													
1998-97	L6 2.9L		BKR6EQUA	5767	FR6AHX-S	94279	BKR6EIX	6418	BKR6EGP	7092	BKR6E	6962	.028
<b>V40</b>													
2004-00	L4 1.9L		PFR6B	3500	FR6BHX-S	95159	BKR6EIX	6418	BKR6EGP	7092	BKR6E	6962	.028
<b>V50</b>													
2011	L5 2.5L		ILFR6B	6481	LFR6BHX	93420	LFR6AIX	93893	LFR6CGP	1483			.028



Year	Cyl. L	Notes	Original Equipment		Ruthenium HX		Iridium IX		G-Power		V-Power		Gap
			Part	Stock	Part	Stock	Part	Stock	Part	Stock	Part	Stock	
<b>VOLVO (Cont'd)</b>													
<b>V50 (Cont'd)</b>													
2010-05	L5 2.4L		<b>LFR6D</b>	<b>6490</b>			LFR6AIX-11	6619	LFR6CGP	1483			.028
	L5 2.5L		ILFR6B	6481	LFR6BHX	93420	LFR6AIX	93893	LFR6CGP	1483			.028
<b>V60</b>													
2016-15	L6 3.0L		DILFR6J11	92491	LFR6BHX	93420	LFR6AIX-11	6619	LFR6CGP	1483			.040
<b>V70</b>													
2010-08	L6 3.2L		<b>ILFR6B</b>	<b>6481</b>	LFR6BHX	93420	LFR6AIX	93893	LFR6CGP	1483			.028
2007-06	L5 2.4L		BKR6EQUA	5767	FR6AHX-S	94279	BKR6EIX	6418	BKR6EGP	7092	BKR6E	6962	.028
	L5 2.5L	Eng Desg B5254T2	PFR6B	3500	FR6BHX-S	95159	BKR6EIX	6418	BKR6EGP	7092	BKR6E	6962	.028
		Eng Desg B5254T4	ILFR6B	6481	LFR6BHX	93420	LFR6AIX	93893	LFR6CGP	1483			.028
2005	L5 2.4L	Naturally Aspirated	BKR6EQUA	5767	FR6BHX-S	95159	BKR6EIX	6418	BKR6EGP	7092	BKR6E	6962	.028
		Turbo	ILFR6B	6481	LFR6BHX	93420	LFR6AIX	93893	LFR6CGP	1483			.028
	L5 2.5L	Eng Desg B5254T2	PFR6B	3500	FR6BHX-S	95159	BKR6EIX	6418	BKR6EGP	7092	BKR6E	6962	.028
		Eng Desg B5254T4	ILFR6B	6481	LFR6BHX	93420	LFR6AIX	93893	LFR6CGP	1483			.028
2004	L5 2.3L		PFR6B	3500	FR6BHX-S	95159	BKR6EIX	6418	BKR6EGP	7092	BKR6E	6962	.028
	L5 2.4L		BKR6EQUA	5767	FR6AHX-S	94279	BKR6EIX	6418	BKR6EGP	7092	BKR6E	6962	.028
	L5 2.5L	Eng Desg B5254T2	PFR6B	3500	FR6BHX-S	95159	BKR6EIX	6418	BKR6EGP	7092	BKR6E	6962	.028
		Eng Desg B5254T4	ILFR6B	6481	LFR6BHX	93420	LFR6AIX	93893	LFR6CGP	1483			.028
2003	L5 2.3L		PFR6B	3500	FR6BHX-S	95159	BKR6EIX	6418	BKR6EGP	7092	BKR6E	6962	.028
	L5 2.4L	Naturally Aspirated	BKR6EQUA	5767	FR6BHX-S	95159	BKR6EIX	6418	BKR6EGP	7092	BKR6E	6962	.028
		Turbo	PFR6B	3500	FR6BHX-S	95159	BKR6EIX	6418	BKR6EGP	7092	BKR6E	6962	.028
	L5 2.5L		PFR6B	3500	FR6BHX-S	95159	BKR6EIX	6418	BKR6EGP	7092	BKR6E	6962	.028
2002-98	L5 2.3L		PFR6B	3500	FR6BHX-S	95159	BKR6EIX	6418	BKR6EGP	7092	BKR6E	6962	.028
	L5 2.4L	Naturally Aspirated	BKR6EQUA	5767	FR6BHX-S	95159	BKR6EIX	6418	BKR6EGP	7092	BKR6E	6962	.028
		Turbo	PFR6B	3500	FR6BHX-S	95159	BKR6EIX	6418	BKR6EGP	7092	BKR6E	6962	.028
<b>V90</b>													
1998-97	L6 2.9L		BKR6EQUA	5767	FR6AHX-S	94279	BKR6EIX	6418	BKR6EGP	7092	BKR6E	6962	.028
<b>XC60</b>													
2016	L6 3.0L		DILFR6J11	92491	LFR6BHX	93420	LFR6AIX-11	6619	LFR6CGP	1483			.040
2015-12	L6 3.0L		DILFR6J11	92491	LFR6BHX	93420	LFR6AIX-11	6619	LFR6CGP	1483			.040
	L6 3.2L		DILFR6J11	92491	LFR6AHX-S	94122	LFR6AIX-11	6619	LFR6CGP	1483			.040
2011-10	L6 3.0L		ILFR6B	6481	LFR6BHX	93420	LFR6AIX	93893	LFR6CGP	1483			.028
	L6 3.2L		<b>ILFR6B</b>	<b>6481</b>	LFR6BHX	93420	LFR6AIX	93893	LFR6CGP	1483			.028
<b>XC70</b>													
2015-12	L6 3.0L		DILFR6J11	92491	LFR6BHX	93420	LFR6AIX-11	6619	LFR6CGP	1483			.040
	L6 3.2L		DILFR6J11	92491	LFR6AHX-S	94122	LFR6AIX-11	6619	LFR6CGP	1483			.040
2011-09	L6 3.0L		ILFR6B	6481	LFR6BHX	93420	LFR6AIX	93893	LFR6CGP	1483			.028
	L6 3.2L		<b>ILFR6B</b>	<b>6481</b>	LFR6BHX	93420	LFR6AIX	93893	LFR6CGP	1483			.028
2008	L6 3.2L		<b>ILFR6B</b>	<b>6481</b>	LFR6BHX	93420	LFR6AIX	93893	LFR6CGP	1483			.028
2007-03	L5 2.5L		PFR6B	3500	FR6BHX-S	95159	BKR6EIX	6418	BKR6EGP	7092	BKR6E	6962	.028
<b>XC90</b>													
2014-12	L6 3.2L		DILFR6J11	92491	LFR6AHX-S	94122	LFR6AIX-11	6619	LFR6CGP	1483			.040
2011-07	L6 3.2L		<b>ILFR6B</b>	<b>6481</b>	LFR6BHX	93420	LFR6AIX	93893	LFR6CGP	1483			.028
	V8 4.4L		<b>IFR6B11</b>	<b>5368</b>	FR6AHX-S	94279	BKR6EIX-11	3764	BKR6EGP	7092	BKR6E	6962	.044
2006	L5 2.5L		PFR6B	3500	FR6BHX-S	95159	BKR6EIX	6418	BKR6EGP	7092	BKR6E	6962	.028
	V8 4.4L		<b>IFR6B11</b>	<b>5368</b>	FR6AHX-S	94279	BKR6EIX-11	3764	BKR6EGP	7092	BKR6E	6962	.044
2005	L5 2.5L		PFR6B	3500	FR6BHX-S	95159	BKR6EIX	6418	BKR6EGP	7092	BKR6E	6962	.028
	L6 2.9L		PFR6B	3500	FR6BHX-S	95159	BKR6EIX	6418	BKR6EGP	7092	BKR6E	6962	.028
	V8 4.4L		<b>IFR6B11</b>	<b>5368</b>	FR6AHX-S	94279	BKR6EIX-11	3764	BKR6EGP	7092	BKR6E	6962	.044
2004-03	L5 2.5L		PFR6B	3500	FR6BHX-S	95159	BKR6EIX	6418	BKR6EGP	7092	BKR6E	6962	.028
	L6 2.9L		PFR6B	3500	FR6BHX-S	95159	BKR6EIX	6418	BKR6EGP	7092	BKR6E	6962	.028
<b>YUGO</b>													
<b>Cabrio</b>													
1992-90	L4 1.3L		BPR5ES	7734			BPR5EIX	6597	BPR5EGP	7082	BPR5EY	1233	.030
<b>GV</b>													
1992-90	L4 1.3L		BPR5ES	7734			BPR5EIX	6597	BPR5EGP	7082	BPR5EY	1233	.030
1989-86	L4 1.1L		BPR5ES	7734			BPR5EIX	6597	BPR5EGP	7082	BPR5EY	1233	.030

**Bold denotes NGK OE Manufacturer and/or OE Service Part**  
NOT BOLD denotes OE Equivalent Part

**Le texte en gras désigne une pièce d'équipement originale du manufacturier NGK et/ou pièce d'équipement originale de service**  
Le texte non en gras désigne une pièce d'équipement originale équivalente

Note: Due to different operating or engine conditions, alternate heat range plugs may be required.

Note: En raison de différences au niveau du fonctionnement ou des conditions du moteur, d'autres types de bougies avec variation de chaleur peuvent être nécessaires



Year	Cyl. L	Notes	Original Equipment		Ruthenium HX		Iridium IX		G-Power		V-Power		Gap
			Part	Stock	Part	Stock	Part	Stock	Part	Stock	Part	Stock	
<b>YUGO (Cont'd)</b>													
GVL													
1989-88	L4 1.1L		BPR5ES	7734			BPR5EIX	6597	BPR5EGP	7082	BPR5EY	1233	.030
GVS													
1988	L4 1.1L		BPR5ES	7734			BPR5EIX	6597	BPR5EGP	7082	BPR5EY	1233	.030
GVX													
1989-88	L4 1.3L		BPR5ES	7734			BPR5EIX	6597	BPR5EGP	7082	BPR5EY	1233	.030





*THE IGNITION SPECIALIST™*

# **BUYER'S GUIDE**





127	SIFR6A11	Laser Iridium
Qty per Vehicle: 4		Box Qty: 4
Subaru	Legacy	2012-2010
	Outback	2012-2010
372	ZNAR6AIX-11	Iridium IX
Qty per Vehicle: 8-10		Box Qty: 4
Ford	Expedition	2014-2008
	Explorer	2010-2008
	Explorer Sport Trac	2010-2008
	F53	2009-2008
	F53	2017-2011
	F59	2017-2011
	F650	2013-2012
	F-150	2010-2008
	F-250 Super Duty	2010-2008
	F-350 Super Duty	2010-2008
	F-450 Super Duty	2017-2008
	F-550 Super Duty	2017-2008
	Mustang	2010-2008
Lincoln	Mark LT	2008
	Navigatior	2014-2008
Mercury	Mountaineer	2010-2008
373	SILFR6B8	Laser Iridium
Qty per Vehicle: 4		Box Qty: 4
Subaru	Legacy	2012-2010
1041	ZFR6A-11	V-Power
Qty per Vehicle: 4-6		Box Qty: 4
Mazda	626	1989-1988
	929	1991-1988
	B2600	1989
	MPV	1989
	MX-6	1989-1988
1094	BR7EFS	Standard
Qty per Vehicle: 12		Box Qty: 10
Jaguar	XJ12	1990-1989
	XJS	1990-1989
1095	BCPR7ES-11	Standard
Qty per Vehicle: 4		Box Qty: 4
Saab	9-3	1999
	900	1998-1994
	9000	1998-1989
1208	ILZFR6D11	Laser Iridium
Qty per Vehicle: 6		Box Qty: 4
BMW	323i	2007-2006
	325i	2006
	325xi	2006
	328i	2007
	328xi	2007
	330i	2006
	330xi	2006
	525i	2007-2006
	525xi	2007-2006
	530i	2007-2006
	530xi	2007-2006
	X3	2007
	X5	2007
	Z4	2007-2006
	1209	PTR4G-15
Qty per Vehicle: 6-8		Box Qty: 4
Chevrolet	C1500	1999-1996
	C1500 Suburban	1997-1996
	C2500	1993-1992
	C2500	1999-1996
	C2500 Suburban	1997-1996
	C3500	1997

1209 (Cont'd)	PTR4G-15	Laser Platinum
Qty per Vehicle: 6-8		Box Qty: 4
Chevrolet	Express 1500	2002-1996
	Express 1500	2010-2008
	Express 2500	2002-1996
	Express 3500	1997-1996
	G30	1995
	K1500	1999-1996
	K1500 Suburban	1997-1996
	K2500	1993-1992
	K2500	1998-1996
	K2500 Suburban	1997-1996
	K3500	1997-1996
	P30	1999-1996
	Silverado 1500	2009
	Tahoe	1997-1996
	GMC	C1500
C1500 Suburban		1997-1996
C2500		1999-1996
C2500 Suburban		1997-1996
C3500		1997-1996
K1500		1999-1996
K1500 Suburban		1997-1996
K2500		1998-1996
K2500 Suburban		1997-1996
K3500		1997-1996
P3500		1999-1996
Savana 1500		2002-1996
Savana 1500		2010-2008
Savana 2500		2002-1996
Savana 3500		1997-1996
Yukon	1997-1996	
1233	BPR5EY	V-Power
Qty per Vehicle: 3-12		Box Qty: 4
Aston Martin	Lagonda	1989-1979
	V-8	1989-1979
	Virage	1989
	Zagato	1988-1987
Asuna	Sunrunner	1992
Audi	4000	1980
	Fox	1979-1973
BMW	2.8 Bavaria	1971
	3.0CS	1974-1971
	3.0CSi	1974-1971
	3.0CSL	1971
	3.0S	1974-1971
	3.0Si	1971
	3.0Si	1976-1975
	318i	1985-1984
	320i	1983-1977
	528i	1981-1979
	530i	1978-1975
	533i	1984-1983
	535i	1988-1985
	535is	1988
	630CSi	1978-1977
	633CSi	1984-1978
	635CSi	1987-1985
	733i	1984-1978
	735i	1987-1985
	2500	1971-1968
2800	1974-1968	
Bavaria	1974-1972	
L6	1987	
Chrysler	Daytona	1987
Citroen	SM	1975-1973
Dodge	Colt	1975-1974



1233 (Cont'd)		BPR5EY	V-Power	1233 (Cont'd)		BPR5EY	V-Power
Qty per Vehicle: 3-12			Box Qty: 4	Qty per Vehicle: 3-12			Box Qty: 4
Geo	Tracker		1995-1989	Suzuki	SJ413		1985
Jaguar	3.8		1966-1960	Toyota	4Runner		1995-1984
	420		1967		Carina		1973-1972
	Mark X		1966-1962		Celica		1985-1973
	Vanden Plas		1987-1982		Corolla		1979-1968
	XJ		1971-1969		Corona		1982-1972
	XJ6		1987-1972		Cressida		1981-1978
	XJS		1978		Crown		1972-1967
	XK150		1961-1958		Land Cruiser		1974-1967
XKE		1971-1961	Land Cruiser			1989-1979	
Land Rover	Defender 90		1995-1994		Mark II		1976-1972
	Defender 90		1997	Pickup		1995-1970	
	Defender 110		1993	Starlet		1982-1981	
	Range Rover		2002-1987	Van Wagon		1988	
Lotus	Elite		1979-1976	Triumph	GT6		1973-1967
	Esprit		1982-1980		Spitfire		1980-1963
Mazda	626		1987-1979		Stag		1973-1971
	B2000		1984-1979		TR7		1982-1975
	B2000		1987-1986		TR8		1982-1980
	B2200		1993-1987	Volkswagen	Dasher		1980-1974
	GLC		1985-1979		Rabbit		1980-1975
Mercedes-Benz	230		1978-1974		Rabbit Convertible		1980
	280		1976-1975		Rabbit Pickup		1980
	280C		1976-1975		Scirocco		1980-1975
	280CE		1981-1978	Volvo	760		1986-1984
	280E		1981-1977		760		1990-1988
	280S		1976-1975		DL		1984
	280SE		1980-1977		GLE		1984
	380SE		1985-1984	Yugo	Cabrio		1992-1990
	380SEC		1983-1982		GV		1992-1986
	380SEL		1983-1981		GVL		1989-1988
	380SL		1985-1981		GVS		1988
	380SLC		1981		GVX		1989-1988
	420SEL		1991-1986	<b>1263 BP6ET Standard</b>			
	450SE		1976-1973	Qty per Vehicle: 4-5			Box Qty: 4
	450SEL		1980-1973	Audi	90		1991-1988
	450SL		1980-1973		200		1991-1989
	450SLC		1980-1973		200 Quattro		1991-1989
	500SEC		1985-1984		4000		1987-1984
	500SEL		1985-1984		4000 Quattro		1987-1984
	560SEC		1991-1986	5000		1984	
560SEL		1991-1986	Peugeot	505		1989-1986	
560SL		1989-1986		Volkswagen	EuroVan		1996-1992
MG	Midget		1966-1962		Fox		1993-1987
	Midget		1979-1975		Golf		1985
Nissan	200SX		1983-1982		Golf		1987
	720		1986-1981		Jetta		1992-1984
	1200		1973-1971		Passat		1993-1991
	2000		1970-1968		Quantum		1988-1985
	B210		1976-1975		Scirocco		1989-1983
	D21		1989-1986	<b>1266 BCPR5EY V-Power</b>			
	F10		1976	Qty per Vehicle: 4-6			Box Qty: 4
	Pathfinder		1988-1987	Geo	Prizm		1992-1990
	Van		1988-1987	Saab	900		1994-1992
	Pontiac	Sunrunner		1994	Toyota	4Runner	
Porsche	911		1979-1978	Celica			1993-1988
	928		1982-1978	Corolla			1992-1988
	944		1984-1983	<b>1273 BCPR5E-11 V-Power</b>			
Renault	Alliance		1987-1983	Qty per Vehicle: 4-6			Box Qty: 4
	Encore		1986-1984	Acura	Integra		1991-1990
	LeCar		1985-1980	Honda	CRX		1991-1988
Suzuki	LJ81		1981		Prelude		1990
	Samurai		1995-1985	Nissan	200SX		1988-1984
	Sidekick		1994-1989		D21		1989-1986
	SJ410		1985-1980				



1273 (Cont'd)		BCPR5E-11	V-Power
Qty per Vehicle: 4-6			Box Qty: 4
Nissan	Multi		1988-1986
	Pathfinder		1989-1987
	Pulsar NX		1990-1989
	Sentra		1990-1989
	Stanza		1989-1984
1275		CR8E	Standard
Qty per Vehicle: 8			Box Qty: 4
Ferrari	F355 Berlinetta		1996-1994
1311		DIFR5C11	Laser Iridium
Qty per Vehicle: 4			Box Qty: 4
Mitsubishi	Lancer		2017-2011
	Outlander		2013-2011
	Outlander Sport		2017-2015
	RVR		2017-2015
1312		DIFR6C11	Laser Iridium
Qty per Vehicle: 4			Box Qty: 4
Mitsubishi	Lancer		2017-2011
	Outlander Sport		2017-2011
	RVR		2017-2011
1313		FR5EI	Laser Iridium
Qty per Vehicle: 4-6			Box Qty: 4
Mitsubishi	Eclipse		2005-2004
	Lancer		2010-2009
	Outlander		2010-2008
1402		SILKR8A-S	Laser Iridium
Qty per Vehicle: 4			Box Qty: 4
Acura	RDX		2012-2007
1406		DILKAR7B11	Laser Iridium
Qty per Vehicle: 6-8			Box Qty: 4
Infiniti	EX35		2012-2008
	FX35		2012-2009
	FX50		2013-2009
	G25		2012-2011
	G35		2008-2007
	JX35		2013
	M35		2010-2009
	M35h		2013-2012
	M56		2013-2011
	Q50		2016-2014
	Q60		2014
	Q70		2017-2014
	Q70L		2017-2015
	QX56		2013-2011
	QX60		2017-2014
	QX70		2014
	QX80		2017-2014
	Nissan	350Z	
Altima			2017-2007
Armada			2017
Maxima			2014-2009
Maxima			2017-2016
Murano			2017-2009
NV2500			2018
NV3500			2018
Pathfinder			2017-2013
Quest			2017-2011
Titan			2017
Titan XD			2017-2016
1422		ILKR8E6	Laser Iridium
Qty per Vehicle: 4			Box Qty: 4
Mitsubishi	Lancer		2010-2008

1465		IZTR5B11	Laser Iridium
Qty per Vehicle: 8			Box Qty: 4
Buick	Allure		2009-2008
	LaCrosse		2009-2008
	Rainier		2007-2004
Cadillac	CTS		2007-2004
	Escalade		2000-1999
	Escalade		2014-2002
	Escalade ESV		2014-2003
	Escalade EXT		2013-2002
Chevrolet	Avalanche		2013-2007
	Avalanche 1500		2006-2002
	C1500		1999-1998
	C1500 Suburban		1999-1998
	C2500		2000-1998
	C2500 Suburban		1999-1998
	C3500		2000-1998
	Camaro		2002-1998
	Camaro		2015-2010
	Caprice		1996-1994
	Caprice		2017-2011
	Colorado		2012-2009
	Corvette		1995-1993
	Corvette		2013-1997
	Express 1500		2014-1998
	Express 2500		2017-1998
	Express 3500		2017-1998
	Express 4500		2016-2009
	Impala		2009-2006
	K1500		1999-1998
	K1500 Suburban		1999-1998
	K2500		2000-1998
	K2500 Suburban		1999-1998
	K3500		2000-1998
	Monte Carlo		2007-2006
	P30		1999-1998
	Silverado 1500		2013-1999
	Silverado 1500 Classic		2007
	Silverado 1500 HD		2003-2001
	Silverado 1500 HD		2006-2005
	Silverado 1500 HD Classic		2007
	Silverado 2500		2004-1999
	Silverado 2500 HD		2017-2001
	Silverado 2500 HD Classic		2007
Silverado 3500		2006-2001	
Silverado 3500 Classic		2007	
Silverado 3500 HD		2017-2007	
SS		2017-2014	
SSR		2006-2003	
Suburban 1500		2014-2000	
Suburban 2500		2013-2000	
Suburban 3500 HD		2017-2016	
Tahoe		2014-1998	
Trailblazer		2009-2006	
Trailblazer EXT		2006-2003	
GMC	C1500		1999-1998
	C1500 Suburban		1999-1998
	C2500		2000-1998
	C2500 Suburban		1999-1998
	C3500		2000-1998
	Canyon		2012-2009
	Envoy		2009-2005
	Envoy XL		2006-2003
	Envoy XUV		2005-2004
	K1500		1999-1998
	K1500 Suburban		1999-1998
	K2500		2000-1998



1465 (Cont'd)		IZTR5B11		Laser Iridium		1483 (Cont'd)		LFR6CGP		G-Power	
Qty per Vehicle: 8				Box Qty: 4		Qty per Vehicle: 4-16				Box Qty: 4	
GMC	K2500 Suburban	1999-1998		Mercedes-Benz	CL55 AMG	2006-2003					
	K3500	2000-1998			CLS55 AMG	2006					
	P3500	1999-1998			E55 AMG	2006-2003					
	Savana 1500	2014-1998			G55 AMG	2011-2005					
	Savana 2500	2017-1998			S55 AMG	2006-2003					
	Savana 3500	2017-1998			SL55 AMG	2008-2003					
	Savana 4500	2016-2009			SLR McLaren	2009-2005					
	Sierra 1500	2013-1999			Mitsubishi	Eclipse	2012-2006				
	Sierra 1500 Classic	2007				Galant	2012-2004				
	Sierra 1500 HD	2003-2001				Lancer	2006-2004				
	Sierra 1500 HD	2006-2005				Outlander	2006-2004				
	Sierra 1500 HD Classic	2007			Saab	9-2X	2006				
	Sierra 2500	2004-1999				9-3	2009-2006				
	Sierra 2500 HD	2017-2001			Subaru	B9 Tribeca	2007-2006				
	Sierra 2500 HD Classic	2007				Baja	2006-2004				
	Sierra 3500	2006-2001				Forester	2013-2004				
	Sierra 3500 Classic	2007				Impreza	2014-2004				
	Sierra 3500 HD	2017-2007				Legacy	2017-2005				
	Yukon	2014-1998				Outback	2017-2001				
	Yukon XL 1500	2014-2000				Tribeca	2014-2008				
Yukon XL 2500	2013-2000		WRX	2014-2013							
Hummer	H2	2009-2003		WRX STI	2018-2013						
	H3	2010-2008		Suzuki	Grand Vitara	2012-2009					
	H3T	2010-2009			Kizashi	2012-2010					
Isuzu	Ascender	2006-2003		Toyota	4Runner	2013-2003					
Lincoln	Town Car	2007-2006			Avalon	2017-2005					
Pontiac	Firebird	2002-1998			Camry	2017-2007					
	G8	2009-2008			FJ Cruiser	2013-2007					
	Grand Prix	2008-2005			Highlander	2016-2008					
Saab	GTO	2006-2004			Land Cruiser	2011-2008					
	9-7x	2009-2005			Land Cruiser	2017-2013					
<b>1483</b>		<b>LFR6CGP</b>			<b>G-Power</b>						
Qty per Vehicle: 4-16					Box Qty: 4						
Acura	ILX	2015-2013			Volvo	RAV4	2012-2006				
BMW	128i	2009-2008				Sequoia	2016-2008				
	323i	2009-2006				Sienna	2016-2007				
	325i	2006				Tacoma	2015-2005				
	325xi	2006		Tundra		2017-2005					
	328i	2009-2007		Venza		2016-2009					
	328i xDrive	2009		C30		2013-2007					
	328xi	2008-2007		C70		2013-2006					
	330i	2006		S40		2011-2004					
	330xi	2006		S60		2009-2004					
	525i	2007-2006		S60		2012-2011					
	525xi	2007-2006		S80		2011-2007					
	528i	2010-2008		V50		2011-2005					
	528i xDrive	2010-2009		V70		2010-2004					
	528xi	2008		XC60		2011-2010					
	530i	2007-2006		XC70		2011-2008					
	530xi	2007-2006		XC90		2011-2007					
	X3	2009-2007		<b>1555</b>		<b>SIZKBR8A8HS</b>		<b>Laser Iridium</b>			
X5	2009-2007		Qty per Vehicle: 8					Box Qty: 4			
Z4	2009-2006		BMW	Alpina B7	2012-2011						
Dodge	Challenger	2017-2015		Alpina B7L	2012-2011						
	Charger	2017-2015		Alpina B7L xDrive	2012-2011						
Honda	Insight	2014-2010		Alpina B7 xDrive	2012-2011						
	Land Rover	LR2	2012-2008		<b>1637</b>		<b>ILFR5B11</b>				
Lexus		ES350	2017-2007		Qty per Vehicle: 6		Box Qty: 4				
	GX460	2017-2010		Hyundai	Genesis	2009					
	LX570	2011-2008			Santa Fe	2009-2007					
	LX570	2017-2013		Kia	Borrego	2009					
	RX350	2015-2007			Magentis	2010-2007					
	RX450h	2015-2010			Optima	2010-2006					
Mercedes-Benz	C230	2005-2003		Rondo	2012-2007						





1643		LKR7E	Standard
Qty per Vehicle: 4			Box Qty: 10
Kia	Soul		2011-2010
1675		PFR7S8EG	Laser Platinum
Qty per Vehicle: 4-10			Box Qty: 4
Audi	A3		2013-2006
	A3 Quattro		2013-2009
	A4		2016-2005
	A4 allroad		2016-2013
	A4 Quattro		2016-2005
	A5		2014-2010
	A5 Quattro		2017-2010
	A6		2015-2012
	A6 Quattro		2015-2013
	allroad		2015-2013
	Q3		2017-2015
	Q3 Quattro		2017-2015
	Q5		2017-2011
	R8		2012-2011
	R8		2015-2014
	R8		2017
	RS5		2015-2013
TT		2009-2008	
TT Quattro		2015-2009	
Volkswagen	Beetle		2013-2012
	CC		2017-2009
	Eos		2016-2007
	Golf		2013
	GTI		2014-2006
	Jetta		2010-2006
	Jetta		2013-2012
	Passat		2010-2006
	Passat CC		2010-2009
	Tiguan		2017-2009
1682		DCPR7EGP	G-Power
Qty per Vehicle: 4			Box Qty: 4
Chevrolet	Spark		2015-2013
Fiat	500		2017-2012
1698		ZNAR6AGP	G-Power
Qty per Vehicle: 8-10			Box Qty: 4
Ford	Expedition		2014-2008
	Explorer		2010-2008
	Explorer Sport Trac		2010-2008
	F53		2009-2008
	F53		2017-2011
	F59		2017-2011
	F650		2013-2012
	F-150		2010-2008
	F-250 Super Duty		2010-2008
	F-350 Super Duty		2010-2008
	F-450 Super Duty		2017-2008
	F-550 Super Duty		2017-2008
	Mustang		2010-2008
Lincoln	Mark LT		2008
	Navigator		2014-2008
Mercury	Mountaineer		2010-2008
1959		PLFR6C-10G	Laser Platinum
Qty per Vehicle: 6			Box Qty: 4
Saab	9-3		2009-2006
1961		ILZKR7A	Laser Iridium
Qty per Vehicle: 6-16			Box Qty: 4
Audi	Q7		2010-2007
Bugatti	Veyron 16.4		2006
Porsche	Cayenne		2010-2008
Volkswagen	CC		2017-2009

1961 (Cont'd)		ILZKR7A	Laser Iridium	
Qty per Vehicle: 6-16			Box Qty: 4	
Volkswagen	Passat		2010-2006	
	Passat		2017-2012	
	Passat CC		2010-2009	
	Touareg		2016-2007	
1989		ILKR7B8	Laser Iridium	
Qty per Vehicle: 3-6			Box Qty: 4	
Kia	Soul		2011-2010	
Mitsubishi	Outlander		2013-2007	
Smart	Fortwo		2015-2008	
2087		BKR5EYA	V-Power	
Qty per Vehicle: 4-6			Box Qty: 4	
Geo	Prizm		1997-1993	
Lexus	LX450		1997-1996	
Scion	xA		2006-2004	
	xB		2006-2004	
Toyota	4Runner		2000-1989	
	Celica		1997-1994	
	Corolla		1997-1993	
	Echo		2005-2001	
	Land Cruiser		1997-1993	
	Pickup		1995-1988	
	T100		1998-1993	
	Tacoma		1999-1995	
	2095		BKR7EKC-N	Standard
	Qty per Vehicle: 6			Box Qty: 10
Porsche	911		2005-2004	
2097		BCPR5EP-11	Laser Platinum	
Qty per Vehicle: 4-6			Box Qty: 4	
Acura	Integra		1991-1990	
Chevrolet	Nova		1988	
Honda	CRX		1991-1988	
	Prelude		1990-1988	
Nissan	200SX		1988-1984	
	D21		1989-1986	
	Multi		1988-1986	
	Pathfinder		1989-1987	
	Pulsar NX		1990-1989	
	Sentra		1990-1989	
	Stanza		1989-1984	
	Toyota	Camry		1991-1987
Toyota	Celica		1989-1986	
	Corolla		1989-1985	
	Cressida		1992-1989	
	MR2		1989-1985	
	Supra		1992-1986	
	2115		BPR5EIX-11	Iridium IX
Qty per Vehicle: 3-6			Box Qty: 4	
Chevrolet	Nova		1988-1985	
	Sprint		1992-1989	
Chrysler	Daytona		1993-1990	
	Dynasty		1990-1988	
	E Class		1984-1983	
	Executive Limousine		1985	
	Executive Sedan		1984-1983	
	Grand Voyager		2000	
	LeBaron		1985-1982	
	LeBaron		1995-1990	
	New Yorker		1985-1983	
	New Yorker		1989-1988	
	TC Maserati		1991-1990	
	Town & Country		1982	
	Town & Country		1985-1984	
	Voyager		2000	



2115 (Cont'd)		BPR5EIX-11	Iridium IX	2115 (Cont'd)		BPR5EIX-11	Iridium IX	
Qty per Vehicle: 3-6			Box Qty: 4	Qty per Vehicle: 3-6			Box Qty: 4	
Daihatsu	Charade		1992-1988	Plymouth	Grand Voyager		1989-1987	
Dodge	400		1983-1982		Grand Voyager		2000-1992	
	600		1985-1983		Reliant		1985-1981	
	Aries		1985-1981		Sapporo		1983-1978	
	Caravan		2000-1984		Sundance		1994-1992	
	Challenger		1983-1978		Voyager		2000-1984	
	Colt		1980-1978		Toyota	Camry		1986-1983
	Colt		1995-1991			Celica		1986-1982
	D50		1982-1979			Corolla		1988-1980
	Daytona		1993-1990			Cressida		1988-1982
	Dynasty		1993-1988	Land Cruiser			1978-1975	
	Grand Caravan		1989-1987	Land Cruiser			1992-1990	
	Grand Caravan		2000-1992	Starlet			1984-1983	
	Mini Ram		1988-1987	Tercel			1994-1981	
	Power Ram 50		1983	Van			1989-1984	
	Raider		1989	<b>2215 BKR6EP-8 Laser Platinum</b>				
	Ram 50		1983	Qty per Vehicle: 4-8			Box Qty: 4	
	Ram 50		1991-1990	Geo	Prizm		1992-1990	
	Shadow		1994-1992	Mitsubishi	Eclipse		1998-1995	
Spirit		1995-1989	Eclipse			2012-2006		
Stealth		1996-1991	Galant			2009-2007		
Eagle	Summit		1996-1989	Toyota	Celica		1993-1990	
	Vista		1992-1988		Corolla		1992-1990	
Honda	Accord		1989-1986		MR2		1995-1991	
	Civic		1973		Sequoia		2004-2001	
	Passport		1996-1994		Tundra		2004-2000	
Hyundai	Prelude		1987-1985	<b>2238 TR5 V-Power</b>				
	Santa Fe		2006-2001	Qty per Vehicle: 4-12			Box Qty: 4	
Hyundai	Sonata		2005-1990	Aston Martin	DB7		2004	
	Isuzu	Amigo	1994-1989	Audi	V8 Quattro		1991-1990	
Isuzu	Pickup		1995-1992	Buick	Allure		2009-2008	
	Rodeo		1997-1991		Century		1988-1986	
	Trooper		1991-1988		Electra		1987-1986	
Kia	Magentis		2006-2001		LaCrosse		2009-2008	
	Optima		2006-2001		LeSabre		1988-1986	
	Sephia		1995-1994		Rainier		2007-2004	
Mazda	323		1995-1986		Riviera		1987-1986	
	B2200		1993-1990		Skylark		1988-1986	
	B2600		1988-1987		Somerset		1987-1986	
Mitsubishi	3000GT		1999-1997		Somerset Regal		1985	
	Galant		1988-1985	Cadillac	CTS		2007-2004	
	Mighty Max		1985-1983		Escalade		2000-1999	
	Mighty Max		1994-1990		Escalade		2014-2002	
	Mirage		1999-1991		Escalade ESV		2014-2003	
	Montero		1985-1983		Escalade EXT		2013-2002	
	Montero		1994-1989		SRX		2006-2004	
	Sigma		1990-1989		STS		2006-2005	
Nissan	210		1982-1979		XLR		2006-2004	
Nissan	280Z		1978-1977		Chevrolet	Avalanche		2013-2007
	280ZX		1980-1979			Avalanche 1500		2006-2002
	310		1982-1979	C1500			1999-1998	
	810		1979-1977	C1500 Suburban			1999-1998	
	B210		1978-1977	C2500			2000-1998	
	F10		1978-1977	C2500 Suburban			1999-1998	
	Micra		1991-1984	C3500			2000-1998	
	Pulsar		1983	Camaro			2002-1998	
	Pulsar NX		1988-1983	Camaro			2015-2010	
	Sentra		1986-1982	Caprice			2017-2011	
	Stanza		1983-1982	Cavalier		2002-1999		
	Plymouth	Acclaim		1995-1989	Colorado		2012-2009	
Arrow			1980-1979	Corvette		2013-1993		
Arrow Pickup			1982-1979	Express 1500		2014-1998		
Caravelle			1985-1983	Express 2500		2017-1998		
Colt			1980-1978	Express 3500		2017-1998		
Colt			1992-1991					



2238 (Cont'd)	TR5	V-Power	2238 (Cont'd)	TR5	V-Power	
Qty per Vehicle: 4-12		Box Qty: 4	Qty per Vehicle: 4-12		Box Qty: 4	
Chevrolet	Express 4500	2016-2009	Ford	Mustang	2000	
	Impala	2009-2006		Mustang II	1978-1974	
	K1500	1999-1998		Pinto	1980-1974	
	K1500 Suburban	1999-1998		Probe	1992-1990	
	K2500	2000-1998		Ranger	2009-1983	
	K2500 Suburban	1999-1998		Taurus	2007-1986	
	K3500	2000-1998		Tempo	1989-1984	
	Lumina	1995-1991		Tempo	1994-1992	
	Monte Carlo	1995		Thunderbird	1988-1983	
	Monte Carlo	2007-2006		Windstar	2000-1995	
	P30	1999-1998		GMC	C1500	1999-1998
	S10	2001-1999			C1500 Suburban	1999-1998
	S10	2003			C2500	2000-1998
	Silverado 1500	2013-1999			C2500 Suburban	1999-1998
	Silverado 1500 Classic	2007	C3500		2000-1998	
	Silverado 1500 HD	2003-2001	Canyon		2012-2009	
	Silverado 1500 HD	2006-2005	Envoy		2009-2005	
	Silverado 1500 HD Classic	2007	Envoy XL		2006-2003	
	Silverado 2500	2004-1999	Envoy XUV		2005-2004	
	Silverado 2500 HD	2017-2001	K1500		1999-1998	
	Silverado 2500 HD Classic	2007	K1500 Suburban		1999-1998	
	Silverado 3500	2006-2001	K2500		2000-1998	
	Silverado 3500 Classic	2007	K2500 Suburban		1999-1998	
	Silverado 3500 HD	2017-2007	K3500		2000-1998	
	SS	2017-2014	P3500		1999-1998	
	SSR	2006-2003	Savana 1500		2014-1998	
	Suburban 1500	2014-2000	Savana 2500		2017-1998	
Suburban 2500	2013-2000	Savana 3500	2017-1998			
Suburban 3500 HD	2017-2016	Savana 4500	2016-2009			
Tahoe	2014-1998	Sierra 1500	2013-1999			
Trailblazer	2009-2006	Sierra 1500 Classic	2007			
Trailblazer EXT	2006-2003	Sierra 1500 HD	2003-2001			
Vega	1976-1975	Sierra 1500 HD	2006-2005			
DeLorean	DMC 12	1983-1981	Sierra 1500 HD Classic	2007		
Dodge	Monaco	1992-1990	Sierra 2500	2004-1999		
Eagle	Medallion	1989-1988	Sierra 2500 HD	2017-2001		
	Premier	1992-1988	Sierra 2500 HD Classic	2007		
Ford	Aerostar	1997-1986	Sierra 3500	2006-2001		
	Bronco II	1990-1984	Sierra 3500 Classic	2007		
	Courier	1982-1977	Sierra 3500 HD	2017-2007		
	E-250	2005-2003	Sonoma	2003-1998		
	E-250 Econoline	2002-1997	Yukon	2014-1998		
	E-350 Club Wagon	2005-2003	Yukon XL 1500	2014-2000		
	E-350 Econoline	1998-1997	Yukon XL 2500	2013-2000		
	E-350 Econoline Club Wagon	2002-1997	Hummer	H2	2009-2003	
	E-350 Super Duty	2005-1999		H3	2010-2008	
	E-450 Econoline Super Duty	2002-2000		H3T	2010-2009	
	Econoline Super Duty	1999	Isuzu	Ascender	2006-2003	
	Escape	2012-2009		Hombre	2000-1998	
	Escort	1985-1982	Jaguar	XJ12	1988-1981	
	EXP	1985-1982		XJS	1977	
	F-100	1983		XJS	1988-1979	
	F-150	1995-1993	Lincoln	Town Car	2010-2006	
	F-150	1998-1997		Mazda	6	2008-2003
	F-150	2003-2000	B2300		1997-1994	
	F-150	2010	B2300		2010-2001	
	F-150 Heritage	2004	B2500		2001-1998	
	F-250	1999-1997	B3000		2003-1994	
	Fairmont	1982-1978	MPV		2001-2000	
	Fiesta	1980	Tribute		2011-2009	
	Fusion	2012-2010	Mercedes-Benz		190E	1993-1984
	Granada	1982-1981			260E	1989-1987
	LTD	1985-1983			300CE	1989-1988
	Mustang	1986-1979		300E	1993-1986	
	Mustang	1993-1991		300SE	1991-1988	



2238 (Cont'd)		TR5	V-Power	2248 (Cont'd)		UR55	V-Power	
Qty per Vehicle: 4-12			Box Qty: 4	Qty per Vehicle: 4-8			Box Qty: 4	
Mercedes-Benz	300SEL		1991-1988	GMC	S15		1990-1985	
	300TE		1993-1988		S15 Jimmy		1988-1985	
Mercury	Bobcat		1980-1975		Safari		1990-1985	
	Capri		1977-1976		Sonoma		1993-1991	
	Capri		1984-1979	Oldsmobile	Calais		1987-1985	
	Cougar		1982-1981		Cutlass Calais		1991-1988	
	Cougar		1986-1984		Cutlass Ciera		1992-1984	
	LN7		1983-1982		Cutlass Cruiser		1990-1987	
	Lynx		1982		Omega		1984	
	Lynx		1985-1984	Starfire		1978		
	Mariner		2011-2009	Pontiac	6000		1991-1984	
	Marquis		1984-1983		Astre		1975	
	Milan		2011-2010		Fiero		1988-1984	
	Sable		2005-1986		Firebird		1986-1984	
	Topaz		1988-1984		Grand Am		1991-1985	
	Topaz		1994-1992		Phoenix		1978	
Zephyr		1982-1978	Phoenix			1984		
Merkur	Scorpio		1989-1988	Sunbird		1978		
	XR4Ti		1989-1985	<b>2262 ZFR5F-11 V-Power</b>				
Oldsmobile	98		1987-1986	Qty per Vehicle: 4-10			Box Qty: 4	
	Calais		1987-1985	Acura	CL		1999-1997	
	Cutlass Calais		1988		CL		2003-2001	
	Cutlass Ciera		1988-1986		EL		2000-1997	
	Cutlass Cruiser		1988-1987		Integra		2001-1992	
	Cutlass Supreme		1995-1991		MDX		2002-2001	
	Delta 88		1988-1986	TL		2003-1999		
	Toronado		1987-1986	Chrysler	200		2014-2011	
Panoz	AIV Roadster		Sebring			2007		
Esperante		2000-1999	Sebring			2010-2009		
Peugeot	505		1991-1987	Dodge	Avenger		2014-2008	
	604		1981-1977		Caliber		2012-2007	
Pontiac	Bonneville		1988-1987		Dakota		2007-2000	
	Firebird		2002-1998		Journey		2017-2009	
	G8		2009-2008		Ram 2500		1996-1994	
	Grand Am		1987-1985		Ram 3500		1996-1994	
	Grand Prix		1995-1991	Honda	Accord		2002-1990	
	Grand Prix		2008-2005		Civic		2000-1992	
	GTO		2006-2004		Civic del Sol		1997-1993	
	Sunfire		2002-1999		CR-V		1998-1997	
Renault	Fuego		1985-1984		Odyssey		2004-1995	
R18i		1986-1984	Pilot			2005-2003		
Saab	9-7x		2009-2005	Prelude		1996-1990		
Volvo	262		1976	Hyundai	Elantra		2012-2007	
	262		1981-1978	Isuzu	Oasis		1999-1996	
	264		1982-1976	Jeep	Compass		2017-2007	
	265		1981-1976		Patriot		2017-2007	
	760		1990-1983	Kia	Soul		2011-2010	
	780		1990-1987		Spectra		2009-2008	
			Spectra5			2009-2008		
<b>2248</b>		<b>UR55</b>	<b>V-Power</b>	Mazda	626		1997-1993	
Qty per Vehicle: 4-8			Box Qty: 4		929		1991-1990	
Buick	Century		1992-1984		B2600		1993-1990	
	Skylark		1991-1983		Millenia		2002-1995	
	Somerset		1987-1986		MPV		1995-1990	
	Somerset Regal		1985		MX-6		1997-1993	
Chevrolet	Astro		1990-1985		Protege		2003-1999	
	Camaro		1986-1984		Mitsubishi	Raider		2007-2006
	Celebrity		1990-1984		<b>2271 PFR5C-11 Laser Platinum</b>			
	Citation II		1985-1984		Qty per Vehicle: 4-6			Box Qty: 4
	LLV		1993-1987	Nissan	240SX		1998-1994	
	Lumina		1992-1990		Maxima		1994-1992	
	Monza		1978	<b>2288 BKR6EK Standard</b>				
	S10		1993-1985	Qty per Vehicle: 4-12			Box Qty: 4	
S10 Blazer		1988-1985	BMW	318i		1999-1991		
Vega		1975						
Ford	E-350 Econoline Club Wagon		1996-1992					



2288 (Cont'd)	BKR6EK	Standard
Qty per Vehicle: 4-12		Box Qty: 4
BMW	318is	1999-1991
	318ti	1999-1995
	325i	1995-1992
	325is	1995-1992
	525i	1995-1991
	525iT	1993
	530i	1995-1994
	540i	1995-1994
	540i	1997
	740i	1995-1993
	740i	1997
	740iL	1997-1993
	840Ci	1997-1994
M3	1995-1994	
Z3	1998-1996	
Chevrolet	Opra	2007-2005
Daewoo	Leganza	2002-1999
Porsche	911	1994-1990
	911	1997-1996
	911	2001-1999
	911	2005-2003
	Boxster	2002-1997
Saab	900	1997-1994
	9000	1997-1995
Suzuki	Forenza	2008-2004
	Reno	2008-2005
2300	PFR5B-11	Laser Platinum
Qty per Vehicle: 4-8		Box Qty: 4
Infiniti	Q45	1993-1990
	QX4	1997
Nissan	240SX	1993-1991
	300ZX	1996-1990
	Altima	1998-1993
	Frontier	1998
	NX	1993-1991
	Pathfinder	1997-1996
	Sentra	1999-1991
Subaru	Forester	1998
	Impreza	1998
	Legacy	1999-1996
2309	LFR7AIX	Iridium IX
Qty per Vehicle: 4		Box Qty: 4
Mitsubishi	Lancer	2006
2313	LZTR4AIX-11	Iridium IX
Qty per Vehicle: 4-16		Box Qty: 4
Chrysler	300	2008-2005
	Aspen	2008-2007
	PT Cruiser	2010-2001
	Sebring	2006-2001
	Voyager	2003-2001
Dodge	Caravan	2007-2001
	Charger	2008-2006
	Durango	2008-2004
	Magnum	2008-2005
	Ram 1500	2008-2003
	Ram 2500	2008-2003
	Ram 3500	2008-2003
	Stratus	2005-2004
Jeep	Commander	2008-2006
	Grand Cherokee	2008-2005
	Liberty	2005-2002
	TJ	2003
	TJ	2006-2005
	Wrangler	2006-2003

2314	LZTR5AIX-13	Iridium IX	
Qty per Vehicle: 4-16		Box Qty: 4	
Chrysler	300	2010-2005	
	Concorde	2004-1998	
	Intrepid	2004-1998	
	Pacifica	2008-2005	
	PT Cruiser	2009-2003	
	Sebring	2010-2001	
	Town & Country	2010-2001	
	Voyager	2003-2001	
	Dodge	Avenger	2010-2008
		Caravan	2007-2001
		Challenger	2010-2008
Charger		2010-2006	
Grand Caravan		2010-2001	
Intrepid		2004-1998	
Magnum		2008-2005	
Neon		2005-2003	
Stratus		2006-2001	
Viper		2010-2008	
Jeep	Viper	2017-2015	
	Grand Cherokee	2010-2006	
SRT	Wrangler	2011-2007	
	Viper	2014-2013	
Volkswagen	Routan	2010-2009	

2316	DCPR9EIX	Iridium IX
Qty per Vehicle: 12		Box Qty: 4
Ferrari	456 GT	1998-1995
	456 GTA	1998-1997
	456 M	2001-1999
	456 M GT	2004-2002
	456 M GTA	2004-2002
	512 M	1995
	512 TR	1994-1992
	550 Maranello	2002-1997
	575 M Maranello	2005-2002
	612 Scaglietti	2010-2005
Superamerica	2005	

2329	BR8EQ-14	Standard
Qty per Vehicle: 4		Box Qty: 4
Mazda	RX-7	1985-1981

2330	BCPR6ES	Standard
Qty per Vehicle: 4-8		Box Qty: 4
Aston Martin	Virage	1994-1990
Morgan	4/4	1994-1982
Saab	900	1998-1985
	9000	1990-1986
Toyota	Supra	1992-1987

2341	PFR6G-13E	Laser Platinum
Qty per Vehicle: 8		Box Qty: 4
Jaguar	Vanden Plas	2003
	XJR	2003-1998
	XKR	2003

2380	PFR7G-11	Laser Platinum
Qty per Vehicle: 4-6		Box Qty: 4
Acura	Integra	2001
Saab	9-5	2003-1999

2382	BKR5ES-11	Standard
Qty per Vehicle: 4-16		Box Qty: 4
Acura	RL	2004-1996
	SLX	1999-1996
	TL	1998-1995
	Vigor	1994-1992
Chevrolet	Corvette	1992-1990
	Prizm	2002-2000





2382 (Cont'd)		BKR5ES-11	Standard	2382 (Cont'd)		BKR5ES-11	Standard	
Qty per Vehicle: 4-16			Box Qty: 4	Qty per Vehicle: 4-16			Box Qty: 4	
Chevrolet	Tracker		2004-2001	Lexus	SC300		1992	
Chrysler	Cirrus		2000-1995		SC300		1998-1994	
	Crossfire		2008-2004	Lincoln	LS		2006-2000	
	Sebring		2005-1995	Mazda	2		2014-2011	
Dodge	Avenger		2000-1995		323		1991-1990	
	Colt		1994-1993		323		1994-1993	
	Stratus		2000-1995		626		2002-1993	
Eagle	Summit		1996-1992		929		1995-1992	
Ford	Taurus		1995-1989		Miata		1997-1994	
	Thunderbird		2005-2002		Miata		2005-1999	
Geo	Prizm		1989		MPV		1998-1996	
	Storm		1993-1992		MX-3		1996-1992	
Honda	Civic		2005-2003		MX-6		1997-1993	
	Passport		2002-1997		Protege		2003-1990	
Hyundai	Accent		2011-1995		Protege5		2003-2002	
	Azera		2011-2006		Mercedes-Benz	C240		2005-2003
	Elantra		2007-1996			C280		1998
	Entourage		2010-2007			C320		2005-2003
	Santa Fe		2009-2001	CL500			2006-2003	
	Scoupe		1995-1993	CLK320			2005-2003	
	Sonata		2010-1999	CLK430			2003	
	Tiburon		2001-1997	CLK500			2006-2003	
	Tiburon		2008-2003	CLS500			2006	
	Tucson		2009-2005	E320			2005-2003	
	Veracruz		2012-2007	E500			2006-2003	
	XG300		2001	G55 AMG			2004-2003	
	XG350		2005-2002	G500			2008-2003	
Infiniti	G20		2002-1999	ML55 AMG			2003	
	I30		2001-1996	ML320			2003	
	J30		1997-1993	ML350			2005-2003	
	Q45		2001-1990	ML500		2004-2003		
	QX4		2000-1997	ML500		2007		
Isuzu	Amigo		2000-1998	R500		2007-2006		
	Axiom		2003-2002	S430		2006-2003		
	Rodeo		2002-1996	S500		2006-2000		
	Rodeo Sport		2002-2001	SL500		2000-1999		
	Trooper		2002-1996	SL500		2006-2003		
	VehiCROSS		2001-1999	SLK320		2004-2003		
Jaguar	S-Type		2008-2000	Mercury	Villager		2002-1999	
	Super V8		2009-2005	Mitsubishi	Diamante		2004-1997	
	Vanden Plas		2009-1997		Eclipse		2005-1996	
	XF		2010-2009		Expo		1995-1993	
	XJ8		2009-1998		Expo LRV		1994-1992	
	XJR		2009-2004		Galant		2003-1992	
	XK		2009-2007		Lancer		2007-2002	
	XK8		2006-1997		Mirage		2002-1993	
	XKR		2002-2000		Montero		2002-1994	
	XKR		2009-2004		Montero Sport		2004-1997	
			Outlander			2003		
Kia	Amanti		2006-2004	Nissan	240SX		1998-1991	
	Magentis		2006-2001		300ZX		1996-1990	
	Optima		2006-2001		Altima		2001-1993	
	Rio		2011-2006		Frontier		2004-1998	
	Rio5		2011-2006		Maxima		2001-1992	
	Rondo		2008-2007		NX		1993-1991	
	Sedona		2012-2002		Pathfinder		2000-1996	
	Sedona		2014		Quest		2002-1999	
	Sephia		1997-1995		Sentra		2001-1991	
	Sorento		2009-2003		Xterra		2004-2000	
	Spectra		2007-2004	Plymouth	Colt		1994-1993	
	Spectra5		2007-2005		Pontiac	Vibe		2008-2003
	Sportage		2010-2005	Saab	9-2X		2006	
Land Rover	LR3		2009-2005		Scion	xB		2015-2012
	Range Rover		2009-2006	Subaru		Baja		2006-2004
	Range Rover Sport		2009-2006		Forester		1998	
Lexus	GS300		1997-1994					



2382 (Cont'd)	BKR5E-11	Standard
Qty per Vehicle: 4-16		Box Qty: 4
Subaru	Forester	2010-2005
	Impreza	1998
	Impreza	2011-2005
	Legacy	1999-1996
	Legacy	2009-2005
	Outback	2009-2004
Suzuki	Aerio	2007-2002
	Grand Vitara	2005-2000
	SX4	2009-2007
	Vitara	2004-2000
	XL-7	2003-2002
Toyota	4Runner	2000
	Celica	1990
	Celica	2005-2000
	Corolla	2008-2000
	Corolla	2012
	Echo	2000
	Matrix	2008-2003
	Matrix	2013-2012
	MR2	1991
	MR2 Spyder	2005-2000
	Paseo	1995-1992
	Previa	1995-1991
	Prius	2009-2001
	Supra	1997-1993
Tacoma	2004-2000	
Yaris	2017-2006	
Volkswagen	Beetle	2004

2391	BKR5E-N-11	V-Power
Qty per Vehicle: 5-6		Box Qty: 4
Acura	RL	2002-1996
	SLX	1999-1996
	TL	1998-1995
	Vigor	1994-1992
Honda	Passport	2002-1997

2397	BKUR6ET-10	Standard
Qty per Vehicle: 4-6		Box Qty: 4
Audi	90	1995-1993
	90 Quattro	1995-1993
	100	1994-1992
	100 Quattro	1994-1992
	A4	1998-1997
	A4 Quattro	1997
	A6	1997-1995
	A6 Quattro	1997
	Cabriolet	1994
	Cabriolet	1998-1997
Mercedes-Benz	C230	2000-1999
Volkswagen	Beetle	2001-1998
	Beetle	2003
	Golf	2001-1999
	Jetta	2001-1999

2438	WR5	V-Power
Qty per Vehicle: 4-8		Box Qty: 4
Dodge	Ram 3500	1995-1994
Ford	Bronco	1974-1966
	Bronco	1986-1980
	Club	1959-1955
	Club Wagon	1965-1962
	Club Wagon	1967
	Country Sedan	1974-1955
	Country Squire	1974-1955
	Courier Sedan Delivery	1960-1955
Custom	1957	

2438 (Cont'd)	WR5	V-Power
Qty per Vehicle: 4-8		Box Qty: 4
Ford	Custom	1972-1964
	Custom 300	1960-1958
	Custom 500	1974-1964
	Customline	1956-1955
	Del Rio Wagon	1958-1957
	E-100 Econoline	1983-1969
	E-100 Econoline Club Wagon	1983-1975
	E-150 Econoline	1986-1975
	E-150 Econoline Club Wagon	1986-1975
	E-200 Econoline	1974-1969
	E-250 Econoline	1986-1975
	E-250 Econoline Club Wagon	1980-1977
	E-250 Econoline Club Wagon	1986-1983
	E-300 Econoline	1974-1969
	E-350 Econoline	1986-1975
	E-350 Econoline Club Wagon	1986-1977
	Econoline	1967-1961
	F-100	1983-1961
	F-150	1986-1975
	F-250	1986-1961
	F-350	1986-1961
	F-500	1977-1975
	Fairlane	1970-1955
	Fairmont	1983-1978
	Falcon	1970-1960
	Falcon Sedan Delivery	1965-1961
	Ford 300	1963
	F Series	1959-1957
	Galaxie	1967-1959
	Galaxie 500	1974-1968
	Granada	1982-1975
	Gran Torino	1974-1972
	LTD	1974-1965
	LTD	1983
	M-400	1971
	M-400	1973
	M-450	1974
	Mainline	1956-1955
	Maverick	1977-1970
	Mustang	1973-1964
	Mustang	1982-1979
	P-100	1966-1965
	P-350	1976-1965
	P-400	1976-1975
P-500	1977-1975	
Park Lane Wagon	1956	
Pinto	1974-1971	
Ranchero	1974-1957	
Ranch Wagon	1974-1955	
Skyliner	1959-1955	
Sprint	1964-1963	
Starliner	1960	
Sunliner	1960-1955	
Thunderbird	1973-1955	
Thunderbird	1982-1980	
Torino	1974-1968	
Victoria	1960-1955	
Lincoln	Capri	1959-1952
	Continental	1972-1958
	Cosmopolitan	1954-1952
	Custom	1955
	Lincoln Series	1960
	Mark II	1957-1956
	Mark III	1971-1968
	Mark IV	1972



2438 (Cont'd)		WR5	V-Power	2460 (Cont'd)		BKR5ES	Standard
Qty per Vehicle: 4-8			Box Qty: 4	Qty per Vehicle: 4-24			Box Qty: 4
Lincoln	Premier		1960-1956	Jaguar	XJR		1997
Mercury	Brougham		1967	Jeep	Cherokee		1990-1987
	Caliente		1967-1964		Comanche		1990-1987
	Capri		1967-1966		Wagoneer		1990-1987
	Capri		1974-1971	Kia	Magentis		2008-2007
	Capri		1982-1979		Optima		2008-2007
	Colony Park		1973-1957		Sportage		1995
	Comet		1969-1960	Lexus	LX450		1997-1996
	Comet		1977-1971	Mazda	Miata		2005-2004
	Commuter		1962-1957	Mercedes-Benz	300CE		1993-1990
	Commuter		1968-1964		300E		1993
	Cougar		1970-1967		300SE		1993-1992
	Cougar		1974		300SL		1993-1990
	Cougar		1982-1980		300TE		1993
	Country Cruiser		1960-1959		400E		1993-1992
	Country Cruiser		1963		400SE		1992
	Custom		1956-1955		400SEL		1993
	Cyclone		1971-1964		500E		1993-1992
	Marauder		1967-1963		500SEC		1993
	Marauder		1970-1969		500SEL		1993-1992
	Marquis		1973-1967		500SL		1993-1990
	Marquis		1983		600SEC		1993
	Medalist		1956		600SEL		1993-1992
	Medalist		1958		600SL		1993
	Meteor		1963-1961		C36 AMG		1997-1995
	Monarch		1980-1975		C43 AMG		2000-1998
	Montclair		1960-1955		C220		1996-1994
	Montclair		1968-1964		C230		1998-1997
	Montego		1974-1968		C240		2002-2001
	Monterey		1973-1955		C280		1997-1994
	Park Lane		1959-1958		C280		2000-1999
	Park Lane		1968-1964		C320		2002-2001
	Turnpike Cruiser		1957		CL55 AMG		2002-2001
	Villager		1967-1962		CL500		2002-1998
Voyager		1959-1957	CL600			1999-1998	
Voyager		1967-1966	CL600			2001	
Zephyr		1983-1978	CLK55 AMG		2002-2001		
			CLK320		2002-1998		
			CLK430		2002-1999		
			E55 AMG		2002-1999		
			E320		2002-1994		
			E420		1995-1994		
			E420		1997		
			E430		2002-1998		
			E500		1994		
			G500		2002		
			ML55 AMG		2002-2000		
			ML320		2002-1998		
			ML430		2001-1999		
			ML500		2002		
			S55 AMG		2002-2001		
			S320		1999-1994		
			S420		1999-1994		
			S430		2002-2000		
			S500		1999-1994		
			S600		1999-1994		
			S600		2001		
			SL320		1997-1994		
			SL500		1998-1994		
			SL500		2002-2001		
			SL600		2002-1994		
			SLK320		2002-2001		
			Mercury	Villager		1998-1993	
			Nissan	Quest		1998-1993	
			Oldsmobile	Achieva		1994-1992	
<b>2441</b>		<b>BCPR5EY-11</b>	<b>V-Power</b>				
Qty per Vehicle: 4-6			Box Qty: 4				
Chevrolet	Nova		1988				
Honda	Prelude		1989-1988				
Toyota	Camry		1991-1987				
	Celica		1989-1986				
	Corolla		1989-1985				
	Cressida		1992-1989				
	MR2		1989-1985				
	Supra		1992-1986				
<b>2460</b>		<b>BKR5ES</b>	<b>Standard</b>				
Qty per Vehicle: 4-24			Box Qty: 4				
Bentley	Amage		2009-2000				
	Azure		2003-1996				
	Azure		2008-2006				
	Brooklands		1998-1993				
	Continental		2003-1985				
	Corniche		1984				
	Eight		1984				
	Eight		1991-1986				
	Mulsanne		1992-1984				
		Turbo R		1998-1988			
Chevrolet	Beretta		1994-1992				
Dodge	Ram 2500		1996-1995				
	Ram 3500		1997-1996				
Geo	Prizm		1997-1993				
Hyundai	Sonata		2006				



2460 (Cont'd)	BKR5ES	Standard
Qty per Vehicle: 4-24		Box Qty: 4
Peugeot	405	1991-1989
Pontiac	Grand Am	1994-1993
Rolls-Royce	Corniche	2002-2000
	Silver Dawn	1997-1995
Scion	xA	2006-2004
	xB	2006-2004
Toyota	4Runner	2000-1989
	Celica	1997-1994
	Corolla	1997-1993
	Echo	2005-2001
	Land Cruiser	1997-1993
	Pickup	1995-1988
	T100	1998-1993
Volkswagen	Tacoma	1999-1995
	Cabrio	2001-1995
	Golf	1999-1994
	Jetta	1999-1993
Passat	1996-1995	
2467	PTR5A-13	Laser Platinum
Qty per Vehicle: 4-6		Box Qty: 4
Chevrolet	Cavalier	2004-2003
	Colorado	2006-2004
	Colorado	2009-2008
	Trailblazer	2005-2003
	Trailblazer	2009-2008
	Trailblazer EXT	2005-2002
Ford	C-Max	2017-2013
	Contour	2000-1995
	Edge	2011-2007
	Escape	2004-2001
	Escape	2017-2009
	Escort	2003-1998
	Flex	2012-2009
	Focus	2004-2000
	Fusion	2018-2006
	Taurus	2012-2008
Taurus X	2009-2008	
Transit Connect	2017-2014	
GMC	Canyon	2004
	Canyon	2009-2008
	Envoy	2005-2003
	Envoy	2009-2008
	Envoy XL	2005-2002
Envoy XUV	2005-2004	
Hummer	H3	2009-2007
	H3T	2009
Lincoln	MKS	2013-2009
	MKT	2012-2010
	MKX	2010-2007
	MKZ	2017-2007
Mazda	3	2013-2006
	3 Sport	2010-2009
	3 Sport	2013-2012
	5	2010-2008
	5	2015-2012
	6	2013-2006
	CX-7	2012-2010
	Tribute	2004-2001
	Tribute	2011-2009
Mercury	Cougar	2002-1999
	Mariner	2011-2009
	Milan	2011-2006
	Mystique	2000-1995
	Sable	2009-2008
Oldsmobile	Bravada	2003

2467 (Cont'd)	PTR5A-13	Laser Platinum
Qty per Vehicle: 4-6		Box Qty: 4
Saab	9-7x	2009-2006
2477	ZFR5FIX-11	Iridium IX
Qty per Vehicle: 4-12		Box Qty: 4
Acura	CL	1999-1997
	CL	2003-2001
	EL	2000-1997
	Integra	2001-1992
	MDX	2002-2001
BMW	TL	2003-1999
	750iL	1996-1988
	850Ci	1997-1993
	850CSi	1995-1994
Chrysler	850i	1992-1991
	200	2014-2011
	Sebring	2007
Dodge	Sebring	2010-2009
	Avenger	2014-2008
	Caliber	2012-2007
Dodge	Dakota	2007-2003
	Journey	2017-2009
	Ram 2500	1996-1994
	Ram 3500	1996-1994
	Accord	2002-1990
	Honda	Civic
Civic del Sol		1997-1993
CR-V		1998-1997
Odyssey		2004-1995
Pilot		2005-2003
Hyundai	Prelude	1996-1990
	Elantra	2012-2007
Isuzu	Oasis	1999-1996
Jeep	Compass	2017-2007
	Patriot	2017-2007
Kia	Soul	2011-2010
	Spectra	2009-2008
	Spectra5	2009-2008
Mazda	626	2002-1993
	929	1991-1990
	B2600	1993-1990
	Millenia	2002-1995
	MPV	1995-1990
	MX-6	1997-1993
Mitsubishi	Protege	2003-1999
	Raider	2007-2006
Nissan	240SX	1990
	Axxess	1995-1990
	D21	1994-1990
	Pickup	1997-1995
	Stanza	1992-1990
Saturn	Astra	2009-2008
2526	BKR5EYA-11	V-Power
Qty per Vehicle: 4-6		Box Qty: 4
Ford	Taurus	1995-1989
Geo	Prizm	1989
Lexus	GS300	2000-1994
	SC300	1992
	SC300	2000-1994
Scion	xB	2015-2014
Toyota	4Runner	2000
	Celica	1990
	Celica	2005-2004
	Matrix	2004
	MR2	1991
	Paseo	1995-1992



2526 (Cont'd)		BKR5EYA-11	V-Power	2635 (Cont'd)		GR4	V-Power	
Qty per Vehicle: 4-6			Box Qty: 4	Qty per Vehicle: 1-8			Box Qty: 4	
Toyota	Previa		1995-1991	Chevrolet	P10 Van		1969-1968	
	Supra		1997-1993		P20 Series		1966-1963	
	Tacoma		2004-2000		P30 Series		1966-1963	
	Yaris		2010		Suburban		1966-1963	
	Yaris		2017-2015	Chrysler	300		1958-1955	
<b>2635</b>			<b>GR4</b>			<b>V-Power</b>		
Qty per Vehicle: 1-8			Box Qty: 4		Cordoba		1983-1975	
American Motors	Ambassador		1974-1965		Daytona		1993-1984	
	American		1968-1964		Dynasty		1993-1988	
	AMX		1970-1968		E Class		1984-1983	
	AMX		1979-1978		Fifth Avenue		1989-1983	
	Classic		1966-1964		Imperial		1958-1957	
	Concord		1979-1978		Imperial		1982-1981	
	Gremlin		1977-1970		Laser		1986-1984	
	Hornet		1977-1970		LeBaron		1994-1977	
	Javelin		1974-1968		Nassau		1955	
	Marlin		1967-1965		Newport		1958-1955	
	Matador		1978-1971		Newport		1972-1971	
	Pacer		1979-1975		Newport		1981-1974	
	Rambler		1969		New Yorker		1958-1956	
	Rebel		1970-1967		New Yorker		1988-1977	
	Spirit		1979		St Regis		1956	
Bentley	Corniche		1980-1971		TC Maserati		1989	
	Corniche		1983-1982		Town & Country		1958-1955	
	Mulsanne		1983-1981		Town & Country		1988-1978	
	T1 Series		1976-1968		Windsor		1956-1955	
	T2 Series		1980-1977		Dodge	330		1964
Buick	Skylark		1969-1968	400			1983-1982	
	Special		1969-1968	600			1988-1983	
Cadillac	Calais		1974-1968	A100			1966-1964	
	DeVille		1974-1968	A100			1970	
	Eldorado		1974-1968	A100 Truck			1970-1964	
Checker	Fleetwood		1974-1968	A108 Van			1970-1967	
	Marathon		1969-1968	Aries			1989-1981	
Chevrolet	Bel Air		1961-1958	Aspen			1980-1976	
	Bel Air		1969-1963	B100			1980-1975	
	Biscayne		1961-1958	B100 Van			1974-1971	
	Biscayne		1969-1963	B150			1991-1981	
	Blazer		1969	B200			1980-1975	
	Brookwood		1969	B200 Van			1974-1971	
	C10 Pickup		1969-1963	B250			1992-1981	
	C10 Suburban		1969-1968	B300			1980-1975	
	C20 Pickup		1969-1963	B300 Van			1974-1971	
	C20 Suburban		1969-1968	B350			1992-1981	
	C30 Pickup		1969-1964	Caravan			1995-1984	
	Camaro		1969-1967	CB300			1980-1974	
	Caprice		1969-1967	Challenger			1974-1970	
	Chevle		1969-1964	Charger			1978-1967	
	Chevy II		1968-1962	Charger			1987-1983	
	El Camino		1960-1959	Coronet		1958-1957		
	El Camino		1969-1964	Coronet		1976-1965		
	G10 Van		1969-1964	Custom		1958-1957		
	G20 Van		1969-1967	D100		1979-1975		
	Impala		1961-1959	D100		1989-1984		
	Impala		1969-1963	D100 Pickup		1974-1968		
	K10 Pickup		1969-1964	D100 Series		1967-1961		
	K10 Suburban		1969-1967	D150		1991-1977		
	K20 Pickup		1969-1964	D200		1980-1975		
	K20 Suburban		1969-1968	D200 Pickup		1974-1968		
	K30 Pickup		1969-1968	D200 Series		1967-1961		
	LUV		1982-1975	D250		1992-1981		
	Luv Pickup		1974-1972	D300		1980-1975		
	Malibu		1967-1964	D300 Pickup		1974-1968		
	Nova		1970	D300 Series		1967-1961		
P10 Series		1967-1963	D350		1992-1981			
			D400		1981-1978			





2635 (Cont'd)	GR4	V-Power	2635 (Cont'd)	GR4	V-Power	
Qty per Vehicle: 1-8		Box Qty: 4	Qty per Vehicle: 1-8		Box Qty: 4	
Dodge	D450	1981-1978	International	1010	1971	
	Dakota	1995-1987		1100D	1970-1969	
	Dart	1976-1960		1110	1971	
	Daytona	1993-1984		1200D	1970-1969	
	Diplomat	1989-1977		1210	1971	
	Dynasty	1993-1988		1300D	1970-1969	
	Grand Caravan	1989-1987		1310	1971	
	Lancer	1962-1961		M800	1971-1969	
	Lancer	1989-1985		M800 Navy	1969	
	Magnum	1979-1978		M800 Post Office	1971-1969	
	Mini Ram	1988-1984		M1100	1971-1969	
	Mirada	1983-1980		M1200	1971-1969	
	Monaco	1978-1968		M1400	1969	
	Omni	1990-1978		MA1200	1971-1969	
	P100	1966-1965		Scout	1970-1969	
	P100	1968		Scout II	1971	
	P200	1966-1965		Jeep	Cherokee	1983-1974
	P200	1972-1968			CJ5	1981-1972
	P300	1972-1968			CJ6	1975-1972
	Polara	1964-1963			CJ7	1981-1976
	Polara	1973-1966			Commando	1973-1972
	Ramcharger	1992-1974	DJ5		1974-1972	
	Rampage	1984-1982	Gladiator		1967-1965	
	RD200	1980-1978	Grand Wagoneer		1991-1984	
	Royal Monaco	1977-1975	J10		1988-1974	
	Shadow	1994-1987	J20		1988-1974	
	Spirit	1995-1989	J-100		1971-1965	
	St. Regis	1981-1979	J-2500		1973-1968	
	W100	1977-1975	J-2600		1970-1968	
	W100	1989-1984	J-2600		1973-1972	
	W100 Pickup	1974-1968	J-2700		1969-1968	
	W100 Series	1967-1961	J-3500		1970-1968	
	W150	1991-1977	J-3600		1970-1968	
	W200	1980-1975	J-3700	1970-1968		
	W200 Pickup	1974-1969	J-3800	1968		
	W200 Series	1967-1961	Wagoneer	1983-1971		
	W250	1992-1981	Mercury	Bobcat	1976-1975	
	W300	1980-1975		Capri	1974-1971	
	W300 Pickup	1974-1968		Capri	1976	
	W300 Series	1967-1963		Tracer	1990-1987	
	W350	1992-1981	Oldsmobile	Cutlass	1969-1968	
GMC	1000 Series	1965-1964		F85	1969-1966	
	1500 Series	1965-1964		Firenza	1986-1982	
	C15/C1500 Pickup	1969-1967	Plymouth	Acclaim	1995-1989	
	C15/C1500 Suburban	1969-1968		Barracuda	1974-1964	
	C25/C2500 Pickup	1969-1967		Belvedere	1970-1963	
	C25/C2500 Suburban	1969-1968		Caravelle	1989-1978	
	C35/C3500 Pickup	1969-1967		Cuda	1974-1971	
	G15/G1500 Van	1969-1967		Custom	1958	
	G25/G2500 Van	1969-1967		Duster	1976-1970	
	G1000 Series	1966-1964		Expo	1989-1987	
	K15/K1500 Pickup	1969-1967		Fleet Special	1963-1960	
	K15/K1500 Suburban	1969-1968		Fury	1965	
	K25/K2500 Pickup	1969-1967		Fury	1978-1968	
	K25/K2500 Suburban	1969-1968		Fury I	1974-1968	
	K35/K3500 Pickup	1969-1968		Fury II	1974-1968	
	P15/P1500 Van	1969-1967		Fury III	1974-1968	
	P25/P2500 Van	1967		Grand Voyager	1988-1987	
	P35/P3500 Van	1967		Gran Fury	1977-1972	
	PB15 Series	1966		Gran Fury	1989-1980	
	PB25 Series	1966	GTX	1971-1967		
	PB1000 Series	1965-1963	Horizon	1990-1978		
PB2500 Series	1963	PB100	1980-1975			
Suburban	1966-1963	PB100 Van	1974			
International	1000D	1970-1969	PB150	1981		



2635 (Cont'd)		GR4	V-Power	2647 (Cont'd)		PFR5G-11	Laser Platinum		
Qty per Vehicle: 1-8			Box Qty: 4	Qty per Vehicle: 4-8			Box Qty: 4		
Plymouth	PB150		1983	Honda	Passport		2002-1997		
	PB200		1980-1975	Hyundai	Azera		2011-2006		
	PB200 Van		1974		Elantra		2003		
	PB250		1983-1981		Entourage		2010-2007		
	PB300		1980-1975		Santa Fe		2009-2007		
	PB300 Van		1974		Sonata		2010-2006		
	PB350		1983-1981		Tiburon		2008		
	Reliant		1989-1981		Tucson		2009-2005		
	Road Runner		1975-1968		Veracruz		2012-2007		
	Satellite		1969-1965		Infiniti	G20		2002-1999	
	Satellite		1974-1971			I30		2001-1996	
	Savoy		1964			J30		1997-1993	
	Scamp		1976-1971		Isuzu	Q45		2001-1994	
	Scamp		1983			Amigo		2000-1998	
	Sundance		1994-1987	Axiom			2003-2002		
	Trailduster		1981-1974	Rodeo			2004-1996		
	Turismo		1985	Rodeo Sport			2003-2001		
	Valiant		1976-1964	Trooper			2002-1996		
	Volare		1980-1976	VehiCROSS			2001-1999		
	Voyager		1995-1984	Jaguar	S-Type		2008-2003		
Pontiac	Firebird		1969-1967		Super V8		2009-2005		
	LeMans		1965-1964		Vanden Plas		2002-2000		
	LeMans		1969-1967		Vanden Plas		2009-2004		
	LeMans		1990-1989		XF		2010-2009		
	Optima		1990-1988		XJ8		2002-2000		
	Sunbird		1991-1989		XJ8		2009-2004		
	Tempest		1965-1964		XJR		2009-2004		
	Tempest		1969-1967		XK		2009-2007		
Rolls-Royce	Camargue		1987-1975		XK8		2006-2000		
	Corniche		1983-1971		XKR		2002-2000		
	Phantom		1967-1960	XKR		2009-2004			
	Silver Cloud		1965-1955	Kia	Sedona		2012-2006		
	Silver Shadow		1976-1966		Sedona		2014		
	Silver Shadow II		1980-1977		Sorento		2009-2007		
	Silver Spirit		1986-1981		Sportage		2010-2005		
	Silver Spur		1986-1981	Land Rover	LR3		2009-2005		
Silver Wraith		1958-1955	Range Rover			2009-2006			
Silver Wraith II		1980-1977	Range Rover Sport			2009-2006			
<b>2641</b>	<b>DCPR9E</b>		<b>Standard</b>	Lincoln	LS		2002-2000		
Qty per Vehicle: 12			Box Qty: 10	Mazda	2		2014-2011		
Ferrari	456 GT		1998-1995		323		1991-1990		
	456 GTA		1998-1997		626		2002-1993		
	456 M		2001-1999		929		1995-1992		
	456 M GT		2004-2002		Miata		1997-1994		
	456 M GTA		2004-2002		Miata		2003-1999		
	512 M		1995		MPV		1998-1996		
	512 TR		1994-1992		MX-3		1996-1992		
	550 Maranello		2002-1997		MX-6		1997-1993		
	575 M Maranello		2005-2002		Protege		2003-1995		
	612 Scaglietti		2010-2005		Protege5		2003-2002		
Superamerica		2005	Mercury		Villager		2002-1999		
Mitsubishi	Eclipse	Galant			Montero Sport		2003		
			Nissan					Altima	
				Frontier					2004-2001
Maxima		2001-1995							
Quest		2002-2001							
Plymouth	Colt	1994-1993							
			Pontiac	Vibe		2008-2003			
							Scion	xB	
Suzuki	Aerio		2007-2003						



2647 (Cont'd)	PFR5G-11	Laser Platinum
Qty per Vehicle: 4-8		Box Qty: 4
Suzuki	Grand Vitara	2005-2003
	SX4	2009-2007
	Vitara	2004-2003
	XL-7	2003
Toyota	Celica	2003
	Corolla	2008-2003
	Corolla	2012
	Matrix	2003
	Matrix	2008-2005
	Matrix	2013-2012
	MR2 Spyder	2005-2003
	Prius	2009-2003
	Tacoma	2004-2003
	Yaris	2009-2006
Yaris	2014-2011	

2667	BKR7EIX	Iridium IX
Qty per Vehicle: 4-10		Box Qty: 4
Audi	200 Quattro	1991
	A3	2013-2006
	A3 Quattro	2013-2009
	A4	2016-2005
	A4 allroad	2016-2013
	A4 Quattro	2016-2005
	A5	2014-2010
	A5 Quattro	2017-2010
	A6	2015-2012
	A6 Quattro	2015-2013
	allroad	2015-2013
	Q3	2017-2015
	Q3 Quattro	2017-2015
	Q5	2017-2011
	R8	2012-2011
	R8	2015-2014
	R8	2017
	RS5	2015-2013
	RS6	2004-2003
	S4	1994-1992
	S6	1997-1995
	TT	2009-2008
	TT Quattro	2015-2009
	BMW	Alpina B7
Porsche	911	2008-2003
	Boxster	2008-2005
	Cayenne	2006-2003
	Cayman	2008-2006
Volkswagen	Beetle	2013-2012
	CC	2017-2009
	Eos	2016-2007
	Golf	2013
	GTI	2014-2006
	Jetta	2010-2006
	Jetta	2013-2012
	Passat	2010-2006
	Passat CC	2010-2009
	Tiguan	2017-2009

2683	TR55-1	V-Power
Qty per Vehicle: 4-8		Box Qty: 4
Buick	Century	1995-1994
Chevrolet	Beretta	1996-1994
	Cavalier	1997-1994
	Corsica	1996-1994
	LLV	1995-1994
	S10	1997-1994
Ford	Country Squire	1991-1987

2683 (Cont'd)	TR55-1	V-Power
Qty per Vehicle: 4-8		Box Qty: 4
Ford	E-150 Econoline	2002-1998
	E-150 Econoline Club Wagon	2002-1998
	E-250 Econoline	2002-1998
	Escort	2002-1991
	Explorer	2010-2006
	Explorer Sport Trac	2010-2007
	F-150	2002-1998
	Focus	2004-2000
	Freestar	2007-2006
	LTD	1986-1985
	LTD Crown Victoria	1991-1987
	Mustang	1986-1985
	Mustang	1997-1994
	Mustang	2010-2005
	Ranger	2011-2001
	Taurus	1995-1988
	Thunderbird	1997-1985
	Windstar	1995
	GMC	Sonoma
Isuzu	Hombre	1997-1996
Land Rover	LR3	2009-2005
Lincoln	Continental	1994-1986
	Mark VII	1987-1985
	Town Car	1990-1986
Mazda	B4000	2002-2001
	B4000	2010-2004
Mercury	Capri	1986-1984
	Colony Park	1991-1987
	Cougar	1997-1985
	Grand Marquis	1991-1986
	Marquis	1986-1983
	Monterey	2007-2004
	Mountaineer	2010-2007
	Sable	1995-1988
Tracer	1999-1991	
Oldsmobile	Cutlass Ciera	1996-1994
Pontiac	Sunfire	1997-1995

2685	FR4GP	G-Power
Qty per Vehicle: 4-8		Box Qty: 4
Buick	Skylark	1994-1988
Chevrolet	Beretta	1991-1990
	Camaro	1992-1987
	Corvette	1991-1986
Dodge	B150	1994-1992
	B250	1994-1992
	B350	1994-1992
	B1500	1996-1995
	B2500	1997-1995
	B3500	1997-1995
	D150	1993-1992
	D250	1993-1992
	D350	1993
	Dakota	1996-1992
	Ram 1500	1997-1994
	Ram 2500	1997-1994
	Ram 3500	1997
	Ramcharger	1993-1992
W150	1993-1992	
W250	1993-1992	
W350	1993	
Ford	F-100	1982
	Granada	1982
	Thunderbird	1982
Jeep	Grand Cherokee	1996-1993
	Grand Wagoneer	1993



2685 (Cont'd)		FR4GP	G-Power	2756 (Cont'd)		BKR6E-11	V-Power
Qty per Vehicle: 4-8		Box Qty: 4		Qty per Vehicle: 4-24		Box Qty: 4	
Lincoln	Continental	1982		Honda	Civic del Sol	1997-1994	
Mercury	Cougar	1982			Passport	1996-1994	
Oldsmobile	Achieva	1994-1992		Infiniti	G20	1996-1991	
	Calais	1987			M30	1992-1990	
	Cutlass Calais	1991-1988		Isuzu	I-Mark	1989	
	Cutlass Supreme	1991-1990			Impulse	1992-1990	
Pontiac	Firebird	1987			Rodeo	1995-1993	
	Grand Am	1994-1988			Rodeo	2003	
	Grand Prix	1991-1990			Rodeo Sport	2003	
<b>2687</b>		<b>FR6EI</b>	<b>Laser Iridium</b>		Stylus	1992-1991	
Qty per Vehicle: 4-6		Box Qty: 4			Trooper	1995-1992	
Mitsubishi	Eclipse	2005-2004		Jaguar	Vanden Plas	2003	
	Endeavor	2008-2004			XJR	2003-1998	
	Endeavor	2011-2010			XKR	2003	
	Galant	2007-2004		Kia	Rio	2005-2003	
	Galant	2009			Sportage	2002-1995	
	Lancer	2010-2008		Land Rover	Discovery	2004-1999	
<b>2743</b>		<b>PFR6J-11</b>	<b>Laser Platinum</b>		Freelander	2005-2002	
Qty per Vehicle: 4-6		Box Qty: 4		Lexus	ES300	2003-1994	
Chrysler	Sebring	1999-1995			ES330	2006-2004	
Dodge	Avenger	1999-1995			GS300	1993	
	Colt	1994-1993			GS300	2005-2001	
	Stealth	1996-1991			GS400	2000-1998	
	Stratus	2005-2001			GS430	2007-2001	
	Eagle	Talon	1998-1995			GX470	2009-2003
Mitsubishi	3000GT	1999-1991			HS250h	2012-2010	
	Diamante	1995-1992			IS300	2005-2001	
	Eclipse	1999			LS400	2000-1990	
	Montero	1996-1995			LS430	2006-2001	
	Montero Sport	1998-1997			LX470	2007-1998	
Plymouth	Colt	1994-1993			RX300	2003-1999	
Suzuki	Esteem	2002-2001			RX330	2006-2004	
	Grand Vitara	2008-2006			RX400h	2008-2006	
	XL-7	2006-2004			SC300	1994-1993	
<b>2756</b>		<b>BKR6E-11</b>	<b>V-Power</b>		SC400	2000-1992	
Qty per Vehicle: 4-24		Box Qty: 4			SC430	2010-2002	
Acura	Integra	2001-1992		Lotus	Elan	1991	
	Legend	1995-1991			Elise	2007-2005	
	NSX	2005-1991			Exige	2006	
Aston Martin	DB9	2005		Mazda	Miata	1993-1990	
Audi	A6 Quattro	2006-2005			Protege	1994-1990	
Chevrolet	Aveo	2008-2004		Mercedes-Benz	C32 AMG	2004-2002	
	Aveo5	2008-2006			C55 AMG	2006-2005	
	Epica	2006-2004			C230	2002	
	Metro	2001-1998			CL600	2002	
	Tracker	1991-1990			CLK55 AMG	2006-2003	
	Tracker	2002-1998			S600	2002	
					SLK32 AMG	2004-2002	
Chrysler	Crossfire	2006-2005		SLK55 AMG	2011-2005		
	Sebring	1999-1995		SLK230	2004-2001		
	Sebring	2005-2001		Mercury	Capri	1994-1991	
Daewoo	Lanos	2002-1999			Tracer	1996-1991	
	Nubira	2002-1999		Mini	Cooper	2008-2007	
Daihatsu	Charade	1992-1989		Mitsubishi	3000GT	1999-1991	
	Rocky	1992-1990			Diamante	1995-1992	
Dodge	Avenger	1999-1995			Eclipse	2000-1999	
	Colt	1994-1993			Galant	2000-1999	
	Stealth	1996-1991			Montero	1996-1995	
	Stratus	2005-2001			Montero Sport	1998-1997	
	Eagle	Talon	1998-1995		Nissan	200SX	1998-1995
Ford	Escort	1996-1991			Frontier	2004-2001	
	Probe	1997-1993			Maxima	1994-1989	
Geo	Storm	1991-1990			NX	1993-1991	
GMC	Tracker	1991-1989			Sentra	1994-1991	
Honda	Civic	2000-1999			Sentra	1999-1998	



2756 (Cont'd)	BKR6E-11	V-Power	2763 (Cont'd)	GR4GP	G-Power
Qty per Vehicle: 4-24		Box Qty: 4	Qty per Vehicle: 1-8		Box Qty: 4
Nissan	Xterra	2004-2002	American Motors	Matador	1978-1971
Plymouth	Colt	1994-1993		Pacer	1979-1975
Pontiac	Vibe	2006-2003		Rambler	1969
	Vibe	2010-2009		Rebel	1970-1967
	Wave	2008-2005	Spirit	1979	
	Wave5	2007-2005	Bentley	Corniche	1980-1971
Scion	tC	2010-2005		Corniche	1983-1982
	xB	2012-2008		Mulsanne	1983-1981
Subaru	Baja	2003		T1 Series	1976-1968
	Forester	2004-1999		T2 Series	1980-1977
	Impreza	2004-1993		Buick	Skylark
	Legacy	2003-1990	Special		1969-1968
	Outback	2003-2000	Cadillac	Calais	1974-1968
	Outback	2012-2010		DeVille	1974-1968
SVX	1997-1992	Eldorado		1974-1968	
Suzuki	Esteem	2002-1999		Fleetwood	1974-1968
	Grand Vitara	1999	Checker	Marathon	1969-1968
	Grand Vitara	2008-2006	Chevrolet	Bel Air	1961-1958
	Swift	2001-1995		Bel Air	1969-1963
	Swift+	2008-2004		Biscayne	1961-1958
	Verona	2006-2005		Biscayne	1969-1963
	Vitara	2002-1999		Blazer	1969
	XL-7	2006-2004		Brookwood	1969
Toyota	4Runner	2009-2003		C10 Pickup	1969-1963
	Avalon	1995		C10 Suburban	1969-1968
	Avalon	2004-2000		C20 Pickup	1969-1963
	Camry	1996-1992		C20 Suburban	1969-1968
	Camry	2011-2002	C30 Pickup	1969-1964	
	Celica	2005-1991	Camaro	1969-1967	
	Corolla	2006-2005	Caprice	1969-1967	
	Corolla	2012-2009	Chevelle	1969-1964	
	Highlander	2010-2001	Chevy II	1968-1962	
	Land Cruiser	2007-1998	El Camino	1960-1959	
	Matrix	2006-2003	El Camino	1969-1964	
	Matrix	2012-2009	G10 Van	1969-1964	
	MR2	1995-1992	G20 Van	1969-1967	
	Previa	1997-1995	Impala	1961-1959	
	RAV4	1996	Impala	1969-1963	
	RAV4	2008-2001	K10 Pickup	1969-1964	
	Sequoia	2009-2005	K10 Suburban	1969-1967	
	Sienna	2006-2001	K20 Pickup	1969-1964	
	Solara	2008-2002	K20 Suburban	1969-1968	
	Supra	1998-1993	K30 Pickup	1969-1968	
Tundra	2009-2005	LUV	1982-1975		
<b>2761</b>	<b>PFR5G-13E</b>	<b>Laser Platinum</b>	Luv Pickup	1974-1972	
Qty per Vehicle: 6-8		Box Qty: 4	Malibu	1967-1964	
Jaguar	S-Type	2002-2000	Nova	1970	
	Vanden Plas	1999-1997	P10 Series	1967-1963	
	Vanden Plas	2003	P10 Van	1969-1968	
	XJ8	1999-1998	P20 Series	1966-1963	
	XJ8	2003	P30 Series	1966-1963	
	XK8	1999-1997	Suburban	1966-1963	
<b>2763</b>	<b>GR4GP</b>	<b>G-Power</b>	Chrysler	300	1958-1955
Qty per Vehicle: 1-8		Box Qty: 4		Cordoba	1983-1975
American Motors	Ambassador	1974-1965		Daytona	1993-1984
	American	1968-1964		Dynasty	1993-1988
	AMX	1970-1968		E Class	1984-1983
	AMX	1979-1978		Fifth Avenue	1989-1983
	Classic	1966-1964		Imperial	1958-1957
	Concord	1979-1978		Imperial	1982-1981
	Gremlin	1977-1970		Laser	1986-1984
	Hornet	1977-1970		LeBaron	1994-1977
	Javelin	1974-1968		Nassau	1955
	Marlin	1967-1965		Newport	1958-1955
				Newport	1972-1971





2763 (Cont'd)		GR4GP	G-Power	2763 (Cont'd)		GR4GP	G-Power
Qty per Vehicle: 1-8			Box Qty: 4	Qty per Vehicle: 1-8			Box Qty: 4
Chrysler	Newport		1981-1974	Dodge	P200		1972-1968
	New Yorker		1958-1956		P300		1972-1968
	New Yorker		1988-1977		Polara		1964-1963
	St Regis		1956		Polara		1973-1966
	TC Maserati		1989		Ramcharger		1992-1974
	Town & Country		1958-1955		Rampage		1984-1982
	Town & Country		1988-1978		RD200		1980-1978
	Windsor		1956-1955		Royal Monaco		1977-1975
Dodge	330		1964		Shadow		1994-1987
	400		1983-1982		Spirit		1995-1989
	600		1988-1983		St. Regis		1981-1979
	A100		1966-1964		W100		1977-1975
	A100		1970		W100		1989-1984
	A100 Truck		1970-1964		W100 Pickup		1974-1968
	A108 Van		1970-1967		W100 Series		1967-1961
	Aries		1989-1981		W150		1991-1977
	Aspen		1980-1976		W200		1980-1975
	B100		1980-1975		W200 Pickup		1974-1969
	B100 Van		1974-1971		W200 Series		1967-1961
	B150		1991-1981		W250		1992-1981
	B200		1980-1975		W300		1980-1975
	B200 Van		1974-1971		W300 Pickup		1974-1968
	B250		1992-1981	W300 Series		1967-1963	
	B300		1980-1975	W350		1992-1981	
	B300 Van		1974-1971	GMC	1000 Series		1965-1964
	B350		1992-1981		1500 Series		1965-1964
	Caravan		1995-1984		C15/C1500 Pickup		1969-1967
	CB300		1980-1974		C15/C1500 Suburban		1969-1968
	Challenger		1974-1970		C25/C2500 Pickup		1969-1967
	Charger		1978-1967		C25/C2500 Suburban		1969-1968
	Charger		1987-1983		C35/C3500 Pickup		1969-1967
	Coronet		1958-1957		G15/G1500 Van		1969-1967
	Coronet		1976-1965		G25/G2500 Van		1969-1967
	Custom		1958-1957		G1000 Series		1966-1964
	D100		1979-1975		K15/K1500 Pickup		1969-1967
	D100		1989-1984		K15/K1500 Suburban		1969-1968
	D100 Pickup		1974-1968		K25/K2500 Pickup		1969-1967
	D100 Series		1967-1961		K25/K2500 Suburban		1969-1968
	D150		1991-1977		K35/K3500 Pickup		1969-1968
	D200		1980-1975		P15/P1500 Van		1969-1967
	D200 Pickup		1974-1968		P25/P2500 Van		1967
	D200 Series		1967-1961		P35/P3500 Van		1967
	D250		1992-1981		PB15 Series		1966
	D300		1980-1975		PB25 Series		1966
	D300 Pickup		1974-1968	PB1000 Series		1965-1963	
	D300 Series		1967-1961	PB2500 Series		1963	
	D350		1992-1981	Suburban		1966-1963	
	D400		1981-1978	International	1000D		1970-1969
	D450		1981-1978		1010		1971
	Dakota		1995-1987		1100D		1970-1969
	Dart		1976-1960		1110		1971
	Daytona		1993-1984		1200D		1970-1969
	Diplomat		1989-1977		1210		1971
	Dynasty		1993-1988		1300D		1970-1969
	Grand Caravan		1989-1987		1310		1971
	Lancer		1962-1961		M800		1971-1969
	Lancer		1989-1985		M800 Navy		1969
	Magnum		1979-1978		M800 Post Office		1971-1969
	Mini Ram		1988-1984		M1100		1971-1969
	Mirada		1983-1980		M1200		1971-1969
	Monaco		1978-1968	M1400		1969	
	Omni		1990-1978	MA1200		1971-1969	
P100		1966-1965	Scout		1970-1969		
P100		1968	Scout II		1971		
P200		1966-1965	Jeep	Cherokee		1983-1974	



2763 (Cont'd)		GR4GP	G-Power	2763 (Cont'd)		GR4GP	G-Power	
Qty per Vehicle: 1-8			Box Qty: 4	Qty per Vehicle: 1-8			Box Qty: 4	
Jeep	CJ5		1981-1972	Plymouth	Valiant		1976-1964	
	CJ6		1975-1972		Volare		1980-1976	
	CJ7		1981-1976		Voyager		1995-1984	
	Commando		1973-1972		Pontiac	Firebird		1969-1967
	DJ5		1974-1972			LeMans		1965-1964
	Gladiator		1967-1965	LeMans			1969-1967	
	Grand Wagoneer		1991-1984	LeMans			1990-1989	
	J10		1988-1974	Optima			1990-1988	
	J20		1988-1974	Sunbird			1991-1989	
	J-100		1971-1965	Tempest			1965-1964	
	J-2500		1973-1968	Tempest		1969-1967		
	J-2600		1970-1968	Rolls-Royce	Camargue		1987-1975	
	J-2600		1973-1972		Corniche		1983-1971	
	J-2700		1969-1968		Phantom		1967-1960	
	J-3500		1970-1968		Silver Cloud		1965-1955	
	J-3600		1970-1968		Silver Shadow		1976-1966	
	J-3700		1970-1968		Silver Shadow II		1980-1977	
	J-3800		1968		Silver Spirit		1986-1981	
Wagoneer		1983-1971	Silver Spur			1986-1981		
Mercury	Bobcat		1976-1975		Silver Wraith		1958-1955	
	Capri		1974-1971		Silver Wraith II		1980-1977	
	Capri		1976					
	Tracer		1990-1987					
Oldsmobile	Cutlass		1969-1968	<b>2771 UR5</b>		<b>V-Power</b>		
	F85		1969-1966	Qty per Vehicle: 4-8		Box Qty: 4		
	Firenza		1986-1982	AM General	Hummer		1996-1995	
Plymouth	Acclaim		1995-1989	Buick	Century		1986-1983	
	Barracuda		1974-1964	Commercial Chassis			1993-1992	
	Belvedere		1970-1963	Roadmaster			1993-1992	
	Caravelle		1989-1978	Skyhawk			1986-1982	
	Cuda		1974-1971	Skylark			1985-1980	
	Custom		1958	Cadillac	Brougham		1992-1990	
	Duster		1976-1970		Cimarron		1986-1982	
	Expo		1989-1987		Commercial Chassis		1992	
	Fleet Special		1963-1960	Chevrolet	Astro		1995-1985	
	Fury		1965		Bel Air		1971	
	Fury		1978-1968		Biscayne		1971	
	Fury I		1974-1968		Blazer		1995-1987	
	Fury II		1974-1968		C10		1986-1984	
	Fury III		1974-1968		C10 Suburban		1986-1984	
	Grand Voyager		1988-1987		C20		1986-1985	
	Gran Fury		1977-1972		C20 Suburban		1986-1984	
	Gran Fury		1989-1980		C1500		1995-1988	
	GTX		1971-1967		C1500 Suburban		1995-1992	
	Horizon		1990-1978		C2500		1995-1988	
	PB100		1980-1975		C2500 Suburban		1995-1992	
	PB100 Van		1974		C3500		1995-1988	
	PB150		1981		C3500HD		1995-1991	
	PB150		1983		Camaro		1995-1982	
	PB200		1980-1975		Caprice		1971	
	PB200 Van		1974		Caprice		1993-1989	
	PB250		1983-1981		Cavalier		1986-1982	
	PB300		1980-1975		Celebrity		1986-1982	
	PB300 Van		1974		Chevette		1987-1976	
	PB350		1983-1981	Citation		1983-1980		
	Reliant		1989-1981	Citation II		1985-1984		
	Road Runner		1975-1968	Corvette		1971		
	Satellite		1969-1965	Corvette		1987-1985		
	Satellite		1974-1971	El Camino		1971		
	Savoy		1964	El Camino		1986		
	Scamp		1976-1971	G10		1995-1984		
	Scamp		1983	G20		1995-1984		
	Sundance		1994-1987	G30		1996-1984		
	Trailduster		1981-1974	K5 Blazer		1986-1984		
Turismo		1985	K10		1986-1985			
			K10 Suburban		1986-1984			
			K20		1986-1985			



2771 (Cont'd)	UR5	V-Power	2771 (Cont'd)	UR5	V-Power	
Qty per Vehicle: 4-8		Box Qty: 4	Qty per Vehicle: 4-8		Box Qty: 4	
Chevrolet	K20 Suburban	1986-1984	Ford	F-250	1996-1980	
	K30	1985		F-250 HD	1997	
	K1500	1995-1988		F-350	1975	
	K1500 Suburban	1995-1992		F-350	1980	
	K2500	1995-1988		F-350	1997-1984	
	K2500 Suburban	1995-1992		Falcon	1970	
	K3500	1995-1988		F Super Duty	1997	
	Lumina APV	1995-1990		Mustang	1983	
	Monte Carlo	1971		Thunderbird	1983	
	Monte Carlo	1986-1985		GMC	C1500	1986-1984
	Monza	1977-1976			C1500	1995-1988
	P20	1989-1987			C1500 Suburban	1986-1984
	P30	1997-1987			C1500 Suburban	1995-1992
	P40	1988	C2500		1986-1985	
	R10	1987	C2500		1995-1988	
	R10 Suburban	1988-1987	C2500 Suburban		1986-1985	
	R20	1988-1987	C2500 Suburban		1995-1992	
	R20 Suburban	1988-1987	C3500		1995-1988	
	R30	1988-1987	C3500HD		1995-1991	
	R1500 Suburban	1991-1989	Caballero		1986	
	R2500	1989	G1500		1995-1984	
	R2500 Suburban	1991-1989	G2500		1995-1984	
	R3500	1991-1989	G3500		1996-1984	
	S10	1995-1982	Jimmy		1995-1984	
	S10 Blazer	1994-1983	K1500		1986-1985	
	Tahoe	1995	K1500		1995-1988	
	V10	1987	K1500 Suburban		1986-1984	
	V10 Suburban	1988-1987	K1500 Suburban		1995-1992	
	V20	1987	K2500		1986-1985	
	V20 Suburban	1988-1987	K2500	1995-1988		
	V30	1988-1987	K2500 Suburban	1995-1992		
	V1500 Suburban	1991-1989	K3500	1995-1988		
	V2500 Suburban	1991-1989	P25	1976		
V3500	1991-1989	P35	1976			
Vega	1974-1971	P2500	1989-1988			
Vega	1977-1976	P3500	1997-1987			
Dodge	M300	1974	R1500	1987		
	M350	1974	R1500 Suburban	1991-1987		
Ford	B600	1989-1986	R2500	1989-1987		
	B700	1989-1986	R2500 Suburban	1991-1987		
	Bronco	1975	R3500	1991-1987		
	Bronco	1996-1980	S15	1990-1982		
	C600	1986	S15 Jimmy	1991-1983		
	C700	1986	Safari	1995-1985		
	C800	1986	Sonoma	1995-1991		
	E-100 Econoline	1975	Sprint	1971		
	E-100 Econoline	1982-1980	Syclone	1991		
	E-100 Econoline Club Wagon	1982-1980	Typhoon	1993-1992		
	E-150 Econoline	1975	V1500	1987		
	E-150 Econoline	1996-1980	V1500 Suburban	1991-1987		
	E-150 Econoline Club Wagon	1996-1980	V2500	1987		
	E-250 Econoline	1975	V2500 Suburban	1991-1987		
	E-250 Econoline	1996-1980	V3500	1991-1987		
	E-250 Econoline Club Wagon	1980	Yukon	1995-1992		
	E-250 Econoline Club Wagon	1991-1985	Isuzu	Pickup	1994-1991	
	E-350 Econoline	1975		Rodeo	1992-1991	
	E-350 Econoline	1982-1980	Jeep	Trooper	1991-1989	
	E-350 Econoline	1996-1985		Cherokee	1986-1984	
	E-350 Econoline Club Wagon	1996-1985		Comanche	1986	
	Econoline Super Duty	1996	Wagoneer	1986-1984		
	F53	1997	Mercury	Cyclone	1971	
	F-100	1975		Oldsmobile	Bravada	1994-1991
	F-100	1983-1980			Custom Cruiser	1992
	F-150	1975			Cutlass Ciera	1986-1982
	F-150	1996-1980	Firenza		1986-1982	



2771 (Cont'd)	UR5	V-Power
Qty per Vehicle: 4-8		Box Qty: 4
Oldsmobile	Omega	1984-1980
	Silhouette	1994-1990
	Starfire	1977-1976
Pontiac	6000	1986-1982
	Acadian	1987-1976
	Astre	1977-1976
	Bonneville	1986
	Fiero	1988-1985
	Firebird	1995-1982
	Grand Prix	1986
	J2000	1983-1982
	J2000 Sunbird	1985-1984
	Parisienne	1986
	Phoenix	1984-1980
	Sunbird	1977-1976
	Sunbird	1986
	T1000	1987-1981
Trans Sport	1995-1990	

2815	TR4GP	G-Power
Qty per Vehicle: 4-6		Box Qty: 4
Buick	Century	1989-1987
	Century	1993
	Lucerne	2011-2009
	Regal	1993-1988
	Skyhawk	1989-1987
	Terraza	2007-2006
Cadillac	Cimarron	1988-1987
Chevrolet	Beretta	1993-1987
	Cavalier	1994-1987
	Celebrity	1990-1987
	Corsica	1993-1987
	Impala	2011-2006
	Lumina	1994-1990
	Malibu	2010-2006
	Monte Carlo	2007-2006
	Uplander	2009-2006
Oldsmobile	Cutlass Ciera	1989-1987
	Cutlass Ciera	1993
	Cutlass Cruiser	1989-1987
	Cutlass Supreme	1993-1988
	Firenza	1988-1987
Pontiac	6000	1991-1987
	G6	2010-2006
	Grand Prix	1993-1988
	Montana	2009-2006
	Sunbird	1994-1991
	Tempest	1991-1987
Saturn	Aura	2008-2007
	Relay	2007-2006
	Vue	2010-2008

2851	GR5	V-Power
Qty per Vehicle: 3-8		Box Qty: 4
Buick	Skyhawk	1987-1982
Chevrolet	Bel Air	1969-1961
	Biscayne	1969-1961
	C10 Pickup	1969-1968
	C10 Suburban	1969-1968
	C20 Pickup	1969-1968
	C20 Suburban	1969-1968
	C30 Pickup	1969-1968
	Camaro	1969-1967
	Caprice	1969-1966
	Chevelle	1969-1966
	Chevy II	1968

2851 (Cont'd)	GR5	V-Power	
Qty per Vehicle: 3-8		Box Qty: 4	
Chevrolet	Corvette	1969-1966	
	El Camino	1970-1966	
	Impala	1969-1961	
	K10 Pickup	1969-1968	
	K10 Suburban	1969-1968	
	K20 Pickup	1969-1968	
	K30 Pickup	1969-1968	
	Malibu	1967-1966	
	Nova	1970	
	S10	1985-1982	
	S10 Blazer	1984-1983	
	Spectrum	1988-1985	
	Sprint	1988-1985	
	Dodge	Charger	1967
		Coronet	1971-1967
		Polara	1966
	Ford	Courier	1979-1972
Courier		1981	
Mustang II		1976-1974	
Pinto		1973-1971	
Pinto		1976-1975	
Spectrum		1989	
GMC	C15/C1500 Pickup	1969-1968	
	C15/C1500 Suburban	1968	
	C25/C2500 Pickup	1969-1968	
	C25/C2500 Suburban	1968	
	C35/C3500 Pickup	1969-1968	
	K15/K1500 Pickup	1969-1968	
	K15/K1500 Suburban	1968	
	K25/K2500 Pickup	1969-1968	
	K25/K2500 Suburban	1968	
	K35/K3500 Pickup	1969-1968	
S15	1985-1982		
S15 Jimmy	1984-1983		
International	100	1974	
	200	1974	
	1010	1973-1972	
	1110	1973-1972	
	1210	1973-1972	
	1310	1973-1972	
	M800 Post Office	1972	
	M1100	1972	
	M1200	1972	
	MHC1310	1974	
MS1210	1974-1972		
Plymouth	Belvedere	1966	
	Cuda	1971-1970	
	Fury	1966-1963	
	Satellite	1967-1965	
Pontiac	Firefly	1988-1985	
	Grand Am	1989-1987	
	J2000	1983-1982	
	J2000 Sunbird	1985-1984	
	Sunbird	1990-1986	
	Sunbird	1994-1992	
	Sunburst	1988-1985	

2867	PFR5B-11B	Laser Platinum
Qty per Vehicle: 6		Box Qty: 4
Nissan	300ZX	1996-1990

2869	UR4GP	G-Power
Qty per Vehicle: 4-8		Box Qty: 4
Buick	Apollo	1974-1973
	Centurion	1973-1971
	Century	1974-1973



2869 (Cont'd)		UR4GP	G-Power	2869 (Cont'd)		UR4GP	G-Power
Qty per Vehicle: 4-8			Box Qty: 4	Qty per Vehicle: 4-8			Box Qty: 4
Buick	Century		1981-1977	Chevrolet	K10 Pickup		1971
	Commercial Chassis		1991		K10 Suburban		1971
	Electra		1974-1967		K10 Suburban		1983-1976
	Estate Wagon		1974-1970		K10 Suburban		1986-1985
	Gran Sport		1967		K20		1985-1976
	GS		1972-1970		K20 Pickup		1971
	GS 350		1969-1968		K20 Suburban		1971
	GS 400		1969-1968		K20 Suburban		1986-1976
	GS 455		1972-1970		K30		1980-1977
	LeSabre		1974-1968		K30		1984-1982
	LeSabre		1980-1978		K30 Pickup		1971
	LeSabre		1982		Kingswood		1971-1970
	Regal		1974-1973		Laguna		1976
	Regal		1987-1977		Malibu		1983-1975
	Riviera		1974-1967		Monte Carlo		1971-1970
	Riviera		1981-1979		Monte Carlo		1988-1976
	Riviera		1985-1984		Monza		1979-1976
	Roadmaster		1991		Nova		1971
	Skylark		1972-1967		Nova		1979-1975
	Skylark		1979-1977		P10		1979-1977
Special		1969-1968	P10 Van		1972-1971		
Sportwagon		1972-1968	P20		1976		
Wildcat		1970-1967	P20		1984-1979		
Cadillac	Brougham		1992-1991	P20 Van		1972-1970	
	Commercial Chassis		1993	P30		1976	
	Fleetwood		1993	P30		1984-1978	
Checker	Marathon		1974-1970	P30 Van		1972-1970	
	Marathon		1978-1976	Townsmen		1971-1970	
Chevrolet	Bel Air		1971	Vega		1976	
	Bel Air		1981	Chrysler	Cordoba		1983-1980
	Biscayne		1971		Fifth Avenue		1983
	Blazer		1971		LeBaron		1981-1978
	C10		1986-1976		Newport		1981-1979
	C10 Pickup		1971		New Yorker		1982
	C10 Suburban		1971	Town & Country		1981-1978	
	C10 Suburban		1986-1976	Dodge	Aspen		1980-1976
	C20		1986-1976		B100		1980-1975
	C20 Pickup		1971		B100 Van		1974
	C20 Suburban		1971		B150		1987-1981
	C20 Suburban		1986-1976		B200		1980-1975
	C30		1984-1976		B200 Van		1974
	C30 Pickup		1971		B250		1987-1981
	C70		1990		B300		1980-1975
	Camaro		1971		B300 Van		1974
	Camaro		1992-1975		CB300		1975
	Caprice		1971		CB300		1979-1977
	Caprice		1993-1976		Charger		1976
	Chevelle		1971		Coronet		1976-1975
	Corvette		1971		D100		1979-1975
	Corvette		1982-1976		D100		1987-1984
	Corvette		1984		D150		1987-1977
	Corvette		1991-1988		D200		1980-1975
	El Camino		1971-1970		D250		1987-1981
	El Camino		1985-1976		D300		1978-1975
	El Camino		1987		Dart		1976-1975
	G10		1984-1976		Diplomat		1983-1978
	G10 Van		1971		Mirada		1983-1980
	G20		1984-1976		Monaco		1978-1977
	G20 Van		1971		Ramcharger		1980-1975
	G30		1984-1976		St. Regis		1981-1979
	G30 Van		1971		W100		1977-1975
	Impala		1971		W100		1987-1984
	Impala		1985-1976	W150		1987-1978	
	K5 Blazer		1986-1976	W200		1980-1975	
	K10		1986-1976	W250		1982-1981	





2869 (Cont'd)	UR4GP	G-Power	2869 (Cont'd)	UR4GP	G-Power
Qty per Vehicle: 4-8		Box Qty: 4	Qty per Vehicle: 4-8		Box Qty: 4
Dodge	W300	1978-1975	GMC	G15/G1500 Van	1971
	W350	1982		G25	1978-1976
Ford	Bronco	1988-1976	G25/G2500 Van	1971	
	Country Sedan	1974-1970	G35	1978-1976	
	Country Squire	1974-1970	G35/G3500 Van	1971	
	Custom	1972-1970	G1500	1984-1979	
	Custom 500	1976-1970	G2500	1984-1979	
	E-100 Econoline	1983-1975	G3500	1984-1979	
	E-100 Econoline Club Wagon	1983-1975	Jimmy	1971	
	E-150 Econoline	1988-1975	Jimmy	1983-1976	
	E-150 Econoline Club Wagon	1985-1975	Jimmy	1986-1985	
	E-250 Econoline	1988-1975	K15	1978-1976	
	E-250 Econoline Club Wagon	1991-1975	K15/K1500 Pickup	1971	
	E-350 Econoline	1996-1975	K15/K1500 Suburban	1971	
	E-350 Econoline Club Wagon	1996-1977	K15 Suburban	1978-1976	
	Econoline Super Duty	1996	K25	1978-1976	
	Elite	1976-1975	K25/K2500 Pickup	1971	
	F53	1996-1988	K25/K2500 Suburban	1971	
	F-100	1974-1973	K25 Suburban	1978-1976	
	F-100	1979-1976	K35	1978-1977	
	F-100	1982-1981	K35/K3500 Pickup	1971	
	F-150	1988-1975	K1500	1986-1979	
	F-250	1996-1973	K1500 Suburban	1984-1979	
	F-350	1996-1973	K2500	1985-1979	
	Fairlane	1970-1969	K2500 Suburban	1984-1979	
	Falcon	1970	K3500	1984-1979	
	F Super Duty	1988	P15/P1500 Van	1971	
	F Super Duty	1996-1990	P25	1976	
	Galaxie 500	1974-1969	P25/P2500 Van	1971-1970	
	Granada	1976-1975	P35	1976	
	Gran Torino	1976-1972	P35	1978	
	LTD	1976-1970	P35/P3500 Van	1971-1970	
	LTD	1986-1981	P1500	1979	
	LTD Crown Victoria	1991-1987	P2500	1984-1979	
	Maverick	1976-1975	P3500	1984-1979	
	Mustang	1973-1969	Sprint	1971	
	Mustang	1985-1984	Sprint	1977-1975	
	Mustang II	1976-1975	Jeep	J-100	1971-1969
	P-350	1976	J-2500	1971-1969	
	P-400	1976	J-2600	1970-1969	
	P-500	1977-1976	J-2700	1970-1969	
	Ranchero	1977-1970	J-3500	1970-1969	
Ranch Wagon	1974-1970	J-3600	1970-1969		
Thunderbird	1973-1972	J-3700	1970-1969		
Thunderbird	1976-1975	J-3800	1970-1969		
Torino	1976-1970	Wagoneer	1971		
GMC	C15	1978-1976	Lincoln	Continental	1976-1973
	C15/C1500 Pickup	1971	Mark IV	1976-1973	
	C15/C1500 Suburban	1971	Mercury	Capri	1985-1984
	C15 Suburban	1978-1976	Colony Park	1974-1970	
	C25	1978-1976	Comet	1976-1971	
	C25/C2500 Pickup	1971	Cougar	1978-1969	
	C25/C2500 Suburban	1971	Cyclone	1971-1969	
	C25 Suburban	1978-1976	Grand Marquis	1976-1975	
	C35	1978-1976	Grand Marquis	1978	
	C35/C3500 Pickup	1971	Grand Marquis	1989-1983	
	C1500	1986-1979	Marquis	1976-1971	
	C1500 Suburban	1986-1979	Marquis	1978	
	C2500	1986-1979	Monarch	1977-1975	
	C2500 Suburban	1986-1979	Montego	1976-1970	
	C3500	1980-1979	Monterey	1974-1971	
	C3500	1984-1982	Oldsmobile	Custom Cruiser	1977
	C3500	1986	Custom Cruiser	1992-1991	
	Caballero	1987-1978	Cutlass	1971-1970	
	G15	1978-1976	Cutlass	1976	



2869 (Cont'd)		UR4GP	G-Power	2890 (Cont'd)		BKR5EKUP	Laser Platinum	
Qty per Vehicle: 4-8			Box Qty: 4	Qty per Vehicle: 6			Box Qty: 4	
Oldsmobile	Cutlass		1981-1978	Volkswagen	EuroVan		2001-1999	
	Cutlass		1987-1985		EuroVan		2003	
	Cutlass Calais		1980-1978		Golf		1999-1995	
	Cutlass Calais		1982		Golf		2002-2001	
	Cutlass Cruiser		1980		Jetta		2002-1994	
	Cutlass Cruiser		1982		Passat		1997-1993	
	Cutlass Salon		1980-1978	<b>2950</b>		<b>BCPR5EP-8</b>	<b>Laser Platinum</b>	
	Cutlass Supreme		1976	Qty per Vehicle: 4-6			Box Qty: 4	
	Cutlass Supreme		1980-1978	Geo	Prizm		1992-1990	
	Cutlass Supreme		1982	Saab	900		1994-1992	
	Delta 88		1977	Toyota	4Runner		1988	
	Delta 88		1982-1981		Celica		1993-1988	
	F85		1971-1970		Corolla		1992-1988	
	Omega		1974-1973	<b>2953</b>		<b>YR5GP</b>	<b>G-Power</b>	
	Omega		1979-1976	Qty per Vehicle: 6-8			Box Qty: 4	
	Starfire		1979-1977	Buick	Apollo		1974-1973	
	Plymouth	Caravelle		1983-1978	Chevrolet	Bel Air		1970
		Duster		1976-1974		Bel Air		1974-1972
		Fury		1978-1975		Biscayne		1970
		Gran Fury		1983-1980		Biscayne		1972
PB100			1980-1975	Blazer			1974-1970	
PB100 Van			1974	Brookwood			1972	
PB150			1983-1981	C10			1980-1975	
PB200			1978-1975	C10			1983-1982	
PB200			1980	C10			1986-1985	
PB200 Van			1974	C10 Pickup			1974-1970	
PB250			1983-1981	C10 Suburban			1981-1970	
Scamp			1976-1975	C10 Suburban			1986-1985	
Trailduster			1980-1975	C20			1986-1975	
Valiant			1976-1975	C20 Pickup			1974-1970	
Volare		1980-1976	C20 Suburban			1986-1970		
Pontiac	Bonneville		1974-1972	C30			1986-1975	
	Bonneville		1986-1983	C30 Pickup			1974-1970	
	Catalina		1974-1972	C50			1990-1986	
	Catalina		1981-1977	C70			1990-1986	
	Firebird		1974-1970	Camaro			1970	
	Firebird		1985-1976	Camaro			1974-1972	
	Firebird		1992-1987	Caprice			1970	
	Grand Am		1974-1973	Caprice			1974-1972	
	Grand Am		1980-1978	Chevelle			1973-1970	
	Grand LeMans		1982-1976	Corvette			1970	
	Grand Prix		1974-1972	Corvette			1974-1972	
	Grand Prix		1987-1978	El Camino		1974-1969		
	Grand Safari		1974-1972	El Camino		1979-1976		
	Grandville		1974-1972	G10		1983-1975		
	GTO		1973-1972	G10 Van		1970		
	Laurentian		1981-1976	G10 Van		1974-1972		
	LeMans		1974-1970	G20		1986-1975		
	LeMans		1981-1976	G20 Van		1974-1970		
	Parisienne		1986-1976	G30		1988-1975		
	Phoenix		1979-1977	G30 Van		1974-1971		
	Sunbird		1979-1978	Impala		1970		
	Tempest		1970	Impala		1974-1972		
	Ventura		1974-1971	K5 Blazer		1981-1975		
	Ventura		1977-1976	K10		1986-1975		
	<b>2890</b>		<b>BKR5EKUP</b>	<b>Laser Platinum</b>	K10 Pickup		1974-1970	
	Qty per Vehicle: 6			Box Qty: 4	K10 Suburban		1983-1970	
	Cadillac	Catera		2001-1997	K10 Suburban		1986-1985	
		Saturn	L300	2005-2001	K20		1986-1975	
	Saturn	LS2		2000	K20 Pickup		1974-1970	
		LW2		2000	K20 Suburban		1986-1970	
LW300			2003-2001	K30		1986-1977		
Vue			2003-2002	K30 Pickup		1974-1970		
Volkswagen	Corrado		1995-1992	Kingswood		1972		
	EuroVan		1997					



2953 (Cont'd)	YR5GP	G-Power
Qty per Vehicle: 6-8		Box Qty: 4
Chevrolet	Laguna	1975-1973
	Malibu	1974-1973
	Monte Carlo	1974-1970
	Nova	1970
	Nova	1974-1972
	P10	1980-1975
	P10 Van	1970
	P10 Van	1974-1972
	P20	1989-1975
	P20 Van	1974-1970
	P30	1989-1975
	P30 Van	1974-1970
	R20	1988-1987
	R30	1988-1987
	R3500	1989
	Townsmen	1970
	Townsmen	1972
V20	1987	
V30	1988-1987	
V3500	1989	
GMC	C15	1978-1975
	C15/C1500 Pickup	1974-1970
	C15/C1500 Suburban	1974-1970
	C15 Suburban	1978-1975
	C25	1978-1975
	C25/C2500 Pickup	1974-1970
	C25/C2500 Suburban	1974-1970
	C25 Suburban	1978-1975
	C35	1978-1975
	C35/C3500 Pickup	1974-1970
	C1500	1983-1979
	C1500	1986-1985
	C1500 Suburban	1983-1979
	C1500 Suburban	1986-1985
	C2500	1986-1979
	C2500 Suburban	1986-1979
	C3500	1986-1979
	Caballero	1979-1978
	G15	1978-1975
	G15/G1500 Van	1974-1970
	G25	1978-1975
	G25/G2500 Van	1974-1970
	G35	1978-1975
	G35/G3500 Van	1974-1971
	G1500	1983-1979
	G2500	1983-1979
	G2500	1986-1985
	G3500	1988-1979
	Jimmy	1981-1970
	K15	1978-1975
	K15/K1500 Pickup	1974-1970
	K15/K1500 Suburban	1974-1970
	K15 Suburban	1978-1975
	K25	1978-1975
	K25/K2500 Pickup	1974-1970
	K25/K2500 Suburban	1974-1970
	K25 Suburban	1978-1975
	K35	1978-1977
	K35/K3500 Pickup	1974-1970
	K1500	1985-1979
	K1500 Suburban	1984-1979
	K2500	1986-1979
	K2500 Suburban	1986-1979
	K3500	1986-1979
	P15	1978-1975

2953 (Cont'd)	YR5GP	G-Power
Qty per Vehicle: 6-8		Box Qty: 4
GMC	P15/P1500 Van	1970
	P15/P1500 Van	1974-1972
	P25	1978-1975
	P25/P2500 Van	1974-1970
	P35	1978-1975
	P35/P3500 Van	1974-1970
	P1500	1980-1979
	P2500	1987-1979
	P2500	1989
	P3500	1989-1979
	R2500	1988-1987
R3500	1989-1987	
Sprint	1977-1972	
V2500	1987	
V3500	1989-1987	
Pontiac	Ventura	1972
<b>2978</b>	<b>BKR6EP-11</b>	<b>Laser Platinum</b>
Qty per Vehicle: 4-8		Box Qty: 4
Chevrolet	Aveo	2008-2004
	Aveo5	2008-2006
	Tracker	1991-1989
Daewoo	Nubira	2001-1999
GMC	Tracker	1991-1989
Isuzu	Rodeo	2003
	Rodeo Sport	2003
Lexus	ES300	1995-1994
	ES300	2003-1999
	ES330	2006-2004
	GS300	1993
	GS300	2005-2001
	GS400	2000-1998
	GS430	2007-2001
	GX470	2009-2003
	HS250h	2012-2010
	IS300	2005-2001
	LS400	2000-1990
	LS430	2006-2001
	LX470	2007-1998
	RX300	2003-1999
	RX330	2006-2004
	RX400h	2008-2006
	SC300	1994-1993
SC400	2000-1992	
SC430	2010-2002	
Pontiac	Vibe	2010-2009
	Wave	2008-2005
	Wave5	2007-2005
Scion	tC	2010-2005
	xB	2011-2008
Suzuki	Swift+	2008-2004
Toyota	4Runner	2009-2003
	Avalon	1995
	Avalon	2004-2000
	Camry	1996-1992
	Camry	2011-2002
	Celica	2002-1991
	Celica	2005-2004
	Corolla	2006-2005
	Corolla	2011-2009
	Highlander	2010-2001
	Land Cruiser	2007-1998
	Matrix	2004
	Matrix	2011-2009
	MR2	1995-1992
Previa	1997-1995	



2978 (Cont'd)		BKR6EP-11	Laser Platinum
Qty per Vehicle: 4-8		Box Qty: 4	
Toyota	RAV4	1996	
	RAV4	2008-2001	
	Sequoia	2009-2005	
	Sienna	2006-2001	
	Solara	2008-2002	
	Supra	1998-1993	
	Tundra	2009-2005	
2983		CR6HSA	Standard
Qty per Vehicle: 6		Box Qty: 4	
Aston Martin	DB2	1953-1950	
	DB2-4	1955-1953	
	DB3	1952-1951	
3072		FR45GP	G-Power
Qty per Vehicle: 4-8		Box Qty: 4	
Buick	Electra	1989-1985	
	LeSabre	1990-1985	
	Regal	1987-1986	
	Riviera	1985	
Cadillac	Brougham	1990-1987	
	Fleetwood	1986	
Chevrolet	Caprice	1990-1986	
Chrysler	Cirrus	1997-1995	
	Cirrus	2000-1999	
	Sebring	1998-1996	
	Voyager	2000	
Dodge	Caravan	2000-1996	
	Grand Caravan	1997-1996	
	Stratus	2000-1995	
Oldsmobile	Custom Cruiser	1990-1985	
	Cutlass Salon	1987-1985	
	Cutlass Supreme	1988-1985	
	Delta 88	1985	
	Toronado	1985	
Plymouth	Breeze	2000-1996	
	Grand Voyager	1997-1996	
	Voyager	2000-1996	
Pontiac	Parisienne	1986	
	Safari	1989-1987	
3106		IGR7A-G	Laser Iridium
Qty per Vehicle: 4		Box Qty: 4	
Mitsubishi	Lancer	2005-2003	
3107		IFR5G-11K	Laser Iridium
Qty per Vehicle: 8		Box Qty: 4	
Honda	Civic	2005-2003	
3112		B-4L	Standard
Qty per Vehicle: 6-8		Box Qty: 10	
American Motors	Ambassador	1964	
	American	1962-1958	
	American	1965-1964	
	Classic	1965-1961	
	Custom	1962-1961	
	Deluxe	1962-1961	
	Marlin	1966-1965	
	Rambler	1960-1959	
	Rebel	1959	
	Super Six	1962-1961	
Mercury	Custom	1954	
	Monterey	1954	
3129		BR9EQ-14	Standard
Qty per Vehicle: 4		Box Qty: 4	
Mazda	RX-7	1985-1984	

3141		PFR6L-13	Laser Platinum
Qty per Vehicle: 4		Box Qty: 4	
Honda	Civic	2000-1999	
	Civic del Sol	1997-1994	
3142		GR45GP	G-Power
Qty per Vehicle: 4-8		Box Qty: 4	
Asuna	GT	1993	
	SE	1993	
Buick	Skyhawk	1988-1987	
Cadillac	Calais	1976-1975	
	Commercial Chassis	1984-1975	
	DeVille	1981-1975	
	Eldorado	1978-1975	
	Eldorado	1981-1980	
	Fleetwood	1984-1975	
	Seville	1981-1980	
Chrysler	Concorde	1996-1993	
	Dynasty	1993-1990	
	Grand Voyager	2000	
	Imperial	1993-1990	
	Intrepid	1997-1993	
	New Yorker	1993-1990	
	Town & Country	2000-1990	
	Voyager	2000	
Dodge	Caravan	2000-1990	
	Dynasty	1993-1990	
	Grand Caravan	2000-1990	
	Intrepid	1997-1993	
Eagle	Vision	1997-1993	
Oldsmobile	Firenza	1988-1987	
Plymouth	Grand Voyager	2000-1990	
	Voyager	2000-1991	
Pontiac	LeMans	1993-1988	
	Optima	1991-1988	
	Sunbird	1988-1987	
3177		BR6EF	V-Power
Qty per Vehicle: 12		Box Qty: 10	
Jaguar	XJ12	1996-1994	
	XJRS	1993	
	XJS	1995	
3186		TR5GP	G-Power
Qty per Vehicle: 4-12		Box Qty: 4	
Aston Martin	DB7	2004	
Audi	V8 Quattro	1991-1990	
Buick	Allure	2009-2008	
	Century	1988-1986	
	Electra	1987-1986	
	LaCrosse	2009-2008	
	LeSabre	1988-1986	
	Rainier	2007-2004	
	Riviera	1987-1986	
	Skylark	1988-1986	
	Somerset	1987-1986	
	Somerset Regal	1985	
Cadillac	CTS	2007-2004	
	Escalade	2000-1999	
	Escalade	2014-2002	
	Escalade ESV	2014-2003	
	Escalade EXT	2013-2002	
	SRX	2006-2004	
	STS	2006-2005	
XLR	2006-2004		
Chevrolet	Avalanche	2013-2007	
	Avalanche 1500	2006-2002	
	C1500	1999-1998	
	C1500 Suburban	1999-1998	



3186 (Cont'd)	TR5GP	G-Power	3186 (Cont'd)	TR5GP	G-Power	
Qty per Vehicle: 4-12		Box Qty: 4	Qty per Vehicle: 4-12		Box Qty: 4	
Chevrolet	C2500	2000-1998	Ford	F-150	1998-1997	
	C2500 Suburban	1999-1998		F-150	2003-2000	
	C3500	2000-1998		F-150	2010	
	Camaro	2002-1998		F-150 Heritage	2004	
	Camaro	2015-2010		F-250	1999-1997	
	Caprice	2017-2011		Fairmont	1982-1978	
	Cavalier	2002-1999		Fiesta	1980	
	Colorado	2012-2009		Fusion	2012-2010	
	Corvette	2013-1993		Granada	1982-1981	
	Express 1500	2014-1998		LTD	1985-1983	
	Express 2500	2017-1998		Mustang	1986-1979	
	Express 3500	2017-1998		Mustang	1993-1991	
	Express 4500	2016-2009		Mustang	2000	
	Impala	2009-2006		Mustang II	1978-1974	
	K1500	1999-1998		Pinto	1980-1974	
	K1500 Suburban	1999-1998		Probe	1992-1990	
	K2500	2000-1998		Ranger	2009-1983	
	K2500 Suburban	1999-1998		Taurus	2007-1986	
	K3500	2000-1998		Tempo	1989-1984	
	Lumina	1995-1991		Tempo	1994-1992	
	Monte Carlo	1995		Thunderbird	1988-1983	
	Monte Carlo	2007-2006		Windstar	2000-1995	
	P30	1999-1998		GMC	C1500	1999-1998
	S10	2001-1999			C1500 Suburban	1999-1998
	S10	2003			C2500	2000-1998
	Silverado 1500	2013-1999			C2500 Suburban	1999-1998
	Silverado 1500 Classic	2007			C3500	2000-1998
	Silverado 1500 HD	2003-2001			Canyon	2012-2009
	Silverado 1500 HD	2006-2005			Envoy	2009-2005
	Silverado 1500 HD Classic	2007			Envoy XL	2006-2003
	Silverado 2500	2004-1999			Envoy XUV	2005-2004
	Silverado 2500 HD	2017-2001			K1500	1999-1998
	Silverado 2500 HD Classic	2007			K1500 Suburban	1999-1998
	Silverado 3500	2006-2001			K2500	2000-1998
	Silverado 3500 Classic	2007			K2500 Suburban	1999-1998
	Silverado 3500 HD	2017-2007			K3500	2000-1998
	SS	2017-2014			P3500	1999-1998
	SSR	2006-2003			Savana 1500	2014-1998
	Suburban 1500	2014-2000			Savana 2500	2017-1998
	Suburban 2500	2013-2000			Savana 3500	2017-1998
Suburban 3500 HD	2017-2016	Savana 4500	2016-2009			
Tahoe	2014-1998	Sierra 1500	2013-1999			
Trailblazer	2009-2006	Sierra 1500 Classic	2007			
Trailblazer EXT	2006-2003	Sierra 1500 HD	2003-2001			
Vega	1976-1975	Sierra 1500 HD	2006-2005			
DeLorean	DMC 12	1983-1981	Sierra 1500 HD Classic		2007	
	Monaco	1992-1990	Sierra 2500		2004-1999	
Dodge	Medallion	1989-1988	Sierra 2500 HD		2017-2001	
	Premier	1992-1988	Sierra 2500 HD Classic		2007	
Eagle	Aerostar	1997-1986	Sierra 3500		2006-2001	
	Bronco II	1990-1984	Sierra 3500 Classic		2007	
Ford	Courier	1982-1977	Sierra 3500 HD		2017-2007	
	E-250	2005-2003	Sonoma		2003-1998	
	E-250 Econoline	2002-1997	Yukon		2014-1998	
	E-350 Club Wagon	2005-2003	Yukon XL 1500		2014-2000	
	E-350 Econoline	1998-1997	Yukon XL 2500		2013-2000	
	E-350 Econoline Club Wagon	2002-1997	Hummer		H2	2009-2003
	E-350 Super Duty	2005-1999			H3	2010-2008
	E-450 Econoline Super Duty	2002-2000			H3T	2010-2009
	Econoline Super Duty	1999	Isuzu		Ascender	2006-2003
	Escape	2012-2009			Hombre	2000-1998
	Escort	1985-1982	Jaguar		XJ12	1988-1981
	EXP	1985-1982		XJS	1977	
	F-100	1983		XJS	1988-1979	
	F-150	1995-1993	Lincoln	Town Car	2010-2006	





3186 (Cont'd)		TR5GP	G-Power	3199 (Cont'd)		BKR6EQU	Laser Platinum
Qty per Vehicle: 4-12			Box Qty: 4	Qty per Vehicle: 4-12			Box Qty: 4
Mazda	6		2008-2003	Audi	A6		2001-1998
	B2300		1997-1994		A6 Quattro		2004-1998
	B2300		2010-2001		A8 Quattro		2006-1997
	B2500		2001-1998		Allroad Quattro		2005-2003
	B3000		2003-1994		S4		2009-2004
	MPV		2001-2000		S6		2003-2002
Mercedes-Benz	Tribute		2011-2009	Bentley	Arnage		1999
	190E		1993-1984		BMW	320i	
	260E		1989-1987	320i			2005-2001
	300CE		1989-1988	323Ci			2000
	300E		1993-1986	323i			2000-1998
	300SE		1991-1988	323is			1999-1998
300SEL		1991-1988	325Ci			2006-2001	
Mercury	300TE		1993-1988	325i			2005-2001
	Bobcat		1980-1975	325xi			2005-2001
	Capri		1977-1976	328Ci			2000
	Capri		1984-1979	328i			2000-1996
	Cougar		1982-1981	328is		1999-1996	
	Cougar		1986-1984	330Ci		2006-2001	
	LN7		1983-1982	330i		2005-2001	
	Lynx		1982	330xi		2005-2001	
	Lynx		1985-1984	525i		2005-2001	
	Mariner		2011-2009	528i		2000-1997	
	Marquis		1984-1983	530i		2005-2001	
	Milan		2011-2010	540i		2003-1998	
	Sable		2005-1986	545i		2005-2004	
	Topaz		1988-1984	645Ci		2005-2004	
Topaz		1994-1992	740i		2001-1998		
Zephyr		1982-1978	740iL		2001-1998		
Merkur	Scorpio		1989-1988	745i		2005-2002	
	XR4Ti		1989-1985	745Li		2005-2002	
Oldsmobile	98		1987-1986	750iL		2001-1998	
	Calais		1987-1985	760i		2006-2004	
	Cutlass Calais		1988	760Li		2008-2003	
	Cutlass Ciera		1988-1986	M3		1999-1996	
	Cutlass Cruiser		1988-1987	M5		2003-2000	
	Cutlass Supreme		1995-1991	X3		2006-2004	
	Delta 88		1988-1986	X5		2006-2000	
	Toronado		1987-1986	Z3		2002-1997	
Panoz	AIV Roadster		2000-1999	Z4		2005-2003	
	Esperante		2005-2001	Z8		2003-2000	
Peugeot	505		1991-1987	Cadillac	CTS		2004-2003
	604		1981-1977	Land Rover	Range Rover		2005-2003
Pontiac	Bonneville		1988-1987	Mini	Cooper		2008-2002
	Firebird		2002-1998	Morgan	Aero 8		2005-2004
	G8		2009-2008	Porsche	911		2002-2001
	Grand Am		1987-1985		911		2005
	Grand Prix		1995-1991		Boxster		2004-2001
	Grand Prix		2008-2005		Carrera GT		2005-2004
	GTO		2006-2004	Cayenne		2006-2003	
	Sunfire		2002-1999	Rolls-Royce	Park Ward		2002
Renault	Fuego		1985-1984	Phantom		2013-2004	
	R18i		1986-1984	Silver Seraph		2002-1999	
Saab	9-7x		2009-2005	Volkswagen	Golf		2000
	Volvo	262	1976	Passat		2005-1998	
Volvo	262		1981-1978	Phaeton		2006-2004	
	264		1982-1976	Touareg		2007-2004	
	265		1981-1976	Volvo	850		1997-1995
	760		1990-1983	960		1997-1995	
	780		1990-1987	S60		2005-2001	
<b>3199</b>	<b>BKR6EQU</b>	<b>Laser Platinum</b>		S70		2000-1998	
Qty per Vehicle: 4-12			Box Qty: 4	S80		2004-1999	
Audi	A4		1997	S90		1998-1997	
	A4		2001-1999	V70		2007-1998	
	A4 Quattro		2001-1998				



3199 (Cont'd)	BKR6EQJP	Laser Platinum
Qty per Vehicle: 4-12		Box Qty: 4
Volvo	V90	1998-1997
3200	PGR7A	Laser Platinum
Qty per Vehicle: 4-12		Box Qty: 4
Alfa Romeo	164	1993-1991
Audi	5000	1985-1984
Lamborghini	Countach	1981
Maserati	228i	1990-1989
	425	1987-1986
	Biturbo	1987
	Spyder	1987-1986
	Spyder	1991-1989
Mercedes-Benz	300SL	1959-1954
Porsche	944	1989
3207	UR45GP	G-Power
Qty per Vehicle: 4-8		Box Qty: 4
American Motors	Concord	1982-1980
	Eagle	1983-1981
	Spirit	1982-1980
Buick	Apollo	1975
	Century	1985-1975
	Electra	1975
	Electra	1985-1977
	Estate Wagon	1975
	Estate Wagon	1980-1978
	LeSabre	1985-1975
	Regal	1987-1975
	Riviera	1975
	Riviera	1978-1977
	Riviera	1984-1981
	Skyhawk	1980-1977
Cadillac	Skylark	1982-1975
	DeVille	1982-1980
	Eldorado	1982-1981
	Fleetwood	1982-1980
Checker	Seville	1982-1981
	Marathon	1975
Chevrolet	Marathon	1977
	Marathon	1982-1979
	Brookwood	1971
	Camaro	1983-1980
	Caprice	1985-1980
	Celebrity	1983-1982
	Citation	1983-1980
	El Camino	1984-1978
	Impala	1985-1980
	Malibu	1983-1978
	Monte Carlo	1987-1978
	Monza	1975
	Monza	1980-1978
	Nova	1970
Excalibur	Phaeton	1989-1971
Ford	Bronco	1996-1989
	Custom 500	1977
	E-150 Econoline	1996-1989
	E-150 Econoline Club Wagon	1996-1986
	E-250 Econoline	1991-1989
	F-150	1996-1989
	F-250	1996-1989
	Fairmont	1982-1978
	Granada	1981-1977
	LTD	1985-1977
	LTD II	1979-1977
	Maverick	1977
	Mustang	1982-1979

3207 (Cont'd)	UR45GP	G-Power	
Qty per Vehicle: 4-8		Box Qty: 4	
Ford	Mustang	1985-1984	
	Mustang	1995-1987	
	Mustang II	1978-1977	
	P-400	1976	
	P-500	1977-1976	
	Ranchero	1979-1975	
	Thunderbird	1974	
	Thunderbird	1982-1977	
	Thunderbird	1985-1984	
	Thunderbird	1993-1991	
	GMC	Caballero	1984-1978
	Jeep	CJ5	1983-1980
		CJ7	1983-1980
		Scrambler	1983-1981
Lincoln	Continental	1974	
	Continental	1980-1977	
	Continental	1985-1982	
	Mark IV	1974	
	Mark V	1979-1977	
	Mark VI	1983-1980	
	Mark VII	1985-1984	
	Mark VII	1992-1987	
	Town Car	1985-1981	
	Versailles	1980-1977	
	Mercury	Capri	1983-1979
Colony Park		1974	
Comet		1977	
Cougar		1974	
Cougar		1985-1977	
Cougar		1993-1991	
Grand Marquis		1985-1977	
Marquis		1974	
Marquis		1982-1977	
Monarch		1980-1977	
Montego		1974	
Monterey	1974		
Zephyr	1982-1978		
Oldsmobile	98	1975	
	98	1983-1981	
	98	1985	
	Custom Cruiser	1975	
	Cutlass	1981-1977	
	Cutlass Calais	1984-1978	
	Cutlass Ciera	1985-1982	
	Cutlass Cruiser	1983-1980	
	Cutlass Salon	1980-1978	
	Cutlass Salon	1987-1985	
	Cutlass Supreme	1987-1977	
	Delta 88	1975	
	Delta 88	1985-1977	
	Omega	1975	
Omega	1983-1977		
Starfire	1980-1977		
Toronado	1984-1981		
Pontiac	6000	1983-1982	
	Astre	1977	
	Bonneville	1986-1975	
	Catalina	1981-1975	
	Firebird	1983-1975	
	Grand Am	1975	
	Grand Am	1980-1978	
	Grand LeMans	1983-1975	
	Grand Prix	1987-1975	
	Grand Safari	1978-1975	
	Grandville	1975	



3207 (Cont'd)		UR45GP	G-Power
Qty per Vehicle: 4-8			Box Qty: 4
Pontiac	Laurentian		1977-1976
	Laurentian		1981-1980
	LeMans		1981-1975
	Parisienne		1977-1976
	Parisienne		1985-1980
	Phoenix		1983-1977
	Sunbird		1980-1977
	Ventura		1977-1975

3210		B-4	Standard
Qty per Vehicle: 6-8			Box Qty: 10
Pontiac	Bonneville		1958-1957
	Catalina		1958-1950
	Chieftain		1958-1950
	Star Chief		1958-1954
	Streamliner		1952-1950
	Super Chief		1958-1957

3212		B-6L	Standard
Qty per Vehicle: 6-8			Box Qty: 10
American Motors	Ambassador		1963-1958
	Ambassador		1967-1966
	Classic		1963
	Classic		1966
	Rebel		1961-1960
Ford	Club		1953
	Country Sedan		1954-1950
	Country Squire		1954-1950
	Courier Sedan Delivery		1954
	Crestline		1954-1950
	Custom		1952-1950
	Customline		1954-1952
	Deluxe		1951-1950
	F1		1952-1950
	F2		1952-1950
	F3		1952-1950
	Mainline		1954-1952
	Ranch Wagon		1954-1950
	Skyliner		1954
	Sunliner		1954-1952
	Victoria		1954-1951
Jeep	Gladiator		1967-1965
	J-100		1968-1965
	J-2500		1968-1965
	J-2600		1968
	J-2700		1968
	J-2800		1968
	J-3500		1968
	J-3600		1968
	J-3700		1968
	J-3800		1968
	Wagoneer		1967-1965

3248		FR5GP	G-Power
Qty per Vehicle: 4			Box Qty: 4
Ford	Escort		1981
	EXP		1982
Mercedes-Benz	SLK230		2000-1998
Mercury	LN7		1982
	Lynx		1981

3271		PZFR6F-11	Laser Platinum
Qty per Vehicle: 4-10			Box Qty: 4
Acura	EL		2005-2001
BMW	550i		2010-2006
	650i		2010-2006
	750i		2008-2006
	750Li		2008-2006

3271 (Cont'd)		PZFR6F-11	Laser Platinum
Qty per Vehicle: 4-10			Box Qty: 4
BMW	X5		2010-2004
Chevrolet	Aveo		2011-2009
	Aveo5		2011-2009
Chrysler	Aspen		2007
Dodge	B1500		1998-1997
	B2500		1998-1997
	B3500		1998-1997
	Colt		1992
	Dakota		2010-1997
	Durango		2009-1998
	Nitro		2011-2007
	Ram 1500		2010-1997
	Ram 1500 Van		2003-1999
	Ram 2500		2003-1997
	Ram 2500 Van		2003-1999
	Ram 3500		2003-1997
	Ram 3500 Van		2003-1999
Ford	Probe		1997-1989
Honda	Civic		2005-2001
	CR-V		2001-1999
	Prelude		2001-1992
Jeep	Commander		2010-2006
	Grand Cherokee		2010-1999
	Liberty		2012-2002
Mazda	626		1992-1990
	MX-6		1992-1990
	Protege		2003
Mitsubishi	Raider		2009-2006
Plymouth	Colt		1992
Pontiac	G3		2010-2009
	G3 Wave		2009
Ram	1500		2013-2011
	Dakota		2011
Suzuki	Swift+		2009

3306		BCPR5EIX-11	Iridium IX
Qty per Vehicle: 4-6			Box Qty: 4
Acura	Integra		1991-1990
Chevrolet	Nova		1988
Ford	Escort		1981
	EXP		1982
Honda	CRX		1991-1988
	Prelude		1990-1988
Mercedes-Benz	SLK230		2000-1998
Mercury	LN7		1982
	Lynx		1981
Nissan	200SX		1988-1984
	D21		1989-1986
	Multi		1988-1986
	Pathfinder		1989-1987
	Pulsar NX		1990-1989
	Sentra		1990-1989
	Stanza		1989-1984
Toyota	Camry		1991-1987
	Celica		1989-1986
	Corolla		1989-1985
	Cressida		1992-1989
	MR2		1989-1985
	Supra		1992-1986

3323		AR6FS	Standard
Qty per Vehicle: 6-8			Box Qty: 10
Dodge	D100 Pickup		1969-1968
	D200 Pickup		1969-1968
	D250		1991-1987
	D250		1993



3323 (Cont'd)		AR6FS	Standard	3332 (Cont'd)		XR5	V-Power		
Qty per Vehicle: 6-8			Box Qty: 10	Qty per Vehicle: 4-8			Box Qty: 4		
Dodge	D300 Pickup		1969-1968	Chevrolet	Kingswood		1970-1969		
	D350		1993-1987		Monte Carlo		1970		
	M300		1974		Nova		1970		
	M350		1974		P20 Van		1968		
	W100 Pickup		1969-1968		P30 Van		1968		
	W100 Series		1966-1964		Townsmen		1970-1969		
	W200 Pickup		1969		Chrysler	300		1971-1959	
	W200 Series		1966-1964			Cordoba		1976-1975	
	W250		1991-1987			Newport		1966-1965	
	W250		1993			New Yorker		1974-1973	
	W300 Pickup		1969-1968			Town & Country		1966-1963	
	W300 Series		1966-1964			Town & Country		1971-1970	
	W350		1993-1987			Town & Country		1974-1973	
Ford	Bronco		1966	Town & Country			1977-1976		
	Courier Sedan Delivery		1958-1957	Dodge		880		1965-1964	
	F-100		1964-1960			B100 Van		1974	
	F-250		1964-1960		B200		1978-1975		
	F-350		1964-1960		B200 Van		1974		
	F-500		1977-1975		B300		1978-1975		
	F Series		1959-1957		CB300		1979-1976		
	Ranchero		1959-1957		Challenger		1971-1970		
	Ranchero		1966-1963		Charger		1978-1967		
	3332	XR5	V-Power		Box Qty: 4	Qty per Vehicle: 4-8	Coronet		1976-1965
D100								1978-1975	
D100 Pickup							1974-1973		
D150							1978-1977		
D200							1978-1975		
D200 Pickup							1974-1973		
D300							1978-1975		
D300 Pickup							1974-1973		
D400							1978		
D450							1978		
Dart							1962-1961		
Dart							1969-1968		
Lancer							1961		
Magnum		1978							
Monaco		1965							
Monaco		1978-1968							
Polara		1962-1960							
Polara		1968-1964							
Polara		1973-1972							
Ramcharger		1978-1974							
Royal Monaco		1977-1975							
W100		1977-1975							
W100 Pickup		1974							
W100 Series		1966-1960							
W150		1978-1977							
W200		1978-1975							
W200 Pickup		1974							
W200 Series		1966-1960							
W300		1978-1975							
W300 Series		1966-1960							
Wm300 Power Wagon		1962-1960							
Checker	Marathon		1970-1968	Excalibur		1970-1965			
				Chevrolet					
Bel Air		1970-1969							
Biscayne		1970-1969							
Brookwood		1970-1969							
C10 Pickup		1968							
C10 Suburban		1968							
C20 Pickup		1968							
C20 Suburban		1968							
C30 Pickup		1968							
Camaro		1970-1967							
Caprice		1970-1969							
Chevelle		1970-1969							
Chevy II		1968-1965							
Corvette		1970-1962							
G10 Van		1968							
G20 Van		1968							
Impala		1970-1963							
K10 Pickup		1968							
K10 Suburban		1968							
K20 Pickup		1968							
K20 Suburban		1968							
K30 Pickup		1968							
GMC									
							Phaeton		1970-1965
							C15/C1500 Pickup		1968
							C15/C1500 Suburban		1968
							C25/C2500 Pickup		1968
							C25/C2500 Suburban		1968
							C35/C3500 Pickup		1968
							G15/G1500 Van		1968
							G25/G2500 Van		1968
							K15/K1500 Pickup		1968
K15/K1500 Suburban		1968							
K25/K2500 Pickup		1968							
K25/K2500 Suburban		1968							



3332 (Cont'd)			3332 (Cont'd)			
	XR5	V-Power		XR5	V-Power	
Qty per Vehicle: 4-8		Box Qty: 4	Qty per Vehicle: 4-8		Box Qty: 4	
GMC	K35/K3500 Pickup	1968	Plymouth	Road Runner	1975-1968	
	P25/P2500 Van	1968		Satellite	1974-1966	
	P35/P3500 Van	1968		Savoy	1960	
International	100	1974		Sport Wagon	1960	
	150	1975		Suburban	1960	
	200	1975-1974		Superbird	1970	
	908C	1969-1968		Trailduster	1978-1974	
	1000C	1968		Pontiac	Bonneville	1969-1968
	1000D	1970-1969			Catalina	1969-1967
	1010	1973-1971			Executive	1969-1967
	1100C	1968	Firebird		1969-1967	
	1100D	1970-1969	Grand Prix		1969-1968	
	1110	1973-1971	GTO		1969-1967	
	1200C	1968	LeMans		1969-1968	
	1200D	1970-1969	Tempest		1969-1968	
	1210	1973-1971	<b>3346 BR7EF V-Power</b>			
	1300C	1968	Qty per Vehicle: 12		Box Qty: 10	
	1300D	1970-1969	Jaguar	XJ12	1992-1991	
	1310	1973-1971		XJS	1992-1991	
	M800	1971-1968		XJS	1994	
	M800 Navy	1969	<b>3350 BCPR6EP-11 Laser Platinum</b>			
	M800 Post Office	1972-1969	Qty per Vehicle: 4-6		Box Qty: 4	
	M1100	1972-1968	Honda	Civic	1991-1988	
	M1200	1972-1968		CRX	1991-1988	
	M1400	1969		Prelude	1990-1988	
	MA1200	1971-1968	Lexus	ES250	1991-1990	
MHC1310	1974	ES300		1993-1992		
MS	1975	Mazda	323	1989-1988		
MS1210	1974-1972	Toyota	Camry	1993-1988		
M Series Van	1964-1961		MR2	1989-1988		
Scout	1971-1961	<b>3351 GR5GP G-Power</b>				
Scout II	1980-1971	Qty per Vehicle: 3-8		Box Qty: 4		
Travelall	1975	Buick	Skyhawk	1987-1982		
Jensen	Interceptor	1976-1970	Chevrolet	Bel Air	1969-1961	
Oldsmobile	88	1957		Biscayne	1969-1961	
	98	1969-1958		C10 Pickup	1969-1968	
	442	1969-1965		C10 Suburban	1969-1968	
	Cutlass	1968-1964		C20 Pickup	1969-1968	
	Cutlass Supreme	1967		C20 Suburban	1969-1968	
	Delmont 88	1967		C30 Pickup	1969-1968	
	Delta 88	1967-1965		Camaro	1969-1967	
	Dynamic	1966-1958		Caprice	1969-1966	
	F85	1966-1964		Chevelle	1969-1966	
	Fiesta	1964-1957		Chevy II	1968	
	Jetstar 88	1966-1964		Corvette	1969-1966	
	Jetstar I	1965-1964		El Camino	1970-1966	
	Starfire	1957		Impala	1969-1961	
	Starfire	1966-1961		K10 Pickup	1969-1968	
	Super 88	1964-1957		K10 Suburban	1969-1968	
	Toronado	1967-1966		K20 Pickup	1969-1968	
	Vista Cruiser	1969-1964		K30 Pickup	1969-1968	
Plymouth	Barracuda	1971-1967		Malibu	1967-1966	
	Belvedere	1960		Nova	1970	
	Belvedere	1965-1963		S10	1985-1982	
	Belvedere	1970-1967		S10 Blazer	1984-1983	
	Cuda	1971-1970		Spectrum	1988-1985	
	Fury	1960	Sprint	1988-1985		
	Fury	1978-1967	Dodge	Charger	1967	
	Fury I	1974-1968		Coronet	1971-1967	
	Fury II	1974-1968		Polara	1966	
	Fury III	1974-1968	Ford	Courier	1979-1972	
	Gran Fury	1977-1972		Courier	1981	
	GTX	1971-1968		Mustang II	1976-1974	
	PB200	1978-1976		Pinto	1973-1971	
	PB300	1978-1976				





3351 (Cont'd)	GR5GP	G-Power
Qty per Vehicle: 3-8		Box Qty: 4
Ford	Pinto	1976-1975
Geo	Spectrum	1989
GMC	C15/C1500 Pickup	1969-1968
	C15/C1500 Suburban	1968
	C25/C2500 Pickup	1969-1968
	C25/C2500 Suburban	1968
	C35/C3500 Pickup	1969-1968
	K15/K1500 Pickup	1969-1968
	K15/K1500 Suburban	1968
	K25/K2500 Pickup	1969-1968
	K25/K2500 Suburban	1968
	K35/K3500 Pickup	1969-1968
S15		1985-1982
S15 Jimmy		1984-1983
International	100	1974
	200	1974
	1010	1973-1972
	1110	1973-1972
	1210	1973-1972
	1310	1973-1972
	M800 Post Office	1972
	M1100	1972
	M1200	1972
	MHC1310	1974
Plymouth	Belvedere	1966
	Cuda	1971-1970
	Fury	1966-1963
	Satellite	1967-1965
Pontiac	Firefly	1988-1985
	Grand Am	1989-1987
	J2000	1983-1982
	J2000 Sunbird	1985-1984
	Sunbird	1990-1986
	Sunbird	1994-1992
Sunburst	1988-1985	
3381	LZTR5AGP	G-Power
Qty per Vehicle: 4-16		Box Qty: 4
Chrysler	300	2010-2005
	Concorde	2004-1998
	Intrepid	2004-1998
	Pacifica	2008-2005
	PT Cruiser	2009-2003
	Sebring	2010-2001
	Town & Country	2010-2001
	Voyager	2003-2001
Dodge	Avenger	2010-2008
	Caravan	2007-2001
	Challenger	2010-2008
	Charger	2010-2006
	Grand Caravan	2010-2001
	Intrepid	2004-1998
	Magnum	2008-2005
	Neon	2005-2003
	Stratus	2006-2001
	Viper	2010-2008
	Viper	2017-2015
Jeep	Grand Cherokee	2010-2006
	Wrangler	2011-2007
SRT	Viper	2014-2013
Volkswagen	Routan	2010-2009
3403	TR55GP	G-Power
Qty per Vehicle: 4-12		Box Qty: 4
Aston Martin	DB7	2003-2002

3403 (Cont'd)	TR55GP	G-Power
Qty per Vehicle: 4-12		Box Qty: 4
Buick	Allure	2009-2005
	Century	2005-1989
	Commercial Chassis	1996-1994
	Electra	1990-1988
	LaCrosse	2009-2005
	LeSabre	2005-1988
	Lucerne	2011-2006
	Park Avenue	2005-1991
	Reatta	1991-1988
	Regal	2004-1990
	Rendezvous	2007-2002
	Riviera	1993-1988
	Riviera	1999-1995
	Roadmaster	1996-1994
	Skylark	1998-1989
	Terraza	2006-2005
	Cadillac	60 Special
Allante		1993-1987
Commercial Chassis		1996-1985
DeVille		2005-1982
DTS		2011-2006
Eldorado		2002-1982
Fleetwood		1992-1982
Fleetwood		1996-1994
Seville		2004-1982
SRX		2009-2007
STS		2010-2007
XLR		2009-2007
Chevrolet		Astro
	Avalanche 2500	2006-2002
	Beretta	1996-1994
	Blazer	2005-1996
	C1500	1999-1996
	C1500 Suburban	1997-1996
	C2500	1993-1992
	C2500	2000-1996
	C2500 Suburban	1999-1996
	C3500	2000-1996
	C3500HD	2002-2001
	C4500 Kodiak	2009-2008
	C5500 Kodiak	2009-2008
	C6500 Kodiak	2009-2008
	C7500 Kodiak	2009-2008
	Camaro	2002-1993
	Caprice	1996-1994
	Cavalier	2002-1995
	Corsica	1996-1994
	Corvette	1996-1992
	Equinox	2009-2005
	Express 1500	2014-1996
	Express 2500	2005-1996
Express 3500	2002-1996	
G30	1995	
Impala	1996-1994	
Impala	2005-2000	
K1500	1999-1996	
K1500 Suburban	1997-1996	
K2500	1993-1992	
K2500	2000-1996	
K2500 Suburban	1999-1996	
K3500	2000-1996	
Lumina	2001-1995	
Lumina APV	1996-1992	
Malibu	2006-1997	
Monte Carlo	2005-1995	



3403 (Cont'd)		TR55GP	G-Power	3403 (Cont'd)		TR55GP	G-Power
Qty per Vehicle: 4-12			Box Qty: 4	Qty per Vehicle: 4-12			Box Qty: 4
Chevrolet	P30		1999-1996	GMC	C4500 Topkick		2009-2008
	S10		2004-1996		C5500 Topkick		2009-2008
	Silverado 1500		2013-1999		C6500 Topkick		2009-2008
	Silverado 1500 Classic		2007		C7500 Topkick		2009-2008
	Silverado 2500 HD		2006-2001		Jimmy		2005-1996
	Silverado 2500 HD Classic		2007		K1500		1999-1996
	Silverado 3500		2006-2001		K1500 Suburban		1997-1996
	Silverado 3500 Classic		2007		K2500		2000-1996
	Suburban 2500		2006-2001		K2500 Suburban		1999-1996
	Tahoe		1997-1996		K3500		2000-1996
	Uplander		2006-2005		P3500		1999-1996
	Venture		2005-1997		Safari		2005-1996
	Ford	Aerostar			1997-1990	Savana 1500	
Contour			2000-1995		Savana 2500		2005-1996
Crown Victoria			2011-1992		Savana 3500		2002-1996
E-150			2014-2003		Sierra 1500		2013-1999
E-150 Club Wagon			2005-2003		Sierra 1500 Classic		2007
E-150 Econoline			2002-1997		Sierra 2500 HD		2006-2001
E-150 Econoline Club Wagon			2002-1997		Sierra 2500 HD Classic		2007
E-250			2014-2003		Sierra 3500		2006-2001
E-250 Econoline			2002-1997		Sierra 3500 Classic		2007
E-350 Club Wagon			2005-2003		Sonoma		2004-1996
E-350 Econoline			1998-1997	Yukon		1997-1996	
E-350 Econoline Club Wagon			2002-1997	Yukon XL 2500		2006-2001	
E-350 Super Duty			2017-1999	Isuzu	Hombre		1999-1997
E-450 Econoline Super Duty			2002-1999	Lincoln	Aviator		2005-2003
E-450 Super Duty			2017-2003		Blackwood		2002
E-550 Econoline Super Duty			2002		Continental		2002-1995
E-550 Super Duty			2003		LS		2005-2000
Econoline Super Duty			1999-1997		Mark VIII		1998-1993
Escape			2008-2001		Navigator		2004-1998
Excursion			2005-2000		Town Car		2008-1991
Expedition			2004-1997		Town Car		2011
Explorer			2005-1991		Zephyr		2006
Explorer Sport			2003-2001		Mazda	5	
Explorer Sport Trac			2005-2001	6			2005-2003
F53			2004-1999	B3000			2008-2004
F-150			2009-1997	B4000			1996-1994
F-150 Heritage			2004	B4000			2003
F-250			1999-1997	MPV			2006-2002
F-250 Super Duty			2004-1999	Navajo			1994-1991
F-350 Super Duty			2004-1999	Tribute			2006-2001
F-450 Super Duty			2004-1999	Tribute			2008
F-550 Super Duty			2004-1999	Mercury		Cougar	
Fiesta			1979-1978		Cougar		2002-1999
Five Hundred			2007-2005		Grand Marquis		2011-1992
Focus			2011		Marauder		2004-2003
Freestar			2005-2004		Mariner		2008-2005
Freestyle			2007-2005		Milan		2009-2006
Fusion			2009-2006		Montego		2007-2005
Mustang			2004-1993		Mountaineer		2006-1997
Ranger			1996-1990		Mystique		2000-1995
Ranger			2008		Sable		2005-1996
Ranger			2011-2010	Topaz		1994-1989	
Taurus			2005-1996	Oldsmobile	88		1999-1992
Tempo			1994-1989		98		1996-1988
Thunderbird			1997-1994		Achieva		1998-1992
Transit Connect			2013-2010		Alero		2004-1999
Windstar			2003-1996		Aurora		1999-1995
GMC	C1500		1999-1996		Aurora		2003-2001
	C1500 Suburban		1997-1996		Bravada		2001-1996
	C2500		2000-1996		Cutlass		1999-1997
	C2500 Suburban		1999-1996		Cutlass Calais		1991-1989
	C3500		2000-1996		Cutlass Ciera		1996-1989
	C3500HD		2002-1996	Cutlass Cruiser		1994-1989	



3403 (Cont'd)		TR55GP	G-Power
Qty per Vehicle: 4-12			Box Qty: 4
Oldsmobile	Cutlass Supreme		1997-1993
	Delta 88		1991-1988
	Intrigue		2002-1998
	LSS		1999-1996
	Regency		1998-1997
	Silhouette		2004-1992
	Toronado		1992-1988
Pontiac	Aztek		2005-2001
	Bonneville		2005-1988
	Firebird		2002-1993
	G6		2006-2005
	Grand Am		2005-1992
	Grand Prix		2008-1994
	Montana		2006-1999
	Sunfire		2002-1995
	Torrent		2009-2006
	Trans Sport		1999-1992
Saturn	Relay		2006-2005
3419		BR6HIX	Iridium IX
Qty per Vehicle: 4-6			Box Qty: 4
Aston Martin	DB		1959-1957
	DB2-4		1957-1953
	DB3		1956-1953
	DBD		1959-1958
Chevrolet	Corvair		1965-1962
Volkswagen	Beetle		1979-1954
	Campmobile		1971-1968
	Fastback		1973-1966
	Karmann Ghia		1974-1956
	Squareback		1973-1966
	Super Beetle		1980-1971
	Thing		1974-1973
	Transporter		1966-1954
3437		DR9EA	Standard
Qty per Vehicle: 12			Box Qty: 10
Lamborghini	Diablo		1996-1992
3440		BKR5EP-11	Laser Platinum
Qty per Vehicle: 4-6			Box Qty: 4
Chevrolet	Prizm		2002-2000
	Tracker		2002-2001
Chrysler	Sebring		2005-2001
Geo	Prizm		1989
	Storm		1993-1992
Lexus	GS300		1997-1994
	SC300		1992
	SC300		1998-1994
Mazda	323		1994-1993
	Miata		2005-2004
	Protege		1994-1990
Saturn	SC		1992-1991
	SC2		2002-1993
	SL2		2002-1991
	SW2		2001-1993
Scion	xB		2015-2014
Toyota	4Runner		2000
	Celica		1990
	Celica		2002-2000
	Celica		2005-2004
	Corolla		2002-2000
	Echo		2000
	Matrix		2004
	MR2		1991
	MR2 Spyder		2002-2000
	Paseo		1995-1992

3440 (Cont'd)		BKR5EP-11	Laser Platinum
Qty per Vehicle: 4-6			Box Qty: 4
Toyota	Previa		1995-1991
	Prius		2002-2001
	Supra		1997-1993
	Tacoma		2004-2000
	Yaris		2010
	Yaris		2017-2015
Volkswagen	Beetle		2004
3452		BKR6EKP-11	Laser Platinum
Qty per Vehicle: 4-6			Box Qty: 4
Lexus	ES300		1998-1996
Toyota	Avalon		1999-1996
	Camry		2001-1996
	RAV4		2000-1997
	Sienna		2000-1998
	Solara		2001-1999
3459		ZFR5N	V-Power
Qty per Vehicle: 4-10			Box Qty: 4
Dodge	Dakota		2002-1999
	Ram 1500		2006-2004
	Viper		2006-2003
Jeep	Cherokee		2001-1999
	Grand Cherokee		2004-1999
	TJ		2006-1997
	Wrangler		2006-1999
3474		ILTR5B11	Laser Iridium
Qty per Vehicle: 4-8			Box Qty: 4
Buick	Rainier		2007-2004
Cadillac	Escalade		2017-2015
	Escalade ESV		2017-2015
Chevrolet	Camaro		2017-2016
	Cobalt		2008-2006
	Colorado		2009-2004
	Corvette		2017-2014
	HHR		2008-2006
	Malibu		2008-2007
	Silverado 1500		2017-2014
	Suburban		2017-2015
	Tahoe		2017-2015
	Trailblazer		2009-2002
Trailblazer EXT		2006	
GMC	Canyon		2009-2004
	Envoy		2009-2002
	Envoy XL		2006
	Sierra 1500		2017-2014
	Yukon		2017-2015
	Yukon XL		2017-2015
Hummer	H3		2009-2006
	H3T		2009
Isuzu	Ascender		2008-2003
	i-280		2006
	i-290		2008-2007
	i-350		2006
	i-370		2008
Oldsmobile	Bravada		2004-2002
Pontiac	G5		2010-2007
	G6		2009-2006
	Pursuit		2006
	Solstice		2009-2006
Saab	9-7x		2009-2005
Saturn	Aura		2008-2007
	Ion		2007-2006
	Sky		2008-2007
	Vue		2010-2007



3481		DCPR6E	Standard	3522 (Cont'd)		BR6S	Standard	
Qty per Vehicle: 6			Box Qty: 10	Qty per Vehicle: 4-8			Box Qty: 10	
BMW	M5		1993-1991	GMC	Jimmy		1970	
3500		PFR6B	Laser Platinum	K15/K1500 Pickup			1970-1967	
Qty per Vehicle: 4-6			Box Qty: 4	K15/K1500 Suburban			1970-1968	
Alfa Romeo	164		1995-1991	K25/K2500 Pickup			1970-1967	
Porsche	911		2009-2007	K25/K2500 Suburban			1970-1968	
Volvo	850		1997-1995	K35/K3500 Pickup			1970-1968	
	C70		2004-1998	P15/P1500 Van			1967	
	S40		2004-2000	P25/P2500 Van			1967	
	S60		2009-2001	P25/P2500 Van			1970-1969	
	S70		2000-1998	P35/P3500 Van			1967	
	S80		2006-1999	P35/P3500 Van			1970-1969	
	V40		2004-2000					
	V70		2007-1998					
	XC70		2007-2003					
	XC90		2006-2003					
3508		IFR5T-8N	Laser Iridium	Jeep	CJ3		1960-1959	
Qty per Vehicle: 4			Box Qty: 4		CJ5		1960-1959	
Mazda	Miata		2005-2004		CJ5		1971-1968	
3522		BR6S	Standard		CJ6		1960-1959	
Qty per Vehicle: 4-8			Box Qty: 10		CJ6		1971-1968	
Chevrolet	Bel Air		1968-1962		Commando		1967	
	Bel Air		1970		Dispatcher		1967-1961	
	Biscayne		1970		DJ3		1960-1959	
	Blazer		1970-1969		DJ5		1971-1967	
	Brookwood		1970		F4-134		1960	
	C10 Pickup		1970-1961		FC150		1966-1960	
	C10 Suburban		1970-1968		FC170		1966-1963	
	C20 Pickup		1970-1961		Jeepster		1971-1967	
	C20 Suburban		1970-1968		Universal		1967-1961	
	C30 Pickup		1970-1961		Utility		1962-1961	
	Caprice		1970					
	Chevelle		1970		Plymouth	Belvedere		1959-1957
	Corvette		1968-1953			Deluxe		1950
	El Camino		1970-1964			Fury		1959-1957
	G10 Van		1970-1969			Plaza		1958-1957
	G20 Van		1970-1969			Savoy		1959-1957
	Impala		1970			Suburban		1950
	K10 Pickup		1970-1961			Suburban		1959-1957
	K10 Suburban		1970-1968					
	K20 Pickup		1970-1961		Pontiac	LeMans		1966
	K20 Suburban		1970-1968			Tempest		1966
	K30 Pickup		1970-1968					
	Kingswood		1970					
	Monte Carlo		1970					
	P10 Series		1962					
	P20 Series		1962-1961					
	P20 Van		1970-1969					
	P30 Series		1962-1961					
	P30 Van		1970-1969					
	Suburban		1966-1961					
	Dodge	Coronet		1952-1950				
		M300		1968				
		Meadowbrook		1952-1950				
		Wayfarer		1952-1950				
		Wm300 Pickup		1967				
GMC	C15/C1500 Pickup		1970-1967					
	C15/C1500 Suburban		1970-1968					
	C25/C2500 Pickup		1970-1967					
	C25/C2500 Suburban		1970-1968					
	C35/C3500 Pickup		1970-1967					
	G15/G1500 Van		1967					
	G15/G1500 Van		1970-1969					
	G25/G2500 Van		1967					
	G25/G2500 Van		1970-1969					
3546		PFR6N-11	Laser Platinum					
Qty per Vehicle: 4-8			Box Qty: 4					
Acura	NSX		1996-1995					
Land Rover	Discovery		2004-1999					
	Freelander		2005-2002					
Lotus	Elise		2007-2005					
	Exige		2006					
3547		UR5GP	G-Power					
Qty per Vehicle: 4-8			Box Qty: 4					
AM General	Hummer		1996-1995					
Buick	Century		1986-1983					
	Commercial Chassis		1993-1992					
	Roadmaster		1993-1992					
	Skyhawk		1986-1982					
	Skylark		1985-1980					
Cadillac	Brougham		1992-1990					
	Cimarron		1986-1982					
	Commercial Chassis		1992					
Chevrolet	Astro		1995-1985					
	Bel Air		1971					
	Biscayne		1971					
	Blazer		1995-1987					
	C10		1986-1984					
	C10 Suburban		1986-1984					
	C20		1986-1985					
	C20 Suburban		1986-1984					
	C1500		1995-1988					
	C1500 Suburban		1995-1992					
C2500		1995-1988						



3547 (Cont'd)	UR5GP	G-Power	3547 (Cont'd)	UR5GP	G-Power	
Qty per Vehicle: 4-8		Box Qty: 4	Qty per Vehicle: 4-8		Box Qty: 4	
Chevrolet	C2500 Suburban	1995-1992	Ford	C700	1986	
	C3500	1995-1988		C800	1986	
	C3500HD	1995-1991		E-100 Econoline	1975	
	Camaro	1995-1982		E-100 Econoline	1982-1980	
	Caprice	1971		E-100 Econoline Club Wagon	1982-1980	
	Caprice	1993-1989		E-150 Econoline	1975	
	Cavalier	1986-1982		E-150 Econoline	1996-1980	
	Celebrity	1986-1982		E-150 Econoline Club Wagon	1996-1980	
	Chevette	1987-1976		E-250 Econoline	1975	
	Citation	1983-1980		E-250 Econoline	1996-1980	
	Citation II	1985-1984		E-250 Econoline Club Wagon	1980	
	Corvette	1971		E-250 Econoline Club Wagon	1991-1985	
	Corvette	1987-1985		E-350 Econoline	1975	
	El Camino	1971		E-350 Econoline	1982-1980	
	El Camino	1986		E-350 Econoline	1996-1985	
	G10	1995-1984		E-350 Econoline Club Wagon	1991-1985	
	G20	1995-1984		Econoline Super Duty	1996	
	G30	1996-1984		F53	1997	
	K5 Blazer	1986-1984		F-100	1975	
	K10	1986-1985		F-100	1983-1980	
	K10 Suburban	1986-1984		F-150	1975	
	K20	1986-1985		F-150	1996-1980	
	K20 Suburban	1986-1984		F-250	1996-1980	
	K30	1985		F-250 HD	1997	
	K1500	1995-1988		F-350	1975	
	K1500 Suburban	1995-1992		F-350	1980	
	K2500	1995-1988		F-350	1997-1984	
	K2500 Suburban	1995-1992		Falcon	1970	
	K3500	1995-1988		F Super Duty	1997	
	Lumina APV	1995-1990		Mustang	1983	
	Monte Carlo	1971		Thunderbird	1983	
	Monte Carlo	1986-1985		GMC	C1500	1986-1984
	Monza	1977-1976			C1500	1995-1988
	P20	1989-1987			C1500 Suburban	1986-1984
	P30	1997-1987			C1500 Suburban	1995-1992
	P40	1988			C2500	1986-1985
	R10	1987			C2500	1995-1988
	R10 Suburban	1988-1987			C2500 Suburban	1986-1985
	R20	1988-1987			C2500 Suburban	1995-1992
	R20 Suburban	1988-1987			C3500	1995-1988
	R30	1988-1987			C3500HD	1995-1991
	R1500 Suburban	1991-1989			Caballero	1986
	R2500	1989			G1500	1995-1984
	R2500 Suburban	1991-1989			G2500	1995-1984
	R3500	1991-1989			G3500	1996-1984
	S10	1995-1982			Jimmy	1995-1984
	S10 Blazer	1994-1983			K1500	1986-1985
	Tahoe	1995			K1500	1995-1988
	V10	1987			K1500 Suburban	1986-1984
	V10 Suburban	1988-1987			K1500 Suburban	1995-1992
	V20	1987			K2500	1986-1985
	V20 Suburban	1988-1987			K2500	1995-1988
	V30	1988-1987			K2500 Suburban	1995-1992
V1500 Suburban	1991-1989	K3500	1995-1988			
V2500 Suburban	1991-1989	P25	1976			
V3500	1991-1989	P35	1976			
Vega	1974-1971	P2500	1989-1988			
Vega	1977-1976	P3500	1997-1987			
Dodge	M300	1974	R1500		1987	
	M350	1974	R1500 Suburban		1991-1987	
Ford	B600	1989-1986	R2500		1989-1987	
	B700	1989-1986	R2500 Suburban		1991-1987	
	Bronco	1975	R3500		1991-1987	
	Bronco	1996-1980	S15		1990-1982	
	C600	1986	S15 Jimmy		1991-1983	





3547 (Cont'd)		UR5GP	G-Power	3573 (Cont'd)		PGR5A-11	Laser Platinum	
Qty per Vehicle: 4-8			Box Qty: 4	Qty per Vehicle: 3-6			Box Qty: 4	
GMC	Safari		1995-1985	Dodge	Dynasty		1993-1988	
	Sonoma		1995-1991		Grand Caravan		1989-1988	
	Sprint		1971		Grand Caravan		1992	
	Syclone		1991		Grand Caravan		2000-1994	
	Typhoon		1993-1992		Mini Ram		1988-1987	
	V1500		1987		Power Ram 50		1983	
	V1500 Suburban		1991-1987		Raider		1989	
	V2500		1987		Ram 50		1983	
	V2500 Suburban		1991-1987		Ram 50		1991-1990	
	V3500		1991-1987		Shadow		1994-1992	
Isuzu	Yukon		1995-1992	Eagle	Spirit		1995-1989	
	Pickup		1994-1991		Stealth		1996-1991	
	Rodeo		1992-1991		Summit		1996-1989	
Jeep	Trooper		1991-1989	Vista			1992-1989	
	Cherokee		1986-1984		Sonata		1998-1990	
	Comanche		1986	Hyundai	3000GT		1998-1997	
Wagoneer		1986-1984	Galant			1988-1985		
Mercury	Cyclone		1971		Mighty Max		1985-1983	
	Oldsmobile	Bravada			1994-1991	Mighty Max		1994-1990
Custom Cruiser			1992		Mirage		1999-1991	
Cutlass Ciera			1986-1982		Montero		1985-1983	
Firenza			1986-1982		Montero		1994-1989	
Omega			1984-1980		Sigma		1990-1989	
Silhouette			1994-1990		Plymouth	Acclaim		1995-1989
Starfire			1977-1976			Arrow		1980-1979
Pontiac	6000		1986-1982	Arrow Pickup			1982-1979	
	Acadian		1987-1976	Caravelle			1985-1983	
	Astre		1977-1976	Colt			1980-1978	
	Bonneville		1986	Colt			1992	
	Fiero		1988-1985	Grand Voyager			1989-1988	
	Firebird		1995-1982	Grand Voyager			2000-1992	
	Grand Prix		1986	Reliant			1985-1981	
	J2000		1983-1982	Sapporo			1983-1978	
	J2000 Sunbird		1985-1984	Sundance			1994-1992	
	Parisienne		1986	Voyager			2000-1984	
	Phoenix		1984-1980	<b>3586 PZFR6J-11 Laser Platinum</b>				
	Sunbird		1977-1976	Qty per Vehicle: 12			Box Qty: 4	
	Sunbird		1986	Audi		A8 Quattro		2009-2005
T1000		1987-1981	Bentley	Continental		2010-2003		
Trans Sport		1995-1990	Volkswagen	Phaeton		2005-2004		
<b>3573</b>		<b>PGR5A-11</b>	<b>Laser Platinum</b>	<b>3587</b>		<b>PLTR6A-10G</b>	<b>Laser Platinum</b>	
Qty per Vehicle: 3-6			Box Qty: 4	Qty per Vehicle: 6-16			Box Qty: 4	
Chrysler	Dynasty		1990-1989	Buick	Allure		2008-2005	
	E Class		1984-1983		Allure		2010	
	Executive Limousine		1985		Enclave		2017-2008	
	Executive Sedan		1984-1983		LaCrosse		2008-2005	
	Grand Voyager		2000		LaCrosse		2016-2010	
	LeBaron		1985-1982		Rendezvous		2006-2004	
	Daihatsu	LeBaron		1995-1990	Cadillac	ATS		2015-2013
		New Yorker		1985-1983		CTS		2015-2004
		New Yorker		1989-1988		SRX		2016-2004
		TC Maserati		1991-1990		STS		2011-2005
		Town & Country		1982		XTS		2017-2013
		Town & Country		1985-1984		Chevrolet	Camaro	
		Voyager		2000	Caprice			2017-2012
Dodge		Charade		1992-1988	Captiva Sport			2012
	400		1983-1982	Colorado			2016-2015	
	600		1985-1983	Equinox			2017-2008	
	Aries		1985-1981	Impala			2017-2012	
	Caravan		2000-1984	Impala Limited			2016-2014	
	Challenger		1983-1978	Malibu		2012-2008		
	Colt		1980-1978	Traverse		2017-2009		
	Colt		1994-1991	Ford	E-350 Super Duty		2017	
	D50		1982-1979		F-150		2014-2010	
	Daytona		1993-1990					



3587 (Cont'd)		PLTR6A-10G	Laser Platinum
Qty per Vehicle: 6-16			Box Qty: 4
Ford	F-250 Super Duty		2017-2011
	F-350 Super Duty		2017-2011
GMC	Acadia		2016-2007
	Acadia Limited		2017
	Canyon		2016-2015
	Terrain		2017-2010
Mazda	6		2013-2009
	CX-9		2015-2007
Pontiac	G6		2009-2007
	G8		2009-2008
	Torrent		2009-2008
Saab	9-4X		2011
Saturn	Aura		2009-2007
	Outlook		2010-2007
	Vue		2010-2008
Suzuki	Grand Vitara		2010-2009
	XL-7		2009-2007
3588		ILFR6A	Laser Iridium
Qty per Vehicle: 4-16			Box Qty: 4
Mercedes-Benz	C230		2005-2003
	CL55 AMG		2006-2003
	CLS55 AMG		2006
	E55 AMG		2006-2003
	G55 AMG		2011-2005
	S55 AMG		2006-2003
	SL55 AMG		2008-2003
	SLR McLaren		2009-2005
3623		BPR6EFS	Standard
Qty per Vehicle: 4			Box Qty: 10
Rover	2000		1971-1968
3656		LZFR6AI	Laser Iridium
Qty per Vehicle: 4			Box Qty: 4
Mitsubishi	Eclipse		2012-2006
	Galant		2012-2004
	Lancer		2006-2004
	Outlander		2006-2004
3657		IZFR5K11	Laser Iridium
Qty per Vehicle: 6			Box Qty: 4
Acura	MDX		2006-2003
Honda	Odyssey		2010-2005
	Pilot		2008-2006
	Ridgeline		2008-2006
Saturn	Vue		2007-2004
3672		LFR6A-11	V-Power
Qty per Vehicle: 6			Box Qty: 4
Subaru	Outback		2004-2001
3686		FR45	V-Power
Qty per Vehicle: 4-8			Box Qty: 4
Buick	Electra		1989-1985
	LeSabre		1990-1985
	Regal		1987-1986
	Riviera		1985
Cadillac	Brougham		1990-1987
	Fleetwood		1986
Chevrolet	Caprice		1990-1986
Chrysler	Cirrus		1997-1995
	Cirrus		2000-1999
	Sebring		1998-1996
	Voyager		2000
Dodge	Caravan		2000-1996
	Grand Caravan		1997-1996
	Stratus		2000-1995
Oldsmobile	Custom Cruiser		1990-1985

3686 (Cont'd)		FR45	V-Power	
Qty per Vehicle: 4-8			Box Qty: 4	
Oldsmobile	Cutlass Salon		1987-1985	
	Cutlass Supreme		1988-1985	
	Delta 88		1985	
	Toronado		1985	
Plymouth	Breeze		2000-1996	
	Grand Voyager		1997-1996	
	Voyager		2000-1996	
Pontiac	Parisienne		1986	
	Safari		1989-1987	
3689		TR6IX	Iridium IX	
Qty per Vehicle: 4-12			Box Qty: 4	
Aston Martin	DB7		2000	
Cadillac	CTS		2015-2009	
Chevrolet	Camaro		2015-2012	
	Corvette		2013-2006	
Ford	Crown Victoria		2005-1996	
	GT		2006-2005	
	Mustang		2014-2007	
	Taurus		2006-1999	
Mercury	Sable		2001	
	Sable		2005-2003	
Pontiac	Firebird		1989	
	Grand Prix		1990-1989	
Rover	2000		1971-1968	
3690		TR7IX	Iridium IX	
Qty per Vehicle: 8			Box Qty: 4	
Cadillac	STS		2009-2006	
	XLR		2009-2006	
3692		TR65IX	Iridium IX	
Qty per Vehicle: 4-12			Box Qty: 4	
Aston Martin	Vanquish		2006-2002	
Ford	Escape		2005	
	F-150		2003-1999	
	Focus		2010-2003	
	Mustang		2004-2003	
	Ranger		2000-1997	
Jaguar	X-Type		2005-2002	
Mazda	3		2005-2004	
	B4000		2000-1997	
3696		BKR6EY	V-Power	
Qty per Vehicle: 6			Box Qty: 4	
Nissan	D21		1994-1990	
	Pathfinder		1995-1990	
	Pickup		1995	
3716		TR5-1GP	G-Power	
Qty per Vehicle: 4-6			Box Qty: 4	
Buick	Century		1996	
	Ford	Aerostar		1987-1986
		E-150		2003
		E-150 Club Wagon		2003
		E-250		2003
		Escort		1990-1983
		EXP		1988-1983
		F-150		2003
		F-150		2007-2005
		F-150 Heritage		2004
		Fairmont		1983
		LTD		1986-1983
		Mustang		1990-1983
		Ranger		1988-1983
		Thunderbird		1984
Mercury	Capri		1986-1983	
	Cougar		1984-1983	



3716 (Cont'd)		TR5-1GP	G-Power	3764		BKR6EIX-11	Iridium IX
Qty per Vehicle: 4-6			Box Qty: 4	Qty per Vehicle: 4-24			Box Qty: 4
Mercury	LN7		1983	Acura	Integra		2001-1992
	Lynx		1987-1982		Legend		1995-1991
	Marquis		1986-1983		NSX		2005-1991
	Zephyr		1983	Aston Martin	DB9		2005
<b>3722</b>		<b>BR5HS</b>	<b>Standard</b>	Audi	A4		2005-2002
Qty per Vehicle: 4-6			Box Qty: 10	A4 Quattro		2006-2002	
Chevrolet	Corvair		1969-1960	A4 Quattro		2009	
	Volkswagen	Beetle	1953-1950	A5 Quattro		2010-2008	
		Transporter	1953-1950	A6		2004-2002	
		Transporter	1972-1967	A6		2011-2009	
<b>3735</b>		<b>BCPR6E</b>	<b>V-Power</b>	A6 Quattro		2006-2002	
Qty per Vehicle: 4-8			Box Qty: 4	Q5		2012-2009	
Aston Martin	Virage		1994-1990	Chevrolet	Aveo		2008-2004
Morgan	4/4		1994-1982		Aveo5		2008-2006
Saab	9-3		2003-1999		Epica		2006-2004
	9-5		2002-2000		Metro		2001-1998
	9-5		2009-2004		Tracker		1991-1989
	900		1998-1985		Tracker		2002-1998
	9000		1990-1986	Chrysler	Crossfire		2006-2005
Toyota	Supra		1992-1987		Sebring		1999-1995
					Sebring		2005-2001
<b>3741</b>		<b>PZFR5F</b>	<b>Laser Platinum</b>	Daewoo	Lanos		2002-1999
Qty per Vehicle: 4-12			Box Qty: 4		Nubira		2002-1999
BMW	750iL		1996-1988	Daihatsu	Charade		1992-1989
	850Ci		1997-1993		Rocky		1992-1990
	850CSi		1995-1994		Dodge	Avenger	
	850i		1992-1991	Colt			1994-1993
Mazda	626		2002-1998	Dakota			2007-2005
	Millenia		2002-1995	Stealth			1996-1991
Saturn	Astra		2009-2008	Stratus			2005-2001
<b>3754</b>		<b>TR4</b>	<b>V-Power</b>	Eagle		Talon	
Qty per Vehicle: 4-6			Box Qty: 4	Ford	Escort		1996-1991
Buick	Century		1989-1987		Probe		1997-1993
	Century		1993	Geo	Storm		1991-1990
	Lucerne		2011-2009	GMC	Tracker		1991-1989
	Regal		1993-1988	Honda	Civic		2000-1999
	Skyhawk		1989-1987		Civic del Sol		1997-1994
		Terraza			2007-2006	CR-Z	
			2007-2006		Passport		1996-1994
Cadillac	Cimarron		1988-1987	Infiniti	G20		1996-1991
Chevrolet	Beretta		1993-1987		M30		1992-1990
	Cavalier		1994-1987	Isuzu	I-Mark		1989
	Celebrity		1990-1987	Impulse		1992-1990	
	Corsica		1993-1987	Rodeo		1995-1993	
	Impala		2011-2006	Rodeo		2003	
	Lumina		1994-1990	Rodeo Sport		2003	
	Malibu		2010-2006	Stylus		1992-1991	
	Monte Carlo		2007-2006	Trooper		1995-1992	
	Uplander		2009-2006	Jaguar	Vanden Plas		2003
Oldsmobile	Cutlass Ciera		1989-1987		XJR		2003-1998
	Cutlass Ciera		1993		XKR		2003
	Cutlass Cruiser		1989-1987	Jeep	Grand Cherokee		2004-2002
	Cutlass Supreme		1993-1988	Kia	Rio		2005-2003
	Firenza		1988-1987		Sportage		2002-1995
Pontiac	6000		1991-1987	Land Rover	Discovery		2004-1999
	G6		2010-2006		Freelander		2005-2002
	Grand Prix		1993-1988	Lexus	ES300		2003-1994
	Montana		2009-2006		ES330		2006-2004
	Sunbird		1994-1991		GS300		1993
	Tempest		1991-1987		GS300		2005-2001
Saturn	Aura		2008-2007		GS400		2000-1998
	Relay		2007-2006		GS430		2007-2001
	Vue		2010-2008		GX470		2009-2003
					HS250h		2012-2010
				IS300		2005-2001	



3764 (Cont'd)	BKR6EIX-11	Iridium IX	
Qty per Vehicle: 4-24		Box Qty: 4	
Lexus	LS400	2000-1990	
	LS430	2006-2001	
	LX470	2007-1998	
	RX300	2003-1999	
	RX330	2006-2004	
	RX400h	2008-2006	
	SC300	1994-1993	
	SC400	2000-1992	
Lotus	Elan	1991	
	Elise	2007-2005	
	Exige	2006	
Mazda	Miata	1993-1990	
	Protege	1994-1990	
Mercedes-Benz	C32 AMG	2004-2003	
	C55 AMG	2006-2005	
	CL600	2002	
	CLK55 AMG	2006-2003	
	S600	2002	
	SLK32 AMG	2004-2003	
	SLK55 AMG	2011-2005	
	SLK230	2004-2003	
Mercury	Capri	1994-1991	
	Tracer	1996-1991	
Mini	Cooper	2008-2007	
Mitsubishi	3000GT	1999-1991	
	Diamante	1995-1992	
	Eclipse	2000-1999	
	Galant	2000-1999	
	Lancer	2017-2011	
	Montero	1996-1995	
	Montero Sport	1998-1997	
	Outlander Sport	2017-2011	
Nissan	RVR	2017-2011	
	200SX	1998-1995	
	Frontier	2004-2001	
	Maxima	1994-1989	
	NX	1993-1991	
	Sentra	1994-1991	
Plymouth	Sentra	1999-1998	
	Xterra	2004-2002	
	Colt	1994-1993	
	Pontiac	Vibe	2006-2003
		Vibe	2010-2009
Wave		2008-2005	
Wave5		2007-2005	
Saab	9-3	2011-2004	
	9-3X	2011-2010	
Scion	tC	2010-2005	
	xB	2012-2008	
Subaru	Baja	2003	
	Forester	2004-1999	
	Impreza	2004-1993	
	Legacy	2003-1990	
	Legacy	2012-2010	
	Outback	2003-2000	
	Outback	2012-2010	
	SVX	1997-1992	
Suzuki	Esteem	2002-1999	
	Grand Vitara	1999	
	Grand Vitara	2008-2006	
	Swift	2001-1995	
	Swift+	2008-2004	
	Verona	2006-2005	
	Vitara	2002-1999	

3764 (Cont'd)	BKR6EIX-11	Iridium IX	
Qty per Vehicle: 4-24		Box Qty: 4	
Suzuki	XL-7	2006-2004	
	Toyota	4Runner	2009-2003
		Avalon	2004-1995
		Camry	2011-1992
		Celica	2005-1991
		Corolla	2006-2005
		Corolla	2012-2009
		Highlander	2010-2001
		Land Cruiser	2007-1998
		Matrix	2006-2003
		Matrix	2012-2009
		MR2	1995-1992
		Previa	1997-1995
		RAV4	2008-1996
		Sequoia	2009-2005
		Sienna	2006-1998
		Solara	2008-1999
		Supra	1998-1993
Tundra	2009-2005		
Volvo	S80	2010-2007	
	XC90	2011-2005	
3784	PTR5D-10	Laser Platinum	
Qty per Vehicle: 4-12		Box Qty: 4	
Aston Martin	DB7	2004	
Buick	Allure	2009-2008	
	LaCrosse	2009-2008	
	Rainier	2007-2004	
Cadillac	CTS	2007-2004	
	Escalade	2000-1999	
	Escalade	2014-2002	
	Escalade ESV	2014-2003	
	Escalade EXT	2013-2002	
	SRX	2006-2004	
	STS	2006-2005	
	XLR	2006-2004	
Chevrolet	Avalanche	2013-2007	
	Avalanche 1500	2006-2002	
	C1500	1999-1998	
	C1500 Suburban	1999-1998	
	C2500	2000-1998	
	C2500 Suburban	1999-1998	
	C3500	2000-1998	
	Camaro	2002-1998	
	Camaro	2015-2010	
	Caprice	2017-2011	
	Cavalier	2002-1999	
	Colorado	2012-2009	
	Corvette	2013-1997	
	Express 1500	2014-1998	
	Express 2500	2017-1998	
	Express 3500	2017-1998	
	Express 4500	2016-2009	
Impala	2009-2006		
K1500	1999-1998		
K1500 Suburban	1999-1998		
K2500	2000-1998		
K2500 Suburban	1999-1998		
K3500	2000-1998		
Monte Carlo	2007-2006		
P30	1999-1998		
S10	2001-1999		
S10	2003		
Silverado 1500	2013-1999		
Silverado 1500 Classic	2007		
Silverado 1500 HD	2003-2001		



3784 (Cont'd)	PTR5D-10	Laser Platinum	3785	BPR7ES SOLID	Standard
Qty per Vehicle: 4-12		Box Qty: 4	Qty per Vehicle: 4		Box Qty: 4
Chevrolet	Silverado 1500 HD	2006-2005	Honda	Civic	1979-1978
	Silverado 1500 HD Classic	2007	<b>3787 ILTR6A-8G Laser Iridium</b>		
	Silverado 2500	2004-1999	Qty per Vehicle: 4		Box Qty: 4
	Silverado 2500 HD	2017-2001	Mazda	3	2009-2007
	Silverado 2500 HD Classic	2007		6	2007-2006
	Silverado 3500	2006-2001		CX-7	2009-2007
	Silverado 3500 Classic	2007	<b>3903 BPR6EIX-11 Iridium IX</b>		
	Silverado 3500 HD	2017-2007	Qty per Vehicle: 3-6		Box Qty: 4
	SS	2017-2014	Chevrolet	Metro	1992
	SSR	2006-2003		Metro	2000-1998
	Suburban 1500	2014-2000		Sprint	1992-1987
	Suburban 2500	2013-2000	Chrysler	Conquest	1988-1987
	Suburban 3500 HD	2017-2016	Dodge	2000 GTX	1990-1989
	Tahoe	2014-1998		Challenger	1979-1978
	Trailblazer	2009-2006		Colt	1991-1979
	Trailblazer EXT	2006-2003		Conquest	1986-1984
	Ford	Mustang		1993-1991	D50
Ranger		1993-1989		Mini Ram	1986-1984
GMC	C1500	1999-1998		Power Ram 50	1986-1983
	C1500 Suburban	1999-1998		Raider	1989-1987
	C2500	2000-1998		Ram 50	1993-1983
	C2500 Suburban	1999-1998		Eagle	2000 GTX
	C3500	2000-1998	Summit		1990-1989
	Canyon	2012-2009	Talon		1994-1990
	Envoy	2009-2005	Ford	Aspire	1997-1994
	Envoy XL	2006-2003		Festiva	1993-1988
	Envoy XUV	2005-2004	Geo	Metro	1997-1989
	K1500	1999-1998		Storm	1993-1990
	K1500 Suburban	1999-1998	Honda	Accord	1985
	K2500	2000-1998		Civic	1987-1985
	K2500 Suburban	1999-1998		Prelude	1987-1984
	K3500	2000-1998	Hyundai	Elantra	1995-1992
	P3500	1999-1998		Excel	1994-1986
	Savana 1500	2014-1998		Scoupe	1992-1991
	Savana 2500	2017-1998		Sonata	1998-1989
	Savana 3500	2017-1998	Isuzu		1989
	Savana 4500	2016-2009		Amigo	
	Sierra 1500	2013-1999		I-Mark	1989-1981
	Sierra 1500 Classic	2007		Impulse	1989-1983
	Sierra 1500 HD	2003-2001		Pickup	1991-1981
	Sierra 1500 HD	2006-2005		Stylus	1993-1991
	Sierra 1500 HD Classic	2007	Trooper	1987-1984	
	Sierra 2500	2004-1999	Mazda	Mizer	1976
	Sierra 2500 HD	2017-2001	Mitsubishi	Cordia	1988-1983
	Sierra 2500 HD Classic	2007		Diamante	1996-1992
	Sierra 3500	2006-2001		Eclipse	1994-1990
	Sierra 3500 Classic	2007		Expo	1992
	Sierra 3500 HD	2017-2007		Galant	1992-1989
	Sonoma	2003-1998		Galant	1994
	Yukon	2014-1998		Mighty Max	1996-1983
	Yukon XL 1500	2014-2000		Mirage	1992-1985
Yukon XL 2500	2013-2000	Montero		1989-1986	
Hummer	H2	2009-2003		Precis	1994-1987
	H3	2010-2008		Starion	1988-1983
	H3T	2010-2009		Tredia	1988-1983
Isuzu	Ascender	2006-2003	Van	1990-1987	
	Hombre	2000-1998	Nissan	200SX	1979-1977
Panoz	Esperante	2005-2003		280ZX	1983-1980
	Pontiac	Firebird		2002-1998	510
G8		2009-2008		610	1976-1975
Grand Prix		2008-2005		710	1977-1975
GTO		2006-2004		810	1981-1980
Sunfire		2002-1999		Maxima	1984-1981
Saab	9-7x	2009-2005		Pulsar NX	1984-1983
				Sentra	1988-1987





3903 (Cont'd)		BPR6EIX-11	Iridium IX	3951 (Cont'd)		TR55	V-Power
Qty per Vehicle: 3-6			Box Qty: 4	Qty per Vehicle: 4-12			Box Qty: 4
Nissan	Stanza		1983-1982	Buick	LaCrosse		2009-2005
Plymouth	Arrow		1980-1978		LeSabre		2005-1988
	Arrow Pickup		1982-1979		Lucerne		2011-2006
	Champ		1982-1979		Park Avenue		2005-1991
	Colt		1979-1976		Reatta		1991-1988
	Colt		1994-1981		Regal		2004-1990
	Conquest		1986-1984		Rendezvous		2007-2002
	Horizon		1983		Riviera		1993-1988
	Laser		1994-1990		Riviera		1999-1995
	Sapporo		1979-1978		Roadmaster		1996-1994
Turismo		1983	Skylark		1998-1989		
Pontiac	Firefly		1991-1987	Cadillac	Terraza		2006-2005
	Firefly		2000-1994		60 Special		1993
Subaru	Brat		1987-1981		Allante		1993-1987
	DL		1989-1980		Commercial Chassis		1996-1985
	GL		1989-1980		DeVille		2005-1982
	GL-10		1989-1985		DTS		2011-2006
	GLF		1982-1980		Eldorado		2002-1982
	Justy		1990-1987		Fleetwood		1992-1982
	Justy		1995		Fleetwood		1996-1994
	Loyale		1994-1990		Seville		2004-1982
	RX		1989-1986	SRX		2009-2007	
Standard		1987-1976	STS		2010-2007		
Suzuki	Swift		1994-1989	Chevrolet	XLR		2009-2007
					Astro		2005-1996
<b>3922</b>		<b>BR6HS</b>	<b>Standard</b>		Avalanche 2500		2006-2002
Qty per Vehicle: 4-6			Box Qty: 10		Beretta		1996-1994
Aston Martin	DB		1959-1957		Blazer		2005-1996
	DB2-4		1957-1953		C1500		1999-1996
	DB3		1956-1953		C1500 Suburban		1997-1996
	DBD		1959-1958		C2500		1993-1992
Chevrolet	Corvair		1965-1962		C2500		2000-1996
Volkswagen	Beetle		1979-1954		C2500 Suburban		1999-1996
	Campmobile		1971-1968	C3500		2000-1996	
	Fastback		1973-1966	C3500HD		2002-2001	
	Karmann Ghia		1974-1956	C4500 Kodiak		2009-2008	
	Squareback		1973-1966	C5500 Kodiak		2009-2008	
	Super Beetle		1980-1971	C6500 Kodiak		2009-2008	
	Thing		1974-1973	C7500 Kodiak		2009-2008	
	Transporter		1966-1954	Camaro		2002-1993	
<b>3923</b>		<b>BPR8ES</b>	<b>Standard</b>	Caprice		1996-1994	
Qty per Vehicle: 6-12			Box Qty: 4	Cavalier		2002-1995	
Ferrari	275 GT		1968	Corsica		1996-1994	
	275 GTB		1968-1964	Corvette		1996-1992	
	512 BB		1981-1977	Equinox		2009-2005	
	Dino 206 GT		1969-1968	Express 1500		2014-1996	
	Dino 246 GT		1973-1969	Express 2500		2005-1996	
	Dino 246 GTS		1973-1972	Express 3500		2002-1996	
Maserati	430i		1990-1989	G30		1995	
	Biturbo		1987-1983	Impala		1996-1994	
Porsche	911		1977-1970	Impala		2005-2000	
	911		1989-1981	K1500		1999-1996	
	930		1979-1978	K1500 Suburban		1997-1996	
<b>3932</b>		<b>DCPR7E</b>	<b>Standard</b>	K2500		1993-1992	
Qty per Vehicle: 4			Box Qty: 10	K2500		2000-1996	
Chevrolet	Spark		2015-2013	K2500 Suburban		1999-1996	
Fiat	500		2017-2014	K3500		2000-1996	
<b>3951</b>		<b>TR55</b>	<b>V-Power</b>	Lumina		2001-1995	
Qty per Vehicle: 4-12			Box Qty: 4	Lumina APV		1996-1992	
Aston Martin	DB7		2003-2002	Malibu		2006-1997	
Buick	Allure		2009-2005	Monte Carlo		2005-1995	
	Century		2005-1989	P30		1999-1996	
	Commercial Chassis		1996-1994	S10		2004-1996	
	Electra		1990-1988	Silverado 1500		2013-1999	
				Silverado 1500 Classic		2007	



3951 (Cont'd)	TR55	V-Power	3951 (Cont'd)	TR55	V-Power
Qty per Vehicle: 4-12		Box Qty: 4	Qty per Vehicle: 4-12		Box Qty: 4
Chevrolet	Silverado 2500 HD	2006-2001	GMC	Jimmy	2005-1996
	Silverado 2500 HD Classic	2007		K1500	1999-1996
	Silverado 3500	2006-2001		K1500 Suburban	1997-1996
	Silverado 3500 Classic	2007		K2500	2000-1996
	Suburban 2500	2006-2001		K2500 Suburban	1999-1996
	Tahoe	1997-1996		K3500	2000-1996
	Uplander	2006-2005		P3500	1999-1996
Ford	Venture	2005-1997		Safari	2005-1996
	Aerostar	1997-1990		Savana 1500	2014-1996
	Contour	2000-1995		Savana 2500	2005-1996
	Crown Victoria	2011-1992		Savana 3500	2002-1996
	E-150	2014-2003		Sierra 1500	2013-1999
	E-150 Club Wagon	2005-2003		Sierra 1500 Classic	2007
	E-150 Econoline	2002-1997		Sierra 2500 HD	2006-2001
	E-150 Econoline Club Wagon	2002-1997		Sierra 2500 HD Classic	2007
	E-250	2014-2003		Sierra 3500	2006-2001
	E-250 Econoline	2002-1997		Sierra 3500 Classic	2007
	E-350 Club Wagon	2005-2003	Sonoma	2004-1996	
	E-350 Econoline	1998-1997	Yukon	1997-1996	
	E-350 Econoline Club Wagon	2002-1997	Yukon XL 2500	2006-2001	
	E-350 Super Duty	2017-1999	Isuzu	Hombre	1999-1997
	E-450 Econoline Super Duty	2002-1999	Lincoln	Aviator	2005-2003
	E-450 Super Duty	2017-2003		Blackwood	2002
	E-550 Econoline Super Duty	2002		Continental	2002-1995
	E-550 Super Duty	2003		LS	2005-2000
	Econoline Super Duty	1999-1997		Mark VIII	1998-1993
	Escape	2008-2001		Navigator	2004-1998
	Excursion	2005-2000		Town Car	2008-1991
	Expedition	2004-1997		Town Car	2011
	Explorer	2005-1991	Zephyr	2006	
	Explorer Sport	2003-2001	Mazda	5	2007-2006
	Explorer Sport Trac	2005-2001		6	2005-2003
	F53	2004-1999		B3000	2008-2004
	F-150	2009-1997		B4000	1996-1994
	F-150 Heritage	2004		B4000	2003
	F-250	1999-1997		MPV	2006-2002
	F-250 Super Duty	2004-1999		Navajo	1994-1991
	F-350 Super Duty	2004-1999		Tribute	2006-2001
	F-450 Super Duty	2004-1999	Tribute	2008	
	F-550 Super Duty	2004-1999	Mercury	Cougar	1997-1994
	Fiesta	1979-1978		Cougar	2002-1999
	Five Hundred	2007-2005		Grand Marquis	2011-1992
	Focus	2011		Marauder	2004-2003
	Freestar	2005-2004		Mariner	2008-2005
	Freestyle	2007-2005		Milan	2009-2006
	Fusion	2009-2006		Montego	2007-2005
	Mustang	2004-1993		Mountaineer	2006-1997
	Ranger	1996-1990	Mystique	2000-1995	
	Ranger	2008	Sable	2005-1996	
	Ranger	2011-2010	Topaz	1994-1989	
Taurus	2005-1996	Oldsmobile	88	1999-1992	
Tempo	1994-1989		98	1996-1988	
Thunderbird	1997-1994		Achieva	1998-1992	
Transit Connect	2013-2010		Alero	2004-1999	
Windstar	2003-1996		Aurora	1999-1995	
GMC	C1500		1999-1996	Aurora	2003-2001
	C1500 Suburban		1997-1996	Bravada	2001-1996
	C2500		2000-1996	Cutlass	1999-1997
	C2500 Suburban		1999-1996	Cutlass Calais	1991-1989
	C3500		2000-1996	Cutlass Ciera	1996-1989
	C3500HD		2002-1996	Cutlass Cruiser	1994-1989
	C4500 Topkick		2009-2008	Cutlass Supreme	1997-1993
	C5500 Topkick		2009-2008	Delta 88	1991-1988
	C6500 Topkick		2009-2008	Intrigue	2002-1998
	C7500 Topkick	2009-2008	LSS	1999-1996	



3951 (Cont'd)	TR55	V-Power
Qty per Vehicle: 4-12		Box Qty: 4
Oldsmobile	Regency	1998-1997
	Silhouette	2004-1992
	Toronado	1992-1988
Pontiac	Aztek	2005-2001
	Bonneville	2005-1988
	Firebird	2002-1993
	G6	2006-2005
	Grand Am	2005-1992
	Grand Prix	2008-1994
	Montana	2006-1999
	Sunfire	2002-1995
	Torrent	2009-2006
Saturn	Trans Sport	1999-1992
	Relay	2006-2005
3964	BKR5EKU	Standard
Qty per Vehicle: 6		Box Qty: 4
Volkswagen	Corrado	1995-1992
	EuroVan	1997
	EuroVan	2001-1999
	EuroVan	2003
	Golf	1999-1995
	Golf	2002-2001
	Jetta	2002-1994
	Passat	1997-1993
3967	BKR5EKB-11	Standard
Qty per Vehicle: 4-6		Box Qty: 4
Chevrolet	Prizm	1999-1998
Lexus	GS300	2000-1998
	SC300	2000-1999
Toyota	4Runner	2002-1996
	Corolla	1999-1998
	Paseo	1999-1995
	Supra	1998
	T100	1998-1995
	Tacoma	2004-1995
	Tercel	1999-1995
	Tundra	2004-2000
3971	BPR5EP-11	Laser Platinum
Qty per Vehicle: 3-6		Box Qty: 4
Chevrolet	Nova	1988-1985
	Sprint	1992-1989
Chrysler	Daytona	1993-1990
	Dynasty	1988
Dodge	Colt	1991
	Colt	1995
	Grand Caravan	1987
	Grand Caravan	1993
	Mini Ram	1988
Eagle	Vista	1989-1988
Honda	Accord	1989-1986
	Civic	1973
	Passport	1996-1994
	Prelude	1987-1985
Isuzu	Amigo	1994-1989
	Pickup	1995-1992
	Rodeo	1997-1991
	Trooper	1991-1988
Kia	Sephia	1995-1994
Mazda	323	1995-1986
	B2200	1993-1990
	B2600	1988-1987
Mitsubishi	3000GT	1999
Nissan	210	1982-1979
	280Z	1978-1977

3971 (Cont'd)	BPR5EP-11	Laser Platinum	
Qty per Vehicle: 3-6		Box Qty: 4	
Nissan	280ZX	1980-1979	
	310	1982-1979	
	810	1979-1977	
	B210	1978-1977	
	F10	1978-1977	
	Micra	1991-1984	
	Pulsar	1983	
	Pulsar NX	1988-1983	
	Sentra	1986-1982	
	Stanza	1983-1982	
	Plymouth	Colt	1991
		Grand Voyager	1987
		Grand Voyager	1999-1995
		Voyager	1998-1997
Toyota	Camry	1986-1983	
	Celica	1986-1982	
	Corolla	1988-1980	
	Cressida	1988-1982	
	Land Cruiser	1978-1975	
	Land Cruiser	1992-1990	
	Starlet	1984-1983	
	Tercel	1994-1981	
	Van	1989-1984	
	4006	BPR5ES SOLID	Standard
Qty per Vehicle: 3-8		Box Qty: 4	
Buick	Skyhawk	1987-1982	
Chevrolet	Bel Air	1969-1961	
	Biscayne	1969-1961	
	C10 Pickup	1969-1968	
	C10 Suburban	1969-1968	
	C20 Pickup	1969-1968	
	C20 Suburban	1969-1968	
	C30 Pickup	1969-1968	
	Camaro	1969-1967	
	Caprice	1969-1966	
	Chevelle	1969-1966	
	Chevy II	1968	
	Corvette	1969-1966	
	El Camino	1970-1966	
	Impala	1969-1961	
	K10 Pickup	1969-1968	
	K10 Suburban	1969-1968	
	K20 Pickup	1969-1968	
	K30 Pickup	1969-1968	
	Malibu	1967-1966	
	Nova	1970	
S10	1985-1982		
S10 Blazer	1984-1983		
Spectrum	1988-1985		
Sprint	1988-1985		
Dodge	Charger	1967	
	Coronet	1971-1967	
	Polara	1966	
Ford	Courier	1979-1972	
	Courier	1981	
	Mustang II	1976-1974	
	Pinto	1973-1971	
	Pinto	1976-1975	
Geo	Spectrum	1989	
GMC	C15/C1500 Pickup	1969-1968	
	C15/C1500 Suburban	1968	
	C25/C2500 Pickup	1969-1968	
	C25/C2500 Suburban	1968	
	C35/C3500 Pickup	1969-1968	
K15/K1500 Pickup	1969-1968		



4006 (Cont'd)		BPR5ES SOLID	Standard	4055 (Cont'd)		BPR7EIX	Iridium IX	
Qty per Vehicle: 3-8			Box Qty: 4	Qty per Vehicle: 4-12			Box Qty: 4	
GMC	K15/K1500 Suburban		1968	Ferrari	308 GTB		1980-1975	
	K25/K2500 Pickup		1969-1968		308 GTB		1984-1982	
	K25/K2500 Suburban		1968		308 GTBi		1982-1981	
	K35/K3500 Pickup		1969-1968		308 GTS		1980-1977	
	S15		1985-1982		308 GTS		1984-1982	
International	S15 Jimmy		1984-1983		308 GTSi		1982-1981	
	100		1974		365 GT		1970-1968	
	200		1974		365 GT4		1976-1973	
	1010		1973-1972		365 GT4 BB		1974	
	1110		1973-1972		365 GTB/4		1974-1968	
	1210		1973-1972		365 GTC		1970-1968	
	1310		1973-1972		365 GTC/4		1972-1971	
	M800 Post Office		1972	365 GTS		1970-1968		
	M1100		1972	365 GTS/4		1974-1970		
	M1200		1972	Dino 308 GT4		1979-1973		
Plymouth	MHC1310		1974	GTO		1987-1984		
	MS1210		1974-1972	Fiat	850	1973-1967		
	Belvedere		1966	Honda	Civic	1979-1978		
	Cuda		1971-1970	Lamborghini	350GT		1966-1964	
Fury		1966-1963	400GT			1968-1966		
Satellite		1967-1965	Countach			1976-1974		
Pontiac	Firefly		1988-1985		Countach		1982-1981	
	Grand Am		1989-1987		Espada		1978-1968	
	J2000		1983-1982		Islero		1970-1968	
	J2000 Sunbird		1985-1984	Jarama		1976-1970		
	Sunbird		1990-1986	Miura		1972-1966		
	Sunbird		1994-1992	Lotus	Elan		1975-1962	
Sunburst		1988-1985	Esprit			1991-1989		
<b>4014 PFR6B-11 Laser Platinum</b>			Europa			1975-1967		
Qty per Vehicle: 4-6			Box Qty: 4		Seven		1975-1969	
Infiniti	G20		1996-1991	Maserati	228i		1990-1989	
	M30		1992-1990		425		1987-1986	
Nissan	200SX		1998-1995		Biturbo		1987	
	Maxima		1994-1989		Mistral		1970-1968	
	NX		1993-1991		Spyder		1987-1986	
	Sentra		1994-1991		Spyder		1991-1989	
	Sentra		1999-1998	Mercedes-Benz	300SL		1959-1954	
Subaru	Impreza		1997-1993	Mitsubishi	Cordia		1988-1984	
	Legacy		1994-1990		Lancer		2005-2003	
	SVX		1997-1992		Mirage		1988-1985	
<b>4043 ZFR4F-11 V-Power</b>			Starion			1989		
Qty per Vehicle: 4-12			Box Qty: 4		Tredia		1988-1984	
BMW	750iL		1998-1997	Peugeot	304		1972-1971	
Honda	Civic		2000-1992	Plymouth	Colt		1986-1984	
<b>4045 PFR6A-11 Laser Platinum</b>			Box Qty: 4	Porsche	911		1977-1969	
Qty per Vehicle: 4			Box Qty: 4		911		1983-1980	
Nissan	Pulsar NX		1989-1987		924		1982-1977	
<b>4055 BPR7EIX Iridium IX</b>			Box Qty: 4		944		1989	
Qty per Vehicle: 4-12			Box Qty: 4	<b>4085 BPR6HIX Iridium IX</b>			Box Qty: 4	
Alfa Romeo	164		1993-1991	Buick	Skylark		1962-1961	
	Berlina		1971-1969	Citroen	D21		1972-1968	
	Duetto 1600		1968-1967		DS21		1972-1968	
	Giulia		1967-1964		DS21 Pallas		1972-1968	
	Giulia Sprint		1968-1967		D Special		1972-1970	
	GTC		1964		ID19		1970-1968	
	Audi	GTV		1968-1967	Mercedes-Benz	190B		1962-1960
		GT Veloce		1974-1969		190C		1965-1963
		Milano		1989-1987		190SL		1963-1960
		Spider		1994-1969		220		1965-1960
100 Series			1977-1972	220S			1965-1960	
5000			1985-1984	220SE		1966-1960		
Chrysler	Quattro		1986-1983	Oldsmobile	Cutlass		1963-1962	
	Conquest		1989		Jetfire		1962	
Dodge	Colt		1990-1984	Opel	1900		1975-1971	



4085 (Cont'd)	BPR6HIX	Iridium IX
Qty per Vehicle: 4-8		Box Qty: 4
Opel	Deluxe	1971
	Kadett	1972-1967
	Manta	1975-1971
	Opel	1973-1969
	Rallye	1970-1968
Porsche	356A	1959-1955
	356B	1963-1960
	356C	1965-1964
	356SC	1965-1964
	Carrera	1959-1958
Renault	LeCar	1978-1977
	R5	1976
	R8	1966-1963
	R10	1969-1967
Saab	95	1968
	96	1968-1967
	Monte Carlo	1967
Triumph	Spitfire	1967-1963
	TR3A	1961-1960
	TR3B	1962
	TR4	1964-1962
	TR4A	1967-1965
Volvo	122	1966-1959
	142	1974-1969
	144	1974-1969
	145	1974-1969
	164	1975-1970
	242	1975
	244	1975
	245	1975
	445	1960-1959
	544	1965-1959
	1800	1965-1961
	1800	1968
	1800	1973

4095	IZFR6F11	Laser Iridium
Qty per Vehicle: 4-8		Box Qty: 4
Acura	CL	2003-2001
	TL	2003-2002
Chevrolet	Aveo	2011-2009
	Aveo5	2011-2009
Dodge	B2500	1998
	B3500	1998-1997
	Durango	2002-2000
	Ram 1500	2002
	Ram 2500 Van	2000-1999
	Ram 3500 Van	2000-1999
Jeep	Grand Cherokee	1999
	Grand Cherokee	2004-2002
Mazda	Protege	2003
Pontiac	G3	2009

4115	PFR6G-13	Laser Platinum
Qty per Vehicle: 4		Box Qty: 4
Acura	Integra	2001-1992

4177	TR6	V-Power
Qty per Vehicle: 4-12		Box Qty: 4
Aston Martin	DB7	2000
Cadillac	CTS	2015-2009
Chevrolet	Camaro	2015-2012
	Corvette	2013-2006
Ford	Crown Victoria	2005-1996
	Escape	2005
	F-150	2003-1999
	Focus	2010-2003

4177 (Cont'd)	TR6	V-Power
Qty per Vehicle: 4-12		Box Qty: 4
Ford	GT	2006-2005
	Mustang	2004-2003
	Mustang	2014-2007
	Ranger	2000-1997
	Taurus	2006-1999
Mazda	3	2005-2004
	B4000	2000-1997
Mercury	Sable	2001
	Sable	2005-2003
Pontiac	Firebird	1989
	Grand Prix	1990-1989
Rover	2000	1971-1968

4213	IZTR4A11	Laser Iridium
Qty per Vehicle: 4-6		Box Qty: 4
Buick	Lucerne	2011-2009
	Terraza	2007-2006
Chevrolet	Cavalier	1999
	Impala	2011-2006
	Malibu	2010-2006
	Monte Carlo	2007-2006
	Uplander	2009-2006
Pontiac	G6	2010-2006
	Montana	2009-2006
Saturn	Aura	2008-2007
	Relay	2007-2006
	Vue	2010-2008

4218	CR8EIX	Iridium IX
Qty per Vehicle: 8		Box Qty: 4
Ferrari	F355 Berlinetta	1996-1994

4259	PMR7A	Laser Platinum
Qty per Vehicle: 8-12		Box Qty: 4
Ferrari	F50	1997-1995
	F355	1999
	F355 F1	1998
	F355 GTS	1998-1994
	F355 Spider	1999-1996

4268	GR45	V-Power	
Qty per Vehicle: 4-8		Box Qty: 4	
Asuna	GT	1993	
	SE	1993	
Buick	Skyhawk	1988-1987	
Cadillac	Calais	1976-1975	
	Commercial Chassis	1984-1975	
	DeVille	1981-1975	
	Eldorado	1978-1975	
	Eldorado	1981-1980	
	Fleetwood	1984-1975	
	Seville	1981-1980	
	Chrysler	Concorde	1996-1993
		Dynasty	1993-1990
		Grand Voyager	2000
Imperial		1993-1990	
Intrepid		1997-1993	
New Yorker		1993-1990	
Town & Country		2000-1990	
Voyager		2000	
Dodge		Caravan	2000-1990
		Dynasty	1993-1990
	Grand Caravan	2000-1990	
	Intrepid	1997-1993	
	Vision	1997-1993	
Oldsmobile	Firenza	1988-1987	
Plymouth	Grand Voyager	2000-1990	
	Voyager	2000-1991	





4268 (Cont'd)		GR45	V-Power
Qty per Vehicle: 4-8			Box Qty: 4
Pontiac	LeMans		1993-1988
	Optima		1991-1988
	Sunbird		1988-1987
4285		BKR7EQUP	Laser Platinum
Qty per Vehicle: 6			Box Qty: 4
Porsche	911		2008-2003
	Boxster		2008-2005
	Cayman		2008-2006
4288		PLKR7A	Laser Platinum
Qty per Vehicle: 6-8			Box Qty: 4
Dodge	Sprinter 2500		2008-2007
	Sprinter 3500		2008-2007
Freightliner	Sprinter 2500		2008-2007
	Sprinter 3500		2008-2007
Mercedes-Benz	C230		2009-2006
	C250		2012-2010
	C280		2007-2006
	C300		2012-2008
	C350		2011-2006
	CL550		2010-2007
	CLK350		2009-2006
	CLK550		2009-2007
	CLS550		2011-2007
	E280		2007
	E300		2009-2008
	E350		2011-2006
	E550		2011-2007
	G550		2015-2009
	GL450		2012-2007
	GL550		2012-2008
	GLK350		2012-2010
	ML350		2011-2006
	ML450		2011-2010
	ML500		2006-2005
	ML550		2011-2008
	R350		2011-2006
	S350		2006
	S400		2013-2010
	S450		2011-2008
	S550		2011-2007
	SL550		2012-2007
	SLK280		2008-2006
SLK300		2011-2009	
SLK350		2011-2005	
4291		ZFR6F-11	V-Power
Qty per Vehicle: 4-8			Box Qty: 4
Acura	CL		2003-2001
	EL		2005-2004
	TL		2003-2002
BMW	550i		2010-2006
	650i		2010-2006
	750i		2008-2006
	750Li		2008-2006
	X5		2010-2004
Dodge	B1500		1998-1997
	B2500		1998-1997
	B3500		1998-1997
	Colt		1992
	Dakota		2003-1997
	Durango		2003-1998
	Ram 1500		2003-1997
	Ram 1500 Van		2003-1999
	Ram 2500		2002-1998
	Ram 2500 Van		2003-1999

4291 (Cont'd)		ZFR6F-11	V-Power
Qty per Vehicle: 4-8			Box Qty: 4
Dodge	Ram 3500		2002-1998
	Ram 3500 Van		2003-1999
Ford	Probe		1997-1989
Honda	Civic		2005-2001
	CR-V		2001-1999
	Prelude		2001-1992
Mazda	626		1992-1990
	MX-6		1992-1990
	Protege		2003
Plymouth	Colt		1992
4292		PFR5R-11	Laser Platinum
Qty per Vehicle: 4-24			Box Qty: 4
Chrysler	Crossfire		2008-2004
Hyundai	Sonata		2006
Kia	Magentis		2008-2007
	Optima		2008-2006
Mercedes-Benz	C43 AMG		2000-1998
	C240		2005-2001
	C280		2000-1998
	C320		2005-2001
	CL55 AMG		2002-2001
	CL500		2006-1998
	CL600		1999-1998
	CL600		2001
	CLK55 AMG		2002-2001
	CLK320		2005-1998
	CLK430		2003-1999
	CLK500		2006-2003
	CLS500		2006
	E55 AMG		2002-1999
	E320		2005-1998
	E430		2002-1998
	E500		2006-2003
	G55 AMG		2004-2003
	G500		2008-2002
	ML55 AMG		2003-2000
	ML320		2003-1998
	ML350		2005-2003
	ML430		2001-1999
	ML500		2004-2002
	ML500		2007
	R500		2007-2006
	S55 AMG		2002-2001
	S420		1999-1998
S430		2006-2000	
S500		2006-1998	
S600		1999-1998	
S600		2001	
SL500		2006-1998	
SL600		2002-1998	
SLK320		2004-2001	
4293		BKR6EZB	V-Power
Qty per Vehicle: 4			Box Qty: 10
Mercedes-Benz	B200		2011-2006
4294		IZFR6H11	Laser Iridium
Qty per Vehicle: 8			Box Qty: 4
BMW	550i		2010-2006
	650i		2010-2006
	750i		2008-2006
	750Li		2008-2006
	X5		2010-2004
4302		BKR5EKPB-11	Laser Platinum
Qty per Vehicle: 4-6			Box Qty: 4
Chevrolet	Prizm		1999-1998



4302 (Cont'd)	BKR5EKP11	Laser Platinum
Qty per Vehicle: 4-6		Box Qty: 4
Lexus	GS300	2000-1998
	SC300	2000-1999
Toyota	4Runner	2002-1996
	Corolla	1999-1998
	Paseo	1999-1995
	Supra	1998
	T100	1998-1995
	Tacoma	2004-1995
	Tercel	1999-1995
	Tundra	2004-2000

4306	LZTR5A-13	V-Power
Qty per Vehicle: 4-16		Box Qty: 4
Chrysler	300	2010-2005
	Concorde	2004-1998
	Intrepid	2004-1998
	Pacifica	2008-2005
	PT Cruiser	2009-2003
	Sebring	2010-2001
	Town & Country	2010-2001
	Voyager	2003-2001
Dodge	Avenger	2010-2008
	Caravan	2007-2001
	Challenger	2010-2008
	Charger	2010-2006
	Grand Caravan	2010-2001
	Intrepid	2004-1998
	Magnum	2008-2005
	Neon	2005-2003
	Stratus	2006-2001
	Viper	2010-2008
	Viper	2017-2015
Jeep	Grand Cherokee	2010-2006
	Wrangler	2011-2007
SRT	Viper	2014-2013
Volkswagen	Routan	2010-2009

4339	DCPR8E	Standard
Qty per Vehicle: 6-12		Box Qty: 10
BMW	M3	2006-2001
	Z3	2002-2001
	Z4	2008-2006
Lamborghini	Diablo	1990

4344	LTR5IX-11	Iridium IX
Qty per Vehicle: 4-8		Box Qty: 4
Buick	Allure	2010
	Envision	2017
	LaCrosse	2016-2010
	Rainier	2007-2004
	Regal	2017-2011
	Verano	2017-2012
Cadillac	ATS	2017-2013
	Escalade	2017-2015
	Escalade ESV	2017-2015
Chevrolet	Camaro	2017-2016
	Captiva Sport	2015-2012
	Cavalier	2005-2002
	Classic	2005-2004
	Cobalt	2010-2005
	Colorado	2012-2004
	Colorado	2016-2015
	Corvette	2017-2014
	Equinox	2017-2010
	HHR	2011-2006
	Impala	2017-2014
	Malibu	2015-2004

4344 (Cont'd)	LTR5IX-11	Iridium IX
Qty per Vehicle: 4-8		Box Qty: 4
Chevrolet	Malibu Limited	2016
	Orlando	2014-2012
	Silverado 1500	2017-2014
	Suburban	2017-2015
	Tahoe	2017-2015
	Trailblazer	2009-2002
	Trailblazer EXT	2006-2002
Ford	C-Max	2017-2013
	Contour	2000-1995
	Edge	2011-2007
	Escape	2004-2001
	Escape	2017-2009
	Escort	2003-1998
	Flex	2012-2009
	Focus	2004-2000
	Fusion	2018-2006
	Taurus	2012-2008
	Taurus X	2009-2008
	Transit Connect	2017-2014
GMC	Acadia	2017
	Canyon	2012-2004
	Canyon	2016-2015
	Envoy	2009-2002
	Envoy XL	2006-2002
	Envoy XUV	2005-2004
	Sierra 1500	2017-2014
	Terrain	2017-2010
	Yukon	2017-2015
	Yukon XL	2017-2015
Hummer	H3	2010-2006
	H3T	2010-2009
Isuzu	Ascender	2008-2003
	i-280	2006
	i-290	2008-2007
	i-350	2006
	i-370	2008-2007
Lincoln	MKS	2013-2009
	MKT	2012-2010
	MKX	2010-2007
	MKZ	2017-2007
Mazda	3	2013-2006
	3 Sport	2010-2009
	3 Sport	2013-2012
	5	2010-2008
	5	2015-2012
	6	2013-2006
	CX-7	2012-2010
	Tribute	2004-2001
Mercury	Tribute	2011-2009
	Cougar	2002-1999
	Mariner	2011-2009
	Milan	2011-2006
	Mystique	2000-1995
Oldsmobile	Sable	2009-2008
	Alero	2004-2002
Bravada	Bravada	2004-2002
	Pontiac	G5
Pontiac	G6	2010-2006
	Grand Am	2005-2002
	Pursuit	2006-2005
	Solstice	2009-2006
	Sunfire	2005-2002
	Saab	9-5
9-7X		2009-2005
Saturn	Aura	2010-2007



4344 (Cont'd)		LTR5IX-11	Iridium IX	4469 (Cont'd)		LFR5AIX-11	Iridium IX	
Qty per Vehicle: 4-8		Box Qty: 4		Qty per Vehicle: 3-16		Box Qty: 4		
Saturn	Ion	2007-2003		Chrysler	Aspen	2009-2008		
	L100	2002-2001			Dodge	Challenger	2017-2009	
	L200	2003-2001				Charger	2017-2009	
	L300	2004				Dakota	2010-2008	
	LS	2000				Dart	2016-2013	
	LS1	2000				Durango	2009-2008	
	LW1	2000				Durango	2017-2011	
	LW200	2003-2001				Ram 1500	2010-2008	
Sky	2010-2007		Ram 2500			2010-2009		
Vue	2010-2002		Ram 3500			2009		
<b>4363</b>		<b>PZFR5F-11</b>	<b>Laser Platinum</b>	Fiat		500X	2017-2016	
Qty per Vehicle: 4-10		Box Qty: 4		Hyundai	Equus	2011		
Acura	CL	1999-1997		Genesis	2012-2009			
	CL	2003-2001		Santa Fe	2012-2007			
	EL	2000-1997		Sonata	2010-2009			
	Integra	2001-1992		Tucson	2013-2010			
	MDX	2002-2001		FX35	2008-2003			
	TL	2003-1999		FX45	2008-2003			
Chrysler	200	2014-2011		Infiniti	G35	2007-2003		
	Sebring	2007			I35	2004-2002		
	Sebring	2010-2009			M35	2008-2006		
Dodge	Avenger	2014-2008			M45	2004-2003		
	Caliber	2012-2007			M45	2010-2006		
	Dakota	2007-2003			Q45	2006-2002		
	Journey	2017-2009			QX4	2003-2001		
	Ram 2500	1996-1994			QX56	2010-2004		
	Ram 3500	1996-1994			Jeep	Cherokee	2017-2014	
Honda	Accord	2002-1990			Commander	2010-2008		
	Civic	2000-1992		Grand Cherokee	2017-2008			
	Civic del Sol	1997-1993		Renegade	2017-2015			
	CR-V	1998-1997		Kia	Borrego	2011-2009		
	Odyssey	2004-1995		Forte	2013-2010			
	Pilot	2005-2003		Forte5	2013-2012			
Hyundai	Prelude	1996-1990		Forte Koup	2013-2010			
	Elantra	2012-2007		Magentis	2010-2007			
Isuzu	Oasis	1999-1996		Optima	2010-2006			
Jeep	Compass	2017-2007		Rondo	2012-2007			
	Patriot	2017-2007		Sorento	2013-2011			
Kia	Soul	2011-2010		Sportage	2013-2011			
	Spectra	2009-2008		Mitsubishi	Mirage	2015-2014		
	Spectra5	2009-2008		Nissan	350Z	2006-2003		
Mazda	626	1997-1993		Altima	2006-2002			
	929	1991-1990		Armada	2015-2005			
	B2600	1993-1990		Frontier	2017-2005			
	Millenia	2002-1995		Maxima	2008-2002			
	MPV	1995-1990		Murano	2007-2003			
	MX-6	1997-1993		NV1500	2017-2012			
	Protege	2003-1999		NV2500	2017-2012			
Mitsubishi	Raider	2007-2006		NV3500	2017-2012			
<b>4435</b>		<b>ZFR5E-11</b>	<b>V-Power</b>	Pathfinder	2012-2001			
Qty per Vehicle: 4-6		Box Qty: 4		Pathfinder Armada	2004			
Nissan	240SX	1990-1989		Quest	2009-2004			
	300ZX	1996-1990		Sentra	2006-2000			
	Axxess	1995-1990		Titan	2015-2004			
	D21	1994-1990		Xterra	2015-2005			
	Pickup	1997-1995		X-Trail	2006-2005			
	Stanza	1992-1990		Ram	1500	2017-2011		
	<b>4458</b>		<b>ILFR6J-11K</b>	<b>Laser Iridium</b>	2500	2017-2011		
Qty per Vehicle: 8		Box Qty: 4		3500	2017-2011			
Honda	Civic	2011-2006		4500	2014			
<b>4469</b>		<b>LFR5AIX-11</b>	<b>Iridium IX</b>	5500	2014			
Qty per Vehicle: 3-16		Box Qty: 4		Dakota	2011			
Chrysler	200	2017-2015		ProMaster City	2017-2015			
	300	2017-2009		Scion	tC	2016-2011		
				Suzuki	Equator	2012-2009		



4469 (Cont'd)		LFR5AIX-11	Iridium IX
Qty per Vehicle: 3-16			Box Qty: 4
Suzuki	SX4		2013-2010
	SX4 Crossover		2012
Toyota	4Runner		2017-2013
	Camry		2017-2010
	FJ Cruiser		2014-2013
	Highlander		2017-2009
	RAV4		2017-2009
	Sienna		2013-2011
	Tundra		2014-2013
	Venza		2016-2009
4471		LKR8AP	Laser Platinum
Qty per Vehicle: 8-10			Box Qty: 4
BMW	M3		2013-2008
	M5		2010-2006
	M6		2010-2006
4477		ITR6F13	Laser Iridium
Qty per Vehicle: 4-12			Box Qty: 4
Aston Martin	DB7		2000
	Vanquish		2006-2002
Ford	Crown Victoria		2005-1996
	Escape		2005
	F-150		2003-1999
	Focus		2010-2003
	GT		2006-2005
	Mustang		2004-2003
	Mustang		2012-2007
	Ranger		2000-1997
	Taurus		2006-1999
Jaguar	X-Type		2005-2002
Mazda	3		2005-2004
	B4000		2000-1997
Mercury	Sable		2001
	Sable		2005-2003
4497		BCPR6EP-N-11	Laser Platinum
Qty per Vehicle: 4-6			Box Qty: 4
Acura	Integra		1989-1986
	Legend		1990-1986
Nissan	200SX		1988-1984
	300ZX		1989-1984
	Maxima		1988-1985
	Multi		1988-1986
	Stanza		1989-1984
Peugeot	405		1991-1989
Saab	9-5		2002-1999
	9000		1994-1991
Sterling	825		1988-1987
	827		1991-1989
4536		XR45	V-Power
Qty per Vehicle: 6-8			Box Qty: 4
Buick	Apollo		1975
	Century		1977-1975
	Electra		1984-1976
	Estate Wagon		1983-1976
	LeSabre		1984-1976
	Regal		1977-1975
	Riviera		1984-1976
	Skyhawk		1976-1975
	Skylark		1977-1975
Cadillac	Eldorado		1980-1979
	Seville		1980-1976
Oldsmobile	98		1984-1973
	Custom Cruiser		1984-1973
	Cutlass		1981-1975
	Cutlass Calais		1984-1978

4536 (Cont'd)		XR45	V-Power
Qty per Vehicle: 6-8			Box Qty: 4
Oldsmobile	Cutlass Cruiser		1983-1980
	Cutlass Salon		1980-1975
	Cutlass Salon		1985
	Cutlass Supreme		1984-1975
	Cutlass Tiara		1976
	Delta 88		1984-1973
	Omega		1977-1975
	Starfire		1976-1975
	Toronado		1984-1973
		Vista Cruiser	
Pontiac	Bonneville		1981-1977
	Catalina		1981-1977
	Firebird		1979-1977
	Grand LeMans		1977-1976
	Grand Prix		1977
	Grand Safari		1978-1977
	Laurentian		1981
	LeMans		1977-1976
	Parisienne		1981
	Phoenix		1977
	Sunbird		1976
	Ventura		1977-1975
4563		BCP6ET	Standard
Qty per Vehicle: 4			Box Qty: 4
Peugeot	405		1991
4588		PFR5A-11	Laser Platinum
Qty per Vehicle: 4			Box Qty: 4
Ford	Escort		1981
	EXP		1982
Kia	Rondo		2008-2007
Mercedes-Benz	SLK230		2000-1998
Mercury	LN7		1982
	Lynx		1981
4589		IFR6T11	Laser Iridium
Qty per Vehicle: 4-8			Box Qty: 4
Daewoo	Lanos		2002-1999
Lexus	ES300		1995-1994
	ES300		2003-1999
	ES330		2006-2004
	GS300		1993
	GS300		2005-2001
	GS400		2000-1998
	GS430		2007-2001
	GX470		2009-2003
	HS250h		2012-2010
	IS300		2005-2001
	LS400		2000-1990
	LS430		2006-2001
	LX470		2007-1998
RX300		2003-1999	
	RX330		2006-2004
	RX400h		2008-2006
	SC300		1994-1993
	SC400		2000-1992
	SC430		2010-2002
Lotus	Elan		1991
Mazda	Miata		1993-1990
Pontiac	Vibe		2006-2003
	Vibe		2010-2009
Scion	tC		2010-2005
	xB		2012-2008
Toyota	4Runner		2009-2003
	Avalon		1995
	Avalon		2004-2000



4589 (Cont'd)		IFR6T11	Laser Iridium	4696		IFR5D10	Laser Iridium
Qty per Vehicle: 4-8		Box Qty: 4		Qty per Vehicle: 8-24		Box Qty: 4	
Toyota	Camry		1996-1992	Mercedes-Benz	C43 AMG		2000-1998
	Camry		2011-2002		C240		2002-2001
	Celica		2005-1991		C280		2000-1999
	Corolla		2006-2005		C320		2002-2001
	Corolla		2012-2009		CL55 AMG		2002-2001
	Highlander		2010-2001		CL500		2002-1998
	Land Cruiser		2007-1998		CL600		1999-1998
	Matrix		2006-2003		CL600		2001
	Matrix		2012-2009		CLK55 AMG		2002-2001
	MR2		1995-1992		CLK320		2002-1998
	Previa		1997-1995		CLK430		2002-1999
	RAV4		1996		E55 AMG		2002-1999
	RAV4		2008-2001		E320		2002-1998
	Sequoia		2009-2005		E430		2002-1998
	Sienna		2006-2001		G500		2002
	Solara		2008-2002		ML55 AMG		2002-2000
Supra		1998-1993	ML320		2002-1998		
Tundra		2009-2005	ML430		2001-1999		
			ML500		2002		
			S55 AMG		2002-2001		
			S420		1999-1998		
			S430		2002-2000		
			S500		1999-1998		
			S600		1999-1998		
			S600		2001		
			SL500		1998		
			SL500		2002-2001		
			SL600		2002-1998		
			SLK320		2002-2001		
<b>4639</b>		<b>PFR6L-11</b>	<b>Laser Platinum</b>	<b>4764</b>		<b>BUR7EQP</b>	<b>Laser Platinum</b>
Qty per Vehicle: 6		Box Qty: 4		Qty per Vehicle: 2		Box Qty: 10	
Acura	NSX		2005-1997	Mazda	RX-7		1991-1986
<b>4642</b>		<b>PFR5J-11</b>	<b>Laser Platinum</b>		RX-7		1995-1993
Qty per Vehicle: 4-6		Box Qty: 4		<b>4772</b>		<b>DR9EIX</b>	<b>Iridium IX</b>
Chevrolet	Tracker		2003-2001	Qty per Vehicle: 12		Box Qty: 4	
Mitsubishi	Diamante		2004-1997	Lamborghini	Diablo		1996-1992
	Eclipse		2005-1996	<b>4793</b>		<b>PFR6G</b>	<b>Laser Platinum</b>
	Expo		1995-1993	Qty per Vehicle: 4-8		Box Qty: 4	
	Expo LRV		1994-1992	Audi	90 Quattro		1992-1990
	Galant		2003-1992		A8 Quattro		2003
	Lancer		2007-2002		Coupe Quattro		1991-1990
	Mirage		2002-1993		S8		2003
	Montero		2002-1994	Chrysler	Cirrus		2000
	Montero Sport		2004-1997		Neon		2002-2000
	Outlander		2003	Dodge	Neon		2005-1995
Suzuki	Aerio		2002		Stratus		2000-1995
	Grand Vitara		2002-2000		SX 2.0		2005-2003
	Vitara		2002-2000	Geo	Tracker		1997-1994
	XL-7		2002	Hyundai	Scoupe		1995-1993
<b>4644</b>		<b>BKR7E</b>	<b>V-Power</b>	Isuzu	Impulse		1992-1991
Qty per Vehicle: 5-8		Box Qty: 4		Jaguar	Vanden Plas		1996-1988
Aston Martin	DB7		1998-1997		XJ6		1997-1987
Audi	200 Quattro		1991		XJR		1996-1995
	S4		1994-1992		XJS		1996-1992
	S6		1997-1995	Kia	Rio		2002-2001
BMW	Alpina B7		2008-2007		Sephia		2001-1998
Porsche	911		2005-2004	Lotus	Elan		1990
<b>4652</b>		<b>WR4-1</b>	<b>V-Power</b>		Elan		1992
Qty per Vehicle: 6		Box Qty: 4		Nissan	D21		1994-1990
Ford	Bronco		1992-1987		Pathfinder		1995-1990
	E-150 Econoline		1996-1987		Pickup		1995
	E-150 Econoline Club Wagon		1996-1987	Plymouth	Breeze		2000-1996
	E-250 Econoline		1996-1987		Neon		2001-1995
	E-250 Econoline Club Wagon		1991-1987				
	E-350 Econoline		1996-1987				
	E-350 Econoline Club Wagon		1996-1987				
	F-150		1996-1987				
	F-250		1996-1987				
F-350		1996-1987					
Mercury	Comet		1972-1971				
<b>4690</b>		<b>BUR6EA-11</b>	<b>Standard</b>				
Qty per Vehicle: 3		Box Qty: 4					
Subaru	Justy		1994-1991				





4793 (Cont'd)	PFR6G	Laser Platinum
Qty per Vehicle: 4-8		Box Qty: 4
Pontiac	Sunrunner	1997-1995
Saab	9-2X	2005
Subaru	Impreza	2005-2002
Suzuki	Esteem	2000-1995
	Sidekick	1998-1993
	Swift	1993-1992
	X-90	1998-1996
Volkswagen	Golf	1986
	Golf	1993-1990
	Jetta	1992-1990
	Passat	1991-1990
Volvo	850	1994-1993
	960	1994-1992

4853	PFR7B	Laser Platinum
Qty per Vehicle: 5-8		Box Qty: 4
Audi	200 Quattro	1991
	S4	1994-1992
	S6	1997-1995
BMW	Alpina B7	2008-2007

4855	DR8EB	Standard
Qty per Vehicle: 12		Box Qty: 10
Ferrari	Testarossa	1991-1985

4867	IFR6B-K	Laser Iridium
Qty per Vehicle: 6-8		Box Qty: 4
Mitsubishi	Eclipse	2012-2006
	Galant	2009-2007
Toyota	Sequoia	2004-2001
	Tundra	2004-2000

4904	ILFR6T11	Laser Iridium
Qty per Vehicle: 4-8		Box Qty: 4
Lexus	GX460	2017-2010
	LX570	2011-2008
	LX570	2017-2013
Toyota	4Runner	2013-2003
	FJ Cruiser	2013-2007
	Land Cruiser	2011-2008
	Land Cruiser	2017-2013
	Sequoia	2016-2008
	Tacoma	2015-2005
	Tundra	2017-2005

4912	ILKAR7B11	Laser Iridium
Qty per Vehicle: 4		Box Qty: 4
Lexus	CT200h	2015-2011
Pontiac	Vibe	2010-2009
Scion	iQ	2014-2012
	xD	2014-2008
Toyota	Corolla	2015-2009
	Matrix	2014-2009
	Prius	2015-2010
	Prius Plug-In	2015-2012
	Prius V	2015-2012

4919	BCPR6EIX-11	Iridium IX
Qty per Vehicle: 4-6		Box Qty: 4
Acura	Integra	1989-1986
	Legend	1990-1986
Honda	Civic	1991-1988
	CRX	1991-1988
	Prelude	1990-1988
Lexus	ES250	1991-1990
	ES300	1993-1992
Mazda	323	1989-1988
Nissan	200SX	1988-1984
	300ZX	1989-1984

4919 (Cont'd)	BCPR6EIX-11	Iridium IX
Qty per Vehicle: 4-6		Box Qty: 4
Nissan	Maxima	1988-1985
	Multi	1988-1986
	Pulsar NX	1989-1987
	Stanza	1989-1984
Peugeot	405	1991-1989
Saab	9-3	2003-1999
	9-5	2009-1999
	9000	1994-1991
Sterling	825	1988-1987
	827	1991-1989
Toyota	Camry	1993-1988
	MR2	1989-1988

4922	BR6ES	Standard	
Qty per Vehicle: 4-8		Box Qty: 4	
Chevrolet	C10 Pickup	1969-1963	
	C10 Suburban	1969-1968	
	C20 Pickup	1961	
	C20 Pickup	1969-1963	
	C20 Suburban	1969-1968	
	C30 Pickup	1961	
	C30 Pickup	1969-1963	
	Corvette	1965	
	K10 Pickup	1966-1964	
	K20 Pickup	1961	
	K20 Pickup	1967-1964	
	K20 Suburban	1969-1968	
	K30 Pickup	1969-1968	
	P10 Series	1967	
	P20 Series	1961	
	P20 Series	1967-1964	
	P20 Van	1969-1968	
	P30 Series	1962-1961	
	P30 Series	1967-1964	
	P30 Van	1969-1968	
	Suburban	1961	
	Suburban	1966-1963	
	GMC	C15/C1500 Pickup	1969-1967
		C15/C1500 Suburban	1969-1967
		C25/C2500 Pickup	1969-1967
		C25/C2500 Suburban	1969-1967
		C35/C3500 Pickup	1969-1967
K15/K1500 Pickup		1967	
K15/K1500 Suburban		1968-1967	
K25/K2500 Pickup		1967	
K25/K2500 Suburban		1969-1967	
K35/K3500 Pickup		1969-1968	
P15/P1500 Van		1967	
P25/P2500 Van		1969-1967	
P35/P3500 Van		1969-1967	
PB15 Series		1966	
PB25 Series		1966	
Suburban	1966		
Honda	Accord	1978-1976	
	Civic	1979-1975	
MG	MGA	1958-1956	
	MGA	1962-1960	
	ZB	1958-1957	
Morris	Minor	1971-1970	
Nissan	280Z	1976-1975	
	411	1967	
	510	1973-1968	
	521 Pickup	1972-1969	
	610	1973	
	620 Pickup	1974-1972	
	1600	1970-1966	



4922 (Cont'd)		BR6ES	Standard	4996 (Cont'd)		IFR5T11	Laser Iridium	
Qty per Vehicle: 4-8			Box Qty: 4	Qty per Vehicle: 4-6			Box Qty: 4	
Porsche	914		1976-1970	Toyota	MR2		1991	
Renault	R12		1974-1971		MR2 Spyder		2005-2000	
	R15		1974-1972		Paseo		1995-1992	
	R16		1972-1969		Previa		1995-1991	
	R17		1972		Prius		2009-2001	
	R17		1974		Supra		1997-1993	
Volkswagen	Transporter		1973		Tacoma		2004-2000	
	Transporter		1991-1985		Yaris		2017-2006	
	Vanagon		1991-1983					
4936		ZFR5D-11	Standard		4997		PLZTR4A-13	Laser Platinum
Qty per Vehicle: 4			Box Qty: 4	Qty per Vehicle: 4-16			Box Qty: 4	
Nissan	240SX		1989	Chrysler	300		2008-2005	
					Aspen		2008-2007	
					PT Cruiser		2010-2001	
					Sebring		2006-2001	
					Voyager		2003-2001	
					Dodge	Caravan		2007-2001
				Charger			2008-2006	
				Durango			2008-2004	
				Magnum			2008-2005	
				Ram 1500			2008-2003	
				Ram 2500			2008-2003	
				Ram 3500			2008-2003	
				Stratus			2005-2004	
				Jeep		Commander		2008-2006
						Grand Cherokee		2008-2005
					Liberty		2005-2002	
					TJ		2003	
					TJ		2006-2005	
					Wrangler		2006-2003	
4952		BKR7ES-11	Standard	4998		PLZTR5A-13	Laser Platinum	
Qty per Vehicle: 4-6			Box Qty: 4	Qty per Vehicle: 4-16			Box Qty: 4	
Acura	Integra		2001	Chrysler	300		2010-2005	
Saab	9-5		2003-1999		Concorde		2004-1998	
					Intrepid		2004-1998	
					Pacifica		2008-2005	
					PT Cruiser		2009-2003	
					Sebring		2010-2001	
4959		BKR6EKC	Standard					
Qty per Vehicle: 8			Box Qty: 4	Dodge	Town & Country		2010-2001	
Lotus	Esprit		2003-1997		Voyager		2003-2001	
					Avenger		2010-2008	
					Caravan		2007-2001	
					Challenger		2010-2008	
					Charger		2010-2006	
					Grand Caravan		2010-2001	
					Intrepid		2004-1998	
					Magnum		2008-2005	
					Neon		2005-2003	
4968		TR6AP-13E	Laser Platinum					
Qty per Vehicle: 6			Box Qty: 4	Jeep	Stratus		2006-2001	
Jaguar	S-Type		2008-2000		Viper		2010-2008	
	X-Type		2008-2002		Viper		2017-2015	
4983		DCPR7E-N-10	Standard					
Qty per Vehicle: 4			Box Qty: 10		Grand Cherokee		2010-2006	
Fiat	500		2013-2012		Wrangler		2011-2007	
4984		PGR6A	Laser Platinum					
Qty per Vehicle: 4-8			Box Qty: 4		SRT		Viper	2014-2013
Audi	5000		1987		Volkswagen		Routan	2010-2009
	5000 Quattro		1986					
Land Rover	Discovery		1999	5017		LZTR4AGP	G-Power	
Maserati	Bora		1983-1975	Qty per Vehicle: 4-16			Box Qty: 4	
	Khamsin		1979-1975	Chrysler	300		2008-2005	
	Merak		1982-1975		Aspen		2008-2007	
	Quattroporte		1986-1979		PT Cruiser		2010-2001	
Nissan	200SX		1983-1980		Sebring		2006-2001	
	510		1981-1980		Voyager		2003-2001	
	720		1986-1981		Dodge	Caravan		2007-2001
	D21		1989-1986	Charger			2010-2006	
	Pathfinder		1988-1987	Grand Cherokee			2010-2001	
Van		1988-1987	Intrepid			2004-1998		
4996		IFR5T11	Laser Iridium					
Qty per Vehicle: 4-6			Box Qty: 4					
Chevrolet	Prizm		2002-2000					
Geo	Prizm		1989					
	Storm		1993-1992					
Lexus	GS300		1997-1994					
	SC300		1992					
	SC300		1998-1994					
Pontiac	Vibe		2008-2003					
Saturn	SC		1992-1991					
	SC2		2002-1993					
	SL2		2002-1991					
	SW2		2001-1993					
Scion	xB		2015-2012					
Toyota	4Runner		2000					
	Celica		1990					
	Celica		2005-2000					
	Corolla		2008-2000					
	Corolla		2012					
	Echo		2000					
	Matrix		2008-2003					
	Matrix		2013-2012					



5017 (Cont'd)		LZTR4AGP	G-Power	5018 (Cont'd)		LFR5AGP	G-Power	
Qty per Vehicle: 4-16			Box Qty: 4	Qty per Vehicle: 3-16			Box Qty: 4	
Dodge	Magnum		2008-2005	Nissan	Pathfinder Armada		2004	
	Ram 1500		2008-2003		Quest		2009-2004	
	Ram 2500		2008-2003		Sentra		2006-2000	
	Ram 3500		2008-2003		Titan		2015-2004	
	Stratus		2005-2004		Xterra		2015-2005	
Jeep	Commander		2008-2006	X-Trail		2006-2005		
	Grand Cherokee		2008-2005		1500		2017-2011	
	Liberty		2005-2002		2500		2017-2011	
	TJ		2003		3500		2017-2011	
	TJ		2006-2005		4500		2014	
	Wrangler		2006-2003	5500		2014		
				Dakota		2011		
				ProMaster City		2017-2015		
				Scion	tC		2016-2011	
				Suzuki	Equator		2012-2009	
					SX4		2013-2010	
					SX4 Crossover		2012	
				Toyota	4Runner		2017-2013	
					Camry		2017-2010	
					FJ Cruiser		2014-2013	
					Highlander		2017-2009	
					RAV4		2017-2009	
					Sienna		2013-2011	
					Tundra		2014-2013	
					Venza		2016-2009	
5018		LFR5AGP	G-Power	5019		LTR5GP	G-Power	
Qty per Vehicle: 3-16			Box Qty: 4	Qty per Vehicle: 4-8			Box Qty: 4	
Chrysler	200		2017-2015	Buick	Allure		2010	
	300		2017-2009		Envision		2017	
	Aspen		2009-2008		LaCrosse		2016-2010	
Dodge	Challenger		2017-2009		Rainier		2007-2004	
	Charger		2017-2009		Regal		2017-2011	
	Dakota		2010-2008	Verano		2017-2012		
	Dart		2016-2013	Cadillac	ATS		2017-2013	
	Durango		2009-2008		Escalade		2017-2015	
	Durango		2017-2011		Escalade ESV		2017-2015	
	Ram 1500		2010-2008		Chevrolet	Camaro		2017-2016
	Ram 2500		2010-2009			Captiva Sport		2015-2012
Ram 3500		2009	Cavalier			2005-2002		
Fiat	500X		2017-2016	Classic			2005-2004	
Hyundai	Equus		2011	Cobalt			2010-2005	
	Genesis		2012-2009	Colorado			2012-2004	
	Santa Fe		2012-2007	Colorado			2016-2015	
	Sonata		2010-2009	Corvette			2017-2014	
	Tucson		2013-2010	Equinox			2017-2010	
Infiniti	FX35		2008-2003	HHR			2011-2006	
	FX45		2008-2003	Impala		2017-2014		
	G35		2007-2003	Malibu		2015-2004		
	I35		2004-2002	Malibu Limited		2016		
	M35		2008-2006	Orlando		2014-2012		
	M45		2004-2003	Silverado 1500		2017-2014		
	M45		2010-2006	Suburban		2017-2015		
	Q45		2006-2002	Tahoe		2017-2015		
	QX4		2003-2001	Trailblazer		2009-2002		
QX56		2010-2004	Trailblazer EXT		2006-2002			
Jeep	Cherokee		2017-2014	Ford	C-Max		2017-2013	
	Commander		2010-2008		Contour		2000-1995	
	Grand Cherokee		2017-2008		Edge		2011-2007	
	Renegade		2017-2015		Escape		2004-2001	
Kia	Borrego		2011-2009		Escape		2017-2009	
	Forte		2013-2010		Escort		2003-1998	
	Forte5		2013-2012		Flex		2012-2009	
	Forte Koup		2013-2010		Focus		2004-2000	
	Magentis		2010-2007		Fusion		2018-2006	
	Optima		2010-2006		Taurus		2012-2008	
	Rondo		2012-2007					
	Sorento		2013-2011					
	Sportage		2013-2011					
	Mitsubishi	Mirage		2015-2014				
Nissan	350Z		2006-2003					
	Altima		2006-2002					
	Armada		2015-2005					
	Frontier		2017-2005					
	Maxima		2008-2002					
	Murano		2007-2003					
	NV1500		2017-2012					
	NV2500		2017-2012					
	NV3500		2017-2012					
	Pathfinder		2012-2001					



5019 (Cont'd)		LTR5GP	G-Power	5044 (Cont'd)		BR8EIX	Iridium IX
Qty per Vehicle: 4-8			Box Qty: 4	Qty per Vehicle: 4-12			Box Qty: 4
Ford	Taurus X		2009-2008	Porsche	911		1968
	Transit Connect		2017-2014		911		1971-1970
GMC	Acadia		2017	Renault	Fuego		1984-1982
	Canyon		2012-2004		R17		1974-1973
	Canyon		2016-2015	<b>5077 ZGR5A V-Power</b>			
	Envoy		2009-2002	Qty per Vehicle: 6			Box Qty: 4
	Envoy XL		2006-2002	BMW	325		1988-1986
	Envoy XUV		2005-2004		325e		1987-1984
	Sierra 1500		2017-2014		325es		1987-1986
	Terrain		2017-2010		325i		1993-1987
	Yukon		2017-2015		325is		1991-1987
Yukon XL		2017-2015	325iX			1991-1988	
Hummer	H3		2010-2006		525i		1990-1989
	H3T		2010-2009		528e		1988-1982
Isuzu	Ascender		2008-2003		535i		1993-1989
	i-280		2006		635CSi		1989-1988
	i-290		2008-2007	735i		1992-1988	
	i-350		2006	735iL		1992-1988	
	i-370		2008-2007	L7		1987-1986	
Lincoln	MKS		2013-2009	<b>5084 ZFR5A-11 V-Power</b>			
	MKT		2012-2010	Qty per Vehicle: 4-6			Box Qty: 4
	MKX		2010-2007	Jeep	Cherokee		1985-1981
	MKZ		2017-2007		CJ5		1983-1981
Mazda	3		2013-2006		CJ7		1986-1981
	3 Sport		2010-2009		Grand Wagoneer		1986-1984
	3 Sport		2013-2012		J10		1987-1981
	5		2010-2008		Scrambler		1985-1981
	5		2015-2012	Wagoneer		1985-1980	
	6		2013-2006	Wrangler		1990-1987	
	CX-7		2012-2010	<b>5110 B7HS Standard</b>			
	Tribute		2004-2001	Qty per Vehicle: 2			Box Qty: 4
Tribute		2011-2009	Subaru	360		1970-1968	
Mercury	Cougar		2002-1999	<b>5118 PLZKAR6A-11 Laser Platinum</b>			
	Mariner		2011-2009	Qty per Vehicle: 4			Box Qty: 4
	Milan		2011-2006	Nissan	Frontier		2017-2005
	Mystique		2000-1995		Micra		2017-2015
	Sable		2009-2008		Sentra		2010-2007
Oldsmobile	Alero		2004-2002		Sentra		2017-2013
	Bravada		2004-2002		Versa		2017-2012
Pontiac	G5		2010-2007	Versa Note		2017-2014	
	G6		2010-2006	<b>5122 BR7ES Standard</b>			
	Grand Am		2005-2002	Qty per Vehicle: 4-6			Box Qty: 4
	Pursuit		2006-2005	Honda	Accord		1979
	Solstice		2009-2006		Prelude		1980-1979
	Sunfire		2005-2002	MG	MGA		1959
	Saab	9-5		2011	Porsche	911	
9-7x			2009-2005	911			1973
Saturn	Aura		2010-2007	<b>5141 TR6GP G-Power</b>			
	Ion		2007-2003	Qty per Vehicle: 4-12			Box Qty: 4
	L100		2002-2001	Aston Martin	DB7		2000
	L200		2003-2001	Cadillac	CTS		2015-2009
	L300		2004	Chevrolet	Camaro		2015-2012
	LS		2000		Corvette		2013-2006
	LS1		2000	Ford	Crown Victoria		2005-1996
	LW1		2000		Escape		2005
	LW200		2003-2001		F-150		2003-1999
	Sky		2010-2007		Focus		2010-2003
	Vue		2010-2002		GT		2006-2005
<b>5044 BR8EIX Iridium IX</b>					Mustang		2004-2003
Qty per Vehicle: 4-12			Box Qty: 4	Mustang		2014-2007	
Ferrari	512 BB		1985-1982	Ranger		2000-1997	
Lamborghini	Countach		1985-1982	Taurus		2006-1999	
	Jalpa		1988-1982	Mazda	3		2005-2004
	Silhouette		1977-1976				
	Urraco		1976-1974				



5141 (Cont'd)		TR6GP	G-Power
Qty per Vehicle: 4-12			Box Qty: 4
Mazda	B4000		2000-1997
Mercury	Sable		2001
	Sable		2005-2003
Pontiac	Firebird		1989
	Grand Prix		1990-1989
Rover	2000		1971-1968
5155		FR4	V-Power
Qty per Vehicle: 4-8			Box Qty: 4
Buick	Skylark		1994-1988
Chevrolet	Beretta		1991-1990
	Camaro		1992-1987
	Corvette		1991-1986
Dodge	B150		1994-1992
	B250		1994-1992
	B350		1994-1992
	B1500		1996-1995
	B2500		1997-1995
	B3500		1997-1995
	D150		1993-1992
	D250		1993-1992
	D350		1993
	Dakota		1996-1992
	Ram 1500		1997-1994
	Ram 2500		1997-1994
	Ram 3500		1997
	Ramcharger		1993-1992
	W150		1993-1992
	W250		1993-1992
W350		1993	
Ford	F-100		1982
	Granada		1982
	Thunderbird		1982
Jeep	Grand Cherokee		1996-1993
	Grand Wagoneer		1993
Lincoln	Continental		1982
Mercury	Cougar		1982
Oldsmobile	Achieva		1994-1992
	Calais		1987
	Cutlass Calais		1991-1988
	Cutlass Supreme		1991-1990
Pontiac	Firebird		1987
	Grand Am		1994-1988
	Grand Prix		1991-1990
5245		ILFR7H	Laser Iridium
Qty per Vehicle: 4			Box Qty: 4
Mitsubishi	Lancer		2006
5255		BUR9EQP	Laser Platinum
Qty per Vehicle: 2-4			Box Qty: 10
Mazda	RX-7		1991-1984
	RX-7		1995-1993
5258		CR8EIB-9	Laser Iridium
Qty per Vehicle: 8			Box Qty: 4
Ferrari	F40		1992-1990
5266		IZFR6K-11S	Laser Iridium
Qty per Vehicle: 4			Box Qty: 4
Honda	Civic		2011-2006
5275		BCPR6EP-N-8	Laser Platinum
Qty per Vehicle: 6			Box Qty: 4
Toyota	Supra		1992-1987
5306		LZTR4A-11	V-Power
Qty per Vehicle: 4-16			Box Qty: 4
Chrysler	300		2008-2005
	Aspen		2008-2007

5306 (Cont'd)		LZTR4A-11	V-Power	
Qty per Vehicle: 4-16			Box Qty: 4	
Chrysler	PT Cruiser		2010-2001	
	Sebring		2006-2001	
	Voyager		2003-2001	
Dodge	Caravan		2007-2001	
	Charger		2008-2006	
	Durango		2008-2004	
	Magnum		2008-2005	
	Ram 1500		2008-2003	
	Ram 2500		2008-2003	
	Ram 3500		2008-2003	
	Stratus		2005-2004	
	Jeep	Commander		2008-2006
		Grand Cherokee		2008-2005
Liberty			2005-2002	
TJ			2003	
TJ			2006-2005	
Wrangler			2006-2003	
5344		IFR6D10	Laser Iridium	
Qty per Vehicle: 4-24			Box Qty: 4	
Audi	A4		2005-2002	
	A4 Quattro		2006-2002	
	A4 Quattro		2009	
	A5 Quattro		2010-2008	
	A6		2004-2002	
	A6		2011-2009	
	A6 Quattro		2004-2002	
	Q5		2012-2009	
	Chrysler	Crossfire		2006-2005
	Dodge	Dakota		2007-2005
Jeep	Grand Cherokee		2004-2002	
Mercedes-Benz	C32 AMG		2004-2002	
	C55 AMG		2006-2005	
	C230		2002	
	CL600		2002	
	CLK55 AMG		2006-2003	
	S600		2002	
	SLK32 AMG		2004-2002	
	SLK55 AMG		2011-2005	
Saab	9-3		2011-2004	
	9-3X		2011-2010	
5368		IFR6B11	Laser Iridium	
Qty per Vehicle: 8			Box Qty: 4	
Volvo	S80		2010-2007	
	XC90		2011-2005	
5370		BUR4EB-11	Standard	
Qty per Vehicle: 4			Box Qty: 4	
Honda	Civic		1987-1984	
5422		BR8ES	Standard	
Qty per Vehicle: 4-6			Box Qty: 4	
Porsche	911		1968	
	911		1971-1970	
Renault	Fuego		1984-1982	
	R17		1974-1973	
5424		BKR4E-11	V-Power	
Qty per Vehicle: 4-8			Box Qty: 4	
Rolls-Royce	Corniche IV		1995-1993	
	Corniche S		1995	
	Flying Spur		1995	
	Silver Spirit		1995-1992	
	Silver Spur		1998-1992	
	Touring Limousine		1994	
Saturn	SC1		2002-1993	





5424 (Cont'd)		BKR4E-11	V-Power	5464 (Cont'd)		BKR5EIX-11	Iridium IX	
Qty per Vehicle: 4-8			Box Qty: 4	Qty per Vehicle: 4-24			Box Qty: 4	
Saturn	SL		2002-1991	Jaguar	XF		2010-2009	
	SL1		2002-1991		XJ8		2009-1998	
	SW1		1999-1993		XJR		2009-2004	
<b>5459</b>			<b>PFR5L-11</b>		<b>Laser Platinum</b>	XK		2009-2007
Qty per Vehicle: 6			Box Qty: 4		XK8		2006-1997	
Acura	RL		2004-1996		XKR		2002-2000	
	TL		1998-1996		XKR		2009-2004	
<b>5463</b>			<b>FR5AP-11</b>	<b>Laser Platinum</b>	Kia	Amanti	2009-2004	
Qty per Vehicle: 4			Box Qty: 4	Magentis		2008-2001		
Saab	9-2X		2006-2005	Optima		2008-2001		
Subaru	Baja		2006-2004	Rio		2011-2006		
	Forester		2010-2005	Rio5		2011-2006		
	Impreza		2011-2005	Rondo		2008-2007		
	Legacy		2009-2004	Sedona		2012-2002		
	Outback		2009-2004	Sedona		2014		
<b>5464</b>			<b>BKR5EIX-11</b>	<b>Iridium IX</b>		Sephia	1997-1995	
Qty per Vehicle: 4-24			Box Qty: 4	Sorento		2009-2003		
Acura	RL		2004-1996	Spectra		2007-2004		
	SLX		1999-1996	Spectra5		2007-2005		
	TL		1998-1995	Sportage		2010-2005		
	Vigor		1994-1992	Land Rover		LR3	2009-2005	
Chevrolet	Corvette		1992-1990			Range Rover	2009-2006	
	Prizm		2002-1998			Range Rover Sport	2009-2006	
	Tracker		2004-2001	Lexus		GS300	2000-1994	
Chrysler	Cirrus		2000-1995		SC300	1992		
	Crossfire		2008-2004		SC300	2000-1994		
	Sebring		2005-1995	Lincoln	LS	2006-2000		
Dodge	Avenger		2000-1995		Mazda	2	2014-2011	
	Colt		1994-1993			323	1991-1990	
	Stratus		2000-1995			323	1994-1993	
Eagle	Summit		1996-1992			626	2002-1993	
	Ford	Taurus	1995-1989			929	1995-1992	
Geo		Prizm	1989			Miata	1997-1994	
	Honda	Storm	1993-1992			Miata	2005-1999	
Hyundai		Civic	2005-2003			MPV	1998-1996	
	Passport	2002-1997	MX-3			1996-1992		
	Accent	2011-1995	MX-6			1997-1993		
	Azera	2011-2006	Protege	2003-1990				
	Elantra	2007-1996	Protege5	2003-2002				
	Entourage	2010-2007	Mercedes-Benz	C43 AMG	2000-1998			
	Santa Fe	2009-2001		C240	2005-2001			
	Scoupe	1995-1993		C280	2000-1998			
	Sonata	2010-1999		C320	2005-2001			
	Tiburon	2001-1997		CL55 AMG	2002-2001			
	Tiburon	2008-2003		CL500	2006-1998			
	Tucson	2009-2005		CL600	1999-1998			
	Veracruz	2012-2007		CL600	2001			
	XG300	2001		CLK55 AMG	2002-2001			
	XG350	2005-2002		CLK320	2005-1998			
Infiniti	G20	2002-1999		CLK430	2003-1999			
	I30	2001-1996		CLK500	2006-2003			
	J30	1997-1993		CLS500	2006			
	Q45	2001-1990		E55 AMG	2002-1999			
	QX4	2000-1997		E320	2005-1998			
Isuzu	Amigo	2000-1998	E430	2002-1998				
	Axiom	2003-2002	E500	2006-2003				
	Rodeo	2004-1996	G55 AMG	2004-2003				
	Rodeo Sport	2003-2001	G500	2008-2002				
	Trooper	2002-1996	ML55 AMG	2003-2000				
	VehiCROSS	2001-1999	ML320	2003-1998				
Jaguar	S-Type	2008-2000	ML350	2005-2003				
	Super V8	2009-2005	ML430	2001-1999				
	Vanden Plas	2009-1997	ML500	2004-2002				
			ML500	2007				
			R500	2007-2006				



5464 (Cont'd)	BKR5EIX-11	Iridium IX
Qty per Vehicle: 4-24		Box Qty: 4
Mercedes-Benz	S55 AMG	2002-2001
	S420	1999-1998
	S430	2006-2000
	S500	2006-1998
	S600	1999-1998
	S600	2001
	SL500	2006-1998
	SL600	2002-1998
	SLK320	2004-2001
Mercury	Villager	2002-1999
Mitsubishi	Diamante	2004-1997
	Eclipse	2005-1996
	Expo	1995-1993
	Expo LRV	1994-1992
	Galant	2003-1992
	Lancer	2007-2002
	Lancer	2017-2011
	Mirage	2002-1993
	Montero	2002-1994
	Montero Sport	2004-1997
	Outlander	2003
	Outlander	2013-2011
	Outlander Sport	2017-2015
RVR	2017-2015	
Nissan	240SX	1998-1991
	300ZX	1996-1990
	Altima	2001-1993
	Frontier	2004-1998
	Maxima	2001-1992
	NX	1993-1991
	Pathfinder	2000-1996
	Quest	2002-1999
	Sentra	2001-1991
	Xterra	2004-2000
	Plymouth	Colt
Pontiac	Vibe	2008-2003
Saab	9-2X	2006-2005
Saturn	SC	1992-1991
	SC2	2002-1993
	SL2	2002-1991
	SW2	2001-1993
Scion	xB	2015-2012
Subaru	Baja	2006-2004
	Forester	1998
	Forester	2010-2005
	Impreza	1998
	Impreza	2011-2005
	Legacy	1999-1996
	Legacy	2009-2004
Outback	2009-2004	
Suzuki	Aerio	2007-2002
	Grand Vitara	2005-2000
	SX4	2009-2007
	Vitara	2004-2000
	XL-7	2003-2002
Toyota	4Runner	2002-1996
	Celica	1990
	Celica	2005-2000
	Corolla	2008-1998
	Corolla	2012
	Echo	2000
	Matrix	2008-2003
	Matrix	2013-2012
	MR2	1991
	MR2 Spyder	2005-2000

5464 (Cont'd)	BKR5EIX-11	Iridium IX
Qty per Vehicle: 4-24		Box Qty: 4
Toyota	Paseo	1999-1992
	Previa	1995-1991
	Prius	2009-2001
	Supra	1998-1993
	T100	1998-1995
	Tacoma	2004-1995
	Tercel	1999-1995
	Tundra	2004-2000
	Yaris	2017-2006
	Volkswagen	Beetle
<b>5468</b>		<b>SILFR6A11</b>
Qty per Vehicle: 4		Box Qty: 4
Suzuki	Grand Vitara	2012-2009
	Kizashi	2012-2010
<b>5476</b>		<b>ILTR5D</b>
Qty per Vehicle: 4		Box Qty: 4
Buick	Allure	2010
	LaCrosse	2016-2010
	Regal	2017-2011
	Verano	2017-2012
Chevrolet	Captiva Sport	2015-2012
	Cobalt	2010-2008
	Equinox	2017-2010
	HHR	2010-2008
	Impala	2014
	Malibu	2014-2013
	Orlando	2014-2012
GMC	Terrain	2017-2010
Pontiac	Solstice	2009-2008
Saab	9-5	2011
Saturn	Sky	2010-2007
<b>5496</b>		<b>BKUR7ET</b>
Qty per Vehicle: 4		Box Qty: 4
Volkswagen	Golf	1989-1987
	Jetta	1989-1987
	Passat	1994-1992
	Scirocco	1988-1986
<b>5507</b>		<b>PZNR6A11H</b>
Qty per Vehicle: 8-10		Box Qty: 4
Ford	Expedition	2014-2008
	Explorer	2010-2008
	Explorer Sport Trac	2010-2008
	F53	2009-2008
	F53	2017-2011
	F59	2017-2011
	F650	2013-2012
	F-150	2010-2008
	F-250 Super Duty	2010-2008
	F-350 Super Duty	2010-2008
	F-450 Super Duty	2017-2008
F-550 Super Duty	2017-2008	
	Mustang	2010-2008
Lincoln	Mark LT	2008
	Navigator	2014-2008
Mercury	Mountaineer	2010-2008
<b>5509</b>		<b>BCPR7ET</b>
Qty per Vehicle: 6		Box Qty: 4
Porsche	911	1989
	911	1998-1992
<b>5534</b>		<b>BPR7ES</b>
Qty per Vehicle: 4-12		Box Qty: 4
Alfa Romeo	164	1993-1991
	Berlina	1971-1969



5534 (Cont'd)		BPR7ES	Standard	5542 (Cont'd)		PFR6T-10G	Laser Platinum
Qty per Vehicle: 4-12			Box Qty: 4	Qty per Vehicle: 4-24			Box Qty: 4
Alfa Romeo	Duetto 1600		1968-1967	Mercedes-Benz	SLK230		2004-2001
	Giulia		1967-1964		Saab	9-3	
	Giulia Sprint		1968-1967			9-3X	
	GTC		1964	<b>5545</b>		<b>DPR9EIX-9</b>	<b>Iridium IX</b>
	GTV		1968-1967	Qty per Vehicle: 12			Box Qty: 4
	GT Veloce		1974-1969	Lamborghini	Countach		1989-1985
	Milano		1989-1987		Diablo		1991
	Spider		1994-1969		LM002		1990-1986
Audi	100 Series		1977-1972	<b>5547</b>		<b>PFR6W-TG</b>	<b>Laser Platinum</b>
	5000		1985-1984	Qty per Vehicle: 8-10			Box Qty: 4
	Quattro		1986-1983	Audi	A6 Quattro		2011-2007
Ferrari	308 GTB		1980-1975		A8 Quattro		2012-2007
	308 GTB		1984-1982		Q7		2010-2007
	308 GTBi		1982-1981		S5		2012-2008
	308 GTS		1980-1977		S6		2011-2007
	308 GTS		1984-1982		S8		2009-2007
	308 GTSi		1982-1981	Volkswagen	Touareg		2009-2007
	365 GT		1970-1968	<b>5553</b>		<b>BKR6ES-11</b>	<b>Standard</b>
	365 GT4		1976-1973	Qty per Vehicle: 4-24			Box Qty: 4
	365 GT4 BB		1974	Acura	Integra		2001-1992
	365 GTB/4		1974-1968		Legend		1995-1991
365 GTC		1970-1968	NSX			2005-1991	
365 GTC/4		1972-1971	Aston Martin	DB9		2005	
365 GTS		1970-1968	Audi	A6 Quattro		2006-2005	
365 GTS/4		1974-1970	Chevrolet	Aveo		2008-2004	
Dino 308 GT4		1979-1973		Aveo5		2008-2006	
GTO		1987-1984		Cobalt		2007-2005	
Fiat	850			1973-1967	Epica		2006-2004
	350GT			1966-1964	Metro		2001-1998
Lamborghini	400GT			1968-1966	Tracker		1991-1990
	Countach		1976-1974	Tracker		2002-1998	
	Countach		1982-1981	Chrysler	Crossfire		2006-2005
	Espada		1978-1968		Sebring		1999-1995
	Islero		1970-1968	Sebring		2005-2001	
	Jarama		1976-1970	Daewoo	Lanos		2002-1999
	Miura		1972-1966		Nubira		2002-1999
	Lotus	Elan		1975-1962	Daihatsu	Charade	
Esprit			1991-1989	Rocky			1992-1990
Europa			1975-1967	Dodge	Avenger		1999-1995
Seven			1975-1969		Colt		1994-1993
Maserati	228i		1990-1989		Stealth		1996-1991
	425		1987-1986		Stratus		2005-2001
	Biturbo		1987	Eagle	Talon		1998-1995
	Mistral		1970-1968	Ford	Escort		1996-1991
	Spyder		1987-1986		Probe		1997-1993
	Spyder		1991-1989	Geo	Storm		1991-1990
Mercedes-Benz	300SL		1959-1954	GMC	Tracker		1991-1989
Peugeot	304		1972-1971	Honda	Civic		2000-1999
Porsche	911		1977-1969		Civic del Sol		1997-1994
	911		1983-1980		Passport		1996-1994
	924		1982-1977		Infiniti	G20	
	944		1989	M30			1992-1990
<b>5542</b>		<b>PFR6T-10G</b>	<b>Laser Platinum</b>	Isuzu	I-Mark		1989
Qty per Vehicle: 4-24			Box Qty: 4		Impulse		1992-1990
Chrysler	Crossfire		2006-2005		Rodeo		1995-1993
Dodge	Dakota		2007-2005		Rodeo		2003
Jeep	Grand Cherokee		2004-2002		Rodeo Sport		2003
Mercedes-Benz	C32 AMG		2004-2002		Stylus		1992-1991
	C55 AMG		2006-2005	Trooper		1995-1992	
	C230		2002	Jaguar	Vanden Plas		2003
	CL600		2002		XJR		2003-1998
	CLK55 AMG		2006-2003		XKR		2003
	S600		2002	Kia	Rio		2005-2003
	SLK32 AMG		2004-2002		Sportage		2002-1995
	SLK55 AMG		2011-2005				



5553 (Cont'd)	BKR6ES-11	Standard	5553 (Cont'd)	BKR6ES-11	Standard
Qty per Vehicle: 4-24		Box Qty: 4	Qty per Vehicle: 4-24		Box Qty: 4
Land Rover	Discovery	2004-1999	Suzuki	Grand Vitara	2008-2006
	Freelander	2005-2002		Swift	2001-1995
Lexus	ES300	2003-1994		Swift+	2008-2004
	ES330	2006-2004		Verona	2006-2005
	GS300	1993		Vitara	2002-1999
	GS300	2005-2001		XL-7	2006-2004
	GS400	2000-1998		Toyota	4Runner
	GS430	2007-2001	Avalon		2004-1995
	GX470	2009-2003	Camry		2011-1992
	HS250h	2012-2010	Celica		2005-1991
	IS300	2005-2001	Corolla		2006-2005
	LS400	2000-1990	Corolla		2012-2009
	LS430	2006-2001	Highlander		2010-2001
	LX470	2007-1998	Land Cruiser		2007-1998
	RX300	2003-1999	Matrix		2006-2003
	RX330	2006-2004	Matrix		2012-2009
RX400h	2008-2006	MR2	1995-1992		
SC300	1994-1993	Previa	1997-1995		
SC400	2000-1992	RAV4	2008-1996		
SC430	2010-2002	Sequoia	2009-2005		
Lotus	Elan	1991	Sienna	2006-1998	
	Elise	2007-2005	Solara	2008-1999	
	Exige	2006	Supra	1998-1993	
Mazda	Miata	1993-1990	Tundra	2009-2005	
	Protege	1994-1990	Volvo	S80	2010-2007
Mercedes-Benz	C32 AMG	2004-2002		XC90	2011-2005
	C55 AMG	2006-2005	<b>5555 PFR6G-11 Laser Platinum</b>		
	C230	2002	Qty per Vehicle: 4-12		Box Qty: 4
	CL600	2002	Acura	Integra	2000-1997
	CLK55 AMG	2006-2003		Legend	1995-1991
	S600	2002		NSX	1994-1991
	SLK32 AMG	2004-2002	Aston Martin	DB9	2005
	SLK55 AMG	2011-2005	Audi	A6 Quattro	2006-2005
	SLK230	2004-2001	Chevrolet	Cobalt	2007-2005
	Mercury	Capri		1994-1991	Epica
Tracer		1996-1991		Metro	2001-1998
Mitsubishi	3000GT	1999-1991		Tracker	2002-1998
	Diamante	1995-1992	Chrysler	Sebring	2005-2001
	Eclipse	2000-1999	Daewoo	Lanos	2002-1999
	Galant	2000-1999	Nubira	2002	
	Montero	1996-1995	Daihatsu	Charade	1992-1989
Montero Sport	1998-1997	Rocky	1992-1990		
Nissan	200SX	1998-1995	Dodge	Stratus	2005-2001
	Frontier	2004-2001	Ford	Escort	1996-1991
	Maxima	1994-1989	Probe	1997-1993	
	NX	1993-1991	Geo	Storm	1991-1990
	Sentra	1994-1991	Honda	Passport	1996-1994
	Sentra	1999-1998	Isuzu	I-Mark	1989
	Xterra	2004-2002		Impulse	1992-1990
	Plymouth	Colt		1994-1993	Rodeo
Vibe		2006-2003		Stylus	1992-1991
Vibe		2010-2009		Trooper	1995-1992
Wave		2008-2005	Kia	Rio	2005-2003
Pontiac	Wave5	2007-2005	Sportage	2002-1995	
	Wave5	2007-2005	Lotus	Elan	1991
Saturn	Ion	2007-2004	Mazda	Miata	1993-1990
Scion	tC	2010-2005	Protege	1994-1990	
	xB	2012-2008	Mercury	Capri	1994-1991
Subaru	Baja	2003		Tracer	1996-1991
	Forester	2004-1999	Mitsubishi	Eclipse	2000
	Impreza	2004-1993		Galant	2000-1999
	Legacy	2003-1990	Nissan	Frontier	2004-2001
	Outback	2003-2000		Xterra	2004-2002
	SVX	1997-1992	Pontiac	Vibe	2006-2003
Suzuki	Esteem	2002-1999	Saturn	Ion	2007-2004
	Grand Vitara	1999			



5555 (Cont'd)		PFR6G-11	Laser Platinum	5598 (Cont'd)		PTR6D-13	Laser Platinum
Qty per Vehicle: 4-12			Box Qty: 4	Qty per Vehicle: 4-12			Box Qty: 4
Scion	xB		2012	Mercury	Sable		2005-2003
Subaru	Baja		2003	<b>5599</b>		<b>ITR4A15</b>	<b>Laser Iridium</b>
	Forester		2004-1999	Qty per Vehicle: 4-8			Box Qty: 4
	Impreza		2004-1995	Buick	Allure		2009-2005
	Legacy		2003-1995		Century		2005-1994
	Outback		2003-2000		Electra		1990-1988
Suzuki	Esteem		2001-1999		LaCrosse		2009-2005
	Grand Vitara		1999		LeSabre		2005-1988
	Swift		2001-1995		Lucerne		2008-2006
	Verona		2006-2005		Park Avenue		2005-1991
	Vitara		2002-1999		Reatta		1991-1988
Toyota	Celica		2003		Regal		2004-1990
	Corolla		2012		Rendezvous		2007-2002
	Matrix		2003		Riviera		1993-1988
	Matrix		2006-2005		Riviera		1999-1995
	Matrix		2012		Skylark		1998-1994
<b>5581</b>		<b>ILTR5C11</b>	<b>Laser Iridium</b>	Chevrolet	Terraza		2006-2005
Qty per Vehicle: 4			Box Qty: 4		Astro		2005-1996
Chevrolet	Cavalier		2005-2002		Beretta		1996-1994
	Classic		2005-2004		Blazer		2002-1998
	Cobalt		2005		Blazer		2005-2004
	Malibu		2006-2004		C1500		1998-1997
Oldsmobile	Alero		2004-2002		C1500 Suburban		1997
Pontiac	Grand Am		2005-2002		C2500		2000-1996
	Pursuit		2006-2005		C2500 Suburban		1999-1996
	Sunfire		2005-2002		C3500		2000-1996
	Saturn	Ion			2007-2003	Camaro	
L100			2002-2001		Corsica		1996-1994
L200			2003-2001		Equinox		2009-2005
L300			2004	Express 1500		2002-1997	
LS			2000	Express 1500		2009-2004	
LS1			2000	Express 1500		2014-2011	
LW1			2000	Express 2500		2002-1997	
LW200			2003-2001	Express 2500		2005-2004	
Vue			2007-2002	Express 3500		2000-1996	
<b>5584</b>		<b>ZFR5J-11</b>	<b>V-Power</b>	Impala		2005-2000	
Qty per Vehicle: 4			Box Qty: 4	K1500		1998-1997	
Honda	Civic		1995-1992	K1500 Suburban		1997	
	Civic del Sol		1995-1993	K2500		2000-1996	
<b>5592</b>		<b>PFR7W-TG</b>	<b>Laser Platinum</b>	K2500 Suburban		1999-1996	
Qty per Vehicle: 6-10			Box Qty: 4	K3500		2000-1996	
Audi	A4		2008-2006	Lumina		2001-1995	
	A4 Quattro		2009-2005	Lumina APV		1996-1992	
	A6		2008-2006	Malibu		2006-1997	
	A6 Quattro		2008-2005	Monte Carlo		2005-1995	
	R8		2010-2008	P30		1999-1996	
	RS4		2008-2007	S10		2002-1998	
<b>5598</b>		<b>PTR6D-13</b>	<b>Laser Platinum</b>	S10		2004	
Qty per Vehicle: 4-12			Box Qty: 4	Silverado 1500		2002-1999	
Aston Martin	DB7		2000	Silverado 1500		2013-2004	
	Vanquish		2006-2002	Silverado 1500 Classic		2007	
Ford	Crown Victoria		2005-1996	Tahoe		1997	
	Escape		2005	Uplander		2006-2005	
	F-150		2003-1999	Venture		2005-1997	
	Focus		2007-2003	Ford	F-150		2008
	GT		2006-2005	GMC	C1500		1998-1997
	Mustang		2004-2003	C1500 Suburban		1997	
	Mustang		2012-2007	C2500		2000-1996	
	Ranger		2000-1997	C2500 Suburban		1999-1996	
	Taurus		2006-1999	C3500		2000-1996	
Jaguar	X-Type		2005-2002	Jimmy		2002-1998	
Mazda	3		2005-2004	Jimmy		2005	
	B4000		2000-1997	K1500		1998-1997	
Mercury	Sable		2001	K1500 Suburban		1997	
				K2500		2000-1996	





5599 (Cont'd)		ITR4A15	Laser Iridium
Qty per Vehicle: 4-8			Box Qty: 4
GMC	K2500 Suburban		1999-1996
	K3500		2000-1996
	P3500		1999-1996
	Safari		2005-1996
	Savana 1500		2002-1997
	Savana 1500		2009-2004
	Savana 1500		2014-2011
	Savana 2500		2002-1997
	Savana 2500		2005-2004
	Savana 3500		2000-1996
	Sierra 1500		2002-1999
	Sierra 1500		2013-2004
	Sierra 1500 Classic		2007
	Sonoma		2002-1998
	Sonoma		2004
	Yukon		1997
	Oldsmobile	88	
98			1996-1988
Achieva			1998-1994
Alero			2004-1999
Cutlass			1999-1997
Cutlass Ciera			1996-1994
Cutlass Supreme			1997-1993
Delta 88			1991-1988
Intrigue			1999-1998
LSS			1999-1996
Regency			1998-1997
Silhouette			2004-1992
Toronado			1992-1988
Pontiac		Aztek	
	Bonneville		2005-1988
	Firebird		2002-1995
	G6		2006-2005
	Grand Am		2005-1994
	Grand Prix		2008-1994
	Montana		2006-1999
	Torrent		2009-2006
	Trans Sport		1999-1992
	Saturn	Relay	
5632		BCPR6E-11	V-Power
Qty per Vehicle: 4-6			Box Qty: 4
Acura	Integra		1989-1988
	Legend		1990-1986
Honda	Civic		1991-1988
	CRX		1991-1988
Lexus	ES250		1991-1990
	ES300		1993-1992
Mazda	323		1989-1988
Nissan	200SX		1988-1984
	300ZX		1989-1984
	Maxima		1988-1985
	Multi		1988-1986
	Pulsar NX		1989-1987
Peugeot	405		1991-1989
	9-5		2005-1999
Saab	9000		1994-1991
	825		1988-1987
Sterling	827		1991-1989
	Camry		1993-1988
Toyota	MR2		1989-1988
	5643		BKR5ESA-11
Qty per Vehicle: 4			Box Qty: 4
Saturn	SC		1992-1991

5643 (Cont'd)		BKR5ESA-11	Standard
Qty per Vehicle: 4			Box Qty: 4
Saturn	SC2		2002-1993
	SL2		2002-1991
	SW2		2001-1993
5648		IFR6Q-G	Laser Iridium
Qty per Vehicle: 4-24			Box Qty: 4
Audi	A4		1996
	A4		1999
	A4 Quattro		1996
	A4 Quattro		2000-1999
	A6 Quattro		1996-1995
	Cabriolet		1996-1995
Maybach	57		2012-2003
	62		2012-2003
Mercedes-Benz	CL65 AMG		2006-2005
	CL65 AMG		2014-2008
	CL600		2014-2003
	G65 AMG		2017-2016
	Maybach S600		2017-2016
	S65 AMG		2013-2006
	S65 AMG		2017-2015
	S600		2013-2003
	S600		2017-2015
	SL65 AMG		2011-2005
SL65 AMG		2017-2013	
SL600		2011-2004	
Volkswagen	Beetle		2001
	Beetle		2003
	Golf		2001
	Jetta		2001
	Passat		1998
	Passat		2000
5684		TR45-1GP	G-Power
Qty per Vehicle: 6			Box Qty: 4
Ford	Freestar		2007-2006
5685		BPR5EKU	Standard
Qty per Vehicle: 4-5			Box Qty: 4
Audi	80		1992-1991
	80 Quattro		1992-1988
	90 Quattro		1989-1988
	100		1991-1989
	100 Quattro		1991-1989
	5000		1988-1987
5000 Quattro			1988-1987
	Mitsubishi	Mirage	2002-2000
Volkswagen	Transporter		1993-1992
5686		DR7EIX	Iridium IX
Qty per Vehicle: 4-6			Box Qty: 4
BMW	M3		1991-1988
	M5		1988
	M6		1988-1987
5688		BCPR5EIX	Iridium IX
Qty per Vehicle: 4-6			Box Qty: 4
Geo	Prizm		1992-1990
Saab	900		1994-1991
Toyota	4Runner		1988
	Celica		1993-1988
	Corolla		1992-1988
5689		BCPR6EIX	Iridium IX
Qty per Vehicle: 4-8			Box Qty: 4
Aston Martin	Virage		1994-1990
Morgan	4/4		1994-1982
Saab	900		1998-1985
	9000		1990-1986



<b>5689 (Cont'd)</b>		<b>BCPR6EIX</b>	<b>Iridium IX</b>
Qty per Vehicle: 4-8			Box Qty: 4
Toyota	Supra		1992-1987
<b>5690</b>		<b>BCPR7EIX</b>	<b>Iridium IX</b>
Qty per Vehicle: 4-5			Box Qty: 4
Saab	900		1988-1985
	900		1994-1990
	9000		1990-1986
Volvo	850		1994
<b>5691</b>		<b>BCPR7EIX-11</b>	<b>Iridium IX</b>
Qty per Vehicle: 4			Box Qty: 4
Saab	9-3		1999
	900		1998-1994
	9000		1998-1989
<b>5693</b>		<b>BKR4EIX</b>	<b>Iridium IX</b>
Qty per Vehicle: 4-8			Box Qty: 4
Buick	Skylark		1994-1988
Chevrolet	Beretta		1991-1990
	Camaro		1992-1987
	Corvette		1991-1986
Dodge	B150		1994-1992
	B250		1994-1992
	B350		1994-1992
	B1500		1996-1995
	B2500		1997-1995
	B3500		1997-1995
	D150		1993-1992
	D250		1993-1992
	D350		1993
	Dakota		1996-1992
	Ram 1500		1997-1994
	Ram 2500		1997-1994
	Ram 3500		1997
	Ramcharger		1993-1992
	W150		1993-1992
W250		1993-1992	
W350		1993	
Ford	F-100		1982
	Granada		1982
	Thunderbird		1982
Jeep	Grand Cherokee		1996-1993
	Grand Wagoneer		1993
Lincoln	Continental		1982
Mercury	Cougar		1982
Oldsmobile	Achieva		1994-1992
	Calais		1987
	Cutlass Calais		1991-1988
	Cutlass Supreme		1991-1990
Pontiac	Firebird		1987
	Grand Am		1994-1988
	Grand Prix		1991-1990
Rolls-Royce	Corniche IV		1995-1993
	Corniche S		1995
	Flying Spur		1995
	Silver Spirit		1995-1992
	Silver Spur		1998-1992
	Touring Limousine		1994
Saturn	SC1		2002-1993
	SL		2002-1991
	SL1		2002-1991
	SW1		1999-1993
<b>5757</b>		<b>PFR6X-11</b>	<b>Laser Platinum</b>
Qty per Vehicle: 6			Box Qty: 4
Audi	A4 Quattro		2009
	A5 Quattro		2010-2008
	A6		2011-2009

<b>5757 (Cont'd)</b>		<b>PFR6X-11</b>	<b>Laser Platinum</b>
Qty per Vehicle: 6			Box Qty: 4
Audi	Q5		2012-2009
<b>5760</b>		<b>PGR5C-11</b>	<b>Laser Platinum</b>
Qty per Vehicle: 4			Box Qty: 4
Hyundai	Santa Fe		2006-2001
	Sonata		2005-1999
Kia	Magentis		2006-2001
	Optima		2006-2001
<b>5767</b>		<b>BKR6EQUA</b>	<b>Standard</b>
Qty per Vehicle: 5-8			Box Qty: 4
Audi	A6 Quattro		2004-2003
	Allroad Quattro		2005-2003
	S4		2009-2004
	S6		2003
Volkswagen	Phaeton		2006-2004
	Touareg		2007-2004
Volvo	850		1997-1995
	960		1997-1995
	S60		2005-2001
	S70		2000-1998
	S80		2004-1999
	S90		1998-1997
	V70		2007-1998
	V90		1998-1997
<b>5777</b>		<b>BUR9EQ</b>	<b>Standard</b>
Qty per Vehicle: 2-4			Box Qty: 4
Mazda	RX-7		1991-1984
	RX-7		1995-1993
<b>5787</b>		<b>ILZKR7B-11S</b>	<b>Laser Iridium</b>
Qty per Vehicle: 4-6			Box Qty: 4
Acura	ILX		2015-2013
	MDX		2013-2010
	RL		2012-2009
	TL		2014-2009
	TSX		2014-2009
	ZDX		2013-2010
Honda	Accord		2012-2008
	Civic		2015-2012
	Crosstour		2015-2012
	CR-V		2014-2010
<b>5791</b>		<b>BKR7E-11</b>	<b>V-Power</b>
Qty per Vehicle: 4-6			Box Qty: 4
Acura	Integra		2001
Saab	9-5		2003-1999
<b>5794</b>		<b>IFR7F-8DS</b>	<b>Laser Iridium</b>
Qty per Vehicle: 4			Box Qty: 4
Honda	Civic		2011-2006
<b>5809</b>		<b>TR6AP-13</b>	<b>Laser Platinum</b>
Qty per Vehicle: 4			Box Qty: 4
Ford	Focus		2010-2006
<b>5838</b>		<b>PFR5N-11</b>	<b>Laser Platinum</b>
Qty per Vehicle: 4-6			Box Qty: 4
Hyundai	Accent		2011-1995
	Elantra		2007-1996
	Santa Fe		2006-2001
	Scoupe		1995-1993
	Sonata		2005-1999
	Tiburon		2001-1997
	Tiburon		2008-2003
	Tucson		2009-2005
	XG300		2001
	XG350		2005-2002
Kia	Amanti		2006-2004
	Magentis		2006-2001



5838 (Cont'd)		PFR5N-11	Laser Platinum	5858 (Cont'd)		XR4	V-Power	
Qty per Vehicle: 4-6			Box Qty: 4	Qty per Vehicle: 6-8			Box Qty: 4	
Kia	Optima		2006-2001	Chrysler	Town & Country		1972-1967	
	Rio		2011-2006		Town & Country		1977-1975	
	Rio5		2011-2006		Windsor		1961-1957	
	Sedona		2005-2002	Dodge	330		1964-1963	
	Sephia		1997-1995		440		1964-1963	
	Sorento		2006-2003		880		1965-1962	
	Spectra		2007-2004		B200 Van		1971	
	Spectra5		2007-2005		B200 Van		1974	
Sportage		2010-2005	Challenger			1971-1970		
<b>5847</b>		<b>LKR7B-9</b>	<b>Standard</b>		<b>5851</b>		<b>PMR8A</b>	<b>Laser Platinum</b>
Qty per Vehicle: 3-6			Box Qty: 10		Qty per Vehicle: 8			Box Qty: 4
Mitsubishi	Outlander		2013-2007	Ferrari	360		2004-2000	
Smart	Fortwo		2015-2008	Maserati	Coupe		2004-2003	
<b>5851</b>		<b>PMR8A</b>	<b>Laser Platinum</b>	<b>5858</b>		<b>XR4</b>	<b>V-Power</b>	
Qty per Vehicle: 8			Box Qty: 4	Qty per Vehicle: 6-8			Box Qty: 4	
Ferrari	360		2004-2000	Buick	Century		1958-1954	
Maserati	Coupe		2004-2003		Electra		1965-1959	
Maserati	Spyder		2004-2002		Gran Sport		1965	
<b>5858</b>		<b>XR4</b>	<b>V-Power</b>		Gran Sport		1967	
Qty per Vehicle: 6-8			Box Qty: 4		Invicta		1963-1959	
Buick	Century		1958-1954		LeSabre		1965-1959	
	Electra		1965-1959		Limited		1958	
	Gran Sport		1965		Riviera		1965-1963	
	Gran Sport		1967		Roadmaster		1958-1953	
	Invicta		1963-1959		Skylark		1954	
	LeSabre		1965-1959		Skylark		1967-1965	
	Limited		1958		Special		1958-1951	
	Riviera		1965-1963		Special		1963-1962	
	Roadmaster		1958-1953	Special		1967-1965		
	Skylark		1954	Sportwagon		1967-1965		
	Skylark		1967-1965	Super		1958-1951		
	Special		1958-1951	Wildcat		1965-1963		
	Special		1963-1962	Cadillac	Calais		1967	
Special		1967-1965	DeVille			1967		
Sportwagon		1967-1965	Eldorado			1967		
Super		1958-1951	Fleetwood			1967		
Wildcat		1965-1963	Series 60 Fleetwood			1952-1950		
Cadillac	Calais		1967		Series 61		1951-1950	
	DeVille		1967		Series 62		1952	
	Eldorado		1967		Series 75 Fleetwood		1952-1950	
	Fleetwood		1967	Chevrolet	Bel Air		1969-1950	
	Series 60 Fleetwood		1952-1950		Biscayne		1969-1958	
	Series 61		1951-1950		Camaro		1969-1967	
	Series 62		1952		Caprice		1969-1966	
	Series 75 Fleetwood		1952-1950		Chevelle		1968-1964	
Chevrolet	Bel Air		1969-1950		Chevy II		1968-1963	
	Biscayne		1969-1958		El Camino		1968	
	Camaro		1969-1967		Impala		1968-1959	
	Caprice		1969-1966	Nova		1970		
	Chevelle		1968-1964	Chrysler	300		1969-1968	
	Chevy II		1968-1963		Cordoba		1978-1975	
	El Camino		1968		Imperial		1975-1959	
	Impala		1968-1959		Newport		1960-1959	
Nova		1970	Newport			1963-1962		
Chrysler	300		1969-1968		Newport		1978-1966	
	Cordoba		1978-1975		New Yorker		1972-1959	
	Imperial		1975-1959		New Yorker		1978-1975	
	Newport		1960-1959		Saratoga		1960-1957	
	Newport		1963-1962		Town & Country		1963-1957	
	Newport		1978-1966	Jeep	CJ3		1966	
	New Yorker		1972-1959		CJ5		1971-1966	
	New Yorker		1978-1975		CJ6		1971-1966	
	Saratoga		1960-1957		Commando		1967-1966	
	Town & Country		1963-1957		Dispatcher		1967-1966	
Jeep	CJ3		1966		DJ5		1970-1966	
	CJ5		1971-1966		DJ6		1968-1966	
	CJ6		1971-1966		FC150		1966	
	Commando		1967-1966		FC170		1966	
	Dispatcher		1967-1966		Jeepster		1971-1966	
	DJ5		1970-1966		Universal		1967-1966	
	DJ6		1968-1966		Oldsmobile	98		1974-1970
	FC150		1966			442		1971-1970
	FC170		1966	Custom Cruiser			1976-1971	
	Jeepster		1971-1966	Cutlass			1974-1968	
	Universal		1967-1966	Cutlass Supreme			1974-1971	
	Oldsmobile	98		1974-1970		Delmont 88		1968
		442		1971-1970		Delta 88		1974-1968
Custom Cruiser			1976-1971	F85			1972-1964	
Cutlass			1974-1968	Omega			1974-1973	
Cutlass Supreme			1974-1971	Toronado			1974-1968	
Delmont 88			1968	Vista Cruiser		1975-1968		
Delta 88			1974-1968	Plymouth	Barracuda		1964	
F85			1972-1964		Belvedere		1966-1955	
Omega			1974-1973		Custom		1961-1958	
Toronado			1974-1968		Fleet Special		1963-1960	
Vista Cruiser		1975-1968	Fury			1958-1956		
Plymouth	Barracuda		1964		Fury		1966-1960	
	Belvedere		1966-1955		Plaza		1958-1955	
	Custom		1961-1958		Satellite		1969-1965	
	Fleet Special		1963-1960		Savoy		1958-1955	
	Fury		1958-1956		Savoy		1964-1963	
	Fury		1966-1960	Suburban		1958-1955		
	Plaza		1958-1955	Pontiac	Bonneville		1971-1959	
	Satellite		1969-1965					
	Savoy		1958-1955					
	Savoy		1964-1963					
Suburban		1958-1955						
Pontiac	Bonneville		1971-1959					



<b>5858 (Cont'd)</b>		<b>XR4</b>	<b>V-Power</b>	<b>5987</b>		<b>PLZFR6A-11S</b>	<b>Laser Platinum</b>
Qty per Vehicle: 6-8			Box Qty: 4	Qty per Vehicle: 6			Box Qty: 4
Pontiac	Catalina		1971-1959	BMW	128i		2009-2008
	Executive		1970-1967		323i		2009-2008
	Firebird		1971-1967		328i		2009-2008
	Grand Prix		1971-1962		328i xDrive		2009
	Grand Safari		1971		328xi		2008
	Grandville		1971		528i		2010-2008
	GTO		1966-1964		528i xDrive		2010-2009
	GTO		1971-1970		528xi		2008
	LeMans		1971-1963		X3		2009-2008
	Star Chief		1966-1959		X5		2009-2008
	Tempest		1961		Z4		2009-2008
	Tempest		1968-1963				
	Tempest		1970				
	Ventura		1961-1960				
<b>5866</b>		<b>BR5ES</b>	<b>Standard</b>	<b>6043</b>		<b>ILZKAR7A10</b>	<b>Laser Iridium</b>
Qty per Vehicle: 4-8			Box Qty: 4	Qty per Vehicle: 8			Box Qty: 4
Chevrolet	Blazer		1969	Mercedes-Benz	C63 AMG		2015-2008
	Corvette		1969		CL63 AMG		2010-2008
	P30 Series		1962		CLK63 AMG		2009-2007
	P30 Series		1965-1964		CLS63 AMG		2011-2007
					E63 AMG		2011-2007
Nissan	320		1965-1961		ML63 AMG		2011-2007
	411		1967-1966		R63 AMG		2007
	520 Pickup		1968-1965		S63 AMG		2010-2008
Volkswagen	Campmobile		1974-1972		SL63 AMG		2012-2009
	Transporter		1979-1972				
	Vanagon		1983-1980				
<b>5874</b>		<b>PFR6U-11G</b>	<b>Laser Platinum</b>	<b>6046</b>		<b>DCPR7EIX</b>	<b>Iridium IX</b>
Qty per Vehicle: 6			Box Qty: 4	Qty per Vehicle: 4			Box Qty: 4
Audi	A4		2005-2002	Chevrolet	Spark		2015-2013
	A4 Quattro		2006-2002		Fiat	500	
	A6		2004-2002				
	A6 Quattro		2004-2002				
<b>5877</b>		<b>BR7ET</b>	<b>Standard</b>	<b>6130</b>		<b>BCPR5ES</b>	<b>Standard</b>
Qty per Vehicle: 4			Box Qty: 4	Qty per Vehicle: 4-6			Box Qty: 4
Mazda	Cosmo		1978-1976	Geo	Prizm		1992-1990
	R100		1972-1970	Saab	900		1994-1992
	Rotary Pickup		1977-1974	Toyota	4Runner		1988
	RX-2		1974-1971		Celica		1993-1988
	RX-3		1978-1972		Corolla		1992-1988
	RX-4		1978-1974				
RX-7		1979					
<b>5887</b>		<b>IZFR5G</b>	<b>Laser Iridium</b>	<b>6176</b>		<b>DILFR6D11</b>	<b>Laser Iridium</b>
Qty per Vehicle: 4			Box Qty: 4	Qty per Vehicle: 6			Box Qty: 4
Jeep	Compass		2011-2007	Lexus	ES350		2017-2007
	Patriot		2011-2007		RX350		2015-2007
					RX450h		2015-2010
<b>5944</b>		<b>BPR7HIX</b>	<b>Iridium IX</b>	Toyota	Avalon		2017-2005
Qty per Vehicle: 4			Box Qty: 4		Camry		2017-2007
Porsche	912		1969-1965		Highlander		2016-2008
Volvo	122		1968-1967		RAV4		2012-2006
	142		1968		Sienna		2016-2007
	144		1968-1967		Venza		2016-2009
	145		1968				
	1800		1967				
	1800		1972-1970				
<b>5960</b>		<b>ZFR6T-11G</b>	<b>Standard</b>	<b>6215</b>		<b>SILZKR6B11</b>	<b>Laser Iridium</b>
Qty per Vehicle: 4-5			Box Qty: 4	Qty per Vehicle: 4-6			Box Qty: 4
Volkswagen	Beetle		2010-2008	Hyundai	Elantra		2011
	Beetle		2014-2012		Genesis		2009
	Golf		2014-2010	Kia	Borrego		2011-2009
	Jetta		2015-2007				
	Passat		2014-2012				
<b>6222</b>		<b>BPR5HS</b>	<b>Standard</b>	Qty per Vehicle: 4-8			Box Qty: 10
Buick	Skylark		1964-1963	Jeep	Gladiator		1967-1963
	Special		1964-1961		J-100		1967-1963
	Sportwagon		1964		Tornado		1962
Jeep	Wagoneer		1967-1963	Oldsmobile	F85		1963-1961
					Jetfire		1963
					Renault	LeCar	
Renault	R10		1971-1970	Rover	3500S		1971-1969



6240	PLFR5A-11	Laser Platinum	
Qty per Vehicle: 4-8		Box Qty: 4	
Infiniti	FX35	2008-2003	
	FX45	2008-2003	
	G35	2007-2003	
	I35	2004-2002	
	M35	2008-2006	
	M45	2004-2003	
	M45	2010-2006	
	Q45	2006-2002	
Nissan	QX4	2003-2001	
	QX56	2006-2004	
	350Z	2006-2003	
	Altima	2006-2002	
	Armada	2006-2005	
	Frontier	2006-2005	
	Maxima	2008-2002	
	Murano	2007-2003	
	Pathfinder	2006-2001	
	Pathfinder Armada	2004	
Suzuki	Quest	2009-2004	
	Sentra	2006-2000	
	Titan	2006-2004	
	Xterra	2006-2005	
	X-Trail	2006-2005	
	Equator	2012-2009	
	<b>6261 BPR6EY-11 V-Power</b>		
	Qty per Vehicle: 3-6		Box Qty: 4
Chevrolet	Metro	1992	
	Metro	2000-1998	
	Sprint	1992-1987	
Chrysler	Conquest	1988-1987	
Dodge	2000 GTX	1990-1989	
	Challenger	1979-1978	
	Colt	1991-1979	
	Conquest	1986-1984	
	D50	1982-1979	
	Mini Ram	1986-1984	
	Power Ram 50	1986-1983	
	Raider	1989-1987	
	Ram 50	1993-1983	
Eagle	2000 GTX	1993-1991	
	Summit	1990-1989	
	Talon	1994-1990	
Ford	Aspire	1997-1994	
	Festiva	1993-1988	
Geo	Metro	1997-1989	
	Storm	1993-1990	
Honda	Accord	1985	
	Civic	1987-1985	
	Prelude	1987-1984	
Hyundai	Elantra	1995-1992	
	Excel	1994-1986	
	Scoupe	1992-1991	
	Sonata	1998-1989	
Isuzu	Amigo	1989	
	I-Mark	1989-1981	
	Impulse	1989-1983	
	Pickup	1991-1981	
	Stylus	1993-1991	
	Trooper	1987-1984	
Mazda	Mizer	1976	
Mitsubishi	Cordia	1988-1983	
	Diamante	1996-1992	
	Eclipse	1994-1990	
	Expo	1992	
	Galant	1992-1989	

6261 (Cont'd)	BPR6EY-11	V-Power	
Qty per Vehicle: 3-6		Box Qty: 4	
Mitsubishi	Galant	1994	
	Mighty Max	1996-1983	
	Mirage	1992-1985	
	Montero	1989-1986	
	Precis	1994-1987	
	Starion	1988-1983	
	Tredia	1988-1983	
	Van	1990-1987	
	Nissan	200SX	1979-1977
		280ZX	1983-1980
		510	1979-1978
610		1976-1975	
710		1977-1975	
810		1981-1980	
Maxima		1984-1981	
Pulsar NX		1984-1983	
Sentra		1988-1987	
Stanza		1983-1982	
Plymouth	Arrow	1980-1978	
	Arrow Pickup	1982-1979	
	Champ	1982-1979	
	Colt	1979-1976	
	Colt	1994-1981	
	Conquest	1986-1984	
	Horizon	1983	
	Laser	1994-1990	
	Sapporo	1979-1978	
	Turismo	1983	
	Pontiac	Firefly	1991-1987
		Firefly	2000-1994
Subaru	Brat	1987-1981	
	DL	1989-1980	
	GL	1989-1980	
	GL-10	1989-1985	
	GLF	1982-1980	
	Justy	1990-1987	
	Justy	1995	
	Loyale	1994-1990	
	RX	1989-1986	
	Standard	1987-1976	
	XT	1991-1985	
	Suzuki	Swift	1994-1989
<b>6262 BCPR6EY-N-11 V-Power</b>			
Qty per Vehicle: 4		Box Qty: 4	
Acura	Integra	1987-1986	
Honda	Prelude	1990-1988	
<b>6282 BCPR7ES Standard</b>			
Qty per Vehicle: 4		Box Qty: 4	
Saab	900	1988-1985	
	900	1990	
	900	1993	
	9000	1990-1986	
<b>6290 PFR6H-10 Laser Platinum</b>			
Qty per Vehicle: 4		Box Qty: 4	
Saab	9-3	2003-1999	
	9-5	2009-2000	
<b>6292 BKR6EKUE Standard</b>			
Qty per Vehicle: 8		Box Qty: 4	
Volkswagen	Passat	2004-2002	
<b>6334 ZGR5C V-Power</b>			
Qty per Vehicle: 4-6		Box Qty: 10	
American Motors	AMX	1980-1978	
	Concord	1980-1978	





6334 (Cont'd)		ZGR5C	V-Power	6341 (Cont'd)		BKR5EIX	Iridium IX	
Qty per Vehicle: 4-6			Box Qty: 10	Qty per Vehicle: 4-12			Box Qty: 4	
American Motors	Gremlin		1978-1977	Mitsubishi	Outlander		2010-2008	
	Matador		1978	Nissan	Quest		1998-1993	
	Pacer		1980-1978	Oldsmobile	Achieva		1994-1992	
	Spirit		1979	Peugeot	405		1991-1989	
Jeep	Cherokee		1980-1978	Pontiac	Grand Am		1994-1993	
	CJ5		1980-1978	Rolls-Royce	Corniche		2002-2000	
	CJ7		1980-1978		Silver Dawn		1997-1995	
	J10		1980-1978	Saturn	L300		2005-2001	
<b>6341</b>		<b>BKR5EIX</b>	<b>Iridium IX</b>					
Qty per Vehicle: 4-12			Box Qty: 4					
Bentley	Arnage		2009-2000		LS2		2000	
	Azure		2003-1996		LW2		2000	
	Azure		2008-2006		LW300		2003-2001	
	Brooklands		1998-1993		Vue		2003-2002	
	Continental		2003-1985	Scion	xA		2006-2004	
	Corniche		1984		xB		2006-2004	
	Eight		1984	Toyota	4Runner		2000-1989	
	Eight		1991-1986		Celica		1997-1994	
	Mulsanne		1992-1984		Corolla		1997-1993	
Turbo R		1998-1988	Echo			2005-2001		
Cadillac	Catera		2001-1997		Land Cruiser		1997-1993	
	Beretta		1994-1992		Pickup		1995-1988	
Dodge	Ram 2500		1996-1995		T100		1998-1993	
	Ram 3500		1997-1996	Tacoma		1999-1995		
Geo	Prizm		1997-1993	Volkswagen	Cabrio		2001-1995	
Jaguar	XJR		1997		Corrado		1995-1992	
Jeep	Cherokee		1990-1987		EuroVan		1997	
	Comanche		1990-1987		EuroVan		2001-1999	
	Wagoneer		1990-1987		EuroVan		2003	
Kia	Sportage		1995		Golf		1999-1994	
Lexus	LX450		1997-1996		Golf		2002-2001	
Mazda	Miata		2005-2004	Jetta		2002-1993		
Mercedes-Benz	300CE		1993-1990	Passat		1997-1993		
	300E		1993	<b>6364</b>		<b>BKR6ES</b>	<b>Standard</b>	
	300SE		1993-1992	Qty per Vehicle: 4-8			Box Qty: 4	
	300SL		1993-1990	Alfa Romeo	164		1995-1991	
	300TE		1993	Audi	90 Quattro		1992-1990	
	400E		1993-1992		Coupe Quattro		1991-1990	
	400SE		1992	S8		2003		
	400SEL		1993	Chrysler	Cirrus		2000	
	500E		1993-1992		Neon		2002-2000	
	500SEC		1993	Dodge	Neon		2005-1995	
	500SEL		1993-1992		Stratus		2000-1995	
	500SL		1993-1990		SX 2.0		2005-2003	
	600SEC		1993	Geo	Prizm		1992-1990	
	600SEL		1993-1992	Tracker		1997-1994		
	600SL		1993	Hyundai	Scoupe		1995-1993	
	C36 AMG		1997-1995	Isuzu	Impulse		1992-1991	
	C220		1996-1994	Jaguar	Vanden Plas		1996-1988	
	C230		1998-1997		XJ6		1997-1987	
	C280		1997-1994		XJR		1996-1995	
	E320		1997-1994	XJS		1996-1992		
	E420		1995-1994	Kia	Rio		2002-2001	
	E420		1997		Sephia		2001-1998	
	E500		1994	Spectra		2004-2000		
	S320		1999-1994	Lotus	Elan		1990	
	S420		1997-1994		Elan		1992	
	S500		1997-1994	Mitsubishi	Eclipse		1998-1995	
	S600		1997-1994		Eclipse		2003	
SL320		1997-1994	Eclipse			2012-2006		
SL500		1997-1994	Galant			2009-2007		
SL600		1997-1994	Montero		2006-2003			
Mercury	Villager		1998-1993	Nissan	D21		1994-1990	
	Mitsubishi	Eclipse			2005-2004	Pathfinder		1995-1990
		Lancer			2010-2009	Pickup		1995
Plymouth	Breeze		2000-1996	Plymouth	Breeze		2000-1996	
	Neon		2001-1995		Neon		2001-1995	



6364 (Cont'd)	BKR6ES	Standard
Qty per Vehicle: 4-8		Box Qty: 4
Pontiac	Sunrunner	1997-1995
Porsche	911	2009-2007
	Cayenne	2006-2003
Saab	9-2X	2005
Subaru	Impreza	2005-2002
Suzuki	Esteem	2000-1995
	Sidekick	1998-1993
	Swift	1993-1992
	X-90	1998-1996
Toyota	Celica	1993-1990
	Corolla	1992-1990
	MR2	1995-1991
	Sequoia	2004-2001
Volvo	Tundra	2004-2000
	Golf	1986
	Golf	1993-1990
	Jetta	1992-1990
Volvo	Passat	1991-1990
	850	1997-1993
	960	1994-1992
	C70	2004-1998
Volvo	S40	2004-2000
	S60	2009-2001
	S70	2000-1998
	S80	2006-1999
	V40	2004-2000
	V70	2007-1998
	XC70	2007-2003
	XC90	2006-2003

6371	FR5AP-10	Laser Platinum
Qty per Vehicle: 4-6		Box Qty: 4
Infiniti	QX4	2000-1998
Nissan	Altima	1999
	Frontier	2000-1999
	Pathfinder	2000-1998
	Quest	2000-1999
	Xterra	2000

6376	LFR5A-11	V-Power
Qty per Vehicle: 4-16		Box Qty: 4
Hyundai	Genesis	2009
	Santa Fe	2009-2007
Infiniti	FX35	2008-2003
	FX45	2008-2003
	G35	2007-2003
	I35	2004-2002
	M35	2008-2006
	M45	2004-2003
	M45	2010-2006
	Q45	2006-2002
Kia	QX4	2003-2001
	QX56	2006-2004
	Borrego	2009
	Magentis	2010-2007
Kia	Optima	2010-2006
	Rondo	2012-2007
	350Z	2006-2003
Nissan	Altima	2006-2002
	Armada	2006-2005
	Frontier	2006-2005
	Maxima	2008-2002
	Murano	2007-2003
	Pathfinder	2006-2001
	Pathfinder Armada	2004
	Quest	2009-2004

6376 (Cont'd)	LFR5A-11	V-Power
Qty per Vehicle: 4-16		Box Qty: 4
Nissan	Sentra	2006-2000
	Titan	2006-2004
	Xterra	2006-2005
	X-Trail	2006-2005
Ram	2500	2015-2014
	3500	2015-2014
	4500	2014
	5500	2014
Scion	tC	2016-2011
Suzuki	Equator	2012-2009
Toyota	4Runner	2017-2013
	Camry	2017-2010
	FJ Cruiser	2014-2013
	Highlander	2017-2009
	RAV4	2017-2009
	Sienna	2013-2011
	Tundra	2014-2013
	Venza	2016-2009

6378	PMR8B	Laser Platinum
Qty per Vehicle: 8-12		Box Qty: 4
Ferrari	360	2005
	599 GTB	2010-2007
	599 GTO	2011
	Enzo	2004-2003
Maserati	F430	2009-2006
	Coupe	2006-2005
	GranSport	2006-2005
	Quattroporte	2007-2004
	Spyder	2006-2005

6418	BKR6EIX	Iridium IX
Qty per Vehicle: 4-24		Box Qty: 4
Alfa Romeo	164	1995-1991
Audi	90 Quattro	1992-1990
	5000	1987
	5000 Quattro	1988-1986
	A4	2006-1996
	A4 Quattro	2005-1996
	A6	2001-1998
	A6 Quattro	1996-1995
	A6 Quattro	2004-1998
	A8 Quattro	2006-1997
	Allroad Quattro	2005-2001
	Cabriolet	1996-1995
	Coupe Quattro	1991-1990
	S4	2002-2000
	S4	2009-2004
S6	2003-2002	
S8	2003-2001	
TT	2002-2000	
TT	2006-2004	
TT Quattro	2006-2000	
Bentley	Arnage	1999
BMW	318i	1999-1991
	318is	1999-1991
	318ti	1999-1995
	320i	1995-1992
	320i	2005-2001
	323Ci	2000
	323i	2000-1998
	323is	1999-1998
	325Ci	2006-2001
	325i	1995-1992
325i	2005-2001	
325is	1995-1992	



6418 (Cont'd)	BKR6EIX	Iridium IX	6418 (Cont'd)	BKR6EIX	Iridium IX	
Qty per Vehicle: 4-24		Box Qty: 4	Qty per Vehicle: 4-24		Box Qty: 4	
BMW	325xi	2005-2001	Mercedes-Benz	C230	2002	
	328Ci	2000		CL65 AMG	2006-2005	
	328i	2000-1996		CL65 AMG	2014-2008	
	328is	1999-1996		CL600	2014-2003	
	330Ci	2006-2001		G65 AMG	2017-2016	
	330i	2005-2001		Maybach S600	2017-2016	
	330xi	2005-2001		S65 AMG	2013-2006	
	525i	1995-1991		S65 AMG	2017-2015	
	525i	2005-2001		S600	2013-2003	
	525iT	1993		S600	2017-2015	
	528i	2000-1997		SL65 AMG	2011-2005	
	530i	1995-1994		SL65 AMG	2017-2013	
	530i	2005-2001		SL600	2011-2004	
	540i	1995-1994		SLK32 AMG	2002	
	540i	2003-1997		SLK230	2002-2001	
	545i	2005-2004	Mini	Cooper	2006-2002	
	645Ci	2005-2004	Mitsubishi	Eclipse	1998-1995	
	740i	1995-1993		Eclipse	2012-2003	
	740i	2001-1997		Endeavor	2008-2004	
	740iL	2001-1993		Endeavor	2011-2010	
	745i	2005-2002		Galant	2009-2004	
	745Li	2005-2002		Lancer	2010-2008	
	750iL	2001-1998		Montero	2006-2003	
	760i	2006-2004	Morgan	Aero 8	2005-2004	
	760Li	2008-2003	Nissan	D21	1994-1990	
	840Ci	1997-1994		Pathfinder	1995-1990	
	M3	1999-1994		Pickup	1995	
	M5	2003-2000	Plymouth	Breeze	2000-1996	
	X3	2006-2004		Neon	2001-1995	
	X5	2006-2000	Pontiac	Sunrunner	1997-1995	
Z3	2002-1996	Porsche		911	1994-1990	
Z4	2005-2003		911	1997-1996		
Z8	2003-2000		911	2005-1999		
Cadillac	CTS		2004-2003	911	2009-2007	
	ELR		2016-2014	Boxster	2004-1997	
Chevrolet	Cobalt		2007-2005	Carrera GT	2005-2004	
	Cruze	2015-2011	Cayenne	2006-2003		
	Cruze Limited	2016	Rolls-Royce	Park Ward	2002	
	Optra	2007-2004	Phantom	2013-2004		
	Sonic	2017-2012	Silver Seraph	2002-1999		
Chrysler	Volt	2015-2011	Saab	9-2X	2005	
	Cirrus	2000		900	1997-1994	
Daewoo	Neon	2002-2000		9000	1997-1995	
	Leganza	2002-1999	Saturn	Ion	2007-2004	
Dodge	Neon	2005-1995	Subaru	Impreza	2005-2002	
	Stratus	2000-1995		Suzuki	Esteem	2000-1995
	SX 2.0	2005-2003	Forenza		2008-2004	
Geo	Prizm	1992-1990	Reno		2008-2005	
	Tracker	1997-1994	Sidekick		1998-1993	
Hyundai	Scoupe	1995-1993	Swift		1993-1992	
	Impulse	1992-1991	Verona		2004	
Jaguar	Vanden Plas	1996-1988	X-90		1998-1996	
	XJ6	1997-1987	Toyota	Celica	1993-1990	
	XJR	1996-1995		Corolla	1992-1990	
XJS	1996-1992	MR2		1995-1991		
Kia	Rio	2002-2001		Sequoia	2004-2001	
	Sephia	2001-1998		Tundra	2004-2000	
	Spectra	2004-2000		Volkswagen	Beetle	2005-1999
Land Rover	Range Rover	2005-2003	Cabrio		2002	
	Lotus	Elan	1990		Golf	1986
		Elan	1992		Golf	1993-1990
Maybach	Esprit	2003-1997	Golf		2006-2000	
	57	2012-2003	Jetta		1992-1990	
Mercedes-Benz	62	2012-2003	Jetta		2005-2000	
	C32 AMG	2002	Passat		1991-1990	



6418 (Cont'd)		BKR6EIX	Iridium IX	6427 (Cont'd)		BPR6EY	V-Power	
Qty per Vehicle: 4-24			Box Qty: 4	Qty per Vehicle: 2-12			Box Qty: 4	
Volkswagen	Passat		2005-1998	BMW	2000c		1969-1968	
	Phaeton		2006-2004		2000cs		1969-1968	
	Touareg		2007-2004		2000ti		1971-1968	
Volvo	850		1997-1993		2000tii		1972-1969	
	960		1997-1992		2002		1976-1966	
	C70		2004-1998		2002ti		1971-1968	
	S40		2004-2000		2002tii		1974-1971	
	S60		2009-2001		2800CS		1971-1968	
	S70		2000-1998		Buick	Opel		1979-1976
	S80		2006-1999		Citroen	SM		1975-1971
	S90		1998-1997		Daewoo	Lanos		2002-1999
	V40		2004-2000	Dodge	Colt		1980-1971	
	V70		2007-1998	Eagle	Talon		1994-1990	
	V90		1998-1997	Fiat	124		1981-1967	
XC70		2007-2003	128			1979-1971		
XC90		2006-2003	131			1978-1975		
<b>6422</b>			<b>BPR7HS</b>		<b>Standard</b>			
Qty per Vehicle: 4			Box Qty: 4					
Porsche	912		1969-1965		Honda	600		1972-1969
Volvo	122		1968-1967			Civic		1979-1973
	142		1968		Hyundai	Pony		1987-1983
	144		1968-1967			Stellar		1987-1985
	145		1968		Jaguar	XJ12		1979-1973
	1800		1967			XJS		1976
1800		1972-1970	XJS			1979		
<b>6427</b>			<b>BPR6EY</b>			<b>V-Power</b>		
Qty per Vehicle: 2-12			Box Qty: 4					
Alfa Romeo	2600		1967	Jensen	Healey		1976-1972	
	Alfetta		1977-1975	Lada	1300		1983	
	GTV-6		1986-1981		Niva		1993-1984	
	Milano		1989-1987		Samara		1993-1988	
	Montreal		1975-1971		Signet		1993-1984	
	Sport		1979-1978	Lancia	Beta		1979-1976	
	Sprint		1979-1977		Beta		1981	
Aston Martin	DB4		1963-1958		Zagato		1979	
	DB5		1965-1963	Zagato		1982-1981		
	DB6		1970-1965	Land Rover	Discovery		1999-1994	
	DBS		1971-1967	Lotus	Eclat		1979-1976	
	Lagonda		1978-1977		Elite		1966-1958	
	V-8		1978-1972		Esprit		1979-1976	
	V-8		1982		Esprit		1989-1982	
Vantage		1974-1972	Seven			1975-1962		
Audi	100 Series		1971-1969		Super Seven		1968-1962	
	4000		1983-1980	Maserati	Bora		1983-1971	
	5000		1983-1978		Ghibli		1973-1967	
	5000		1988-1985		Indy		1974-1969	
	5000 Quattro		1986		Khamsin		1979-1974	
	Coupe		1987-1981		Merak		1982-1972	
	Super 90		1972-1969		Mexico		1971-1967	
Austin	America		1972-1968		Quattroporte		1969-1968	
	Marina		1975-1973	Quattroporte		1986-1979		
	Mini		1966-1960	Mazda	616		1971-1970	
	Mini 850		1966-1960		618		1972	
Mini Cooper		1969-1962	626			1987-1986		
Austin Healey	3000		1967-1959		808		1977-1972	
	Sprite		1970-1962		1800		1971-1970	
Bertone	X-1/9		1989-1984		B1600		1976-1972	
BMW	1600		1971-1964		B1800		1978-1977	
	1600-2		1971-1966		GLC		1978-1977	
	1600ti		1968-1966		Mizer		1977-1976	
	1602		1971-1967		Mercedes-Benz	200		1967-1966
	1800		1971-1968			220		1973-1968
	1802		1971	230			1969-1966	
	2000		1972-1966	230S			1967-1966	
				230SL			1966-1963	



6427 (Cont'd)		BPR6EY	V-Power	6427 (Cont'd)		BPR6EY	V-Power	
Qty per Vehicle: 2-12			Box Qty: 4	Qty per Vehicle: 2-12			Box Qty: 4	
Mercedes-Benz	250		1972-1968	Saab	900		1984-1979	
	250C		1972-1970		900		1986	
	250S		1967-1966		Monte Carlo		1967	
	250SE		1967-1966		Sonett		1974-1968	
	250SL		1967		Subaru	Brat		1980-1978
	280		1974-1973			Deluxe		1973-1972
	280C		1974-1973			DL		1979-1974
	280S		1971-1968			FE		1979
	280SE		1973-1968			GF		1979-1975
	280SEL		1973-1968			GL		1975-1972
	280SL		1971-1968			GL		1980-1979
	300SEL		1973-1968			GLF		1980
	350SL		1972		Star		1972-1971	
	600		1972-1967		Suzuki	Forsa		1988-1985
	MG	MGB				1981-1962	SA310	
MGC			1969-1968	Toyota	2000GT		1970-1967	
Midget		1974-1967	Celica			1974-1971		
Mitsubishi	Eclipse		1994-1990		Corona		1971-1967	
	Galant		1992-1991		Crown		1966-1964	
	Mirage		1989		Land Cruiser		1966-1965	
Morgan	4/4		1981-1980		Pickup		1970-1969	
	Plus 8		1996-1976		Stout		1968-1966	
Morris	Minor		1971-1970	Triumph	TR6		1976-1969	
Nissan	200SX		1983-1980		TR250		1968	
	240Z		1973-1970	Volkswagen	411		1972-1971	
	260Z		1975-1974		412		1974-1973	
	510		1981-1980		Cabriolet		1993-1985	
	610		1976-1974		Corrado		1992-1990	
	620		1979-1975		Dasher		1980-1975	
	710		1976-1974		Golf		1986-1985	
	720		1986-1980		Golf		1992-1988	
	B210		1974		Jetta		1984-1980	
	D21		1989-1986		Quantum		1987-1982	
	Pathfinder		1988-1987		Rabbit		1984-1980	
	Van		1988-1987		Rabbit Convertible		1984-1980	
	Peugeot	404			1970-1961	Rabbit Pickup		1983-1980
		504			1979-1970	Scirocco		1983-1980
		505			1987-1980	Volvo	240	
505			1991-1990		242			1984-1976
Plymouth	Arrow		1977-1976	244			1989-1976	
	Colt		1980	245			1989-1976	
	Cricket		1973-1971	264			1981-1980	
	Laser		1994-1990	740			1992-1985	
Porsche	911		1973-1972	745			1985	
	911		1989-1984	760			1987	
	911		1992-1991	780			1991-1989	
	912		1976	940			1995-1991	
	924		1988-1987	<b>6441 ZFR6FIX-11 Iridium IX</b>				
	928		1991-1983	Qty per Vehicle: 4-10				
	928		1995-1993	Box Qty: 4				
	944		1991-1985	Acura	CL		2003-2001	
968		1995-1992	EL			2005-2001		
Renault	Alliance		1987-1985		TL		2003-2002	
	Encore		1986-1985	BMW	550i		2010-2006	
	Fuego		1983-1982		650i		2010-2006	
	R5		1986		750i		2008-2006	
	R12		1977-1975		750Li		2008-2006	
	R15		1976-1975		X5		2010-2004	
	R17		1979-1975	Chevrolet	Aveo		2011-2009	
	R18		1981		Aveo5		2011-2009	
	R18i		1983-1981	Chrysler	Aspen		2007	
	Rover	3500			1980	Dodge	B1500	
Saab		95		1973-1968	B2500			1998-1997
		96		1973-1967	B3500			1998-1997
	99		1980-1969	Colt			1992	
				Dakota			2010-1997	





<b>6441 (Cont'd)</b>		<b>ZFR6FIX-11</b>	<b>Iridium IX</b>
Qty per Vehicle: 4-10			Box Qty: 4
Dodge	Durango		2009-1998
	Nitro		2011-2007
	Ram 1500		2010-1997
	Ram 1500 Van		2003-1999
	Ram 2500		2003-1997
	Ram 2500 Van		2003-1999
	Ram 3500		2003-1997
	Ram 3500 Van		2003-1999
Ford	Probe		1997-1989
Honda	Civic		2005-2001
	CR-V		2001-1999
	Prelude		2001-1992
Jeep	Commander		2010-2006
	Grand Cherokee		2010-1999
	Liberty		2012-2002
Mazda	626		1992-1990
	MX-6		1992-1990
	Protege		2003
Mitsubishi	Raider		2009-2006
Plymouth	Colt		1992
Pontiac	G3		2010-2009
	G3 Wave		2009
Ram	1500		2013-2011
	Dakota		2011
Suzuki	Swift+		2009
<b>6458</b>		<b>PFR6Q</b>	<b>Laser Platinum</b>
Qty per Vehicle: 4-6			Box Qty: 4
Audi	5000		1987
	5000 Quattro		1988-1986
	A4		2006-1996
	A4 Quattro		2005-1996
	A6 Quattro		1996-1995
	A6 Quattro		2004-2000
	Allroad Quattro		2005-2001
	Cabriolet		1996-1995
	S4		2002-2000
	TT		2002-2000
	TT		2006-2004
	TT Quattro		2006-2000
Volkswagen	Beetle		2005-1999
	Cabrio		2002
	Golf		2006-2000
	Jetta		2005-2000
	Passat		2005-1998

<b>6481 (Cont'd)</b>		<b>ILFR6B</b>	<b>Laser Iridium</b>
Qty per Vehicle: 4-6			Box Qty: 4
Volvo	XC90		2011-2007
<b>6490</b>		<b>LFR6D</b>	<b>Standard</b>
Qty per Vehicle: 5			Box Qty: 4
Volvo	C30		2010-2007
	S40		2010-2004
	V50		2010-2005
<b>6507</b>		<b>IFR6B</b>	<b>Laser Iridium</b>
Qty per Vehicle: 4-6			Box Qty: 4
Alfa Romeo	164		1995-1991
Mitsubishi	Eclipse		2003
	Montero		2006-2003
Porsche	911		2009-2007
Volvo	850		1997-1995
	C70		2004-1998
	S40		2004-2000
	S60		2009-2001
	S70		2000-1998
	S80		2006-1999
	V40		2004-2000
	V70		2007-1998
	XC70		2007-2003
	XC90		2006-2003
<b>6509</b>		<b>LTR6IX-11</b>	<b>Iridium IX</b>
Qty per Vehicle: 4-16			Box Qty: 4
Buick	Allure		2008-2005
	Allure		2010
	Enclave		2017-2008
	LaCrosse		2008-2005
	LaCrosse		2016-2010
	Rendezvous		2006-2004
Cadillac	ATS		2015-2013
	CTS		2015-2004
	SRX		2016-2004
	STS		2011-2005
	XTS		2017-2013
Chevrolet	Camaro		2015-2010
	Caprice		2017-2012
	Captiva Sport		2012
	Colorado		2016-2015
	Equinox		2017-2008
	Impala		2017-2012
	Impala Limited		2016-2014
	Malibu		2012-2008
	Traverse		2017-2009
	Ford	E-350 Super Duty	
Edge			2017-2011
Explorer			2017-2011
F-150			2017-2010
F-250 Super Duty			2017-2011
F-350 Super Duty			2017-2011
Fiesta			2015-2011
Flex			2017-2012
Focus			2017-2012
Fusion			2018-2013
Mustang			2017-2011
Police Interceptor Sedan			2017-2013
Police Interceptor Utility			2017-2013
Taurus			2017-2012
Transit-150			2017-2015
Transit-250			2017-2015
Transit-350			2017-2015
Transit-350 HD			2017-2015
GMC	Acadia		2016-2007
	Acadia Limited		2017



6509 (Cont'd)		LTR6IX-11	Iridium IX	6578 (Cont'd)		BPR4ES SOLID	Standard
Qty per Vehicle: 4-16			Box Qty: 4	Qty per Vehicle: 1-8			Box Qty: 4
GMC	Canyon		2016-2015	Bentley	T2 Series		1980-1977
	Terrain		2017-2010		Buick	Skylark	
Jaguar	XE		2017			Special	
	XF		2015-2013	Cadillac	Calais		1974-1968
Land Rover	Discovery Sport		2016-2015		DeVille		1974-1968
	LR2		2015-2013		Eldorado		1974-1968
	Range Rover Evoque		2016-2012		Fleetwood		1974-1968
Lincoln	Continental		2017	Checker	Marathon		1969-1968
	MKS		2016-2014	Chevrolet	Bel Air		1961-1958
	MKT		2017-2012		Bel Air		1969-1963
	MKX		2017-2011		Biscayne		1961-1958
	MKZ		2016-2013		Biscayne		1969-1963
Mazda	3		2009-2007		Blazer		1969
	6		2007-2006		Brookwood		1969
	6		2013-2009		C10 Pickup		1969-1963
	CX-7		2009-2007		C10 Suburban		1969-1968
	CX-9		2015-2007		C20 Pickup		1969-1963
	MX-5 Miata		2015-2006		C20 Suburban		1969-1968
Pontiac	G6		2009-2007	C30 Pickup		1969-1964	
	G8		2009-2008	Camaro		1969-1967	
	Solstice		2007	Caprice		1969-1967	
	Torrent		2009-2008	Chevelle		1969-1964	
Saab	9-4X		2011	Chevy II		1968-1962	
Saturn	Aura		2009-2007	El Camino		1960-1959	
	Outlook		2010-2007	El Camino		1969-1964	
	Vue		2010-2008	G10 Van		1969-1964	
Suzuki	Grand Vitara		2010-2009	G20 Van		1969-1967	
	XL-7		2009-2007	Impala		1961-1959	
<b>6510</b>		<b>LTR7IX-11</b>	<b>Iridium IX</b>				
Qty per Vehicle: 6			Box Qty: 4				
Cadillac	CT6		2017-2016				
	CTS		2014				
	XTS		2015-2014				
<b>6546</b>		<b>DCPR8EIX</b>	<b>Iridium IX</b>				
Qty per Vehicle: 6-12			Box Qty: 4				
BMW	M3		2006-2001				
	Z3		2002-2001				
	Z4		2008-2006				
Lamborghini	Diablo		1990				
<b>6569</b>		<b>FR5AP-11E</b>	<b>Laser Platinum</b>				
Qty per Vehicle: 8			Box Qty: 4				
Ford	Thunderbird		2005-2002				
Lincoln	LS		2006-2003				
<b>6578</b>		<b>BPR4ES SOLID</b>	<b>Standard</b>				
Qty per Vehicle: 1-8			Box Qty: 4				
American Motors	Ambassador		1974-1965	Chrysler	300		1958-1955
	American		1968-1964		Cordoba		1983-1975
	AMX		1970-1968		Daytona		1993-1984
	AMX		1979-1978		Dynasty		1993-1988
	Classic		1966-1964		E Class		1984-1983
	Concord		1979-1978		Fifth Avenue		1989-1983
	Gremlin		1977-1970		Imperial		1958-1957
	Hornet		1977-1970		Imperial		1982-1981
	Javelin		1974-1968		Laser		1986-1984
	Marlin		1967-1965		LeBaron		1994-1977
	Matador		1978-1971		Nassau		1955
	Pacer		1979-1975		Newport		1958-1955
	Rambler		1969		Newport		1972-1971
	Rebel		1970-1967		Newport		1981-1974
	Spirit		1979		New Yorker		1958-1956
	Bentley	Corniche			1980-1971	New Yorker	
Corniche			1983-1982	St Regis		1956	
Mulsanne			1983-1981	TC Maserati		1989	
T1 Series			1976-1968	Town & Country		1958-1955	
				Dodge	330		1964



6578 (Cont'd)	BPR4ES SOLID	Standard	6578 (Cont'd)	BPR4ES SOLID	Standard	
Qty per Vehicle: 1-8		Box Qty: 4	Qty per Vehicle: 1-8		Box Qty: 4	
Dodge	400	1983-1982	Dodge	Spirit	1995-1989	
	600	1988-1983		St. Regis	1981-1979	
	A100	1966-1964		W100	1977-1975	
	A100	1970		W100	1989-1984	
	A100 Truck	1970-1964		W100 Pickup	1974-1968	
	A108 Van	1970-1967		W100 Series	1967-1961	
	Aries	1989-1981		W150	1991-1977	
	Aspen	1980-1976		W200	1980-1975	
	B100	1980-1975		W200 Pickup	1974-1969	
	B100 Van	1974-1971		W200 Series	1967-1961	
	B150	1991-1981		W250	1992-1981	
	B200	1980-1975		W300	1980-1975	
	B200 Van	1974-1971		W300 Pickup	1974-1968	
	B250	1992-1981		W300 Series	1967-1963	
	B300	1980-1975		W350	1992-1981	
	B300 Van	1974-1971		GMC	1000 Series	1965-1964
	B350	1992-1981			1500 Series	1965-1964
	Caravan	1995-1984			C15/C1500 Pickup	1969-1967
	CB300	1980-1974			C15/C1500 Suburban	1969-1968
	Challenger	1974-1970			C25/C2500 Pickup	1969-1967
	Charger	1978-1967			C25/C2500 Suburban	1969-1968
	Charger	1987-1983			C35/C3500 Pickup	1969-1967
	Coronet	1958-1957			G15/G1500 Van	1969-1967
	Coronet	1976-1965			G25/G2500 Van	1969-1967
	Custom	1958-1957			G1000 Series	1966-1964
	D100	1979-1975			K15/K1500 Pickup	1969-1967
	D100	1989-1984			K15/K1500 Suburban	1969-1968
	D100 Pickup	1974-1968			K25/K2500 Pickup	1969-1967
	D100 Series	1967-1961			K25/K2500 Suburban	1969-1968
	D150	1991-1977			K35/K3500 Pickup	1969-1968
	D200	1980-1975	P15/P1500 Van		1969-1967	
	D200 Pickup	1974-1968	P25/P2500 Van		1967	
	D200 Series	1967-1961	P35/P3500 Van		1967	
	D250	1992-1981	PB15 Series		1966	
	D300	1980-1975	PB25 Series		1966	
	D300 Pickup	1974-1968	PB1000 Series	1965-1963		
	D300 Series	1967-1961	PB2500 Series	1963		
	D350	1992-1981	Suburban	1966-1963		
	D400	1981-1978	International	1000D	1970-1969	
	D450	1981-1978		1010	1971	
	Dakota	1995-1987		1100D	1970-1969	
	Dart	1976-1960		1110	1971	
	Daytona	1993-1984		1200D	1970-1969	
	Diplomat	1989-1977		1210	1971	
	Dynasty	1993-1988		1300D	1970-1969	
	Grand Caravan	1988		1310	1971	
	Lancer	1962-1961		M800	1971-1969	
Lancer	1989-1985	M800 Navy		1969		
Magnum	1979-1978	M800 Post Office		1971-1969		
Mini Ram	1988-1984	M1100		1971-1969		
Mirada	1983-1980	M1200		1971-1969		
Monaco	1978-1968	M1400	1969			
Omni	1990-1978	MA1200	1971-1969			
P100	1966-1965	Scout	1970-1969			
P100	1968	Scout II	1971			
P200	1966-1965	Jeep	Cherokee	1983-1974		
P200	1972-1968		CJ5	1981-1972		
P300	1972-1968		CJ6	1975-1972		
Polara	1964-1963		CJ7	1981-1976		
Polara	1973-1966		Commando	1973-1972		
Ramcharger	1992-1974		DJ5	1974-1972		
Rampage	1984-1982		Gladiator	1967-1965		
RD200	1980-1978		Grand Wagoneer	1991-1984		
Royal Monaco	1977-1975		J10	1988-1974		
Shadow	1994-1987		J20	1988-1974		



6578 (Cont'd)	BPR4ES SOLID	Standard	6578 (Cont'd)	BPR4ES SOLID	Standard
Qty per Vehicle: 1-8		Box Qty: 4	Qty per Vehicle: 1-8		Box Qty: 4
Jeep	J-100	1971-1965	Pontiac	Tempest	1965-1964
	J-2500	1973-1968		Tempest	1969-1967
	J-2600	1970-1968	Rolls-Royce	Camargue	1987-1975
	J-2600	1973-1972		Corniche	1983-1971
	J-2700	1969-1968		Phantom	1967-1960
	J-3500	1970-1968		Silver Cloud	1965-1955
	J-3600	1970-1968		Silver Shadow	1976-1966
	J-3700	1970-1968		Silver Shadow II	1980-1977
	J-3800	1968		Silver Spirit	1986-1981
Wagoneer	1983-1971	Silver Spur		1986-1981	
Mercury	Bobcat	1976-1975		Silver Wraith	1958-1955
Capri	1974-1971	Silver Wraith II	1980-1977		
Capri	1976				
Tracer	1990-1987				
Oldsmobile	Cutlass	1969-1968	<b>6579 PTR5F-11 Laser Platinum</b>		
	F85	1969-1966	Qty per Vehicle: 4-8		Box Qty: 4
	Firenza	1986-1982	Audi	V8 Quattro	1991-1990
Plymouth	Acclaim	1995-1989	Buick	Century	1988-1986
	Barracuda	1974-1964		Electra	1987-1986
	Belvedere	1970-1963		LeSabre	1988-1986
	Caravelle	1989-1978		Riviera	1987-1986
	Cuda	1974-1971		Roadmaster	1996-1994
	Custom	1958		Skylark	1988-1986
	Duster	1976-1970		Skylark	1995
	Expo	1989-1987		Somerset	1987-1986
	Fleet Special	1963-1960		Somerset Regal	1985
	Fury	1965	Cadillac	DeVille	2005-1994
	Fury	1978-1968		Eldorado	2002-1993
	Fury I	1974-1968		Fleetwood	1996-1994
	Fury II	1974-1968		Seville	2004-1993
	Fury III	1974-1968	Chevrolet	Camaro	1997-1993
	Grand Voyager	1988		Caprice	1996-1994
	Gran Fury	1977-1972		Cavalier	2002-1998
	Gran Fury	1989-1980		Corvette	1996-1992
	GTX	1971-1967		Impala	1996-1994
	Horizon	1990-1978		Lumina	1995-1991
	PB100	1980-1975		Malibu	1999
	PB100 Van	1974		Monte Carlo	1995
	PB150	1981	Vega	1976-1975	
	PB150	1983	DeLorean	DMC 12	1983-1981
	PB200	1980-1975		Eagle	Medallion
	PB200 Van	1974	Premier		1988
	PB250	1983-1981	Ford	Aerostar	1997-1986
	PB300	1980-1975		Bronco II	1990-1984
	PB300 Van	1974		Courier	1982-1977
	PB350	1983-1981		E-250	2005-2003
	Reliant	1989-1981		E-250 Econoline	2002-1997
	Road Runner	1975-1968		E-350 Club Wagon	2005-2003
	Satellite	1969-1965		E-350 Econoline	1998-1997
	Satellite	1974-1971		E-350 Econoline Club Wagon	2002-1997
	Savoy	1964		E-350 Super Duty	2005-1999
	Scamp	1976-1971		E-450 Econoline Super Duty	2002-2000
	Scamp	1983		Econoline Super Duty	1999
	Sundance	1994-1987		Escort	1985-1982
	Trailduster	1981-1974		EXP	1985-1982
	Turismo	1985		F-100	1983
	Valiant	1976-1964		F-150	1995-1993
	Volare	1980-1976		F-150	1998-1997
	Voyager	1995-1984		F-150	2003-2000
	Pontiac	Firebird	1969-1967	F-150	2010
		LeMans	1965-1964	F-150 Heritage	2004
		LeMans	1969-1967	F-250	1999-1997
		LeMans	1990-1989	Fairmont	1982-1978
		Optima	1990-1988	Fiesta	1980
Sunbird		1991-1989	Granada	1982-1981	
			LTD	1985-1983	
		Mustang	1986-1979		



6579 (Cont'd)	PTR5F-11	Laser Platinum
Qty per Vehicle: 4-8		Box Qty: 4
Ford	Mustang	2000
	Mustang II	1978-1974
	Pinto	1980-1974
	Probe	1992-1990
	Ranger	2009-1983
	Taurus	2007-1986
	Tempo	1989-1984
	Tempo	1994-1992
	Thunderbird	1988-1983
Windstar	2000-1995	
GMC	Yukon XL 1500	2008-2007
Lincoln	Town Car	2010-2006
Mazda	6	2008-2003
	B2300	1997-1994
	B2300	2010-2001
	B2500	2001-1998
	B3000	2003
Mercedes-Benz	190E	1993-1984
	260E	1989-1987
	300CE	1989-1988
	300E	1993-1986
	300SE	1991-1988
	300SEL	1991-1988
	300TE	1993-1988
	Mercury	Bobcat
Capri	1977-1976	
Capri	1984-1979	
Cougar	1981	
Cougar	1986-1984	
LN7	1983-1982	
Lynx	1982	
Lynx	1985-1984	
Marquis	1984-1983	
Sable	2005-1986	
Topaz	1988-1984	
Topaz	1994-1992	
Zephyr	1982-1978	
Merkur	Scorpio	1989-1988
	XR4Ti	1989-1985
Oldsmobile	98	1987-1986
	Alero	2001-1999
	Aurora	1999-1995
	Aurora	2003-2001
	Calais	1987-1985
	Cutlass Calais	1988
	Cutlass Ciera	1988-1986
	Cutlass Cruiser	1988-1987
	Cutlass Supreme	1995-1991
	Delta 88	1988-1986
	Toronado	1987-1986
Panoz	AIV Roadster	2000-1999
	Esperante	2002-2001
	Esperante	2005
Peugeot	505	1991-1987
Pontiac	Bonneville	1988-1987
	Firebird	1997-1993
	Grand Am	1987-1985
	Grand Am	2001-1999
	Grand Prix	1995-1991
	Sunfire	2002-1998
Volvo	262	1976
	262	1981-1978
	264	1982-1976
	265	1981-1976
	760	1990-1983

6579 (Cont'd)	PTR5F-11	Laser Platinum
Qty per Vehicle: 4-8		Box Qty: 4
Volvo	780	1990-1987
<b>6597</b>	<b>BPR5EIX</b>	<b>Iridium IX</b>
Qty per Vehicle: 3-12		Box Qty: 4
Aston Martin	Lagonda	1989-1979
	V-8	1989-1979
	Virage	1989
	Zagato	1988-1987
Asuna	Sunrunner	1992
Audi	4000	1980
	Fox	1979-1973
BMW	2.8 Bavaria	1971
	3.0CS	1974-1971
	3.0CSi	1974-1971
	3.0CSL	1971
	3.0S	1974-1971
	3.0Si	1971
	3.0Si	1976-1975
	318i	1985-1984
	320i	1983-1977
	528i	1981-1979
	530i	1978-1975
	533i	1984-1983
	535i	1988-1985
	535is	1988
	630CSi	1978-1977
	633CSi	1984-1978
635CSi	1987-1985	
733i	1984-1978	
735i	1987-1985	
2500	1971-1968	
2800	1974-1968	
Bavaria	1974-1972	
L6	1987	
Chrysler	Daytona	1987
Citroen	SM	1975-1973
Dodge	Coit	1975-1974
Geo	Tracker	1995-1989
Jaguar	3.8	1966-1960
	420	1967
	Mark X	1966-1962
	Vanden Plas	1987-1982
	XJ	1971-1969
	XJ6	1987-1972
	XJS	1978
	XK150	1961-1958
	XKE	1971-1961
	Land Rover	Defender 90
	Defender 90	1997
	Defender 110	1993
	Range Rover	2002-1987
Lotus	Elite	1979-1976
	Esprit	1982-1980
Mazda	626	1987-1979
	B2000	1984-1979
	B2000	1987-1986
	B2200	1993-1987
	GLC	1985-1979
Mercedes-Benz	230	1978-1974
	280	1976-1975
	280C	1976-1975
	280CE	1981-1978
	280E	1981-1977
	280S	1976-1975
	280SE	1980-1977
	380SE	1985-1984





6597 (Cont'd)	BPR5EIX	Iridium IX	6597 (Cont'd)	BPR5EIX	Iridium IX
Qty per Vehicle: 3-12		Box Qty: 4	Qty per Vehicle: 3-12		Box Qty: 4
Mercedes-Benz	380SEC	1983-1982	Volvo	760	1990-1988
	380SEL	1983-1981		DL	1984
	380SL	1985-1981		GLE	1984
	380SLC	1981	Yugo	Cabrio	1992-1990
	420SEL	1991-1986		GV	1992-1986
	450SE	1976-1973		GVL	1989-1988
	450SEL	1980-1973		GVS	1988
	450SL	1980-1973		GVX	1989-1988
	450SLC	1980-1973	<b>6612 BR8ET Standard</b>		
	500SEC	1985-1984	Qty per Vehicle: 4		Box Qty: 4
	500SEL	1985-1984	Mazda	RX-7	1980
	560SEC	1991-1986	<b>6619 LFR6AIX-11 Iridium IX</b>		
	560SEL	1991-1986	Qty per Vehicle: 4-16		Box Qty: 4
	560SL	1989-1986	Acura	ILX	2015-2013
	MG	Midget	1966-1962	BMW	128i
Midget		1979-1975	323i		2009-2006
Nissan	200SX	1983-1982	325i		2006
	720	1986-1981	325xi		2006
	1200	1973-1971	328i		2009-2007
	2000	1970-1968	328i xDrive		2009
	B210	1976-1975	328xi		2008-2007
	D21	1989-1986	330i		2006
	F10	1976	330xi		2006
	Pathfinder	1988-1987	525i		2007-2006
Van	1988-1987	525xi	2007-2006		
Pontiac	Sunrunner	1994	528i		2010-2008
Porsche	911	1979-1978	528i xDrive		2010-2009
	928	1982-1978	528xi		2008
	944	1984-1983	530i	2007-2006	
Renault	Alliance	1987-1983	530xi	2007-2006	
	Encore	1986-1984	X3	2009-2007	
	LeCar	1985-1980	X5	2009-2007	
Rolls-Royce	Corniche	1985-1984	Z4	2009-2006	
	Corniche II	1992-1986	Honda	Civic	2015-2006
	Silver Spirit	1991-1987		Insight	2014-2010
	Silver Spur	1991-1987	Lexus	ES350	2017-2007
Suzuki	LJ81	1981		GX460	2017-2010
	Samurai	1995-1985		LX570	2011-2008
	Sidekick	1994-1989		LX570	2017-2013
	SJ410	1985-1980		RX350	2015-2007
	SJ413	1985		RX450h	2015-2010
Toyota	4Runner	1995-1984	Mercedes-Benz	CL55 AMG	2006-2003
	Carina	1973-1972		CLS55 AMG	2006
	Celica	1985-1973		E55 AMG	2006-2003
	Corolla	1979-1968		G55 AMG	2011-2005
	Corona	1982-1972		S55 AMG	2006-2003
	Cressida	1981-1978		SL55 AMG	2008-2003
	Crown	1972-1967		SLR McLaren	2009-2005
	Land Cruiser	1974-1967	Saab	9-3	2009-2006
	Land Cruiser	1989-1979		Subaru	Legacy
	Mark II	1976-1972	Outback		2004-2001
	Pickup	1995-1970	Outback		2017-2010
	Starlet	1982-1981	Tribeca		2014-2010
	Van Wagon	1988	Suzuki	Grand Vitara	2012-2009
	Triumph	GT6		1973-1967	Kizashi
Spitfire		1980-1963	Toyota	4Runner	2013-2003
Stag		1973-1971		Avalon	2017-2005
TR7		1982-1975		Camry	2017-2007
TR8		1982-1980		FJ Cruiser	2013-2007
Volkswagen	Dasher	1980-1974		Highlander	2016-2008
	Rabbit	1980-1975		Land Cruiser	2011-2008
	Rabbit Convertible	1980		Land Cruiser	2017-2013
	Rabbit Pickup	1980		RAV4	2012-2006
	Scirocco	1980-1975		Sequoia	2016-2008
Volvo	760	1986-1984			



6619 (Cont'd)	LFR6AIX-11	Iridium IX
Qty per Vehicle: 4-16		Box Qty: 4
Toyota	Sienna	2016-2007
	Tacoma	2015-2005
	Tundra	2017-2005
	Venza	2016-2009
Volvo	C30	2010-2007
	S40	2010-2004
	V50	2010-2005
6630	UR4	V-Power
Qty per Vehicle: 4-8		Box Qty: 4
Buick	Apollo	1974-1973
	Centurion	1973-1971
	Century	1974-1973
	Century	1981-1977
	Commercial Chassis	1991
	Electra	1974-1967
	Estate Wagon	1974-1970
	Gran Sport	1967
	GS	1972-1970
	GS 350	1969-1968
	GS 400	1969-1968
	GS 455	1972-1970
	LeSabre	1974-1968
	LeSabre	1980-1978
	LeSabre	1982
	Regal	1974-1973
	Regal	1987-1977
	Riviera	1974-1967
	Riviera	1981-1979
	Riviera	1985-1984
	Roadmaster	1991
	Skylark	1972-1967
	Skylark	1979-1977
	Special	1969-1968
	Sportwagon	1972-1968
	Wildcat	1970-1967
	Cadillac	Brougham
Commercial Chassis		1993
Fleetwood		1993
Checker	Marathon	1974-1970
	Marathon	1978-1976
Chevrolet	Bel Air	1971
	Bel Air	1981
	Biscayne	1971
	Blazer	1971
	C10	1986-1976
	C10 Pickup	1971
	C10 Suburban	1971
	C10 Suburban	1986-1976
	C20	1986-1976
	C20 Pickup	1971
	C20 Suburban	1971
	C20 Suburban	1986-1976
	C30	1984-1976
	C30 Pickup	1971
	C70	1990
	Camaro	1971
	Camaro	1992-1975
	Caprice	1971
	Caprice	1993-1976
	Chevelle	1971
	Corvette	1971
	Corvette	1982-1976
	Corvette	1984
	Corvette	1991-1988
	El Camino	1971-1970

6630 (Cont'd)	UR4	V-Power
Qty per Vehicle: 4-8		Box Qty: 4
Chevrolet	El Camino	1985-1976
	El Camino	1987
	G10	1984-1976
	G10 Van	1971
	G20	1984-1976
	G20 Van	1971
	G30	1984-1976
	G30 Van	1971
	Impala	1971
	Impala	1985-1976
	K5 Blazer	1986-1976
	K10	1986-1976
	K10 Pickup	1971
	K10 Suburban	1971
	K10 Suburban	1983-1976
	K10 Suburban	1986-1985
	K20	1985-1976
	K20 Pickup	1971
	K20 Suburban	1971
	K20 Suburban	1986-1976
	K30	1980-1977
	K30	1984-1982
	K30 Pickup	1971
	Kingswood	1971-1970
	Laguna	1976
	Malibu	1983-1975
	Monte Carlo	1971-1970
	Monte Carlo	1988-1976
	Monza	1979-1976
	Nova	1971
	Nova	1979-1975
	P10	1979-1977
	P10 Van	1972-1971
	P20	1976
	P20	1984-1979
	P20 Van	1972-1970
	P30	1976
	P30	1984-1978
	P30 Van	1972-1970
	Townsmen	1971-1970
	Vega	1976
	Chrysler	Cordoba
Fifth Avenue		1983
LeBaron		1981-1978
Newport		1981-1979
New Yorker		1982
Town & Country		1981-1978
Aspen		1980-1976
Dodge	B100	1980-1975
	B100 Van	1974
	B150	1987-1981
	B200	1980-1975
	B200 Van	1974
	B250	1987-1981
	B300	1980-1975
	B300 Van	1974
	CB300	1975
	CB300	1979-1977
	Charger	1976
	Coronet	1976-1975
	D100	1979-1975
	D100	1987-1984
	D150	1987-1977
D200	1980-1975	
D250	1987-1981	



6630 (Cont'd)		UR4	V-Power	6630 (Cont'd)		UR4	V-Power
Qty per Vehicle: 4-8			Box Qty: 4	Qty per Vehicle: 4-8			Box Qty: 4
Dodge	D300		1978-1975	GMC	C25 Suburban		1978-1976
	Dart		1976-1975		C35		1978-1976
	Diplomat		1983-1978		C35/C3500 Pickup		1971
	Mirada		1983-1980		C1500		1986-1979
	Monaco		1978-1977		C1500 Suburban		1986-1979
	Ramcharger		1980-1975		C2500		1986-1979
	St. Regis		1981-1979		C2500 Suburban		1986-1979
	W100		1977-1975		C3500		1980-1979
	W100		1987-1984		C3500		1984-1982
	W150		1987-1978		C3500		1986
	W200		1980-1975		Caballero		1987-1978
	W250		1982-1981		G15		1978-1976
	W300		1978-1975		G15/G1500 Van		1971
	W350		1982		G25		1978-1976
Ford	Bronco		1988-1976	G25/G2500 Van		1971	
	Country Sedan		1974-1970	G35		1978-1976	
	Country Squire		1974-1970	G35/G3500 Van		1971	
	Custom		1972-1970	G1500		1984-1979	
	Custom 500		1976-1970	G2500		1984-1979	
	E-100 Econoline		1983-1975	G3500		1984-1979	
	E-100 Econoline Club Wagon		1983-1975	Jimmy		1971	
	E-150 Econoline		1988-1975	Jimmy		1983-1976	
	E-150 Econoline Club Wagon		1985-1975	Jimmy		1986-1985	
	E-250 Econoline		1988-1975	K15		1978-1976	
	E-250 Econoline Club Wagon		1991-1975	K15/K1500 Pickup		1971	
	E-350 Econoline		1996-1975	K15/K1500 Suburban		1971	
	E-350 Econoline Club Wagon		1996-1977	K15 Suburban		1978-1976	
	Econoline Super Duty		1996	K25		1978-1976	
	Elite		1976-1975	K25/K2500 Pickup		1971	
	F53		1996-1988	K25/K2500 Suburban		1971	
	F-100		1974-1973	K25 Suburban		1978-1976	
	F-100		1979-1976	K35		1978-1977	
	F-100		1982-1981	K35/K3500 Pickup		1971	
	F-150		1988-1975	K1500		1986-1979	
	F-250		1996-1973	K1500 Suburban		1984-1979	
	F-350		1996-1973	K2500		1985-1979	
	Fairlane		1970-1969	K2500 Suburban		1984-1979	
	Falcon		1970	K3500		1984-1979	
	F Super Duty		1988	P15/P1500 Van		1971	
	F Super Duty		1996-1990	P25		1976	
	Galaxie 500		1974-1969	P25/P2500 Van		1971-1970	
	Granada		1976-1975	P35		1976	
	Gran Torino		1976-1972	P35		1978	
	LTD		1976-1970	P35/P3500 Van		1971-1970	
	LTD		1986-1981	P1500		1979	
	LTD Crown Victoria		1991-1987	P2500		1984-1979	
	Maverick		1976-1975	P3500		1984-1979	
	Mustang		1973-1969	Sprint		1971	
	Mustang		1985-1984	Sprint		1977-1975	
	Mustang II		1976-1975	Jeep	J-100		1971-1969
	P-350		1976		J-2500		1971-1969
	P-400		1976		J-2600		1970-1969
	P-500		1977-1976		J-2700		1970-1969
	Ranchero		1977-1970		J-3500		1970-1969
Ranch Wagon		1974-1970	J-3600			1970-1969	
Thunderbird		1973-1972	J-3700			1970-1969	
Thunderbird		1976-1975	J-3800			1970-1969	
Torino		1976-1970	Wagoneer		1971		
GMC	C15		1978-1976	Lincoln	Continental		1976-1973
	C15/C1500 Pickup		1971		Mark IV		1976-1973
	C15/C1500 Suburban		1971	Mercury	Capri		1985-1984
	C15 Suburban		1978-1976		Colony Park		1974-1970
	C25		1978-1976		Comet		1976-1971
	C25/C2500 Pickup		1971		Cougar		1978-1969
C25/C2500 Suburban		1971	Cyclone		1971-1969		



6630 (Cont'd)	UR4	V-Power	6630 (Cont'd)	UR4	V-Power
Qty per Vehicle: 4-8		Box Qty: 4	Qty per Vehicle: 4-8		Box Qty: 4
Mercury	Grand Marquis	1976-1975	Pontiac	Ventura	1974-1971
	Grand Marquis	1978		Ventura	1977-1976
	Grand Marquis	1989-1983	<b>6637 BPR6EIX Iridium IX</b>		
	Marquis	1976-1971	Qty per Vehicle: 2-12		Box Qty: 4
	Marquis	1978	Alfa Romeo	2600	1967
	Monarch	1977-1975		Alfetta	1977-1975
	Montego	1976-1970		GTV-6	1986-1981
	Monterey	1974-1971		Milano	1989-1987
Oldsmobile	Custom Cruiser	1977		Montreal	1975-1971
	Custom Cruiser	1992-1991		Sport	1979-1978
	Cutlass	1971-1970	Sprint	1979-1977	
	Cutlass	1976	Aston Martin	DB4	1963-1958
	Cutlass	1981-1978		DB5	1965-1963
	Cutlass	1987-1985		DB6	1970-1965
	Cutlass Calais	1980-1978		DBS	1971-1967
	Cutlass Calais	1982		Lagonda	1978-1977
	Cutlass Cruiser	1980		V-8	1978-1972
	Cutlass Cruiser	1982	V-8	1982	
	Cutlass Salon	1980-1978	Vantage	1974-1972	
	Cutlass Supreme	1976	Audi	100 Series	1971-1969
	Cutlass Supreme	1980-1978		4000	1983-1980
	Cutlass Supreme	1982		4000 Quattro	1987-1986
	Delta 88	1977		5000	1983-1978
	Delta 88	1982-1981		5000	1988-1985
	F85	1971-1970		5000 Quattro	1986
	Omega	1974-1973	Coupe	1987-1981	
	Omega	1979-1976	Super 90	1972-1969	
	Starfire	1979-1977	Austin	America	1972-1968
Plymouth	Caravelle	1983-1978		Marina	1975-1973
	Duster	1976-1974		Mini	1966-1960
	Fury	1978-1975		Mini 850	1966-1960
	Gran Fury	1983-1980	Mini Cooper	1969-1962	
	PB100	1980-1975	Austin Healey	3000	1967-1959
	PB100 Van	1974		Sprite	1970-1962
	PB150	1983-1981	Bertone	X-1/9	1989-1984
	PB200	1978-1975	BMW	1600	1971-1964
	PB200	1980		1600-2	1971-1966
	PB200 Van	1974		1600ti	1968-1966
	PB250	1983-1981		1602	1971-1967
	Scamp	1976-1975		1800	1971-1968
	Trailduster	1980-1975		1802	1971
	Valiant	1976-1975		2000	1972-1966
	Volare	1980-1976		2000c	1969-1968
	Pontiac	Bonneville		1974-1972	2000cs
Bonneville		1986-1983		2000ti	1971-1968
Catalina		1974-1972		2000tii	1972-1969
Catalina		1981-1977		2002	1976-1966
Firebird		1974-1970		2002ti	1971-1968
Firebird		1985-1976		2002tii	1974-1971
Firebird		1992-1987	2800CS	1971-1968	
Grand Am		1974-1973	Buick	Opel	1979-1976
Grand Am		1980-1978	Citroen	SM	1975-1971
Grand LeMans		1982-1976	Daewoo	Lanos	2002-1999
Grand Prix		1974-1972	Dodge	Colt	1980-1971
Grand Prix		1987-1978	Eagle	Talon	1998-1990
Grand Safari		1974-1972	Fiat	124	1981-1967
Grandville		1974-1972		128	1979-1971
GTO		1973-1972		131	1978-1975
Laurentian		1981-1976		Brava	1981-1979
LeMans		1974-1970		Strada	1982-1979
LeMans		1981-1976		X-1/9	1983-1974
Parisienne		1986-1976	Honda	600	1972-1969
Phoenix		1979-1977		Civic	1979-1973
Sunbird		1979-1978	Hyundai	Pony	1987-1983
Tempest		1970		Stellar	1987-1985



6637 (Cont'd)	BPR6EIX	Iridium IX	6637 (Cont'd)	BPR6EIX	Iridium IX	
Qty per Vehicle: 2-12		Box Qty: 4	Qty per Vehicle: 2-12		Box Qty: 4	
Jaguar	XJ12	1979-1973	Nissan	200SX	1983-1980	
	XJS	1976		240Z	1973-1970	
	XJS	1979		260Z	1975-1974	
	XKE	1974-1971		510	1981-1980	
Jensen	Healey	1976-1972		610	1976-1974	
Lada	1300	1983		620	1979-1975	
	Niva	1993-1984		710	1976-1974	
	Samara	1993-1988		720	1986-1980	
	Signet	1993-1984		B210	1974	
Lancia	Beta	1979-1976		D21	1989-1986	
	Beta	1981		Pathfinder	1988-1987	
	Zagato	1979		Van	1988-1987	
	Zagato	1982-1981	Peugeot	404	1970-1961	
Land Rover	Discovery	504		1979-1970		
Lotus	Eclat	1979-1976		505	1987-1980	
	Elite	1966-1958		505	1991-1990	
	Esprit	1979-1976	Plymouth	Arrow	1977-1976	
	Esprit	1995-1982		Colt	1980	
	Seven	1975-1962		Cricket	1973-1971	
	Super Seven	1968-1962		Laser	1994-1990	
Maserati	Bora	1983-1971	Porsche	911	1973-1972	
	Ghibli	1973-1967		911	1989-1984	
	Indy	1974-1969		911	1992-1991	
	Khamsin	1979-1974		912	1976	
	Merak	1982-1972		924	1988-1987	
	Mexico	1971-1967		928	1991-1983	
	Quattroporte	1969-1968		928	1995-1993	
	Quattroporte	1986-1979		944	1991-1985	
Mazda	616	1971-1970		Renault	968	1995-1992
	618	1972			Alliance	1987-1985
	626	1987-1986	Encore		1986-1985	
	808	1977-1972	Fuego		1983-1982	
	1800	1971-1970	R5		1986	
	B1600	1976-1972	R12		1977-1975	
	B1800	1978-1977	R15		1976-1975	
	GLC	1978-1977	R17		1979-1975	
	Mizer	1977-1976	R18		1981	
Mercedes-Benz	200	1967-1966	R18i		1983-1981	
	220	1973-1968	Rover	3500	1980	
	230	1969-1966	Saab	95	1973-1968	
	230S	1967-1966		96	1973-1967	
	230SL	1966-1963		99	1980-1969	
	250	1972-1968		900	1984-1979	
	250C	1972-1970		900	1986	
	250S	1967-1966		Monte Carlo	1967	
	250SE	1967-1966		Sonett	1974-1968	
	250SL	1967		Subaru	Brat	1980-1978
	280	1974-1973			Deluxe	1973-1972
	280C	1974-1973			DL	1979-1974
	280S	1971-1968	FE		1979	
	280SE	1973-1968	GF		1979-1975	
	280SEL	1973-1968	GL		1975-1972	
	280SL	1971-1968	GL		1980-1979	
	300SEL	1973-1968	GLF		1980	
	350SL	1972	Star	1972-1971		
	600	1972-1967	Suzuki	Forsa	1988-1985	
	MG	MGB		1981-1962	SA310	1985
MGC		1969-1968	Toyota	2000GT	1970-1967	
Midget		1974-1967		Celica	1974-1971	
Mitsubishi	Eclipse	1999-1990		Corona	1971-1967	
	Galant	1992-1991		Crown	1966-1964	
	Mirage	1989		Land Cruiser	1966-1965	
Morgan	4/4	1981-1980		Pickup	1970-1969	
	Plus 8	1996-1976		Stout	1968-1966	
Morris	Minor	1971-1970		Triumph	TR6	1976-1969





6637 (Cont'd)	BPR6EIX	Iridium IX
Qty per Vehicle: 2-12		Box Qty: 4
Triumph	TR250	1968
Volkswagen	411	1972-1971
	412	1974-1973
	Cabriolet	1993-1985
	Corrado	1992-1990
	Dasher	1980-1975
	Golf	1986-1985
	Golf	1992-1988
	Jetta	1984-1980
	Passat	1991
	Passat	1993
	Quantum	1987-1982
	Rabbit	1984-1980
	Rabbit Convertible	1984-1980
	Rabbit Pickup	1983-1980
	Scirocco	1983-1980
Volvo	240	1993-1990
	242	1984-1976
	244	1989-1976
	245	1989-1976
	264	1981-1980
	740	1992-1985
	745	1985
	760	1987
	780	1991-1989
	940	1995-1991
6644	PTR5D-13	Laser Platinum
Qty per Vehicle: 12		Box Qty: 4
Aston Martin	DB7	2003-2002
6664	BR7EIX	Iridium IX
Qty per Vehicle: 4-6		Box Qty: 4
Honda	Accord	1979
	Prelude	1980-1979
MG	MGA	1959
Porsche	911	1967-1965
	911	1973
6681	DR8EIX	Iridium IX
Qty per Vehicle: 4-12		Box Qty: 4
Chrysler	TC Maserati	1990-1989
Ferrari	328 GTB	1989-1985
	328 GTS	1989-1985
	330 GT	1968
	330 GTC	1968
	330 GTS	1968
	348 GTB	1994-1993
	348 GTS	1994-1993
	348 Spider	1995-1993
	348 TB	1992-1990
	348 TS	1992-1989
	Mondial 3.2	1988-1986
	Mondial 8	1985-1980
	Mondial t	1993-1989
Testarossa	1991-1985	
Lamborghini	Diablo	2000-1997
6684	BPR8EIX	Iridium IX
Qty per Vehicle: 6-12		Box Qty: 4
Ferrari	275 GT	1968
	275 GTB	1968-1964
	512 BB	1981-1977
	Dino 206 GT	1969-1968
	Dino 246 GT	1973-1969
	Dino 246 GTS	1973-1972
Maserati	430i	1990-1989
	Biturbo	1987-1983

6684 (Cont'd)	BPR8EIX	Iridium IX
Qty per Vehicle: 6-12		Box Qty: 4
Porsche	911	1977-1970
	911	1989-1981
	930	1979-1978
6696	BCPR5ES-11	Standard
Qty per Vehicle: 4-6		Box Qty: 4
Acura	Integra	1991-1990
Chevrolet	Nova	1988
Ford	Escort	1981
	EXP	1982
Honda	CRX	1991-1988
	Prelude	1990-1988
Mercedes-Benz	SLK230	2000-1998
Mercury	LN7	1982
	Lynx	1981
Nissan	200SX	1988-1984
	D21	1989-1986
	Multi	1988-1986
	Pathfinder	1989-1987
	Pulsar NX	1990-1989
	Sentra	1990-1989
	Stanza	1989-1984
	Toyota	Camry
Toyota	Celica	1989-1986
	Corolla	1989-1985
	Cressida	1992-1989
	MR2	1989-1985
	Supra	1992-1986
6700	RE7C-L	Laser Iridium
Qty per Vehicle: 2		Box Qty: 4
Mazda	RX-8	2011-2004
6701	RE9B-T	Laser Iridium
Qty per Vehicle: 2		Box Qty: 4
Mazda	RX-8	2011-2004
6735	BUR5EB-11	Standard
Qty per Vehicle: 4		Box Qty: 4
Honda	Accord	1985-1984
	Civic	1987-1984
6737	PZFR5Q-11	Laser Platinum
Qty per Vehicle: 5		Box Qty: 4
Volkswagen	Beetle	2008-2006
	Jetta	2007-2005
	Rabbit	2009-2006
6741	IFR6E11	Laser Iridium
Qty per Vehicle: 4-12		Box Qty: 4
Acura	Integra	2001-1992
	Legend	1995-1991
	NSX	2005-1991
Aston Martin	DB9	2005
Audi	A6 Quattro	2006-2005
Chevrolet	Aveo	2008-2004
	Aveo5	2008-2006
	Epica	2006-2004
	Metro	2001-1998
	Tracker	1991-1990
	Tracker	2002-1998
Chrysler	Sebring	1999-1995
	Sebring	2005-2001
Daewoo	Nubira	2002-1999
Daihatsu	Charade	1992-1989
	Rocky	1992-1990
Dodge	Avenger	1999-1995
	Colt	1994-1993
	Stealth	1996-1991



6741 (Cont'd)		IFR6E11	Laser Iridium	6741 (Cont'd)		IFR6E11	Laser Iridium
Qty per Vehicle: 4-12			Box Qty: 4	Qty per Vehicle: 4-12			Box Qty: 4
Dodge	Stratus		2005-2001	Toyota	Sienna		2000-1998
Eagle	Talon		1998-1995		Solara		2001-1999
Ford	Escort		1996-1991	<b>6744 TR45-1IX</b>		<b>Iridium IX</b>	
	Probe		1997-1993	Qty per Vehicle: 6			Box Qty: 4
Geo	Storm		1991-1990	Ford	Freestar		2007-2006
GMC	Tracker		1991-1989	<b>6745 BKR5EY-11</b>		<b>V-Power</b>	
Honda	Civic		2000-1999	Qty per Vehicle: 4-6			Box Qty: 4
	Civic del Sol		1997-1994	Chevrolet	Tracker		2002-2001
	Passport		1996-1994	Isuzu	Amigo		2000-1998
Infiniti	G20		1996-1991		Axiom		2003-2002
	M30		1992-1990		Rodeo		2002-1996
Isuzu	I-Mark		1989		Rodeo Sport		2002-2001
	Impulse		1992-1990		Trooper		2002-1996
	Rodeo		1995-1993		VehiCROSS		2001-1999
	Rodeo		2003	<b>6757 BPR6EKN</b>		<b>Standard</b>	
	Rodeo Sport		2003	Qty per Vehicle: 4			Box Qty: 4
	Stylus		1992-1991	Eagle	Talon		1998-1995
	Trooper		1995-1992	Lotus	Esprit		1995-1990
Jaguar	XJR		2002-1998	Mitsubishi	Eclipse		1999-1995
Kia	Rio		2005-2003	<b>6774 IZFR6K13</b>		<b>Laser Iridium</b>	
	Sportage		2002-1995	Qty per Vehicle: 4-6			Box Qty: 4
Land Rover	Discovery		2004-1999	Honda	Accord		2007-2003
	Freelander		2005-2002		Fit		2014-2007
Lexus	ES300		1998-1996	<b>6779 BCPR6ES-11</b>		<b>Standard</b>	
Lotus	Elise		2007-2005	Qty per Vehicle: 4-6			Box Qty: 4
	Exige		2006	Acura	Integra		1989-1986
Mazda	Protege		1994-1990		Legend		1990-1986
Mercury	Capri		1994-1991	Honda	Civic		1991-1988
	Tracer		1996-1991		CRX		1991-1988
Mini	Cooper		2008-2007		Prelude		1990-1988
Mitsubishi	3000GT		1999-1991	Lexus	ES250		1991-1990
	Diamante		1995-1992		ES300		1993-1992
	Eclipse		2000-1999	Mazda	323		1989-1988
	Galant		2000-1999	Nissan	200SX		1988-1984
	Montero		1996-1995		300ZX		1989-1984
	Montero Sport		1998-1997		Maxima		1988-1985
Nissan	200SX		1998-1995		Multi		1988-1986
	Frontier		2004-2001		Pulsar NX		1989-1987
	Maxima		1994-1989		Stanza		1989-1984
	NX		1993-1991	Peugeot	405		1991-1989
	Sentra		1994-1991	Saab	9-5		2005-1999
	Sentra		1999-1998		9000		1994-1991
	Xterra		2004-2002	Sterling	825		1988-1987
Plymouth	Colt		1994-1993		827		1991-1989
Pontiac	Wave		2008-2005	Toyota	Camry		1993-1988
	Wave5		2007-2005		MR2		1989-1988
Porsche	911		2002-2001	<b>6832 BUR7EB-11</b>		<b>Standard</b>	
	911		2005	Qty per Vehicle: 4			Box Qty: 4
	Boxster		2004-2001	Honda	Accord		1980
	Carrera GT		2005-2004		Civic		1980
Subaru	Baja		2003		Prelude		1980
	Forester		2004-1999	<b>6858 DFH6B-11A</b>		<b>Laser Iridium</b>	
	Impreza		2004-1993	Qty per Vehicle: 6-8			Box Qty: 4
	Legacy		2003-1990	Lexus	GS300		2006
	Outback		2003-2000		GS350		2011-2007
	SVX		1997-1992		GS350		2015-2013
Suzuki	Esteem		2001-1999		GS450h		2011-2007
	Grand Vitara		1999		GS460		2011-2008
	Swift		2001-1995		IS250		2015-2006
	Swift+		2008-2004		IS300		2017-2016
	Verona		2006-2005		IS350		2017-2006
	Vitara		2002-1999		IS F		2014-2008
Toyota	Avalon		1999-1996		LS460		2017-2007
	Camry		2001-1996				
	RAV4		2000-1997				



6858 (Cont'd)	DFH6B-11A	Laser Iridium
Qty per Vehicle: 6-8		Box Qty: 4
Lexus	LS600h	2016-2008
	RC300	2017-2016
	RC350	2017-2015
6917	BUR7EQ	Standard
Qty per Vehicle: 2		Box Qty: 4
Mazda	RX-7	1991-1986
	RX-7	1995-1993
6931	BR6EB-L-11	Standard
Qty per Vehicle: 4		Box Qty: 4
Honda	Accord	1983-1981
	Prelude	1982-1981
6937	BPR5EY-11	V-Power
Qty per Vehicle: 3-6		Box Qty: 4
Chevrolet	Nova	1988-1985
	Sprint	1992-1989
Chrysler	Daytona	1993-1990
	Dynasty	1990-1988
	E Class	1984-1983
	Executive Limousine	1985
	Executive Sedan	1984-1983
	Grand Voyager	2000
	LeBaron	1985-1982
	LeBaron	1995-1990
	New Yorker	1985-1983
	New Yorker	1989-1988
	TC Maserati	1991-1990
	Town & Country	1982
	Town & Country	1985-1984
Voyager	2000	
Daihatsu	Charade	1992-1988
Dodge	400	1983-1982
	600	1985-1983
	Aries	1985-1981
	Caravan	2000-1984
	Challenger	1983-1978
	Colt	1980-1978
	Colt	1995-1991
	D50	1982-1979
	Daytona	1993-1990
	Dynasty	1993-1988
	Grand Caravan	1989-1987
	Grand Caravan	2000-1992
	Mini Ram	1988-1987
	Power Ram 50	1983
	Raider	1989
	Ram 50	1983
	Ram 50	1991-1990
	Shadow	1994-1992
	Spirit	1995-1989
	Stealth	1996-1991
Eagle	Summit	1996-1989
	Vista	1992-1988
Honda	Accord	1989-1986
	Civic	1973
	Passport	1996-1994
	Prelude	1987-1985
Hyundai	Santa Fe	2006-2001
	Sonata	2005-1990
Isuzu	Amigo	1994-1989
	Pickup	1995-1992
	Rodeo	1997-1991
	Trooper	1991-1988
Kia	Magentis	2006-2001
	Optima	2006-2001

6937 (Cont'd)	BPR5EY-11	V-Power	
Qty per Vehicle: 3-6		Box Qty: 4	
Kia	Sephia	1995-1994	
Mazda	323	1995-1986	
	B2200	1993-1990	
	B2600	1988-1987	
Mitsubishi	3000GT	1999-1997	
	Galant	1988-1985	
	Mighty Max	1985-1983	
	Mighty Max	1994-1990	
	Mirage	1999-1991	
	Montero	1985-1983	
	Montero	1994-1989	
	Sigma	1990-1989	
	Nissan	210	1982-1979
		280Z	1978-1977
280ZX		1980-1979	
310		1982-1979	
810		1979-1977	
B210		1978-1977	
F10		1978-1977	
Micra		1991-1984	
Pulsar		1983	
Pulsar NX		1988-1983	
Sentra		1986-1982	
Stanza		1983-1982	
Plymouth		Acclaim	1995-1989
		Arrow	1980-1979
		Arrow Pickup	1982-1979
		Caravelle	1985-1983
	Colt	1980-1978	
	Colt	1992-1991	
	Grand Voyager	1989-1987	
	Grand Voyager	2000-1992	
	Reliant	1985-1981	
	Sapporo	1983-1978	
	Sundance	1994-1992	
	Voyager	2000-1984	
	Toyota	Camry	1986-1983
		Celica	1986-1982
		Corolla	1988-1980
		Cressida	1988-1982
Land Cruiser		1978-1975	
Land Cruiser		1992-1990	
Starlet		1984-1983	
Tercel		1994-1981	
Van		1989-1984	
6945		UR45	V-Power
Qty per Vehicle: 4-8		Box Qty: 4	
American Motors		Concord	1982-1980
		Eagle	1983-1981
	Spirit	1982-1980	
Buick	Apollo	1975	
	Century	1985-1975	
	Electra	1975	
	Electra	1985-1977	
	Estate Wagon	1975	
	Estate Wagon	1980-1978	
	LeSabre	1985-1975	
	Regal	1987-1975	
	Riviera	1975	
	Riviera	1978-1977	
	Riviera	1984-1981	
	Skyhawk	1980-1977	
	Skylark	1982-1975	
Cadillac	DeVille	1982-1980	
	Eldorado	1982-1981	



6945 (Cont'd)		UR45	V-Power	6945 (Cont'd)		UR45	V-Power
Qty per Vehicle: 4-8			Box Qty: 4	Qty per Vehicle: 4-8			Box Qty: 4
Cadillac	Fleetwood		1982-1980	Mercury	Montego		1974
	Seville		1982-1981		Monterey		1974
Checker	Marathon		1975		Zephyr		1982-1978
	Marathon		1977	Oldsmobile	98		1975
Chevrolet	Marathon		1982-1979		98		1983-1981
	Brookwood		1971		98		1985
	Camaro		1983-1980		Custom Cruiser		1975
	Caprice		1985-1980		Cutlass		1981-1977
	Celebrity		1983-1982		Cutlass Calais		1984-1978
	Citation		1983-1980		Cutlass Ciera		1985-1982
	El Camino		1984-1978		Cutlass Cruiser		1983-1980
	Impala		1985-1980		Cutlass Salon		1980-1978
	Malibu		1983-1978		Cutlass Salon		1987-1985
	Monte Carlo		1987-1978		Cutlass Supreme		1987-1977
	Monza		1975		Delta 88		1975
Monza		1980-1978	Delta 88			1985-1977	
Nova		1970	Omega			1975	
Omega		1983-1977	Omega			1983-1977	
Starfire		1980-1977	Starfire		1980-1977		
Toronto		1984-1981	Toronto		1984-1981		
Excalibur	Phaeton		1989-1971	Pontiac	6000		1983-1982
Ford	Bronco		1996-1989		Astre		1977
	Custom 500		1977		Bonneville		1986-1975
	E-150 Econoline		1996-1989		Catalina		1981-1975
	E-150 Econoline Club Wagon		1996-1986		Firebird		1983-1975
	E-250 Econoline		1991-1989		Grand Am		1975
	F-150		1996-1989		Grand Am		1980-1978
	F-250		1996-1989		Grand LeMans		1983-1975
	Fairmont		1982-1978		Grand Prix		1987-1975
	Granada		1981-1977		Grand Safari		1978-1975
	LTD		1985-1977		Grandville		1975
	LTD II		1979-1977		Laurentian		1977-1976
	Maverick		1977		Laurentian		1981-1980
	Mustang		1982-1979		LeMans		1981-1975
	Mustang		1985-1984		Parisienne		1977-1976
	Mustang		1995-1987	Parisienne		1985-1980	
	Mustang II		1978-1977	Phoenix		1983-1977	
	P-400		1976	Sunbird		1980-1977	
P-500		1977-1976	Ventura		1977-1975		
Ranchero		1979-1975					
Thunderbird		1974					
Thunderbird		1982-1977					
Thunderbird		1985-1984					
Thunderbird		1993-1991					
GMC	Caballero		1984-1978	<b>6953</b>		<b>BKR5E-11</b>	<b>V-Power</b>
Jeep	CJ5		1983-1980	Qty per Vehicle: 4-16			Box Qty: 4
	CJ7		1983-1980	Acura	RL		2004-2003
	Scrambler		1983-1981	Chevrolet	Corvette		1992-1990
Lincoln	Continental		1974		Prizm		2002-1998
	Continental		1980-1977		Tracker		2004-2001
	Continental		1985-1982	Chrysler	Cirrus		2000-1995
	Mark IV		1974		Crossfire		2008-2004
	Mark V		1979-1977		Sebring		2005-1995
	Mark VI		1983-1980	Dodge	Avenger		2000-1995
	Mark VII		1985-1984		Colt		1994-1993
	Mark VII		1992-1987		Stratus		2000-1995
	Town Car		1985-1981	Eagle	Summit		1996-1992
	Versailles		1980-1977	Ford	Thunderbird		2005-2002
	Mercury	Capri		1983-1979	Geo	Storm	
Colony Park			1974	Honda	Civic		2005-2003
Comet			1977	Hyundai	Accent		2011-1995
Cougar			1974		Azera		2011-2006
Cougar			1985-1977		Elantra		2007-1996
Cougar			1993-1991		Entourage		2010-2007
Grand Marquis			1985-1977		Santa Fe		2009-2001
Marquis			1974		Scoupe		1995-1993
Marquis			1982-1977		Sonata		2010-1999
Monarch			1980-1977		Tiburon		2001-1997
					Tiburon		2008-2003
			Tucson			2009-2005	



6953 (Cont'd)		BKR5E-11	V-Power	6953 (Cont'd)		BKR5E-11	V-Power	
Qty per Vehicle: 4-16			Box Qty: 4	Qty per Vehicle: 4-16			Box Qty: 4	
Hyundai	Veracruz		2012-2007	Mercedes-Benz	S500		2006-2000	
	XG300		2001		SL500		2000-1999	
	XG350		2005-2002		SL500		2006-2003	
			SLK320			2004-2003		
Infiniti	G20		2002-1999	Mercury	Villager		2002-1999	
	I30		2001-1996		Mitsubishi	Diamante		2004-1997
	J30		1997-1993	Eclipse			2005-1996	
	Q45		2001-1990	Expo			1995-1993	
	QX4		2000-1997	Expo LRV			1994-1992	
			Galant			2003-1992		
Isuzu	Rodeo		2004-2003	Lancer		2007-2002		
	Rodeo Sport		2003	Mirage		2002-1993		
Jaguar	S-Type		2007-2000	Montero		2002-1994		
	Super V8		2005	Montero Sport		2004-1997		
	Vanden Plas		1999-1997	Outlander		2003		
	Vanden Plas		2005-2003	Nissan	240SX		1998-1991	
	XJ8		1999-1998		300ZX		1996-1990	
	XJ8		2007-2003		Altima		2001-1993	
	XJR		2006-2004		Frontier		2004-1998	
	XK8		1999-1997		Maxima		2001-1992	
	XK8		2006-2003		NX		1993-1991	
	XKR		2006-2004		Pathfinder		2000-1996	
					Quest		2002-1999	
			Sentra			2001-1991		
			Xterra			2004-2000		
			Plymouth	Colt		1994-1993		
Kia	Amanti		2006-2004	Pontiac	Vibe		2008-2003	
	Magentis		2006-2001	Saab	9-2X		2006	
	Optima		2006-2001	Saturn	SC		1992-1991	
	Rio		2011-2006		SC2		2002-1993	
	Rio5		2011-2006		SL2		2002-1991	
	Rondo		2008-2007	SW2		2001-1993		
	Sedona		2012-2002	Scion	xB		2013-2012	
	Sedona		2014		Subaru	Baja		2006-2004
	Sephia		1997-1995	Forester			1998	
	Sorento		2009-2003	Forester			2010-2005	
	Spectra		2007-2004	Impreza			1998	
	Spectra5		2007-2005	Impreza			2011-2005	
	Sportage		2010-2005	Legacy			1999-1996	
			Legacy			2009-2005		
Lincoln	LS		2006-2000	Outback		2009-2004		
				Suzuki	Aerio		2007-2002	
Mazda	2		2014-2011		Grand Vitara		2005-2000	
	323		1991-1990		SX4		2009-2007	
	323		1994-1993		Vitara		2004-2000	
	626		2002-1993		XL-7		2003-2002	
	929		1995-1992		Toyota	4Runner		2002-1996
	Miata		1997-1994			Celica		2003-2000
	Miata		2005-1999	Corolla			2008-1998	
	MPV		1998-1996	Corolla			2012	
	MX-3		1996-1992	Echo			2000	
	MX-6		1997-1993	Matrix			2003	
	Protege		2003-1990	Matrix			2008-2005	
	Protege5		2003-2002	Matrix			2013-2012	
				MR2 Spyder			2005-2000	
				Paseo			1999-1995	
Mercedes-Benz	C240		2005-2003	Prius		2009-2001		
	C280		1998	Supra		1998		
	C320		2005-2003	T100		1998-1995		
	CL500		2006-2003	Tacoma		2004-1995		
	CLK320		2005-2003	Tercel		1999-1995		
	CLK430		2003	Tundra		2004-2000		
	CLK500		2006-2003	Yaris		2009-2006		
	CLS500		2006	Yaris		2014-2011		
	E320		2005-2003	Volkswagen	Beetle		2004	
	E500		2006-2003					
	G55 AMG		2004-2003					
	G500		2008-2003					
	ML55 AMG		2003					
	ML320		2003					
	ML350		2005-2003					
	ML500		2004-2003					
	ML500		2007					
	R500		2007-2006					
	S430		2006-2003					





6962	BKR6E	V-Power	6962 (Cont'd)	BKR6E	V-Power
Qty per Vehicle: 4-12		Box Qty: 4	Qty per Vehicle: 4-12		Box Qty: 4
Alfa Romeo	164	1995-1991	Chevrolet	Tracker	1989
Audi	90 Quattro	1992-1990	Chrysler	Cirrus	2000
	A4	1997-1996		Neon	2002-2000
	A4	2001-1999	Daewoo	Leganza	2002-1999
	A4 Quattro	1996	Dodge	Neon	2005-1995
	A4 Quattro	2001-1998		Stratus	2000-1995
	A6	2001-1998		SX 2.0	2005-2003
	A6 Quattro	1996-1995	Geo	Prizm	1992-1990
	A6 Quattro	2004-1998		Tracker	1997-1994
	A8 Quattro	2006-1997	Hyundai	Scoupe	1995-1993
	Allroad Quattro	2005-2003	Isuzu	Impulse	1992-1991
	Cabriolet	1996-1995	Jaguar	Vanden Plas	1996-1988
	Coupe Quattro	1991-1990		XJ6	1997-1987
	S4	2009-2004		XJR	1996-1995
	S6	2003-2002		XJS	1996-1992
	Bentley	Arnage	2003-2001	Kia	Rio
1999			Sephia		2001-1998
BMW	318i	1999-1991	Spectra		2004-2000
	318is	1999-1991	Land Rover	Range Rover	2005-2003
	318ti	1999-1995		Elan	1990
	320i	1995-1992	Elan	1992	
	320i	2005-2001	Esprit	2003-1997	
	323Ci	2000	Mini	Cooper	2006-2002
	323i	2000-1998	Mitsubishi	Eclipse	1998-1995
	323is	1999-1998		Eclipse	2005-2003
	325Ci	2006-2001		Endeavor	2008-2004
	325i	1995-1992		Endeavor	2011-2010
	325i	2005-2001		Galant	2007-2004
	325is	1995-1992		Galant	2009
	325xi	2005-2001		Lancer	2010-2008
	328Ci	2000	Montero	2006-2003	
	328i	2000-1996	Morgan	Aero 8	2005-2004
	328is	1999-1996	Plymouth	Breeze	2000-1996
	330Ci	2006-2001		Neon	2001-1995
	330i	2005-2001	Pontiac	Sunrunner	1997-1995
	330xi	2005-2001	Porsche	911	1994-1990
	525i	1995-1991		911	1997-1996
	525i	2005-2001		911	2005-1999
	525iT	1993		911	2009-2007
	528i	2000-1997		Boxster	2004-1997
	530i	1995-1994		Carrera GT	2005-2004
	530i	2005-2001	Cayenne	2006-2003	
	540i	1995-1994	Rolls-Royce	Park Ward	2002
	540i	2003-1997		Phantom	2013-2004
	545i	2005-2004		Silver Seraph	2002-1999
	645Ci	2005-2004	Saab	9-2X	2005
	740i	1995-1993		900	1997-1994
	740i	2001-1997		9000	1997-1995
	740iL	2001-1993	Saturn	Ion	2007-2004
	745i	2005-2002	Subaru	Impreza	2005-2002
	745Li	2005-2002		Suzuki	Esteem
	750iL	2001-1998	Forenza		2008-2004
	760i	2006-2004	Reno		2008-2005
	760Li	2008-2003	Sidekick		1998-1993
	840Ci	1997-1994	Swift		1993-1992
	M3	1999-1994	Verona		2004
	M5	2003-2000	X-90		1998-1996
	X3	2006-2004	Toyota		Celica
	X5	2006-2000		Corolla	1992-1990
	Z3	2002-1996		MR2	1995-1991
	Z4	2005-2003	Volkswagen	Beetle	2001
	Z8	2003-2000		Beetle	2003
Cadillac	CTS	2004-2003		Golf	1986
		2007-2005		Golf	1993-1990
Chevrolet	Cobalt	2007-2005		Golf	2001-2000
		2007-2004			



6962 (Cont'd)		BKR6E	V-Power
Qty per Vehicle: 4-12			Box Qty: 4
Volkswagen	Jetta		1992-1990
	Jetta		2001
	Passat		1991-1990
	Passat		2005-1998
	Phaeton		2006-2004
	Touareg		2007-2004
Volvo	850		1997-1993
	960		1997-1992
	C70		2004-1998
	S40		2004-2000
	S60		2009-2001
	S70		2000-1998
	S80		2010-1999
	S90		1998-1997
	V40		2004-2000
	V70		2007-1998
	V90		1998-1997
	XC70		2007-2003
	XC90		2011-2003
6987		ZFR6F-11G	V-Power
Qty per Vehicle: 4-10			Box Qty: 4
Acura	EL		2003-2001
Chrysler	Aspen		2007
Dodge	Dakota		2010-2004
	Durango		2009-2000
	Nitro		2011-2007
	Ram 1500		2010-2002
	Ram 2500		2003-1997
	Ram 3500		2003-1997
Jeep	Commander		2010-2006
	Grand Cherokee		2010-1999
	Liberty		2012-2002
Mitsubishi	Raider		2009-2006
Ram	1500		2013-2011
	Dakota		2011
6988		BKR7EIX-11	Iridium IX
Qty per Vehicle: 4-6			Box Qty: 4
Acura	CSX		2010-2007
	Integra		2001
	RSX		2006-2002
Honda	Civic		2011-2006
	S2000		2009-2000
Saab	9-5		2003-1999
6992		BKUR6ETB	Standard
Qty per Vehicle: 4-6			Box Qty: 4
Chevrolet	Optra		2004
Suzuki	Verona		2004
6994		IZFR6K11	Laser Iridium
Qty per Vehicle: 4-6			Box Qty: 4
Acura	CSX		2011-2006
	MDX		2009-2007
	RL		2008-2005
	RSX		2006-2002
	TL		2008-2004
	TSX		2008-2004
Honda	Accord		2007-2003
	Civic		2005-2002
	CR-V		2009-2002
	Element		2011-2003
7022		BPR6HS	Standard
Qty per Vehicle: 4-8			Box Qty: 10
Buick	Skylark		1962-1961
Citroen	D21		1972-1968

7022 (Cont'd)		BPR6HS	Standard
Qty per Vehicle: 4-8			Box Qty: 10
Citroen	DS21		1972-1968
	DS21 Pallas		1972-1968
	D Special		1972-1970
	ID19		1970-1968
Mercedes-Benz	190B		1962-1960
	190C		1965-1963
	190SL		1963-1960
	220		1965-1960
	220S		1965-1960
	220SE		1966-1960
Oldsmobile	Cutlass		1963-1962
	Jetfire		1962
Opel	1900		1975-1971
	Deluxe		1971
	Kadett		1972-1967
	Manta		1975-1971
	Opel		1973-1969
	Rallye		1970-1968
Porsche	356A		1959-1955
	356B		1963-1960
	356C		1965-1964
	356SC		1965-1964
	Carrera		1959-1958
Renault	LeCar		1978-1977
	R5		1976
	R8		1966-1963
	R10		1969-1967
Saab	95		1968
	96		1968-1967
	Monte Carlo		1967
Triumph	Spitfire		1967-1963
	TR3A		1961-1960
	TR3B		1962
	TR4		1964-1962
	TR4A		1967-1965
Volvo	122		1966-1959
	142		1974-1969
	144		1974-1969
	145		1974-1969
	164		1975-1970
	242		1975
	244		1975
	245		1975
	445		1960-1959
	544		1965-1959
	1800		1965-1961
	1800		1968
1800		1973	
7037		BUR6EB-11	Standard
Qty per Vehicle: 4			Box Qty: 4
Honda	Civic		1983-1980
	Prelude		1983
	Wagovan		1984
	Wagovan		1987-1986
7052		YR5	V-Power
Qty per Vehicle: 6-8			Box Qty: 4
Buick	Apollo		1974-1973
Chevrolet	Bel Air		1970
	Bel Air		1974-1972
	Biscayne		1970
	Biscayne		1972
	Blazer		1974-1970
	Brookwood		1972
	C10		1980-1975



7052 (Cont'd)		YR5	V-Power	7052 (Cont'd)		YR5	V-Power
Qty per Vehicle: 6-8			Box Qty: 4	Qty per Vehicle: 6-8			Box Qty: 4
Chevrolet	C10		1983-1982	GMC	C25		1978-1975
	C10		1986-1985		C25/C2500 Pickup		1974-1970
	C10 Pickup		1974-1970		C25/C2500 Suburban		1974-1970
	C10 Suburban		1981-1970		C25 Suburban		1978-1975
	C10 Suburban		1986-1985		C35		1978-1975
	C20		1986-1975		C35/C3500 Pickup		1974-1970
	C20 Pickup		1974-1970		C1500		1983-1979
	C20 Suburban		1986-1970		C1500		1986-1985
	C30		1986-1975		C1500 Suburban		1983-1979
	C30 Pickup		1974-1970		C1500 Suburban		1986-1985
	C50		1990-1986		C2500		1986-1979
	C70		1990-1986		C2500 Suburban		1986-1979
	Camaro		1970		C3500		1986-1979
	Camaro		1974-1972		Caballero		1979-1978
	Caprice		1970		G15		1978-1975
	Caprice		1974-1972		G15/G1500 Van		1974-1970
	Chevelle		1973-1970		G25		1978-1975
	Corvette		1970		G25/G2500 Van		1974-1970
	Corvette		1974-1972		G35		1978-1975
	El Camino		1974-1969		G35/G3500 Van		1974-1971
	El Camino		1979-1976		G1500		1983-1979
	G10		1983-1975		G2500		1983-1979
	G10 Van		1970		G2500		1986-1985
	G10 Van		1974-1972		G3500		1988-1979
	G20		1986-1975		Jimmy		1981-1970
	G20 Van		1974-1970		K15		1978-1975
	G30		1988-1975		K15/K1500 Pickup		1974-1970
	G30 Van		1974-1971		K15/K1500 Suburban		1974-1970
	Impala		1970		K15 Suburban		1978-1975
	Impala		1974-1972		K25		1978-1975
	K5 Blazer		1981-1975		K25/K2500 Pickup		1974-1970
	K10		1986-1975		K25/K2500 Suburban		1974-1970
	K10 Pickup		1974-1970		K25 Suburban		1978-1975
	K10 Suburban		1983-1970		K35		1978-1977
	K10 Suburban		1986-1985		K35/K3500 Pickup		1974-1970
	K20		1986-1975		K1500		1985-1979
	K20 Pickup		1974-1970		K1500 Suburban		1984-1979
	K20 Suburban		1986-1970		K2500		1986-1979
	K30		1986-1977		K2500 Suburban		1986-1979
	K30 Pickup		1974-1970		K3500		1986-1979
	Kingswood		1972		P15		1978-1975
	Laguna		1975-1973		P15/P1500 Van		1970
	Malibu		1974-1973		P15/P1500 Van		1974-1972
	Monte Carlo		1974-1970		P25		1978-1975
	Nova		1970		P25/P2500 Van		1974-1970
	Nova		1974-1972		P35		1978-1975
	P10		1980-1975		P35/P3500 Van		1974-1970
	P10 Van		1970		P1500		1980-1979
	P10 Van		1974-1972		P2500		1987-1979
	P20		1989-1975		P2500		1989
P20 Van		1974-1970	P3500		1989-1979		
P30		1989-1975	R2500		1988-1987		
P30 Van		1974-1970	R3500		1989-1987		
R20		1988-1987	Sprint		1977-1972		
R30		1988-1987	V2500		1987		
R3500		1989	V3500		1989-1987		
Townsmen		1970	Pontiac	Ventura	1972		
Townsmen		1972	<b>7060</b>	<b>TR5-1</b>	<b>V-Power</b>		
V20		1987	Qty per Vehicle: 4-6			Box Qty: 4	
V30		1988-1987	Buick	Century	1996		
V3500		1989	Ford	Aerostar	1987-1986		
GMC	C15			E-150	2003		
	C15/C1500 Pickup			E-150 Club Wagon	2003		
	C15/C1500 Suburban			E-250	2003		
	C15 Suburban			Escort	1990-1983		



7060 (Cont'd)		TR5-1	V-Power	7082 (Cont'd)		BPR5EGP	G-Power
Qty per Vehicle: 4-6			Box Qty: 4	Qty per Vehicle: 3-12			Box Qty: 4
Ford	EXP		1988-1983	Chrysler	Town & Country		1982
	F-150		2003		Town & Country		1985-1984
	F-150		2007-2005		Voyager		2000
	F-150 Heritage		2004	Citroen	SM		1975-1973
	Fairmont		1983	Daihatsu	Charade		1992-1988
	LTD		1986-1983	Dodge	400		1983-1982
	Mustang		1990-1983		600		1985-1983
	Ranger		1988-1983		Aries		1985-1981
	Thunderbird		1984		Caravan		2000-1984
Mercury	Capri		1986-1983		Challenger		1983-1978
	Cougar		1984-1983		Colt		1975-1974
	LN7		1983		Colt		1980-1978
	Lynx		1987-1982		Colt		1995-1991
	Marquis		1986-1983		D50		1982-1979
	Zephyr		1983		Daytona		1993-1990
<b>7067</b>	<b>BR7HIX</b>		<b>Iridium IX</b>	Dynasty		1993-1988	
Qty per Vehicle: 2			Box Qty: 4	Grand Caravan		1989-1987	
Subaru	360		1970-1968	Grand Caravan		2000-1992	
<b>7082</b>	<b>BPR5EGP</b>		<b>G-Power</b>	Mini Ram		1988-1987	
Qty per Vehicle: 3-12			Box Qty: 4	Power Ram 50		1983	
Aston Martin	Lagonda		1989-1979	Raider		1989	
	V-8		1989-1979	Ram 50		1983	
	Virage		1989	Ram 50		1991-1990	
	Zagato		1988-1987	Shadow		1994-1992	
Asuna	Sunrunner		1992	Spirit		1995-1989	
Audi	4000		1980	Stealth		1996-1991	
	Fox		1979-1973	Eagle	Summit		1996-1989
BMW	2.8 Bavaria		1971	Vista		1992-1988	
	3.0CS		1974-1971	Geo	Tracker		1995-1989
	3.0CSi		1974-1971	Honda	Accord		1989-1986
	3.0CSL		1971		Civic		1973
	3.0S		1974-1971		Passport		1996-1994
	3.0Si		1971	Prelude		1987-1985	
	3.0Si		1976-1975	Hyundai	Santa Fe		2006-2001
	318i		1985-1984		Sonata		2005-1990
	320i		1983-1977	Isuzu	Amigo		1994-1989
	528i		1981-1979		Pickup		1995-1992
	530i		1978-1975		Rodeo		1997-1991
	533i		1984-1983	Trooper		1991-1988	
	535i		1988-1985	Jaguar	3.8		1966-1960
	535is		1988		420		1967
	630CSi		1978-1977		Mark X		1966-1962
	633CSi		1984-1978		Vanden Plas		1987-1982
	635CSi		1987-1985		XJ		1971-1969
	733i		1984-1978		XJ6		1987-1972
	735i		1987-1985		XJS		1978
	2500		1971-1968		XK150		1961-1958
2800		1974-1968	XKE		1971-1961		
Bavaria		1974-1972	Kia	Magentis		2006-2001	
L6		1987		Optima		2006-2001	
Chevrolet	Nova			1988-1985	Sephia		1995-1994
	Sprint		1992-1989	Land Rover	Defender 90		1995-1994
Chrysler	Daytona		1987		Defender 90		1997
	Daytona		1993-1990		Defender 110		1993
	Dynasty		1990-1988		Range Rover		2002-1987
	E Class		1984-1983	Lotus	Elite		1979-1976
	Executive Limousine		1985		Esprit		1982-1980
	Executive Sedan		1984-1983	Mazda	323		1995-1986
	Grand Voyager		2000		626		1987-1979
	LeBaron		1985-1982		B2000		1984-1979
	LeBaron		1995-1990		B2000		1987-1986
	New Yorker		1985-1983		B2200		1993-1987
	New Yorker		1989-1988		B2600		1988-1987
	TC Maserati		1991-1990		GLC		1985-1979
	Mercedes-Benz				230		1978-1974



7082 (Cont'd)		BPR5EGP	G-Power	7082 (Cont'd)		BPR5EGP	G-Power
Qty per Vehicle: 3-12			Box Qty: 4	Qty per Vehicle: 3-12			Box Qty: 4
Mercedes-Benz	280		1976-1975	Porsche	944		1984-1983
	280C		1976-1975	Renault	Alliance		1987-1983
	280CE		1981-1978		Encore		1986-1984
	280E		1981-1977		LeCar		1985-1980
	280S		1976-1975	Rolls-Royce	Corniche		1985-1984
	280SE		1980-1977		Corniche II		1992-1986
	380SE		1985-1984		Silver Spirit		1991-1987
	380SEC		1983-1982		Silver Spur		1991-1987
	380SEL		1983-1981	Suzuki	LJ81		1981
	380SL		1985-1981		Samurai		1995-1985
	380SLC		1981		Sidekick		1994-1989
	420SEL		1991-1986		SJ410		1985-1980
	450SE		1976-1973	SJ413		1985	
	450SEL		1980-1973	Toyota	4Runner		1995-1984
	450SL		1980-1973		Camry		1986-1983
	450SLC		1980-1973		Carina		1973-1972
	500SEC		1985-1984		Celica		1986-1973
	500SEL		1985-1984		Corolla		1988-1968
	560SEC		1991-1986		Corona		1982-1972
	560SEL		1991-1986		Cressida		1988-1978
560SL		1989-1986	Crown			1972-1967	
MG	Midget		1966-1962		Land Cruiser		1992-1967
	Midget		1979-1975		Mark II		1976-1972
Mitsubishi	3000GT		1999-1997		Pickup		1995-1970
	Galant		1988-1985		Starlet		1984-1981
	Mighty Max		1985-1983		Tercel		1994-1981
	Mighty Max		1994-1990		Van		1989-1984
	Mirage		1999-1991	Van Wagon		1988	
	Montero		1985-1983	Triumph	GT6		1973-1967
	Montero		1994-1989		Spitfire		1980-1963
	Sigma		1990-1989		Stag		1973-1971
Nissan	200SX		1983-1982		TR7		1982-1975
	210		1982-1979	TR8		1982-1980	
	280Z		1978-1977	Volkswagen	Dasher		1980-1974
	280ZX		1980-1979		Rabbit		1980-1975
	310		1982-1979		Rabbit Convertible		1980
	720		1986-1981		Rabbit Pickup		1980
	810		1979-1977		Scirocco		1980-1975
	1200		1973-1971	Volvo	760		1986-1984
	2000		1970-1968		760		1990-1988
	B210		1978-1975		DL		1984
	D21		1989-1986		GLE		1984
	F10		1978-1976	Yugo	Cabrio		1992-1990
	Micra		1991-1984		GV		1992-1986
	Pathfinder		1988-1987		GVL		1989-1988
	Pulsar		1983		GVS		1988
	Pulsar NX		1988-1983		GVX		1989-1988
	Sentra		1986-1982	<b>7084</b>		<b>BPR6EGP</b>	<b>G-Power</b>
	Stanza		1983-1982	Qty per Vehicle: 2-12			Box Qty: 4
	Van		1988-1987	Alfa Romeo	2600		1967
	Plymouth	Acclaim			1995-1989	Alfetta	
Arrow			1980-1979		GTV-6		1986-1981
Arrow Pickup			1982-1979		Milano		1989-1987
Caravelle			1985-1983		Montreal		1975-1971
Colt			1980-1978		Sport		1979-1978
Colt			1992-1991		Sprint		1979-1977
Grand Voyager			1989-1987	Aston Martin	DB4		1963-1958
Grand Voyager			2000-1992		DB5		1965-1963
Reliant			1985-1981		DB6		1970-1965
Sapporo			1983-1978		DBS		1971-1967
Sundance			1994-1992		Lagonda		1978-1977
Voyager			2000-1984		V-8		1978-1972
Pontiac		Sunrunner			1994	V-8	
		Porsche	911		1979-1978	Vantage	
928			1982-1978	Audi	100 Series		1971-1969





7084 (Cont'd)	BPR6EGP	G-Power	7084 (Cont'd)	BPR6EGP	G-Power	
Qty per Vehicle: 2-12		Box Qty: 4	Qty per Vehicle: 2-12		Box Qty: 4	
Audi	4000	1983-1980	Hyundai	Excel	1994-1986	
	4000 Quattro	1987-1986		Pony	1987-1983	
	5000	1983-1978		Scoupe	1992-1991	
	5000	1988-1985		Sonata	1998-1989	
	5000 Quattro	1986		Stellar	1987-1985	
	Coupe	1987-1981	Isuzu	Amigo	1989	
	Super 90	1972-1969		I-Mark	1989-1981	
Austin	America	1972-1968		Impulse	1989-1983	
	Marina	1975-1973		Pickup	1991-1981	
	Mini	1966-1960		Stylus	1993-1991	
	Mini 850	1966-1960		Trooper	1987-1984	
	Mini Cooper	1969-1962		Jaguar	XJ12	1979-1973
Austin Healey	3000	1967-1959	XJS		1976	
	Sprite	1970-1962	XJS		1979	
Bertone	X-1/9	1989-1984	XKE		1974-1971	
	BMW	1600	1971-1964	Jensen	Healey	1976-1972
1600-2		1971-1966	Lada	1300	1983	
1600ti		1968-1966		Niva	1993-1984	
1602		1971-1967		Samara	1993-1988	
1800		1971-1968		Signet	1993-1984	
1802		1971	Lancia	Beta	1979-1976	
2000		1972-1966		Beta	1981	
2000c		1969-1968		Zagato	1979	
2000cs		1969-1968		Zagato	1982-1981	
2000ti		1971-1968	Land Rover	Discovery	1999-1994	
2000tii		1972-1969		Lotus	Eclat	1979-1976
2002		1976-1966	Elite		1966-1958	
2002ti		1971-1968	Esprit		1979-1976	
2002tii		1974-1971	Esprit		1995-1982	
2800CS		1971-1968	Seven		1975-1962	
Buick		Opel	1979-1976		Super Seven	1968-1962
		Chevrolet	Metro		1992	Maserati
Metro	2000-1998		Ghibli	1973-1967		
Sprint	1992-1987		Indy	1974-1969		
Chrysler	Conquest	1988-1987	Khamsin	1979-1974		
Citroen	SM	1975-1971	Merak	1982-1972		
Daewoo	Lanos	2002-1999	Mexico	1971-1967		
Dodge	2000 GTX	1990-1989	Quattroporte	1969-1968		
	Challenger	1979-1978	Quattroporte	1986-1979		
	Colt	1991-1971	Mazda	616	1971-1970	
	Conquest	1986-1984		618	1972	
	D50	1982-1979		626	1987-1986	
	Mini Ram	1986-1984		808	1977-1972	
	Power Ram 50	1986-1983		1800	1971-1970	
	Raider	1989-1987		B1600	1976-1972	
Ram 50	1993-1983	B1800		1978-1977		
Eagle	2000 GTX	1993-1991		GLC	1978-1977	
	Summit	1990-1989		Mizer	1977-1976	
	Talon	1998-1990		Mercedes-Benz	200	1967-1966
Fiat	124	1981-1967	220		1973-1968	
	128	1979-1971	230		1969-1966	
	131	1978-1975	230S		1967-1966	
	Brava	1981-1979	230SL		1966-1963	
	Strada	1982-1979	250		1972-1968	
	X-1/9	1983-1974	250C		1972-1970	
Ford	Aspire	1997-1994	250S		1967-1966	
	Festiva	1993-1988	250SE		1967-1966	
Geo	Metro	1997-1989	250SL		1967	
	Storm	1993-1990	280		1974-1973	
Honda	600	1972-1969	280C		1974-1973	
	Accord	1985	280S		1971-1968	
	Civic	1979-1973	280SE		1973-1968	
	Civic	1987-1985	280SEL		1973-1968	
	Prelude	1987-1984	280SL	1971-1968		
Hyundai	Elantra	1995-1992	300SEL	1973-1968		



7084 (Cont'd)	BPR6EGP	G-Power	7084 (Cont'd)	BPR6EGP	G-Power
Qty per Vehicle: 2-12			Qty per Vehicle: 2-12		
		Box Qty: 4			Box Qty: 4
Mercedes-Benz	350SL	1972	Renault	Encore	1986-1985
	600	1972-1967		Fuego	1983-1982
MG	MGB	1981-1962		R5	1986
	MGC	1969-1968		R12	1977-1975
	Midget	1974-1967		R15	1976-1975
Mitsubishi	Cordia	1988-1983		R17	1979-1975
	Diamante	1996-1992		R18	1981
	Eclipse	1999-1990		R18i	1983-1981
	Expo	1992	Rover	3500	1980
	Galant	1992-1989	Saab	95	1973-1968
	Galant	1994		96	1973-1967
	Mighty Max	1996-1983		99	1980-1969
	Mirage	1992-1985		900	1984-1979
	Montero	1989-1986		900	1986
	Precis	1994-1987		Monte Carlo	1967
	Starion	1988-1983		Sonett	1974-1968
	Tredia	1988-1983	Subaru	Brat	1987-1978
	Van	1990-1987		Deluxe	1973-1972
Morgan	4/4	1981-1980		DL	1989-1974
	Plus 8	1996-1976		FE	1979
Morris	Minor	1971-1970		GF	1979-1975
Nissan	200SX	1983-1977		GL	1975-1972
	240Z	1973-1970		GL	1989-1979
	260Z	1975-1974		GL-10	1989-1985
	280ZX	1983-1980		GLF	1982-1980
	510	1981-1978		Justy	1990-1987
	610	1976-1974		Justy	1995
	620	1979-1975		Loyale	1994-1990
	710	1977-1974		RX	1989-1986
	720	1986-1980		Standard	1987-1976
	810	1981-1980		Star	1972-1971
	B210	1974		XT	1991-1985
	D21	1989-1986	Suzuki	Forsa	1988-1985
	Maxima	1984-1981		SA310	1985
	Pathfinder	1988-1987		Swift	1994-1989
	Pulsar NX	1984-1983	Toyota	2000GT	1970-1967
	Sentra	1988-1987		Celica	1974-1971
	Stanza	1983-1982		Corona	1971-1967
	Van	1988-1987		Crown	1966-1964
Peugeot	404	1970-1961		Land Cruiser	1966-1965
	504	1979-1970		Pickup	1970-1969
	505	1987-1980		Stout	1968-1966
	505	1991-1990	Triumph	TR6	1976-1969
Plymouth	Arrow	1980-1976		TR250	1968
	Arrow Pickup	1982-1979	Volkswagen	411	1972-1971
	Champ	1982-1979		412	1974-1973
	Colt	1994-1976		Cabriolet	1993-1985
	Conquest	1986-1984		Corrado	1992-1990
	Cricket	1973-1971		Dasher	1980-1975
	Horizon	1983		Golf	1986-1985
	Laser	1994-1990		Golf	1992-1988
	Sapporo	1979-1978		Jetta	1984-1980
	Turismo	1983		Passat	1991
Pontiac	Firefly	1991-1987		Passat	1993
	Firefly	2000-1994		Quantum	1987-1982
Porsche	911	1973-1972		Rabbit	1984-1980
	911	1989-1984		Rabbit Convertible	1984-1980
	911	1992-1991		Rabbit Pickup	1983-1980
	912	1976		Scirocco	1983-1980
	924	1988-1987	Volvo	240	1993-1990
	928	1991-1983		242	1984-1976
	928	1995-1993		244	1989-1976
	944	1991-1985		245	1989-1976
	968	1995-1992		264	1981-1980
Renault	Alliance	1987-1985		740	1992-1985



7084 (Cont'd)	BPR6EGP	G-Power
Qty per Vehicle: 2-12		Box Qty: 4
Volvo	745	1985
	760	1987
	780	1991-1989
	940	1995-1991

7086	BCPR5EGP	G-Power
Qty per Vehicle: 4-6		Box Qty: 4
Acura	Integra	1991-1990
Chevrolet	Nova	1988
Geo	Prizm	1992-1990
Honda	CRX	1991-1988
	Prelude	1990-1988
Nissan	200SX	1988-1984
	D21	1989-1986
	Multi	1988-1986
	Pathfinder	1989-1987
	Pulsar NX	1990-1989
	Sentra	1990-1989
	Stanza	1989-1984
Saab	900	1994-1992
Toyota	4Runner	1988
	Camry	1991-1987
	Celica	1993-1986
	Corolla	1992-1985
	Cressida	1992-1989
	MR2	1989-1985
	Supra	1992-1986

7088	BCPR6EGP	G-Power
Qty per Vehicle: 4-8		Box Qty: 4
Acura	Integra	1989-1986
	Legend	1990-1986
Aston Martin	Virage	1994-1990
Honda	Civic	1991-1988
	CRX	1991-1988
	Prelude	1990-1988
Lexus	ES250	1991-1990
	ES300	1993-1992
Mazda	323	1989-1988
Morgan	4/4	1994-1982
Nissan	200SX	1988-1984
	300ZX	1989-1984
	Maxima	1988-1985
	Multi	1988-1986
	Pulsar NX	1989-1987
	Stanza	1989-1984
Peugeot	405	1991-1989
Saab	9-3	2003-1999
	9-5	2009-1999
	900	1998-1985
	9000	1994-1986
Sterling	825	1988-1987
	827	1991-1989
Toyota	Camry	1993-1988
	MR2	1989-1988
	Supra	1992-1987

7090	BKR5EGP	G-Power
Qty per Vehicle: 4-24		Box Qty: 4
Acura	RL	2004-1996
	SLX	1999-1996
	TL	1998-1995
	Vigor	1994-1992
Bentley	Arnage	2009-2000
	Azure	2003-1996
	Azure	2008-2006
	Brooklands	1998-1993

7090 (Cont'd)	BKR5EGP	G-Power
Qty per Vehicle: 4-24		Box Qty: 4
Bentley	Continental	2003-1985
	Corniche	1984
	Eight	1984
	Eight	1991-1986
	Mulsanne	1992-1984
	Turbo R	1998-1988
	Cadillac	Catera
Chevrolet	Beretta	1994-1992
	Corvette	1992-1990
	Prizm	2002-1998
	Tracker	2004-2001
Chrysler	Cirrus	2000-1995
	Crossfire	2008-2004
	Sebring	2005-1995
Dodge	Avenger	2000-1995
	Colt	1994-1993
	Ram 2500	1996-1995
	Ram 3500	1997-1996
	Stratus	2000-1995
	Eagle	Summit
Ford	Taurus	1995-1989
	Thunderbird	2005-2002
Geo	Prizm	1989
	Prizm	1997-1993
	Storm	1993-1992
Honda	Civic	2005-2003
	Passport	2002-1997
Hyundai	Accent	2011-1995
	Azera	2011-2006
	Elantra	2007-1996
	Entourage	2010-2007
	Santa Fe	2009-2001
	Scoupe	1995-1993
	Sonata	2010-1999
	Tiburon	2001-1997
	Tiburon	2008-2003
	Tucson	2009-2005
	Veracruz	2012-2007
	XG300	2001
	XG350	2005-2002
Infiniti	G20	2002-1999
	I30	2001-1996
	J30	1997-1993
	Q45	2001-1990
	QX4	2000-1997
Isuzu	Amigo	2000-1998
	Axiom	2003-2002
	Rodeo	2004-1996
	Rodeo Sport	2003-2001
	Trooper	2002-1996
	VehiCROSS	2001-1999
	Jaguar	S-Type
Jaguar	Super V8	2009-2005
	Vanden Plas	2009-1997
	XF	2010-2009
	XJ8	2009-1998
	XJR	1997
	XJR	2009-2004
	XK	2009-2007
	XK8	2006-1997
	XKR	2002-2000
	XKR	2009-2004
Jeep	Cherokee	1990-1987
	Comanche	1990-1987
	Wagoneer	1990-1987



7090 (Cont'd)		BKR5EGP	G-Power	7090 (Cont'd)		BKR5EGP	G-Power
Qty per Vehicle: 4-24			Box Qty: 4	Qty per Vehicle: 4-24			Box Qty: 4
Kia	Amanti		2009-2004	Mercedes-Benz	E55 AMG		2002-1999
	Magentis		2008-2001		E320		2005-1994
	Optima		2008-2001		E420		1995-1994
	Rio		2011-2006		E420		1997
	Rio5		2011-2006		E430		2002-1998
	Rondo		2008-2007		E500		1994
	Sedona		2012-2002		E500		2006-2003
	Sedona		2014		G55 AMG		2004-2003
	Sephia		1997-1995		G500		2008-2002
	Sorento		2009-2003		ML55 AMG		2003-2000
	Spectra		2007-2004		ML320		2003-1998
	Spectra5		2007-2005		ML350		2005-2003
	Sportage		1995		ML430		2001-1999
	Sportage		2010-2005		ML500		2004-2002
Land Rover	LR3		2009-2005	ML500		2007	
	Range Rover		2009-2006	R500		2007-2006	
	Range Rover Sport		2009-2006	S55 AMG		2002-2001	
Lexus	GS300		2000-1994	S320		1999-1994	
	LX450		1997-1996	S420		1999-1994	
	SC300		1992	S430		2006-2000	
	SC300		2000-1994	S500		2006-1994	
Lincoln	LS		2006-2000	S600		1999-1994	
Mazda	2		2014-2011	S600		2001	
	323		1991-1990	SL320		1997-1994	
	323		1994-1993	SL500		2006-1994	
	626		2002-1993	SL600		2002-1994	
	929		1995-1992	SLK320		2004-2001	
	Miata		1997-1994	Mercury	Villager		2002-1993
	Miata		2005-1999	Mitsubishi	Diamante		2004-1997
	MPV		1998-1996	Eclipse		2005-1996	
	MX-3		1996-1992	Expo		1995-1993	
	MX-6		1997-1993	Expo LRV		1994-1992	
	Protege		2003-1990	Galant		2003-1992	
	Protege5		2003-2002	Lancer		2007-2002	
	Mercedes-Benz	300CE		1993-1990	Lancer		2017-2009
		300E		1993	Mirage		2002-1993
300SE			1993-1992	Montero		2002-1994	
300SL			1993-1990	Montero Sport		2004-1997	
300TE			1993	Outlander		2003	
400E			1993-1992	Outlander		2013-2008	
400SE			1992	Outlander Sport		2017-2015	
400SEL			1993	RVR		2017-2015	
500E			1993-1992	Nissan	240SX		1998-1991
500SEC			1993	300ZX		1996-1990	
500SEL			1993-1992	Altima		2001-1993	
500SL			1993-1990	Frontier		2004-1998	
600SEC			1993	Maxima		2001-1992	
600SEL			1993-1992	NX		1993-1991	
600SL			1993	Pathfinder		2000-1996	
C36 AMG			1997-1995	Quest		2002-1993	
C43 AMG			2000-1998	Sentra		2001-1991	
C220			1996-1994	Xterra		2004-2000	
C230			1998-1997	Oldsmobile	Achieva		1994-1992
C240			2005-2001	Peugeot	405		1991-1989
C280			2000-1994	Plymouth	Colt		1994-1993
C320			2005-2001	Pontiac	Grand Am		1994-1993
CL55 AMG			2002-2001	Vibe		2008-2003	
CL500			2006-1998	Rolls-Royce	Corniche		2002-2000
CL600			1999-1998	Silver Dawn		1997-1995	
CL600			2001	Saab	9-2X		2006-2005
CLK55 AMG			2002-2001	Saturn	L300		2005-2001
CLK320			2005-1998	LS2		2000	
CLK430			2003-1999	LW2		2000	
CLK500			2006-2003	LW300		2003-2001	
CLS500			2006	SC		1992-1991	



7090 (Cont'd)		BKR5EGP	G-Power	7092 (Cont'd)		BKR6EGP	G-Power
Qty per Vehicle: 4-24			Box Qty: 4	Qty per Vehicle: 4-24			Box Qty: 4
Saturn	SC2		2002-1993	Audi	A5 Quattro		2010-2008
	SL2		2002-1991		A6		2004-1998
	SW2		2001-1993		A6		2011-2009
	Vue		2003-2002		A6 Quattro		1996-1995
Scion	xA		2006-2004		A6 Quattro		2006-1998
	xB		2006-2004		A8 Quattro		2006-1997
	xB		2015-2012		Allroad Quattro		2005-2003
Subaru	Baja		2006-2004		Cabriolet		1996-1995
	Forester		1998	Coupe Quattro		1991-1990	
	Forester		2010-2005	Q5		2012-2009	
	Impreza		1998	S4		2009-2004	
	Impreza		2011-2005	S6		2003-2002	
	Legacy		1999-1996	S8		2003-2001	
	Legacy		2009-2004	Bentley	Arnage		1999
Suzuki	Outback		2009-2004	BMW	318i		1999-1991
	Aerio		2007-2002	318is		1999-1991	
	Grand Vitara		2005-2000	318ti		1999-1995	
	SX4		2009-2007	320i		1995-1992	
	Vitara		2004-2000	320i		2005-2001	
	XL-7		2003-2002	323Ci		2000	
Toyota	4Runner		2002-1989	323i		2000-1998	
	Celica		1990	323is		1999-1998	
	Celica		1997-1994	325Ci		2006-2001	
	Celica		2005-2000	325i		1995-1992	
	Corolla		2008-1993	325i		2005-2001	
	Corolla		2012	325is		1995-1992	
	Echo		2005-2000	325xi		2005-2001	
	Land Cruiser		1997-1993	328Ci		2000	
	Matrix		2008-2003	328i		2000-1996	
	Matrix		2013-2012	328is		1999-1996	
	MR2		1991	330Ci		2006-2001	
	MR2 Spyder		2005-2000	330i		2005-2001	
	Paseo		1999-1992	330xi		2005-2001	
	Pickup		1995-1988	525i		1995-1991	
	Previa		1995-1991	525i		2005-2001	
	Prius		2009-2001	525iT		1993	
	Supra		1998-1993	528i		2000-1997	
	T100		1998-1993	530i		1995-1994	
	Tacoma		2004-1995	530i		2005-2001	
	Tercel		1999-1995	540i		1995-1994	
Tundra		2004-2000	540i		2003-1997		
Yaris		2017-2006	545i		2005-2004		
Volkswagen	Beetle		2004	645Ci		2005-2004	
	Cabrio		2001-1995	740i		1995-1993	
	Corrado		1995-1992	740i		2001-1997	
	EuroVan		1997	740iL		2001-1993	
	EuroVan		2001-1999	745i		2005-2002	
	EuroVan		2003	745Li		2005-2002	
	Golf		1999-1994	750iL		2001-1998	
	Golf		2002-2001	760i		2006-2004	
	Jetta		2002-1993	760Li		2008-2003	
	Passat		1997-1993	840Ci		1997-1994	
<b>7092</b>	<b>BKR6EGP</b>	<b>G-Power</b>	M3		1999-1994		
Qty per Vehicle: 4-24			Box Qty: 4	M5		2003-2000	
Acura	Integra		2001-1992	X3		2006-2004	
	Legend		1995-1991	X5		2006-2000	
	NSX		2005-1991	Z3		2002-1996	
Alfa Romeo	164		1995-1991	Z4		2005-2003	
Aston Martin	DB9		2005	Z8		2003-2000	
Audi	90 Quattro		1992-1990	Cadillac	CTS		2004-2003
	A4		1997-1996	Chevrolet	Aveo		2008-2004
	A4		2005-1999	Aveo5		2008-2006	
	A4 Quattro		1996	Cobalt		2007-2005	
	A4 Quattro		2006-1998	Epica		2006-2004	
	A4 Quattro		2009	Metro		2001-1998	





7092 (Cont'd)		BKR6EGP	G-Power	7092 (Cont'd)		BKR6EGP	G-Power
Qty per Vehicle: 4-24			Box Qty: 4	Qty per Vehicle: 4-24			Box Qty: 4
Chevrolet	Optra		2007-2004	Lexus	LS400		2000-1990
	Tracker		1991-1989		LS430		2006-2001
	Tracker		2002-1998		LX470		2007-1998
Chrysler	Cirrus		2000		RX300		2003-1999
	Crossfire		2006-2005		RX330		2006-2004
	Neon		2002-2000		RX400h		2008-2006
	Sebring		1999-1995		SC300		1994-1993
	Sebring		2005-2001		SC400		2000-1992
Daewoo	Lanos		2002-1999		SC430		2010-2002
	Leganza		2002-1999		Lotus	Elan	
	Nubira		2002-1999	Elise			2007-2005
Daihatsu	Charade		1992-1989	Esprit			2003-1997
	Rocky		1992-1990	Exige			2006
Dodge	Avenger		1999-1995	Maybach	57		2012-2003
	Colt		1994-1993		62		2012-2003
	Dakota		2007-2005	Mazda	Miata		1993-1990
	Neon		2005-1995		Protege		1994-1990
	Stealth		1996-1991	Mercedes-Benz	C32 AMG		2004-2002
	Stratus		2005-1995		C55 AMG		2006-2005
	SX 2.0		2005-2003		C230		2002
Eagle	Talon		1998-1995		CL65 AMG		2006-2005
	Ford	Escort			1996-1991	CL65 AMG	
Probe			1997-1993		CL600		2014-2002
Geo	Prizm		1992-1990		CLK55 AMG		2006-2003
	Storm		1991-1990		G65 AMG		2017-2016
	Tracker		1997-1994		Maybach S600		2017-2016
GMC	Tracker		1991-1989		S65 AMG		2013-2006
Honda	Civic		2000-1999	S65 AMG		2017-2015	
	Civic del Sol		1997-1994	S600		2013-2002	
	CR-Z		2016-2011	S600		2017-2015	
	Passport		1996-1994	SL65 AMG		2011-2005	
Hyundai	Scoupe		1995-1993	SL65 AMG		2017-2013	
Infiniti	G20		1996-1991	SL600		2011-2004	
	M30		1992-1990	SLK32 AMG		2004-2002	
Isuzu	I-Mark		1989	SLK55 AMG		2011-2005	
	Impulse		1992-1990	SLK230		2004-2001	
	Rodeo		1995-1993	Mercury	Capri		1994-1991
	Rodeo		2003		Tracer		1996-1991
	Rodeo Sport		2003	Mini	Cooper		2008-2002
	Stylus		1992-1991		Mitsubishi	3000GT	
	Trooper		1995-1992	Diamante			1995-1992
Jaguar	Vanden Plas		1996-1988	Eclipse			2000-1995
	Vanden Plas		2003	Eclipse			2012-2003
	XJ6		1997-1987	Endeavor			2008-2004
	XJR		1996-1995	Endeavor			2011-2010
	XJR		2003-1998	Galant			2000-1999
	XJS		1996-1992	Galant			2009-2004
	XKR		2003	Lancer			2017-2008
Jeep	Grand Cherokee		2004-2002	Montero			1996-1995
Kia	Rio		2005-2001	Montero		2006-2003	
	Sephia		2001-1998	Montero Sport		1998-1997	
	Spectra		2004-2000	Outlander Sport		2017-2011	
	Sportage		2002-1995	RVR		2017-2011	
Land Rover	Discovery		2004-1999	Morgan	Aero 8		2005-2004
	Freelander		2005-2002		Nissan	200SX	
	Range Rover		2005-2003	D21		1994-1990	
Lexus	ES300		2003-1994	Frontier		2004-2001	
	ES330		2006-2004	Maxima		1994-1989	
	GS300		1993	NX		1993-1991	
	GS300		2005-2001	Pathfinder		1995-1990	
	GS400		2000-1998	Pickup		1995	
	GS430		2007-2001	Sentra		1994-1991	
	GX470		2009-2003	Sentra		1999-1998	
	HS250h		2012-2010	Xterra		2004-2002	
	IS300		2005-2001	Plymouth	Breeze		2000-1996



7092 (Cont'd)	BKR6EGP	G-Power
Qty per Vehicle: 4-24		Box Qty: 4
Plymouth	Colt	1994-1993
	Neon	2001-1995
Pontiac	Sunrunner	1997-1995
	Vibe	2006-2003
	Vibe	2010-2009
	Wave	2008-2005
	Wave5	2007-2005
Porsche	911	1994-1990
	911	1997-1996
	911	2005-1999
	911	2009-2007
	Boxster	2004-1997
	Carrera GT	2005-2004
Rolls-Royce	Cayenne	2006-2003
	Park Ward	2002
Saab	Phantom	2013-2004
	Silver Seraph	2002-1999
	9-2X	2005
Saturn	9-3	2011-2004
	9-3X	2011-2010
	900	1997-1994
	9000	1997-1995
Scion	Ion	2007-2004
Subaru	tC	2010-2005
	xB	2012-2008
Suzuki	Baja	2003
	Forester	2004-1999
	Impreza	2005-1993
	Legacy	2003-1990
	Legacy	2012-2010
	Outback	2003-2000
	Outback	2012-2010
	SVX	1997-1992
Toyota	Esteem	2002-1995
	Forenza	2008-2004
	Grand Vitara	1999
	Grand Vitara	2008-2006
	Reno	2008-2005
	Sidekick	1998-1993
	Swift	1993-1992
	Swift	2001-1995
	Swift+	2008-2004
	Verona	2006-2004
	Vitara	2002-1999
X-90	1998-1996	
XL-7	2006-2004	
Toyota	4Runner	2009-2003
	Avalon	2004-1995
	Camry	2011-1992
	Celica	2005-1990
	Corolla	1992-1990
	Corolla	2006-2005
	Corolla	2012-2009
	Highlander	2010-2001
	Land Cruiser	2007-1998
	Matrix	2006-2003
	Matrix	2012-2009
	MR2	1995-1991
	Previa	1997-1995
	RAV4	2008-1996
	Sequoia	2009-2001
	Sienna	2006-1998
	Solara	2008-1999
	Supra	1998-1993
	Tundra	2009-2000

7092 (Cont'd)	BKR6EGP	G-Power	
Qty per Vehicle: 4-24		Box Qty: 4	
Volkswagen	Beetle	2001	
	Beetle	2003	
	Golf	1986	
	Golf	1993-1990	
	Golf	2001-2000	
	Jetta	1992-1990	
	Jetta	2001	
	Passat	1991-1990	
	Passat	2005-1998	
	Phaeton	2006-2004	
	Touareg	2007-2004	
	Volvo	850	1997-1993
		960	1997-1992
C70		2004-1998	
S40		2004-2000	
S60		2009-2001	
S70		2000-1998	
S80		2010-1999	
S90		1998-1997	
V40		2004-2000	
V70		2007-1998	
V90		1998-1997	
XC70		2007-2003	
XC90	2011-2003		
<b>7094 ZFR6AGP G-Power</b>			
Qty per Vehicle: 4-6		Box Qty: 4	
Mazda	626	1989-1988	
	929	1991-1988	
	B2600	1989	
	MPV	1989	
	MX-6	1989-1988	
<b>7096 ZFR5EGP G-Power</b>			
Qty per Vehicle: 4-6		Box Qty: 4	
Nissan	240SX	1990-1989	
	300ZX	1996-1990	
	Axxess	1995-1990	
	D21	1994-1990	
	Pickup	1997-1995	
	Stanza	1992-1990	
<b>7098 ZFR5FGP G-Power</b>			
Qty per Vehicle: 4-12		Box Qty: 4	
Acura	CL	1999-1997	
	CL	2003-2001	
	EL	2000-1997	
	Integra	2001-1992	
	MDX	2002-2001	
	TL	2003-1999	
BMW	750iL	1996-1988	
	850Ci	1997-1993	
	850CSi	1995-1994	
	850i	1992-1991	
Chrysler	200	2014-2011	
	Sebring	2007	
	Sebring	2010-2009	
Dodge	Avenger	2014-2008	
	Caliber	2012-2007	
	Dakota	2007-2003	
	Journey	2017-2009	
	Ram 2500	1996-1994	
	Ram 3500	1996-1994	
Honda	Accord	2002-1990	
	Civic	2000-1992	
	Civic del Sol	1997-1993	
	CR-V	1998-1997	



7098 (Cont'd)		ZFR5FGP	G-Power	7131	BPR6ES	Standard	
Qty per Vehicle: 4-12			Box Qty: 4	Qty per Vehicle: 2-12			
Honda	Odyssey		2004-1995	Alfa Romeo	2600	1967	
	Pilot		2005-2003		Alfetta	1977-1975	
	Prelude		1996-1990		GTV-6	1986-1981	
Hyundai	Elantra		2012-2007		Milano	1989-1987	
	Oasis		1999-1996		Montreal	1975-1971	
Jeep	Compass		2017-2007		Sport	1979-1978	
	Patriot		2017-2007		Sprint	1979-1977	
Kia	Soul		2011-2010		Aston Martin	DB4	1963-1958
	Spectra		2009-2008			DB5	1965-1963
	Spectra5		2009-2008			DB6	1970-1965
Mazda	626		2002-1993	DBS		1971-1967	
	929		1991-1990	Lagonda		1978-1977	
	B2600		1993-1990	V-8		1978-1972	
	Millenia		2002-1995	V-8		1982	
	MPV		1995-1990	Vantage		1974-1972	
	MX-6		1997-1993	Audi	100 Series	1971-1969	
Protege		2003-1999	4000		1983-1980		
Mitsubishi	Raider		2007-2006		5000	1983-1978	
	Astra		2009-2008		5000	1988-1985	
7100	ZFR6FGP	G-Power	Qty per Vehicle: 4-10		Box Qty: 4	5000 Quattro	1986
						Coupe	1987-1981
						Super 90	1972-1969
Acura	CL		2003-2001		Austin	America	1972-1968
	EL		2005-2001	Marina		1975-1973	
	TL		2003-2002	Mini		1966-1960	
BMW	550i		2010-2006	Mini 850		1966-1960	
	650i		2010-2006	Mini Cooper		1969-1962	
	750i		2008-2006	Austin Healey	3000	1967-1959	
	750Li		2008-2006		Sprite	1970-1962	
X5		2010-2004	Bertone	X-1/9	1989-1984		
Chevrolet	Aveo		2011-2009	BMW	1600	1971-1964	
	Aveo5		2011-2009		1600-2	1971-1966	
Chrysler	Aspen		2007		1600ti	1968-1966	
Dodge	B1500		1998-1997		1602	1971-1967	
	B2500		1998-1997		1800	1971-1968	
	B3500		1998-1997		1802	1971	
	Colt		1992		2000	1972-1966	
	Dakota		2010-1997		2000c	1969-1968	
	Durango		2009-1998		2000cs	1969-1968	
	Nitro		2011-2007		2000ti	1971-1968	
	Ram 1500		2010-1997		2000tii	1972-1969	
	Ram 1500 Van		2003-1999		2002	1976-1966	
	Ram 2500		2003-1997		2002ti	1971-1968	
	Ram 2500 Van		2003-1999		2002tii	1974-1971	
	Ram 3500		2003-1997	2800CS	1971-1968		
	Ram 3500 Van		2003-1999	Buick	Opel	1979-1976	
Ford	Probe		1997-1989	Citroen	SM	1975-1971	
Honda	Civic		2005-2001	Daewoo	Lanos	2002-1999	
	CR-V		2001-1999	Dodge	Colt	1980-1971	
	Prelude		2001-1992	Eagle	Talon	1994-1990	
Jeep	Commander		2010-2006	Fiat	124	1981-1967	
	Grand Cherokee		2010-1999		128	1979-1971	
	Liberty		2012-2002		131	1978-1975	
Mazda	626		1992-1990		Brava	1981-1979	
	MX-6		1992-1990		Strada	1982-1979	
	Protege		2003		X-1/9	1983-1974	
Mitsubishi	Raider		2009-2006	Honda	600	1972-1969	
Plymouth	Colt		1992		Civic	1979-1973	
Pontiac	G3		2010-2009	Hyundai	Pony	1987-1983	
	G3 Wave		2009		Stellar	1987-1985	
Ram	1500		2013-2011	Jaguar	XJ12	1979-1973	
	Dakota		2011		XJS	1976	
Suzuki	Swift+		2009		XJS	1979	
					XKE	1974-1971	
				Jensen	Healey	1976-1972	



7131 (Cont'd)		BPR6ES	Standard	7131 (Cont'd)		BPR6ES	Standard	
Qty per Vehicle: 2-12			Box Qty: 4	Qty per Vehicle: 2-12			Box Qty: 4	
Lada	1300		1983	Nissan	620		1979-1975	
	Niva		1993-1984		710		1976-1974	
	Samara		1993-1988		720		1986-1980	
	Signet		1993-1984		B210		1974	
Lancia	Beta		1979-1976	Peugeot	D21		1989-1986	
	Beta		1981		Pathfinder		1988-1987	
	Zagato		1979		Van		1988-1987	
	Zagato		1982-1981		404		1970-1961	
Land Rover	Discovery		1999-1994	Porsche	504		1979-1970	
Lotus	Eclat		1979-1976		505		1987-1980	
	Elite		1966-1958		505		1991-1990	
	Esprit		1979-1976	Plymouth	Arrow		1977-1976	
	Esprit		1989-1982		Colt		1980	
	Seven		1975-1962		Cricket		1973-1971	
Super Seven		1968-1962	Laser			1994-1990		
Maserati	Bora		1983-1971	Porsche	911		1973-1972	
	Ghibli		1973-1967		911		1989-1984	
	Indy		1974-1969		911		1992-1991	
	Khamsin		1979-1974		912		1976	
	Merak		1982-1972		924		1988-1987	
	Mexico		1971-1967		928		1991-1983	
	Quattroporte		1969-1968		928		1995-1993	
	Quattroporte		1986-1979		944		1991-1985	
Mazda	616		1971-1970	Renault	968		1995-1992	
	618		1972		Alliance		1987-1985	
	626		1987-1986		Encore		1986-1985	
	808		1977-1972		Fuego		1983-1982	
	1800		1971-1970		R5		1986	
	B1600		1976-1972		R12		1977-1975	
	B1800		1978-1977		R15		1976-1975	
	GLC		1978-1977		R17		1979-1975	
	Mizer		1977-1976		R18		1981	
Mercedes-Benz	200		1967-1966	Rover	R18i		1983-1981	
	220		1973-1968		3500		1980	
	230		1969-1966	Saab	95		1973-1968	
	230S		1967-1966		96		1973-1967	
	230SL		1966-1963		99		1980-1969	
	250		1972-1968		900		1984-1979	
	250C		1972-1970		900		1986	
	250S		1967-1966		Monte Carlo		1967	
	250SE		1967-1966		Sonett		1974-1968	
	250SL		1967		Subaru	Brat		1980-1978
	280		1974-1973			Deluxe		1973-1972
	280C		1974-1973			DL		1979-1974
	280S		1971-1968	FE			1979	
	280SE		1973-1968	GF			1979-1975	
	280SEL		1973-1968	GL			1975-1972	
	280SL		1971-1968	GL			1980-1979	
	300SEL		1973-1968	GLF		1980		
	350SL		1972	Star		1972-1971		
	600		1972-1967	Suzuki	Forsa		1988-1985	
	MG	MGB			1981-1962	SA310		1985
MGC			1969-1968	Toyota	2000GT		1970-1967	
Midget			1974-1967		Celica		1974-1971	
Mitsubishi	Eclipse		1994-1990		Corona		1971-1967	
	Galant		1992-1991		Crown		1966-1964	
	Mirage		1989		Land Cruiser		1966-1965	
Morgan	4/4		1981-1980		Pickup		1970-1969	
	Plus 8		1996-1976		Stout		1968-1966	
Morris	Minor		1971-1970	Triumph	TR6		1976-1969	
Nissan	200SX		1983-1980		TR250		1968	
	240Z		1973-1970	Volkswagen	411		1972-1971	
	260Z		1975-1974		412		1974-1973	
	510		1981-1980		Cabriolet		1993-1985	
	610		1976-1974		Corrado		1992-1990	



7131 (Cont'd)		BPR6ES	Standard	7133 (Cont'd)		BPR6ES-11	Standard	
Qty per Vehicle: 2-12			Box Qty: 4	Qty per Vehicle: 3-6			Box Qty: 4	
Volkswagen	Dasher		1980-1975	Mitsubishi	Starion		1988-1983	
	Golf		1986-1985		Tredia		1988-1983	
	Golf		1992-1988		Van		1990-1987	
	Jetta		1984-1980	Nissan	200SX		1979-1977	
	Quantum		1987-1982		280ZX		1983-1980	
	Rabbit		1984-1980		510		1979-1978	
	Rabbit Convertible		1984-1980		610		1976-1975	
	Rabbit Pickup		1983-1980		710		1977-1975	
Scirocco		1983-1980	810			1981-1980		
Volvo	240		1993-1990		Maxima		1984-1981	
	242		1984-1976		Pulsar NX		1984-1983	
	244		1989-1976	Sentra		1988-1987		
	245		1989-1976	Stanza		1983-1982		
	264		1981-1980	Plymouth	Arrow		1980-1978	
	740		1992-1985		Arrow Pickup		1982-1979	
	745		1985		Champ		1982-1979	
	760		1987		Colt		1979-1976	
780		1991-1989	Colt			1994-1981		
940		1995-1991	Conquest			1986-1984		
<b>7133</b>			<b>BPR6ES-11</b>		<b>Standard</b>			
Qty per Vehicle: 3-6			Box Qty: 4					
Chevrolet	Metro		1992	Pontiac	Firefly		1991-1987	
	Metro		2000-1998		Firefly		2000-1994	
	Sprint		1992-1987		Subaru	Brat		1987-1981
Chrysler	Conquest		1988-1987			DL		1989-1980
	Dodge	2000 GTX				1990-1989	GL	
Challenger			1979-1978			GL-10		1989-1985
Colt			1991-1979			GLF		1982-1980
Conquest			1986-1984			Justy		1990-1987
D50			1982-1979	Justy			1995	
Mini Ram			1986-1984	Loyale			1994-1990	
Power Ram 50			1986-1983	RX		1989-1986		
Raider			1989-1987	Standard		1987-1976		
Ram 50		1993-1983	XT		1991-1985			
Eagle	2000 GTX		1993-1991	Suzuki	Swift		1994-1989	
	Summit		1990-1989	<b>7159</b>			<b>TR55-1GP</b>	<b>G-Power</b>
Ford	Aspire		1997-1994	Qty per Vehicle: 4-8			Box Qty: 4	
	Festiva		1993-1988	Buick	Century		1995-1994	
Geo	Metro		1997-1989		Chevrolet	Beretta		1996-1994
	Storm		1993-1990	Cavalier			1997-1994	
Honda	Accord		1985	Corsica			1996-1994	
	Civic		1987-1985	LLV			1995-1994	
	Prelude		1987-1984	S10			1997-1994	
Hyundai	Elantra		1995-1992	Ford	Country Squire		1991-1987	
	Excel		1994-1986		E-150 Econoline		2002-1998	
	Scoupe		1992-1991		E-150 Econoline Club Wagon		2002-1998	
Isuzu	Sonata		1998-1989		E-250 Econoline		2002-1998	
	Amigo		1989		Escort		2002-1991	
	I-Mark		1989-1981		Explorer		2010-2006	
	Impulse		1989-1983		Explorer Sport Trac		2010-2007	
	Pickup		1991-1981		F-150		2002-1998	
Mazda	Stylus		1993-1991		Focus		2004-2000	
	Trooper		1987-1984		Freestar		2007-2006	
Mitsubishi	Mizer		1976		LTD		1986-1985	
	Cordia		1988-1983		LTD Crown Victoria		1991-1987	
	Diamante		1996-1992		Mustang		1986-1985	
	Eclipse		1994-1990		Mustang		1997-1994	
	Expo		1992	Mustang		2010-2005		
	Galant		1992-1989	Ranger		2011-2001		
	Galant		1994	Taurus		1995-1988		
	Mighty Max		1996-1983	Thunderbird		1997-1985		
	Mirage		1992-1985	Windstar		1995		
	Montero		1989-1986	GMC	Sonoma		1997-1994	
	Precis		1994-1987					





7159 (Cont'd)	TR55-1GP	G-Power
Qty per Vehicle: 4-8		Box Qty: 4
Isuzu	Hombre	1997-1996
Land Rover	LR3	2009-2005
Lincoln	Continental	1994-1986
	Mark VII	1987-1985
	Town Car	1990-1986
Mazda	B4000	2002-2001
	B4000	2010-2004
Mercury	Capri	1986-1984
	Colony Park	1991-1987
	Cougar	1997-1985
	Grand Marquis	1991-1986
	Marquis	1986-1983
	Monterey	2007-2004
	Mountaineer	2010-2007
	Sable	1995-1988
Oldsmobile	Tracer	1999-1991
	Cutlass Ciera	1996-1994
Pontiac	Sunfire	1997-1995

7162	DR8EA	Standard
Qty per Vehicle: 4-12		Box Qty: 10
Chrysler	TC Maserati	1990-1989
Ferrari	328 GTB	1989-1985
	328 GTS	1989-1985
	330 GT	1968
	330 GTC	1968
	330 GTS	1968
	348 GTB	1994-1993
	348 GTS	1994-1993
	348 Spider	1995-1993
	348 TB	1992-1990
	348 TS	1992-1989
	Mondial 3.2	1988-1986
	Mondial 8	1985-1980
	Mondial t	1993-1989
Lamborghini	Diablo	2000-1997

7164	TR55IX	Iridium IX
Qty per Vehicle: 4-12		Box Qty: 4
Aston Martin	DB7	2003-2002
Buick	Allure	2009-2005
	Century	2005-1989
	Commercial Chassis	1996-1994
	Electra	1990-1988
	LaCrosse	2009-2005
	LeSabre	2005-1988
	Lucerne	2011-2006
	Park Avenue	2005-1991
	Reatta	1991-1988
	Regal	2004-1990
	Rendezvous	2007-2002
	Riviera	1993-1988
	Riviera	1999-1995
	Roadmaster	1996-1994
	SkyLark	1998-1989
	Terraza	2006-2005
Cadillac	60 Special	1993
	Allante	1993-1987
	Commercial Chassis	1996-1985
	DeVille	2005-1982
	DTS	2011-2006
	Eldorado	2002-1982
	Fleetwood	1992-1982
	Fleetwood	1996-1994
	Seville	2004-1982
	SRX	2009-2007

7164 (Cont'd)	TR55IX	Iridium IX
Qty per Vehicle: 4-12		Box Qty: 4
Cadillac	STS	2010-2007
	XLR	2009-2007
Chevrolet	Astro	2005-1996
	Avalanche 2500	2006-2002
	Beretta	1996-1994
	Blazer	2005-1996
	C1500	1999-1996
	C1500 Suburban	1997-1996
	C2500	1993-1992
	C2500	2000-1996
	C2500 Suburban	1999-1996
	C3500	2000-1996
	C3500HD	2002-2001
	C4500 Kodiak	2009-2008
	C5500 Kodiak	2009-2008
	C6500 Kodiak	2009-2008
	C7500 Kodiak	2009-2008
	Camaro	2002-1993
	Caprice	1996-1994
	Cavalier	2002-1995
	Corsica	1996-1994
	Corvette	1996-1992
	Equinox	2009-2005
	Express 1500	2014-1996
	Express 2500	2005-1996
	Express 3500	2002-1996
	G30	1995
	Impala	1996-1994
	Impala	2005-2000
	K1500	1999-1996
	K1500 Suburban	1997-1996
	K2500	1993-1992
	K2500	2000-1996
	K2500 Suburban	1999-1996
	K3500	2000-1996
	Lumina	2001-1995
	Lumina APV	1996-1992
	Malibu	2006-1997
	Monte Carlo	2005-1995
	P30	1999-1996
	S10	2004-1996
	Silverado 1500	2013-1999
	Silverado 1500 Classic	2007
	Silverado 2500 HD	2006-2001
	Silverado 2500 HD Classic	2007
Silverado 3500	2006-2001	
Silverado 3500 Classic	2007	
Suburban 2500	2006-2001	
Tahoe	1997-1996	
Uplander	2006-2005	
Venture	2005-1997	
Ford	Aerostar	1997-1990
	Contour	2000-1995
	Crown Victoria	2011-1992
	E-150	2014-2003
	E-150 Club Wagon	2005-2003
	E-150 Econoline	2002-1997
	E-150 Econoline Club Wagon	2002-1997
	E-250	2014-2003
	E-250 Econoline	2002-1997
	E-350 Club Wagon	2005-2003
	E-350 Econoline	1998-1997
	E-350 Econoline Club Wagon	2002-1997
	E-350 Super Duty	2017-1999
E-450 Econoline Super Duty	2002-1999	



7164 (Cont'd)	TR55IX	Iridium IX	7164 (Cont'd)	TR55IX	Iridium IX	
Qty per Vehicle: 4-12		Box Qty: 4	Qty per Vehicle: 4-12		Box Qty: 4	
Ford	E-450 Super Duty	2017-2003	Lincoln	Blackwood	2002	
	E-550 Econoline Super Duty	2002		Continental	2002-1995	
	E-550 Super Duty	2003		LS	2005-2000	
	Econoline Super Duty	1999-1997		Mark VIII	1998-1993	
	Escape	2008-2001		Navigator	2004-1998	
	Excursion	2005-2000		Town Car	2008-1991	
	Expedition	2004-1997		Town Car	2011	
	Explorer	2005-1991		Zephyr	2006	
	Explorer Sport	2003-2001		Mazda	5	2007-2006
	Explorer Sport Trac	2005-2001			6	2005-2003
	F53	2004-1999			B3000	2008-2004
	F-150	2009-1997	B4000		1996-1994	
	F-150 Heritage	2004	B4000		2003	
	F-250	1999-1997	MPV		2006-2002	
	F-250 Super Duty	2004-1999	Navajo		1994-1991	
	F-350 Super Duty	2004-1999	Tribute		2006-2001	
	F-450 Super Duty	2004-1999	Tribute		2008	
	F-550 Super Duty	2004-1999	Mercury		Cougar	1997-1994
	Fiesta	1979-1978		Cougar	2002-1999	
	Five Hundred	2007-2005		Grand Marquis	2011-1992	
	Focus	2011		Marauder	2004-2003	
	Freestar	2005-2004		Mariner	2008-2005	
	Freestyle	2007-2005		Milan	2009-2006	
	Fusion	2009-2006		Montego	2007-2005	
	Mustang	2004-1993		Mountaineer	2006-1997	
	Ranger	1996-1990		Mystique	2000-1995	
	Ranger	2008		Sable	2005-1996	
	Ranger	2011-2010	Topaz	1994-1989		
	Taurus	2005-1996	Oldsmobile	88	1999-1992	
	Tempo	1994-1989		98	1996-1988	
	Thunderbird	1997-1994		Achieva	1998-1992	
	Transit Connect	2013-2010		Alero	2004-1999	
	Windstar	2003-1996		Aurora	1999-1995	
GMC	C1500	1999-1996		Aurora	2003-2001	
	C1500 Suburban	1997-1996		Bravada	2001-1996	
	C2500	2000-1996		Cutlass	1999-1997	
	C2500 Suburban	1999-1996		Cutlass Calais	1991-1989	
	C3500	2000-1996		Cutlass Ciera	1996-1989	
	C3500HD	2002-1996	Cutlass Cruiser	1994-1989		
	C4500 Topkick	2009-2008	Cutlass Supreme	1997-1993		
	C5500 Topkick	2009-2008	Delta 88	1991-1988		
	C6500 Topkick	2009-2008	Intrigue	2002-1998		
	C7500 Topkick	2009-2008	LSS	1999-1996		
	Jimmy	2005-1996	Regency	1998-1997		
	K1500	1999-1996	Silhouette	2004-1992		
	K1500 Suburban	1997-1996	Toronado	1992-1988		
	K2500	2000-1996	Pontiac	Aztek	2005-2001	
	K2500 Suburban	1999-1996		Bonneville	2005-1988	
	K3500	2000-1996		Firebird	2002-1993	
	P3500	1999-1996		G6	2006-2005	
	Safari	2005-1996		Grand Am	2005-1992	
	Savana 1500	2014-1996		Grand Prix	2008-1994	
	Savana 2500	2005-1996		Montana	2006-1999	
	Savana 3500	2002-1996		Sunfire	2002-1995	
	Sierra 1500	2013-1999		Torrent	2009-2006	
	Sierra 1500 Classic	2007		Trans Sport	1999-1992	
	Sierra 2500 HD	2006-2001	Saturn	Relay	2006-2005	
	Sierra 2500 HD Classic	2007	<b>7177</b>	<b>UR5IX</b>	<b>Iridium IX</b>	
	Sierra 3500	2006-2001	Qty per Vehicle: 4-8		Box Qty: 4	
	Sierra 3500 Classic	2007	AM General	Hummer	1996-1995	
Sonoma	2004-1996	Buick	Century	1986-1983		
Yukon	1997-1996		Commercial Chassis	1993-1992		
Yukon XL 2500	2006-2001		Roadmaster	1993-1992		
Isuzu	Hombre		1999-1997	Skyhawk	1986-1982	
	Lincoln		Aviator	2005-2003	Skylark	1985-1980



7177 (Cont'd)		UR5IX	Iridium IX	7177 (Cont'd)		UR5IX	Iridium IX
Qty per Vehicle: 4-8			Box Qty: 4	Qty per Vehicle: 4-8			Box Qty: 4
Cadillac	Brougham		1992-1990	Chevrolet	V20 Suburban		1988-1987
	Cimarron		1986-1982		V30		1988-1987
	Commercial Chassis		1992		V1500 Suburban		1991-1989
Chevrolet	Astro		1995-1985		V2500 Suburban		1991-1989
	Bel Air		1971		V3500		1991-1989
	Biscayne		1971		Vega		1974-1971
	Blazer		1995-1987	Vega		1977-1976	
	C10		1986-1984	Dodge	M300		1974
	C10 Suburban		1986-1984	M350		1974	
	C20		1986-1985	Ford	B600		1989-1986
	C20 Suburban		1986-1984		B700		1989-1986
	C1500		1995-1988		Bronco		1975
	C1500 Suburban		1995-1992		Bronco		1996-1980
	C2500		1995-1988		C600		1986
	C2500 Suburban		1995-1992		C700		1986
	C3500		1995-1988		C800		1986
	C3500HD		1995-1991		E-100 Econoline		1975
	Camaro		1995-1982		E-100 Econoline		1982-1980
	Caprice		1971		E-100 Econoline Club Wagon		1982-1980
	Caprice		1993-1989		E-150 Econoline		1975
	Cavalier		1986-1982		E-150 Econoline		1996-1980
	Celebrity		1986-1982		E-150 Econoline Club Wagon		1996-1980
	Chevette		1987-1976		E-250 Econoline		1975
	Citation		1983-1980		E-250 Econoline		1996-1980
	Citation II		1985-1984		E-250 Econoline Club Wagon		1980
	Corvette		1971		E-250 Econoline Club Wagon		1991-1985
	Corvette		1987-1985		E-350 Econoline		1975
	EI Camino		1971		E-350 Econoline		1982-1980
	EI Camino		1986		E-350 Econoline		1996-1985
	G10		1995-1984		E-350 Econoline Club Wagon		1996-1985
	G20		1995-1984		Econoline Super Duty		1996
	G30		1996-1984		F53		1997
	K5 Blazer		1986-1984		F-100		1975
	K10		1986-1985		F-100		1983-1980
	K10 Suburban		1986-1984		F-150		1975
	K20		1986-1985		F-150		1996-1980
	K20 Suburban		1986-1984		F-250		1996-1980
	K30		1985		F-250 HD		1997
	K1500		1995-1988		F-350		1975
	K1500 Suburban		1995-1992		F-350		1980
	K2500		1995-1988		F-350		1997-1984
	K2500 Suburban		1995-1992		Falcon		1970
	K3500		1995-1988	F Super Duty		1997	
	Lumina APV		1995-1990	Mustang		1983	
	Monte Carlo		1971	Thunderbird		1983	
	Monte Carlo		1986-1985	GMC	C1500		1986-1984
	Monza		1977-1976		C1500		1995-1988
	P20		1989-1987		C1500 Suburban		1986-1984
	P30		1997-1987		C1500 Suburban		1995-1992
	P40		1988		C2500		1986-1985
R10		1987	C2500			1995-1988	
R10 Suburban		1988-1987	C2500 Suburban			1986-1985	
R20		1988-1987	C2500 Suburban			1995-1992	
R20 Suburban		1988-1987	C3500			1995-1988	
R30		1988-1987	C3500HD			1995-1991	
R1500 Suburban		1991-1989	Caballero			1986	
R2500		1989	G1500			1995-1984	
R2500 Suburban		1991-1989	G2500			1995-1984	
R3500		1991-1989	G3500			1996-1984	
S10		1995-1982	Jimmy			1995-1984	
S10 Blazer		1994-1983	K1500			1986-1985	
Tahoe		1995	K1500			1995-1988	
V10		1987	K1500 Suburban			1986-1984	
V10 Suburban		1988-1987	K1500 Suburban			1995-1992	
V20		1987	K2500			1986-1985	



7177 (Cont'd)		UR5IX	Iridium IX	7189 (Cont'd)		XR4IX	Iridium IX	
Qty per Vehicle: 4-8			Box Qty: 4	Qty per Vehicle: 6-8			Box Qty: 4	
GMC	K2500		1995-1988	Buick	Skylark		1954	
	K2500 Suburban		1995-1992		Skylark		1967-1965	
	K3500		1995-1988		Special		1958-1951	
	P25		1976		Special		1963-1962	
	P35		1976		Special		1967-1965	
	P2500		1989-1988		Sportwagon		1967-1965	
	P3500		1997-1987		Super		1958-1951	
	R1500		1987		Wildcat		1965-1963	
	R1500 Suburban		1991-1987		Cadillac	Calais		1967
	R2500		1989-1987			DeVille		1967
	R2500 Suburban		1991-1987			Eldorado		1967
	R3500		1991-1987	Fleetwood			1967	
	S15		1990-1982	Series 60 Fleetwood			1952-1950	
	S15 Jimmy		1991-1983	Series 61			1951-1950	
	Safari		1995-1985	Series 62			1952	
	Sonoma		1995-1991	Series 75 Fleetwood		1952-1950		
	Sprint		1971	Chevrolet	Bel Air		1969-1950	
	Syclone		1991		Biscayne		1969-1958	
	Typhoon		1993-1992		Camaro		1969-1967	
	V1500		1987		Caprice		1969-1966	
	V1500 Suburban		1991-1987		Chevelle		1968-1964	
	V2500		1987		Chevy II		1968-1963	
	V2500 Suburban		1991-1987		El Camino		1968	
V3500		1991-1987	Impala			1968-1959		
Yukon		1995-1992	Nova			1970		
Isuzu	Pickup		1994-1991		Chrysler	300		1969-1968
	Rodeo		1992-1991	Cordoba			1978-1975	
	Trooper		1991-1989	Imperial			1975-1959	
Jeep	Cherokee		1986-1984	Newport			1960-1959	
	Comanche		1986	Newport			1963-1962	
	Wagoneer		1986-1984	Newport			1978-1966	
Mercury	Cyclone		1971	New Yorker			1972-1959	
Oldsmobile	Bravada		1994-1991	New Yorker			1978-1975	
	Custom Cruiser		1992	Saratoga			1960-1957	
	Cutlass Ciera		1986-1982	Town & Country			1963-1957	
	Firenza		1986-1982	Town & Country			1972-1967	
	Omega		1984-1980	Town & Country			1977-1975	
	Silhouette		1994-1990	Windsor			1961-1957	
Pontiac	Starfire		1977-1976	Dodge		330		1964-1963
	6000		1986-1982			440		1964-1963
	Acadian		1987-1976			880		1965-1962
	Astre		1977-1976			B200 Van		1971
	Bonneville		1986		B200 Van		1974	
	Fiero		1988-1985		Challenger		1971-1970	
	Firebird		1995-1982		Charger		1976-1967	
	Grand Prix		1986		Coronet		1959-1953	
	J2000		1983-1982		Coronet		1976-1965	
	J2000 Sunbird		1985-1984		Custom		1961-1954	
	Parisienne		1986		D100 Pickup		1974-1968	
	Phoenix		1984-1980		D100 Series		1967	
	Sunbird		1977-1976		D200 Pickup		1974-1968	
	Sunbird		1986		D200 Series		1967	
	T1000		1987-1981		D300 Pickup		1974-1968	
	Trans Sport		1995-1990		D300 Series		1967	
<b>7189</b>			<b>XR4IX</b>		<b>Iridium IX</b>			
Qty per Vehicle: 6-8			Box Qty: 4					
Buick	Century		1958-1954		Dodge	Monaco		1978-1965
	Electra		1965-1959			Polara		1973-1960
	Gran Sport		1965			Royal Monaco		1977-1975
	Gran Sport		1967			W100 Pickup		1971-1968
	Invicta		1963-1959			W100 Pickup		1974
	LeSabre		1965-1959	W100 Series			1967	
	Limited		1958	W200 Pickup			1971-1969	
	Riviera		1965-1963	W200 Pickup			1974	
	Roadmaster		1958-1953	W200 Series			1967	
						W300 Pickup		1969-1968
				W300 Pickup			1971	



7189 (Cont'd)		XR4IX	Iridium IX	7214 (Cont'd)		GR5IX	Iridium IX	
Qty per Vehicle: 6-8			Box Qty: 4	Qty per Vehicle: 3-8			Box Qty: 4	
Dodge		W300 Series	1967	Chevrolet		Impala	1969-1961	
Jeep		CJ3	1966			K10 Pickup	1969-1968	
		CJ5	1971-1966			K10 Suburban	1969-1968	
		CJ6	1971-1966			K20 Pickup	1969-1968	
		Commando	1967-1966			K30 Pickup	1969-1968	
		Dispatcher	1967-1966			Malibu	1967-1966	
		DJ5	1970-1966			Nova	1970	
		DJ6	1968-1966			S10	1985-1982	
		FC150	1966			S10 Blazer	1984-1983	
		FC170	1966			Spectrum	1988-1985	
		Jeepster	1971-1966			Sprint	1988-1985	
		Universal	1967-1966		Dodge		Charger	1967
Oldsmobile		98	1974-1970			Coronet	1971-1967	
		442	1971-1970			Polara	1966	
		Custom Cruiser	1976-1971					
		Cutlass	1974-1968		Ford		Courier	1979-1972
		Cutlass Supreme	1974-1971				Courier	1981
		Delmont 88	1968				Mustang II	1976-1974
		Delta 88	1974-1968				Pinto	1973-1971
		F85	1972-1964				Pinto	1976-1975
		Omega	1974-1973		Geo		Spectrum	1989
		Toronado	1974-1968					
		Vista Cruiser	1975-1968		GMC		C15/C1500 Pickup	1969-1968
Plymouth		Barracuda	1964			C15/C1500 Suburban	1968	
		Belvedere	1966-1955			C25/C2500 Pickup	1969-1968	
		Custom	1961-1958			C25/C2500 Suburban	1968	
		Fleet Special	1963-1960			C35/C3500 Pickup	1969-1968	
		Fury	1958-1956			K15/K1500 Pickup	1969-1968	
		Fury	1966-1960			K15/K1500 Suburban	1968	
		Plaza	1958-1955			K25/K2500 Pickup	1969-1968	
		Satellite	1969-1965			K25/K2500 Suburban	1968	
		Savoy	1958-1955			K35/K3500 Pickup	1969-1968	
		Savoy	1964-1963			S15	1985-1982	
		Suburban	1958-1955			S15 Jimmy	1984-1983	
Pontiac		Bonneville	1971-1959		International	100	1974	
		Catalina	1971-1959			200	1974	
		Executive	1970-1967			1010	1973-1972	
		Firebird	1971-1967			1110	1973-1972	
		Grand Prix	1971-1962			1210	1973-1972	
		Grand Safari	1971			1310	1973-1972	
		Grandville	1971			M800 Post Office	1972	
		GTO	1966-1964			M1100	1972	
		GTO	1971-1970			M1200	1972	
		LeMans	1971-1963			MHC1310	1974	
		Star Chief	1966-1959			MS1210	1974-1972	
		Tempest	1961		Plymouth		Belvedere	1966
		Tempest	1968-1963				Cuda	1971-1970
		Tempest	1970				Fury	1966-1963
		Ventura	1961-1960				Satellite	1967-1965
					Pontiac		Firefly	1988-1985
							Grand Am	1989-1987
						J2000	1983-1982	
						J2000 Sunbird	1985-1984	
						Sunbird	1990-1986	
						Sunbird	1994-1992	
						Sunburst	1988-1985	
<b>7214</b>	<b>GR5IX</b>	<b>Iridium IX</b>		<b>7226</b>	<b>BPR7ES-11</b>	<b>Standard</b>		
Qty per Vehicle: 3-8			Box Qty: 4	Qty per Vehicle: 4			Box Qty: 4	
Buick		Skyhawk	1987-1982	Chrysler		Conquest	1989	
Chevrolet		Bel Air	1969-1961	Dodge		Colt	1990-1984	
		Biscayne	1969-1961					
		C10 Pickup	1969-1968	Mitsubishi		Cordia	1988-1984	
		C10 Suburban	1969-1968			Mirage	1988-1985	
		C20 Pickup	1969-1968			Starion	1989	
		C20 Suburban	1969-1968			Tredia	1988-1984	
		C30 Pickup	1969-1968					
		Camaro	1969-1967	Plymouth		Colt	1986-1984	
		Caprice	1969-1966					
		Chevle	1969-1966					
		Chevy II	1968					
		Corvette	1969-1966					
		El Camino	1970-1966					





7240			7240 (Cont'd)			
	YR55	V-Power		YR55	V-Power	
Qty per Vehicle: 6-8		Box Qty: 4	Qty per Vehicle: 6-8		Box Qty: 4	
Buick	Apollo	1975	GMC	G35/G3500 Van	1974	
Chevrolet	Bel Air	1975		Jimmy	1975	
	C10	1975		Jimmy	1978-1977	
	C10	1978-1977		K15	1975	
	C10 Suburban	1975		K15	1978-1977	
	C10 Suburban	1978-1977		K15 Suburban	1975	
	C20	1975		K15 Suburban	1977	
	C20	1978-1977		K25	1975	
	C20 Suburban	1975		K25	1978-1977	
	C20 Suburban	1978-1977		K25 Suburban	1975	
	C30	1975		K25 Suburban	1978-1977	
	C30	1978-1977		K35	1978-1977	
	Camaro	1975		P15	1975	
	Caprice	1975		P25	1975	
	Corvette	1975		P25	1978-1977	
	El Camino	1975		P35	1975	
	El Camino	1978		P35	1978-1977	
	G10	1978-1975		Sprint	1977-1975	
	G10 Van	1974		Oldsmobile	Cutlass	1975
	G20	1978-1975			Cutlass Supreme	1975
	G20 Van	1974			Omega	1975
	G30	1978-1975		Pontiac	Firebird	1975
	G30 Van	1974			Grand LeMans	1975
	Impala	1975			LeMans	1975
	K5 Blazer	1975			Ventura	1975
	K5 Blazer	1978-1977		<b>7243 TR5-1IX Iridium IX</b>		
	K10	1975		Qty per Vehicle: 4-6		Box Qty: 4
	K10	1978-1977		Buick	Century	1996
	K10 Suburban	1975		Ford	Aerostar	1987-1986
	K10 Suburban	1978-1977			E-150	2003
	K20	1975			E-150 Club Wagon	2003
	K20	1978-1977			E-250	2003
	K20 Suburban	1975			Escort	1990-1983
	K20 Suburban	1978-1977			EXP	1988-1983
K30	1978-1977	F-150	2003			
Laguna	1975	F-150	2007-2005			
Malibu	1975	F-150 Heritage	2004			
Monte Carlo	1975	Fairmont	1983			
Monza	1975	LTD	1986-1983			
Nova	1975	Mustang	1990-1983			
P10	1975	Ranger	1988-1983			
P10	1977	Thunderbird	1984			
P20	1975	Mercury	Capri	1986-1983		
P20	1978-1977		Cougar	1984-1983		
P30	1975		LN7	1983		
P30	1978-1977		Lynx	1987-1982		
GMC	C15	1975	Marquis	1986-1983		
	C15	1978-1977	Zephyr	1983		
	C15 Suburban	1975	<b>7252 FR5-1 V-Power</b>			
	C15 Suburban	1978-1977	Qty per Vehicle: 4-10		Box Qty: 4	
	C25	1975	American Motors	Concord	1983-1981	
	C25	1978-1977		Eagle	1988-1980	
	C25 Suburban	1975		Spirit	1983-1980	
	C25 Suburban	1978-1977	Chrysler	Concorde	1997-1993	
	C35	1975		Intrepid	1997-1993	
	C35	1978-1977		LHS	1997-1994	
	Caballero	1978		New Yorker	1996-1994	
	G15	1975	Dodge	B1500	1998-1997	
	G15	1978-1977		B2500	1997	
	G15/G1500 Van	1974		Dakota	2000-1996	
	G25	1975		Durango	1999-1998	
	G25	1978-1977		Intrepid	1997-1993	
	G25/G2500 Van	1974		Ram 1500	2000-1997	
	G35	1975		Ram 1500 Van	2000-1999	
	G35	1978-1977				



7252 (Cont'd)	FR5-1	V-Power
Qty per Vehicle: 4-10		Box Qty: 4
Dodge	Viper	2002-1992
Eagle	Premier	1989-1988
	Vision	1997-1993
Jeep	Cherokee	2000-1986
	Comanche	1992-1986
	Grand Cherokee	1998-1993
	Wagoneer	1987-1986
	Wrangler	1995-1987
	Wrangler	2002-1997

7272	UR55IX	Iridium IX
Qty per Vehicle: 4-8		Box Qty: 4
Buick	Century	1992-1984
	Skylark	1991-1983
	Somerset	1987-1986
	Somerset Regal	1985
Chevrolet	Astro	1990-1985
	Camaro	1986-1984
	Celebrity	1990-1984
	Citation II	1985-1984
	LLV	1993-1987
	Lumina	1992-1990
	Monza	1978
	S10	1993-1985
	S10 Blazer	1988-1985
	Vega	1975
Ford	E-350 Econoline Club Wagon	1996-1992
GMC	S15	1990-1985
	S15 Jimmy	1988-1985
	Safari	1990-1985
	Sonoma	1993-1991
Oldsmobile	Calais	1987-1985
	Cutlass Calais	1991-1988
	Cutlass Ciera	1992-1984
	Cutlass Cruiser	1990-1987
	Omega	1984
	Starfire	1978
Pontiac	6000	1991-1984
	Astre	1975
	Fiero	1988-1984
	Firebird	1986-1984
	Grand Am	1991-1985
	Phoenix	1978
	Phoenix	1984
	Sunbird	1978

7274	CR6HIX	Iridium IX
Qty per Vehicle: 6		Box Qty: 4
Aston Martin	DB2	1953-1950
	DB2-4	1955-1953
	DB3	1952-1951

7293	XR45IX	Iridium IX
Qty per Vehicle: 6-8		Box Qty: 4
Buick	Apollo	1975
	Century	1977-1975
	Electra	1984-1976
	Estate Wagon	1983-1976
	LeSabre	1984-1976
	Regal	1977-1975
	Riviera	1984-1976
	Skyhawk	1976-1975
	Skylark	1977-1975
Cadillac	Eldorado	1980-1979
	Seville	1980-1976
Oldsmobile	98	1984-1973
	Custom Cruiser	1984-1973

7293 (Cont'd)	XR45IX	Iridium IX
Qty per Vehicle: 6-8		Box Qty: 4
Oldsmobile	Cutlass	1981-1975
	Cutlass Calais	1984-1978
	Cutlass Cruiser	1983-1980
	Cutlass Salon	1980-1975
	Cutlass Salon	1985
	Cutlass Supreme	1984-1975
	Cutlass Tiara	1976
	Delta 88	1984-1973
	Omega	1977-1975
	Starfire	1976-1975
	Toronado	1984-1973
	Vista Cruiser	1975

Pontiac	Bonneville	1981-1977
	Catalina	1981-1977
	Firebird	1979-1977
	Grand LeMans	1977-1976
	Grand Prix	1977
	Grand Safari	1978-1977
	Laurentian	1981
	LeMans	1977-1976
	Parisienne	1981
	Phoenix	1977
	Sunbird	1976
	Ventura	1977-1975

7300	TR4IX	Iridium IX
Qty per Vehicle: 4-6		Box Qty: 4
Buick	Century	1989-1987
	Century	1993
	Lucerne	2011-2009
	Regal	1993-1988
	Skyhawk	1989-1987
	Terraza	2007-2006
Cadillac	Cimarron	1988-1987
Chevrolet	Beretta	1993-1987
	Cavalier	1994-1987
	Celebrity	1990-1987
	Corsica	1993-1987
	Impala	2011-2006
	Lumina	1994-1990
	Malibu	2010-2006
	Monte Carlo	2007-2006
	Uplander	2009-2006
	Oldsmobile	Cutlass Ciera
Cutlass Ciera		1993
Cutlass Cruiser		1989-1987
Cutlass Supreme		1993-1988
Firenza		1988-1987
Pontiac		6000
Pontiac	G6	2010-2006
	Grand Prix	1993-1988
	Montana	2009-2006
	Sunbird	1994-1991
	Tempest	1991-1987
	Saturn	Aura
Relay		2007-2006
Vue		2010-2008

7316	TR55-1IX	Iridium IX
Qty per Vehicle: 4-8		Box Qty: 4
Buick	Century	1995-1994
Chevrolet	Beretta	1996-1994
	Cavalier	1997-1994
	Corsica	1996-1994
	LLV	1995-1994
	S10	1997-1994



7316 (Cont'd)		TR55-1IX	Iridium IX	7355 (Cont'd)		XR5IX	Iridium IX
Qty per Vehicle: 4-8			Box Qty: 4	Qty per Vehicle: 4-8			Box Qty: 4
Ford	Country Squire		1991-1987	Chevrolet	Bel Air		1970-1969
	E-150 Econoline		2002-1998		Biscayne		1970-1969
	E-150 Econoline Club Wagon		2002-1998		Brookwood		1970-1969
	E-250 Econoline		2002-1998		C10 Pickup		1968
	Escort		2002-1991		C10 Suburban		1968
	Explorer		2010-2006		C20 Pickup		1968
	Explorer Sport Trac		2010-2007		C20 Suburban		1968
	F-150		2002-1998		C30 Pickup		1968
	Focus		2004-2000		Camaro		1970-1967
	Freestar		2007-2006		Caprice		1970-1969
	LTD		1986-1985		Chevelle		1970-1969
	LTD Crown Victoria		1991-1987		Chevy II		1968-1965
	Mustang		1986-1985		Corvette		1970-1962
	Mustang		1997-1994		G10 Van		1968
	Mustang		2010-2005		G20 Van		1968
	Ranger		2011-2001		Impala		1970-1963
	Taurus		1995-1988		K10 Pickup		1968
	Thunderbird		1997-1985		K10 Suburban		1968
Windstar		1995	K20 Pickup		1968		
GMC	Sonoma		1997-1994	K20 Suburban		1968	
Isuzu	Hombre		1997-1996	K30 Pickup		1968	
Land Rover	LR3		2009-2005	Kingswood		1970-1969	
Lincoln	Continental		1994-1986	Monte Carlo		1970	
	Mark VII		1987-1985	Nova		1970	
	Town Car		1990-1986	P20 Van		1968	
Mazda	B4000		2002-2001	P30 Van		1968	
	B4000		2010-2004	Townsmen		1970-1969	
Mercury	Capri		1986-1984	Chrysler	300		1971-1959
	Colony Park		1991-1987		Cordoba		1976-1975
	Cougar		1997-1985		Newport		1966-1965
	Grand Marquis		1991-1986		New Yorker		1974-1973
	Marquis		1986-1983		Town & Country		1966-1963
	Monterey		2007-2004		Town & Country		1971-1970
	Mountaineer		2010-2007		Town & Country		1974-1973
	Sable		1995-1988		Town & Country		1977-1976
Tracer		1999-1991	Dodge	880		1965-1964	
Oldsmobile	Cutlass Ciera			1996-1994	B100 Van		1974
Pontiac	Sunfire			1997-1995	B200		1978-1975
<b>7348 UR6IX Iridium IX</b>					B200 Van		1974
Qty per Vehicle: 8				Box Qty: 4	B300		1978-1975
Ford	Mustang			1972-1970	CB300		1979-1976
	Mustang			1995	Challenger		1971-1970
<b>7355 XR5IX Iridium IX</b>					Charger		1978-1967
Qty per Vehicle: 4-8				Box Qty: 4	Coronet		1976-1965
Buick	Electra			1966-1965	D100		1978-1975
	Gran Sport			1966	D100 Pickup		1974-1973
	LeSabre			1964	D150		1978-1977
	LeSabre			1967-1966	D200		1978-1975
	Riviera			1966-1963	D200 Pickup		1974-1973
	Roadmaster		1951	D300		1978-1975	
	Skylark		1967-1964	D300 Pickup		1974-1973	
	Special		1967-1964	D400		1978	
	Sportwagon		1964	D450		1978	
	Wildcat		1966-1964	Dart		1962-1961	
	Cadillac	Calais		1966-1965	Dart		1969-1968
DeVille			1956-1953	Lancer		1961	
DeVille			1966-1958	Magnum		1978	
Eldorado			1966-1953	Monaco		1965	
Fleetwood			1966-1965	Monaco		1978-1968	
Series 60 Fleetwood			1964-1953	Polara		1962-1960	
Series 62			1964-1953	Polara		1968-1964	
Series 70 Fleetwood Eldorado			1958	Polara		1973-1972	
Series 75 Fleetwood			1964-1953	Ramcharger		1978-1974	
Checker	Marathon		1970-1968	Royal Monaco		1977-1975	
				W100		1977-1975	



7355 (Cont'd)	XR5IX	Iridium IX	
Qty per Vehicle: 4-8		Box Qty: 4	
Dodge	W100 Pickup	1974	
	W100 Series	1966-1960	
	W150	1978-1977	
	W200	1978-1975	
	W200 Pickup	1974	
	W200 Series	1966-1960	
	W300	1978-1975	
	W300 Series	1966-1960	
Excalibur	Wm300 Power Wagon	1962-1960	
	Phaeton	1970-1965	
GMC	C15/C1500 Pickup	1968	
	C15/C1500 Suburban	1968	
	C25/C2500 Pickup	1968	
	C25/C2500 Suburban	1968	
	C35/C3500 Pickup	1968	
	G15/G1500 Van	1968	
	G25/G2500 Van	1968	
	K15/K1500 Pickup	1968	
	K15/K1500 Suburban	1968	
	K25/K2500 Pickup	1968	
	K25/K2500 Suburban	1968	
	K35/K3500 Pickup	1968	
	P25/P2500 Van	1968	
P35/P3500 Van	1968		
International	100	1974	
	150	1975	
	200	1975-1974	
	908C	1969-1968	
	1000C	1968	
	1000D	1970-1969	
	1010	1973-1971	
	1100C	1968	
	1100D	1970-1969	
	1110	1973-1971	
	1200C	1968	
	1200D	1970-1969	
	1210	1973-1971	
	1300C	1968	
	1300D	1970-1969	
	1310	1973-1971	
	M800	1971-1968	
	M800 Navy	1969	
	M800 Post Office	1972-1969	
	M1100	1972-1968	
	M1200	1972-1968	
	M1400	1969	
	MA1200	1971-1968	
	MHC1310	1974	
	MS	1975	
	MS1210	1974-1972	
	M Series Van	1964-1961	
	Scout	1971-1961	
	Scout II	1980-1971	
	Travelall	1975	
	Jensen	Interceptor	1976-1970
	Oldsmobile	88	1957
		98	1969-1958
442		1969-1965	
Cutlass		1968-1964	
Cutlass Supreme		1967	
Delmont 88		1967	
Delta 88		1967-1965	
Dynamic		1966-1958	
F85		1966-1964	
Fiesta		1964-1957	

7355 (Cont'd)	XR5IX	Iridium IX	
Qty per Vehicle: 4-8		Box Qty: 4	
Oldsmobile	Jetstar 88	1966-1964	
	Jetstar I	1965-1964	
	Starfire	1957	
	Starfire	1966-1961	
	Super 88	1964-1957	
	Toronado	1967-1966	
	Vista Cruiser	1969-1964	
	Plymouth	Barracuda	1971-1967
		Belvedere	1960
		Belvedere	1965-1963
Belvedere		1970-1967	
Cuda		1971-1970	
Fury		1960	
Fury		1978-1967	
Fury I		1974-1968	
Fury II		1974-1968	
Fury III		1974-1968	
Pontiac	Gran Fury	1977-1972	
	GTX	1971-1968	
	PB200	1978-1976	
	PB300	1978-1976	
	Road Runner	1975-1968	
	Satellite	1974-1966	
	Savoy	1960	
	Sport Wagon	1960	
	Suburban	1960	
	Superbird	1970	
Pontiac	Trailduster	1978-1974	
	Bonneville	1969-1968	
	Catalina	1969-1967	
	Executive	1969-1967	
	Firebird	1969-1967	
	Grand Prix	1969-1968	
	GTO	1969-1967	
	LeMans	1969-1968	
	Tempest	1969-1968	
	<b>7373 FR5 V-Power</b>		
Qty per Vehicle: 4		Box Qty: 4	
Ford	Escort	1981	
	EXP	1982	
Mercedes-Benz	SLK230	2000-1998	
Mercury	LN7	1982	
	Lynx	1981	
<b>7390 BKR5EY V-Power</b>			
Qty per Vehicle: 6		Box Qty: 4	
Mercury	Villager	1998-1993	
Nissan	Quest	1998-1993	
<b>7397 TR5IX Iridium IX</b>			
Qty per Vehicle: 4-12		Box Qty: 4	
Aston Martin	DB7	2004	
Audi	V8 Quattro	1991-1990	
	Buick	Allure	2009-2008
		Century	1988-1986
		Electra	1987-1986
		LaCrosse	2009-2008
		LeSabre	1988-1986
		Rainier	2007-2004
		Riviera	1987-1986
		Skylark	1988-1986
		Somerset	1987-1986
Somerset Regal		1985	
Cadillac	CTS	2007-2004	
	Escalade	2000-1999	
	Escalade	2014-2002	



7397 (Cont'd)	TR5IX	Iridium IX	7397 (Cont'd)	TR5IX	Iridium IX
Qty per Vehicle: 4-12		Box Qty: 4	Qty per Vehicle: 4-12		Box Qty: 4
Cadillac	Escalade ESV	2014-2003	Ford	E-350 Econoline Club Wagon	2002-1997
	Escalade EXT	2013-2002		E-350 Super Duty	2005-1999
	SRX	2006-2004		E-450 Econoline Super Duty	2002-2000
	STS	2006-2005		Econoline Super Duty	1999
	XLR	2006-2004		Escape	2012-2009
Chevrolet	Avalanche	2013-2007		Escort	1985-1982
	Avalanche 1500	2006-2002		EXP	1985-1982
	C1500	1999-1998		F-100	1983
	C1500 Suburban	1999-1998		F-150	1995-1993
	C2500	2000-1998		F-150	1998-1997
	C2500 Suburban	1999-1998		F-150	2003-2000
	C3500	2000-1998		F-150	2010
	Camaro	2002-1998		F-150 Heritage	2004
	Camaro	2015-2010		F-250	1999-1997
	Caprice	2017-2011		Fairmont	1982-1978
	Cavalier	2002-1999		Fiesta	1980
	Colorado	2012-2009		Fusion	2012-2010
	Corvette	2013-1993		Granada	1982-1981
	Express 1500	2014-1998		LTD	1985-1983
	Express 2500	2017-1998		Mustang	1986-1979
	Express 3500	2017-1998		Mustang	1993-1991
	Express 4500	2016-2009	Mustang	2000	
	Impala	2009-2006	Mustang II	1978-1974	
	K1500	1999-1998	Pinto	1980-1974	
	K1500 Suburban	1999-1998	Probe	1992-1990	
	K2500	2000-1998	Ranger	2009-1983	
	K2500 Suburban	1999-1998	Taurus	2007-1986	
	K3500	2000-1998	Tempo	1989-1984	
	Lumina	1995-1991	Tempo	1994-1992	
	Monte Carlo	1995	Thunderbird	1988-1983	
	Monte Carlo	2007-2006	Windstar	2000-1995	
	P30	1999-1998	GMC	C1500	1999-1998
	S10	2001-1999		C1500 Suburban	1999-1998
	S10	2003		C2500	2000-1998
	Silverado 1500	2013-1999		C2500 Suburban	1999-1998
	Silverado 1500 Classic	2007		C3500	2000-1998
	Silverado 1500 HD	2003-2001		Canyon	2012-2009
	Silverado 1500 HD	2006-2005		Envoy	2009-2005
	Silverado 1500 HD Classic	2007		Envoy XL	2006-2003
	Silverado 2500	2004-1999		Envoy XUV	2005-2004
	Silverado 2500 HD	2017-2001		K1500	1999-1998
	Silverado 2500 HD Classic	2007		K1500 Suburban	1999-1998
	Silverado 3500	2006-2001		K2500	2000-1998
	Silverado 3500 Classic	2007		K2500 Suburban	1999-1998
	Silverado 3500 HD	2017-2007		K3500	2000-1998
	SS	2017-2014		P3500	1999-1998
	SSR	2006-2003		Savana 1500	2014-1998
	Suburban 1500	2014-2000		Savana 2500	2017-1998
	Suburban 2500	2013-2000		Savana 3500	2017-1998
	Suburban 3500 HD	2017-2016		Savana 4500	2016-2009
	Tahoe	2014-1998		Sierra 1500	2013-1999
	Trailblazer	2009-2006		Sierra 1500 Classic	2007
	Trailblazer EXT	2006-2003		Sierra 1500 HD	2003-2001
	Vega	1976-1975		Sierra 1500 HD	2006-2005
	DeLorean	DMC 12	Sierra 1500 HD Classic	2007	
	Dodge	Monaco	1992-1990	Sierra 2500	2004-1999
			1989-1988	Sierra 2500 HD	2017-2001
	Eagle	Medallion	1989-1988	Sierra 2500 HD Classic	2007
Premier		1992-1988	Sierra 3500	2006-2001	
Ford	Aerostar	1997-1986	Sierra 3500 Classic	2007	
	Bronco II	1990-1984	Sierra 3500 HD	2017-2007	
	Courier	1982-1977	Sonoma	2003-1998	
	E-250	2005-2003	Yukon	2014-1998	
	E-250 Econoline	2002-1997	Yukon XL 1500	2014-2000	
	E-350 Club Wagon	2005-2003	Yukon XL 2500	2013-2000	
	E-350 Econoline	1998-1997			





7397 (Cont'd)	TR5IX	Iridium IX
Qty per Vehicle: 4-12		Box Qty: 4
Hummer	H2	2009-2003
	H3	2010-2008
	H3T	2010-2009
Isuzu	Ascender	2006-2003
	Hombre	2000-1998
Jaguar	XJ12	1988-1981
	XJS	1977
	XJS	1988-1979
Lincoln	Town Car	2010-2006
Mazda	6	2008-2003
	B2300	1997-1994
	B2300	2010-2001
	B2500	2001-1998
	B3000	2003-1994
	MPV	2001-2000
	Tribute	2011-2009
	Mercedes-Benz	190E
	260E	1989-1987
	300CE	1989-1988
	300E	1993-1986
	300SE	1991-1988
	300SEL	1991-1988
	300TE	1993-1988
Mercury	Bobcat	1980-1975
	Capri	1977-1976
	Capri	1984-1979
	Cougar	1982-1981
	Cougar	1986-1984
	LN7	1983-1982
	Lynx	1982
	Lynx	1985-1984
	Mariner	2011-2009
	Marquis	1984-1983
	Milan	2011-2010
	Sable	2005-1986
	Topaz	1988-1984
	Topaz	1994-1992
	Zephyr	1982-1978
Merkur	Scorpio	1989-1988
	XR4Ti	1989-1985
Oldsmobile	98	1987-1986
	Calais	1987-1985
	Cutlass Calais	1988
	Cutlass Ciera	1988-1986
	Cutlass Cruiser	1988-1987
	Cutlass Supreme	1995-1991
	Delta 88	1988-1986
	Toronado	1987-1986
Panoz	AIV Roadster	2000-1999
	Esperante	2005-2001
Peugeot	505	1991-1987
	604	1981-1977
Pontiac	Bonneville	1988-1987
	Firebird	2002-1998
	G8	2009-2008
	Grand Am	1987-1985
	Grand Prix	1995-1991
	Grand Prix	2008-2005
	GTO	2006-2004
	Sunfire	2002-1999
Renault	Fuego	1985-1984
	R18i	1986-1984
Saab	9-7x	2009-2005
Volvo	262	1976
	262	1981-1978

7397 (Cont'd)	TR5IX	Iridium IX
Qty per Vehicle: 4-12		Box Qty: 4
Volvo	264	1982-1976
	265	1981-1976
	760	1990-1983
	780	1990-1987
<b>7401</b>	<b>UR4IX</b>	<b>Iridium IX</b>
Qty per Vehicle: 4-8		Box Qty: 4
Buick	Apollo	1974-1973
	Centurion	1973-1971
	Century	1974-1973
	Century	1981-1977
	Commercial Chassis	1991
	Electra	1974-1967
	Estate Wagon	1974-1970
	Gran Sport	1967
	GS	1972-1970
	GS 350	1969-1968
	GS 400	1969-1968
	GS 455	1972-1970
	LeSabre	1974-1968
	LeSabre	1980-1978
	LeSabre	1982
	Regal	1974-1973
	Regal	1987-1977
	Riviera	1974-1967
	Riviera	1981-1979
	Riviera	1985-1984
	Roadmaster	1991
	Skylark	1972-1967
	Skylark	1979-1977
Special	1969-1968	
Sportwagon	1972-1968	
Wildcat	1970-1967	
Cadillac	Brougham	1992-1991
	Commercial Chassis	1993
	Fleetwood	1993
Checker	Marathon	1974-1970
	Marathon	1978-1976
Chevrolet	Bel Air	1971
	Bel Air	1981
	Biscayne	1971
	Blazer	1971
	C10	1986-1976
	C10 Pickup	1971
	C10 Suburban	1971
	C10 Suburban	1986-1976
	C20	1986-1976
	C20 Pickup	1971
	C20 Suburban	1971
	C20 Suburban	1986-1976
	C30	1984-1976
	C30 Pickup	1971
	C70	1990
	Camaro	1971
	Camaro	1992-1975
Caprice	1971	
Caprice	1993-1976	
Chevelle	1971	
Corvette	1971	
Corvette	1982-1976	
Corvette	1984	
Corvette	1991-1988	
El Camino	1971-1970	
El Camino	1985-1976	
El Camino	1987	
G10	1984-1976	



7401 (Cont'd)	UR4IX	Iridium IX	7401 (Cont'd)	UR4IX	Iridium IX	
Qty per Vehicle: 4-8		Box Qty: 4	Qty per Vehicle: 4-8		Box Qty: 4	
Chevrolet	G10 Van	1971	Dodge	Mirada	1983-1980	
	G20	1984-1976		Monaco	1978-1977	
	G20 Van	1971		Ramcharger	1980-1975	
	G30	1984-1976		St. Regis	1981-1979	
	G30 Van	1971		W100	1977-1975	
	Impala	1971		W100	1987-1984	
	Impala	1985-1976		W150	1987-1978	
	K5 Blazer	1986-1976		W200	1980-1975	
	K10	1986-1976		W250	1982-1981	
	K10 Pickup	1971		W300	1978-1975	
	K10 Suburban	1971		W350	1982	
	K10 Suburban	1983-1976		Ford	Bronco	1988-1976
	K10 Suburban	1986-1985			Country Sedan	1974-1970
	K20	1985-1976			Country Squire	1974-1970
	K20 Pickup	1971			Custom	1972-1970
	K20 Suburban	1971			Custom 500	1976-1970
	K20 Suburban	1986-1976			E-100 Econoline	1983-1975
	K30	1980-1977			E-100 Econoline Club Wagon	1983-1975
	K30	1984-1982			E-150 Econoline	1988-1975
	K30 Pickup	1971			E-150 Econoline Club Wagon	1985-1975
	Kingswood	1971-1970			E-250 Econoline	1988-1975
	Laguna	1976			E-250 Econoline Club Wagon	1991-1975
	Malibu	1983-1975			E-350 Econoline	1996-1975
	Monte Carlo	1971	E-350 Econoline Club Wagon		1996-1977	
	Monte Carlo	1988-1976	Econoline Super Duty		1996	
	Monza	1979-1976	Elite		1976-1975	
	Nova	1971	F53		1996-1988	
	Nova	1979-1975	F-100		1974-1973	
	P10	1979-1977	F-100		1979-1976	
	P10 Van	1972-1971	F-100		1982-1981	
	P20	1976	F-150		1988-1975	
	P20	1984-1979	F-250		1996-1973	
	P20 Van	1972-1970	F-350		1996-1973	
P30	1976	Fairlane	1970-1969			
P30	1984-1978	Falcon	1970			
P30 Van	1972-1970	F Super Duty	1988			
Townsmen	1971-1970	F Super Duty	1996-1990			
Vega	1976	Galaxie 500	1974-1969			
Chrysler	Cordoba	1983-1980	Granada	1976-1975		
	Fifth Avenue	1983	Gran Torino	1976-1972		
	LeBaron	1981-1978	LTD	1976-1970		
	Newport	1981-1979	LTD	1986-1981		
	New Yorker	1982	LTD Crown Victoria	1991-1987		
	Town & Country	1981-1978	Maverick	1976-1975		
Dodge	Aspen	1980-1976	Mustang	1973-1969		
	B100	1980-1975	Mustang	1985-1984		
	B100 Van	1974	Mustang II	1976-1975		
	B150	1987-1981	P-350	1976		
	B200	1980-1975	P-400	1976		
	B200 Van	1974	P-500	1977-1976		
	B250	1987-1981	Ranchero	1977-1970		
	B300	1980-1975	Ranch Wagon	1974-1970		
	B300 Van	1974	Thunderbird	1973-1972		
	CB300	1975	Thunderbird	1976-1975		
	CB300	1979-1977	Torino	1976-1970		
	Charger	1976	GMC	C15	1978-1976	
	Coronet	1976-1975		C15/C1500 Pickup	1971	
	D100	1979-1975		C15/C1500 Suburban	1971	
	D100	1987-1984		C15 Suburban	1978-1976	
	D150	1987-1977		C25	1978-1976	
	D200	1980-1975		C25/C2500 Pickup	1971	
	D250	1987-1981		C25/C2500 Suburban	1971	
	D300	1978-1975		C25 Suburban	1978-1976	
	Dart	1976-1975		C35	1978-1976	
	Diplomat	1983-1978		C35/C3500 Pickup	1971	



7401 (Cont'd)	UR4IX	Iridium IX	7401 (Cont'd)	UR4IX	Iridium IX	
Qty per Vehicle: 4-8		Box Qty: 4	Qty per Vehicle: 4-8		Box Qty: 4	
GMC	C1500	1986-1979	Mercury	Marquis	1976-1971	
	C1500 Suburban	1986-1979		Marquis	1978	
	C2500	1986-1979		Monarch	1977-1975	
	C2500 Suburban	1986-1979		Montego	1976-1970	
	C3500	1980-1979		Monterey	1974-1971	
	C3500	1984-1982		Oldsmobile	Custom Cruiser	1977
	C3500	1986			Custom Cruiser	1992-1991
	Caballero	1987-1978			Cutlass	1971-1970
	G15	1978-1976			Cutlass	1976
	G15/G1500 Van	1971			Cutlass	1981-1978
	G25	1978-1976			Cutlass	1987-1985
	G25/G2500 Van	1971			Cutlass Calais	1980-1978
	G35	1978-1976			Cutlass Calais	1982
	G35/G3500 Van	1971			Cutlass Cruiser	1980
	G1500	1984-1979			Cutlass Cruiser	1982
	G2500	1984-1979			Cutlass Salon	1980-1978
	G3500	1984-1979			Cutlass Supreme	1976
	Jimmy	1971			Cutlass Supreme	1980-1978
	Jimmy	1983-1976	Cutlass Supreme		1982	
	Jimmy	1986-1985	Delta 88		1977	
	K15	1978-1976	Delta 88		1982-1981	
	K15/K1500 Pickup	1971	F85		1971-1970	
	K15/K1500 Suburban	1971	Omega		1974-1973	
	K15 Suburban	1978-1976	Omega	1979-1976		
	K25	1978-1976	Starfire	1979-1977		
	K25/K2500 Pickup	1971	Plymouth	Caravelle	1983-1978	
	K25/K2500 Suburban	1971		Duster	1976-1974	
	K25 Suburban	1978-1976		Fury	1978-1975	
	K35	1978-1977		Gran Fury	1983-1980	
	K35/K3500 Pickup	1971		PB100	1980-1975	
	K1500	1986-1979		PB100 Van	1974	
	K1500 Suburban	1984-1979		PB150	1983-1981	
	K2500	1985-1979		PB200	1978-1975	
	K2500 Suburban	1984-1979		PB200	1980	
	K3500	1984-1979		PB200 Van	1974	
	P15/P1500 Van	1971		PB250	1983-1981	
	P25	1976		Scamp	1976-1975	
	P25/P2500 Van	1971-1970		Trailduster	1980-1975	
	P35	1976		Valiant	1976-1975	
	P35	1978		Volare	1980-1976	
	P35/P3500 Van	1971-1970		Pontiac	Bonneville	1974-1972
	P1500	1979			Bonneville	1986-1983
	P2500	1984-1979			Catalina	1974-1972
	P3500	1984-1979	Catalina		1981-1977	
	Sprint	1971	Firebird		1974-1970	
Sprint	1977-1975	Firebird	1985-1976			
Jeep	J-100	1971-1969	Firebird		1992-1987	
	J-2500	1971-1969	Grand Am		1974-1973	
	J-2600	1970-1969	Grand Am		1980-1978	
	J-2700	1970-1969	Grand LeMans		1982-1976	
	J-3500	1970-1969	Grand Prix		1974-1972	
	J-3600	1970-1969	Grand Prix		1987-1978	
	J-3700	1970-1969	Grand Safari		1974-1972	
	J-3800	1970-1969	Grandville		1974-1972	
	Wagoneer	1971	GTO		1973-1972	
	Lincoln	Continental	1976-1973		Laurentian	1981-1976
Mark IV		1976-1973	LeMans		1974-1970	
Mercury	Capri	1985-1984	LeMans		1981-1976	
	Colony Park	1974-1970	Parisienne	1986-1976		
	Comet	1976-1971	Phoenix	1979-1977		
	Cougar	1978-1969	Sunbird	1979-1978		
	Cyclone	1971-1969	Tempest	1970		
	Grand Marquis	1976-1975	Ventura	1974-1971		
	Grand Marquis	1978	Ventura	1977-1976		
	Grand Marquis	1989-1983				



7415		DCPR8EKP	Laser Platinum	7510 (Cont'd)		WR5IX	Iridium IX	
Qty per Vehicle: 6			Box Qty: 4	Qty per Vehicle: 4-8			Box Qty: 4	
BMW	M3		2006-2001	Ford	M-450		1974	
	Z3		2002-2001		Mainline		1956-1955	
	Z4		2008-2006		Maverick		1977-1970	
<b>7418</b>		<b>IFR5J11</b>	<b>Laser Iridium</b>		Mustang		1973-1964	
Qty per Vehicle: 4-6			Box Qty: 4		Mustang		1982-1979	
Chevrolet	Tracker		2004-2001		P-100		1966-1965	
Suzuki	Aerio		2007-2002		P-350		1976-1965	
	Grand Vitara		2005-2000		P-400		1976-1975	
	SX4		2009-2007		P-500		1977-1975	
	Vitara		2004-2000		Park Lane Wagon		1956	
XL-7		2003-2002	Pinto			1974-1971		
<b>7505</b>		<b>SILFR6C11</b>	<b>Laser Iridium</b>		Ranchero		1974-1957	
Qty per Vehicle: 6			Box Qty: 4		Ranch Wagon		1974-1955	
Subaru	Legacy		2017-2010		Skyliner		1959-1955	
	Outback		2017-2010		Sprint		1964-1963	
	Tribeca		2014-2010		Starliner		1960	
<b>7510</b>		<b>WR5IX</b>	<b>Iridium IX</b>		Sunliner		1960-1955	
Qty per Vehicle: 4-8			Box Qty: 4		Thunderbird		1973-1955	
Dodge	Ram 3500		1995-1994		Thunderbird		1982-1980	
Ford	Bronco		1974-1966		Torino		1974-1968	
	Bronco		1986-1980		Victoria		1960-1955	
	Club		1959-1955		Lincoln	Capri		1959-1952
	Club Wagon		1965-1962		Continental		1972-1958	
	Club Wagon		1967		Cosmopolitan		1954-1952	
	Country Sedan		1974-1955		Custom		1955	
	Country Squire		1974-1955		Lincoln Series		1960	
	Courier Sedan Delivery		1960-1955		Mark II		1957-1956	
	Custom		1957		Mark III		1971-1968	
	Custom		1972-1964		Mark IV		1972	
	Custom 300		1960-1958		Premier		1960-1956	
	Custom 500		1974-1964		Mercury	Brougham		1967
	Customline		1956-1955		Caliente		1967-1964	
	Del Rio Wagon		1958-1957		Capri		1967-1966	
	E-100 Econoline		1983-1969		Capri		1974-1971	
	E-100 Econoline Club Wagon		1983-1975		Capri		1982-1979	
	E-150 Econoline		1986-1975		Colony Park		1973-1957	
	E-150 Econoline Club Wagon		1986-1975		Comet		1969-1960	
	E-200 Econoline		1974-1969		Comet		1977-1971	
	E-250 Econoline		1986-1975	Commuter		1962-1957		
	E-250 Econoline Club Wagon		1980-1977	Commuter		1968-1964		
	E-250 Econoline Club Wagon		1986-1983	Cougar		1970-1967		
	E-300 Econoline		1974-1969	Cougar		1974		
	E-350 Econoline		1986-1975	Cougar		1982-1980		
	E-350 Econoline Club Wagon		1986-1977	Country Cruiser		1960-1959		
	Econoline		1967-1961	Country Cruiser		1963		
	F-100		1983-1961	Custom		1956-1955		
	F-150		1986-1975	Cyclone		1971-1964		
	F-250		1986-1961	Marauder		1967-1963		
	F-350		1986-1961	Marauder		1970-1969		
	F-500		1977-1975	Marquis		1973-1967		
	Fairlane		1970-1955	Marquis		1983		
	Fairmont		1983-1978	Medalist		1956		
	Falcon		1970-1960	Medalist		1958		
	Falcon Sedan Delivery		1965-1961	Meteor		1963-1961		
	Ford 300		1963	Monarch		1980-1975		
	F Series		1959-1957	Montclair		1960-1955		
	Galaxie		1967-1959	Montclair		1968-1964		
	Galaxie 500		1974-1968	Montego		1974-1968		
	Granada		1982-1975	Monterey		1973-1955		
	Gran Torino		1974-1972	Park Lane		1959-1958		
	LTD		1974-1965	Park Lane		1968-1964		
	LTD		1983	Turnpike Cruiser		1957		
	M-400		1971	Villager		1967-1962		
	M-400		1973	Voyager		1959-1957		
				Voyager		1967-1966		



7510 (Cont'd)	WR5IX	Iridium IX
Qty per Vehicle: 4-8		Box Qty: 4
Mercury	Zephyr	1983-1978
7516	YR5IX	Iridium IX
Qty per Vehicle: 6-8		Box Qty: 4
Buick	Apollo	1974-1973
Chevrolet	Bel Air	1970
	Bel Air	1974-1972
	Biscayne	1970
	Biscayne	1972
	Blazer	1974-1970
	Brookwood	1972
	C10	1980-1975
	C10	1983-1982
	C10	1986-1985
	C10 Pickup	1974-1970
	C10 Suburban	1981-1970
	C10 Suburban	1986-1985
	C20	1986-1975
	C20 Pickup	1974-1970
	C20 Suburban	1986-1970
	C30	1986-1975
	C30 Pickup	1974-1970
	C50	1990-1986
	C70	1990-1986
	Camaro	1970
	Camaro	1974-1972
	Caprice	1970
	Caprice	1974-1972
	Chevelle	1973-1970
	Corvette	1970
	Corvette	1974-1972
	El Camino	1974-1969
	El Camino	1979-1976
	G10	1983-1975
	G10 Van	1970
	G10 Van	1974-1972
	G20	1986-1975
	G20 Van	1974-1970
	G30	1988-1975
	G30 Van	1974-1971
	Impala	1970
	Impala	1974-1972
	K5 Blazer	1981-1975
	K10	1986-1975
	K10 Pickup	1974-1970
	K10 Suburban	1983-1970
	K10 Suburban	1986-1985
	K20	1986-1975
	K20 Pickup	1974-1970
	K20 Suburban	1986-1970
	K30	1986-1977
	K30 Pickup	1974-1970
	Kingswood	1972
	Laguna	1975-1973
	Malibu	1974-1973
Monte Carlo	1974-1970	
Nova	1970	
Nova	1974-1972	
P10	1980-1975	
P10 Van	1970	
P10 Van	1974-1972	
P20	1989-1975	
P20 Van	1974-1970	
P30	1989-1975	
P30 Van	1974-1970	
R20	1988-1987	

7516 (Cont'd)	YR5IX	Iridium IX	
Qty per Vehicle: 6-8		Box Qty: 4	
Chevrolet	R30	1988-1987	
	R3500	1989	
	Townsmen	1970	
	Townsmen	1972	
	V20	1987	
	V30	1988-1987	
	V3500	1989	
	GMC	C15	1978-1975
		C15/C1500 Pickup	1974-1970
		C15/C1500 Suburban	1974-1970
C15 Suburban		1978-1975	
C25		1978-1975	
C25/C2500 Pickup		1974-1970	
C25/C2500 Suburban		1974-1970	
C25 Suburban		1978-1975	
C35		1978-1975	
C35/C3500 Pickup		1974-1970	
C1500		1983-1979	
C1500		1986-1985	
C1500 Suburban		1983-1979	
C1500 Suburban		1986-1985	
C2500		1986-1979	
C2500 Suburban		1986-1979	
C3500		1986-1979	
Caballero		1979-1978	
G15		1978-1975	
G15/G1500 Van		1974-1970	
G25		1978-1975	
G25/G2500 Van		1974-1970	
G35		1978-1975	
G35/G3500 Van		1974-1971	
G1500		1983-1979	
G2500		1983-1979	
G2500		1986-1985	
G3500		1988-1979	
Jimmy		1981-1970	
K15		1978-1975	
K15/K1500 Pickup		1974-1970	
K15/K1500 Suburban		1974-1970	
K15 Suburban		1978-1975	
K25		1978-1975	
K25/K2500 Pickup		1974-1970	
K25/K2500 Suburban		1974-1970	
K25 Suburban		1978-1975	
K35		1978-1977	
K35/K3500 Pickup		1974-1970	
K1500		1985-1979	
K1500 Suburban		1984-1979	
K2500		1986-1979	
K2500 Suburban		1986-1979	
K3500		1986-1979	
P15		1978-1975	
P15/P1500 Van	1970		
P15/P1500 Van	1974-1972		
P25	1978-1975		
P25/P2500 Van	1974-1970		
P35	1978-1975		
P35/P3500 Van	1974-1970		
P1500	1980-1979		
P2500	1987-1979		
P2500	1989		
P3500	1989-1979		
R2500	1988-1987		
R3500	1989-1987		
Sprint	1977-1972		





7516 (Cont'd)	YR5IX	Iridium IX
Qty per Vehicle: 6-8		Box Qty: 4
GMC	V2500	1987
	V3500	1989-1987
Pontiac	Ventura	1972
7517	BUR6ET	Standard
Qty per Vehicle: 4		Box Qty: 4
Audi	80	1990-1988
	90	1988
Volkswagen	Golf	1998-1993
	Jetta	1995-1993
7558	ZFR5F	V-Power
Qty per Vehicle: 4-12		Box Qty: 4
BMW	750iL	1996-1988
	850Ci	1997-1993
	850CSi	1995-1994
	850i	1992-1991
Mazda	626	2002-1998
	Millenia	2002-1995
Saturn	Astra	2009-2008
7559	UR45IX	Iridium IX
Qty per Vehicle: 4-8		Box Qty: 4
American Motors	Concord	1982-1980
	Eagle	1983-1981
	Spirit	1982-1980
Buick	Apollo	1975
	Century	1985-1975
	Electra	1975
	Electra	1985-1977
	Estate Wagon	1975
	Estate Wagon	1980-1978
	LeSabre	1985-1975
	Regal	1987-1975
	Riviera	1975
	Riviera	1978-1977
	Riviera	1984-1981
	Skyhawk	1980-1977
	Skylark	1982-1975
Cadillac	DeVille	1982-1980
	Eldorado	1982-1981
	Fleetwood	1982-1980
	Seville	1982-1981
Checker	Marathon	1975
	Marathon	1977
	Marathon	1982-1979
Chevrolet	Brookwood	1971
	Camaro	1983-1980
	Caprice	1985-1980
	Celebrity	1983-1982
	Citation	1983-1980
	El Camino	1984-1978
	Impala	1985-1980
	Malibu	1983-1978
	Monte Carlo	1987-1978
	Monza	1975
	Monza	1980-1978
	Nova	1970
	Excalibur	Phaeton
Ford	Bronco	1996-1989
	Custom 500	1977
	E-150 Econoline	1996-1989
	E-150 Econoline Club Wagon	1996-1986
	E-250 Econoline	1991-1989
	F-150	1996-1989
	F-250	1996-1989
	Fairmont	1982-1978

7559 (Cont'd)	UR45IX	Iridium IX
Qty per Vehicle: 4-8		Box Qty: 4
Ford	Granada	1981-1977
	LTD	1985-1977
	LTD II	1979-1977
	Maverick	1977
	Mustang	1982-1979
	Mustang	1985-1984
	Mustang	1995-1987
	Mustang II	1978-1977
	P-400	1976
	P-500	1977-1976
	Ranchero	1979-1975
	Thunderbird	1974
	Thunderbird	1982-1977
	Thunderbird	1985-1984
	Thunderbird	1993-1991
	GMC	Caballero
Jeep	CJ5	1983-1980
	CJ7	1983-1980
	Scrambler	1983-1981
Lincoln	Continental	1974
	Continental	1980-1977
	Continental	1985-1982
	Mark IV	1974
	Mark V	1979-1977
	Mark VI	1983-1980
	Mark VII	1985-1984
	Mark VII	1992-1987
	Town Car	1985-1981
	Versailles	1980-1977
Mercury	Capri	1983-1979
	Colony Park	1974
	Comet	1977
	Cougar	1974
	Cougar	1985-1977
	Cougar	1993-1991
	Grand Marquis	1985-1977
	Marquis	1974
	Marquis	1982-1977
	Monarch	1980-1977
	Montego	1974
Monterey	1974	
Zephyr	1982-1978	
Oldsmobile	98	1975
	98	1983-1981
	98	1985
	Custom Cruiser	1975
	Cutlass	1981-1977
	Cutlass Calais	1984-1978
	Cutlass Ciera	1985-1982
	Cutlass Cruiser	1983-1980
	Cutlass Salon	1980-1978
	Cutlass Salon	1987-1985
	Cutlass Supreme	1987-1977
	Delta 88	1975
	Delta 88	1985-1977
	Omega	1975
	Omega	1983-1977
Starfire	1980-1977	
Toronado	1984-1981	
Pontiac	6000	1983-1982
	Astre	1977
	Bonneville	1986-1975
	Catalina	1981-1975
	Firebird	1983-1975
	Grand Am	1975



7559 (Cont'd)	UR45IX	Iridium IX
Qty per Vehicle: 4-8		Box Qty: 4
Pontiac	Grand Am	1980-1978
	Grand LeMans	1983-1975
	Grand Prix	1987-1975
	Grand Safari	1978-1975
	Grandville	1975
	Laurentian	1977-1976
	Laurentian	1981-1980
	LeMans	1981-1975
	Parisienne	1977-1976
	Parisienne	1985-1980
	Phoenix	1983-1977
	Sunbird	1980-1977
Ventura	1977-1975	

7563	IZKR7B	Laser Iridium
Qty per Vehicle: 4-6		Box Qty: 4
Audi	A3 Quattro	2009-2006
	TT	2003
	TT Quattro	2006-2004
	TT Quattro	2009-2008
Porsche	Cayenne	2006-2004
Volkswagen	Eos	2008-2007
	Golf	2004
	R32	2008
	Touareg	2006-2004

7588	YR55IX	Iridium IX
Qty per Vehicle: 6-8		Box Qty: 4
Buick	Apollo	1975
Chevrolet	Bel Air	1975
	C10	1975
	C10	1978-1977
	C10 Suburban	1975
	C10 Suburban	1978-1977
	C20	1975
	C20	1978-1977
	C20 Suburban	1975
	C20 Suburban	1978-1977
	C30	1975
	C30	1978-1977
	Camaro	1975
	Caprice	1975
	Corvette	1975
	El Camino	1975
	El Camino	1978
	G10	1978-1975
	G10 Van	1974
	G20	1978-1975
	G20 Van	1974
	G30	1978-1975
	G30 Van	1974
	Impala	1975
	K5 Blazer	1975
	K5 Blazer	1978-1977
	K10	1975
	K10	1978-1977
	K10 Suburban	1975
	K10 Suburban	1978-1977
	K20	1975
	K20	1978-1977
	K20 Suburban	1975
	K20 Suburban	1978-1977
K30	1978-1977	
Laguna	1975	
Malibu	1975	
Monte Carlo	1975	

7588 (Cont'd)	YR55IX	Iridium IX	
Qty per Vehicle: 6-8		Box Qty: 4	
Chevrolet	Monza	1975	
	Nova	1975	
	P10	1975	
	P10	1977	
	P20	1975	
	P20	1978-1977	
	P30	1975	
	P30	1978-1977	
	GMC	C15	1975
		C15	1978-1977
		C15 Suburban	1975
		C15 Suburban	1978-1977
C25		1975	
C25		1978-1977	
C25 Suburban		1975	
C25 Suburban		1978-1977	
C35		1975	
C35		1978-1977	
Caballero		1978	
G15		1975	
G15		1978-1977	
G15/G1500 Van		1974	
G25		1975	
G25		1978-1977	
G25/G2500 Van		1974	
G35		1975	
G35		1978-1977	
G35/G3500 Van		1974	
Jimmy		1975	
Jimmy		1978-1977	
K15		1975	
K15		1978-1977	
K15 Suburban		1975	
K15 Suburban		1977	
K25		1975	
K25	1978-1977		
K25 Suburban	1975		
K25 Suburban	1978-1977		
K35	1978-1977		
P15	1975		
P25	1975		
P25	1978-1977		
P35	1975		
P35	1978-1977		
Sprint	1977-1975		
Oldsmobile	Cutlass	1975	
	Cutlass Supreme	1975	
	Omega	1975	
Pontiac	Firebird	1975	
	Grand LeMans	1975	
	LeMans	1975	
	Ventura	1975	

7634	BPR5ES-11	Standard
Qty per Vehicle: 3-6		Box Qty: 4
Chevrolet	Nova	1988-1985
	Sprint	1992-1989
Chrysler	Daytona	1993-1990
	Dynasty	1990-1988
	E Class	1984-1983
	Executive Limousine	1985
	Executive Sedan	1984-1983
	Grand Voyager	2000
	LeBaron	1985-1982
	LeBaron	1995-1990
	New Yorker	1985-1983



7634 (Cont'd)		BPR5ES-11	Standard	7634 (Cont'd)		BPR5ES-11	Standard	
Qty per Vehicle: 3-6			Box Qty: 4	Qty per Vehicle: 3-6			Box Qty: 4	
Chrysler	New Yorker		1989-1988	Plymouth	Arrow		1980-1979	
	TC Maserati		1991-1990		Arrow Pickup		1982-1979	
	Town & Country		1982		Caravelle		1985-1983	
	Town & Country		1985-1984		Colt		1980-1978	
Voyager		2000	Colt			1992-1991		
Daihatsu	Charade		1992-1988		Grand Voyager		1989-1987	
Dodge	400		1983-1982		Grand Voyager		2000-1992	
	600		1985-1983		Reliant		1985-1981	
	Aries		1985-1981		Sapporo		1983-1978	
	Caravan		2000-1984		Sundance		1994-1992	
	Challenger		1983-1978		Voyager		2000-1984	
	Colt		1980-1978		Toyota	Camry		1986-1983
	Colt		1995-1991			Celica		1986-1982
	D50		1982-1979			Corolla		1988-1980
	Daytona		1993-1990			Cressida		1988-1982
	Dynasty		1993-1988			Land Cruiser		1978-1975
	Grand Caravan		1989-1987	Land Cruiser			1992-1990	
	Grand Caravan		2000-1992	Starlet			1984-1983	
	Mini Ram		1988-1987	Tercel			1994-1981	
	Power Ram 50		1983	Van			1989-1984	
	Raider		1989	<b>7654 PLFR6A-11 Laser Platinum</b>				
	Ram 50		1983	Qty per Vehicle: 6-8			Box Qty: 4	
	Ram 50		1991-1990	Lexus		GX460		2017-2016
	Shadow		1994-1992			LX570		2017-2015
	Spirit		1995-1989	Subaru		Outback		2004-2001
	Stealth		1996-1991			Toyota	4Runner	
Eagle	Summit		1996-1989	FJ Cruiser				2009-2007
	Vista		1992-1988	Land Cruiser			2017-2015	
Honda	Accord		1989-1986	Sequoia			2016-2015	
	Civic		1973	Tacoma			2011-2005	
	Passport		1996-1994	Tundra			2010-2005	
Hyundai	Prelude		1987-1985	Tundra			2017-2013	
	Santa Fe		2006-2001	<b>7658 IFR6J11 Laser Iridium</b>				
Isuzu	Sonata		2005-1990	Qty per Vehicle: 4-6			Box Qty: 4	
	Amigo		1994-1989	Suzuki	Esteem		2002-2001	
	Pickup		1995-1992		Grand Vitara		2008-2006	
	Rodeo		1997-1991		XL-7		2006-2004	
Trooper			1991-1988	<b>7734 BPR5ES Standard</b>				
	Qty per Vehicle: 3-12			Box Qty: 4				
	Kia	Magentis		2006-2001	Aston Martin	Lagonda		1989-1979
Optima			2006-2001	V-8			1989-1979	
Sephia			1995-1994	Virage			1989	
				Zagato			1988-1987	
Mazda	323		1995-1986	Asuna	Sunrunner		1992	
	B2200		1993-1990	Audi	4000		1980	
	B2600		1988-1987		Fox		1979-1973	
Mitsubishi	3000GT		1999-1997	BMW	2.8 Bavaria		1971	
	Galant		1988-1985		3.0CS		1974-1971	
	Mighty Max		1985-1983		3.0CSi		1974-1971	
	Mighty Max		1994-1990		3.0CSL		1971	
	Mirage		1999-1991		3.0S		1974-1971	
	Montero		1985-1983		3.0Si		1971	
	Montero		1994-1989		3.0Si		1976-1975	
	Sigma		1990-1989	318i		1985-1984		
Nissan	210		1982-1979	320i		1983-1977		
	280Z		1978-1977	528i		1981-1979		
	280ZX		1980-1979	530i		1978-1975		
	310		1982-1979	533i		1984-1983		
	810		1979-1977	535i		1988-1985		
	B210		1978-1977	535is		1988		
	F10		1978-1977	630CSi		1978-1977		
	Micra		1991-1984	633CSi		1984-1978		
	Pulsar		1983	635CSi		1987-1985		
	Pulsar NX		1988-1983	733i		1984-1978		
	Sentra		1986-1982					
	Stanza		1983-1982					
Plymouth	Acclaim		1995-1989					



7734 (Cont'd)	BPR5ES	Standard
Qty per Vehicle: 3-12		Box Qty: 4
BMW	735i	1987-1985
	2500	1971-1968
	2800	1974-1968
	Bavaria	1974-1972
	L6	1987
Chrysler	Daytona	1987
Citroen	SM	1975-1973
Dodge	Colt	1975-1974
Geo	Tracker	1995-1989
Jaguar	3.8	1966-1960
	420	1967
	Mark X	1966-1962
	Vanden Plas	1987-1982
	XJ	1971-1969
	XJ6	1987-1972
	XJS	1978
	XK150	1961-1958
	XKE	1971-1961
Land Rover	Defender 90	1995-1994
	Defender 90	1997
	Defender 110	1993
	Range Rover	2002-1987
Lotus	Elite	1979-1976
	Esprit	1982-1980
Mazda	626	1987-1979
	B2000	1984-1979
	B2000	1987-1986
	B2200	1993-1987
	GLC	1985-1979
Mercedes-Benz	230	1978-1974
	280	1976-1975
	280C	1976-1975
	280CE	1981-1978
	280E	1981-1977
	280S	1976-1975
	280SE	1980-1977
	380SE	1985-1984
	380SEC	1983-1982
	380SEL	1983-1981
	380SL	1985-1981
	380SLC	1981
	420SEL	1991-1986
	450SE	1976-1973
	450SEL	1980-1973
	450SL	1980-1973
	450SLC	1980-1973
	500SEC	1985-1984
	500SEL	1985-1984
	560SEC	1991-1986
	560SEL	1991-1986
	560SL	1989-1986
	MG	Midget
Midget		1979-1975
Nissan	200SX	1983-1982
	720	1986-1981
	1200	1973-1971
	2000	1970-1968
	B210	1976-1975
	D21	1989-1986
	F10	1976
	Pathfinder	1988-1987
	Van	1988-1987
	Plymouth	Grand Voyager
Voyager		1998-1997
Pontiac	Sunrunner	1994

7734 (Cont'd)	BPR5ES	Standard	
Qty per Vehicle: 3-12		Box Qty: 4	
Porsche	911	1979-1978	
	928	1982-1978	
	944	1984-1983	
Renault	Alliance	1987-1983	
	Encore	1986-1984	
	LeCar	1985-1980	
Rolls-Royce	Corniche	1985-1984	
	Corniche II	1992-1986	
	Silver Spirit	1991-1987	
	Silver Spur	1991-1987	
Suzuki	LJ81	1981	
	Samurai	1995-1985	
	Sidekick	1994-1989	
	SJ410	1985-1980	
	SJ413	1985	
	Toyota	4Runner	1995-1984
Toyota	Carina	1973-1972	
	Celica	1986-1973	
	Corolla	1979-1968	
	Corona	1982-1972	
	Cressida	1981-1978	
	Crown	1972-1967	
	Land Cruiser	1974-1967	
	Land Cruiser	1989-1979	
	Mark II	1976-1972	
	Pickup	1995-1970	
	Starlet	1982-1981	
	Van Wagon	1988	
	Triumph	GT6	1973-1967
		Spitfire	1980-1963
Stag		1973-1971	
TR7		1982-1975	
Triumph	TR8	1982-1980	
	Volkswagen	Dasher	1980-1974
		Rabbit	1980-1975
		Rabbit Convertible	1980
		Rabbit Pickup	1980
Scirocco		1980-1975	
Volvo	760	1986-1984	
	760	1990-1988	
	DL	1984	
	GLE	1984	
Yugo	Cabrio	1992-1990	
	GV	1992-1986	
	GVL	1989-1988	
	GVS	1988	
	GVX	1989-1988	
7740	PTR5C-13	Laser Platinum	
Qty per Vehicle: 4-10		Box Qty: 4	
Buick	Lucerne	2011-2006	
Cadillac	DTS	2011-2006	
	SRX	2009-2007	
	STS	2010-2007	
	XLR	2009-2007	
Ford	Aerostar	1997-1990	
	Contour	2000-1995	
	Crown Victoria	2011-1992	
	E-150	2014-2003	
	E-150 Club Wagon	2005-2003	
	E-150 Econoline	2002-1997	
	E-150 Econoline Club Wagon	2002-1997	
	E-250	2014-2003	
	E-250 Econoline	2002-1997	
	E-350 Club Wagon	2005-2003	
E-350 Econoline	1998-1997		



7740 (Cont'd)	PTR5C-13	Laser Platinum	7740 (Cont'd)	PTR5C-13	Laser Platinum		
Qty per Vehicle: 4-10		Box Qty: 4	Qty per Vehicle: 4-10		Box Qty: 4		
Ford	E-350 Econoline Club Wagon	2002-1997	Mercury	Topaz	1994-1989		
	E-350 Super Duty	2017-1999	Oldsmobile	Aurora	2002-2001		
	E-450 Econoline Super Duty	2002-1999		Intrigue	2002-1999		
	E-450 Super Duty	2017-2003	Pontiac	Bonneville	2005-2004		
	E-550 Econoline Super Duty	2002	<b>7743 PZFR5J-11 Laser Platinum</b>				
	E-550 Super Duty	2003	Qty per Vehicle: 12		Box Qty: 4		
	Econoline Super Duty	1999-1997	Volkswagen	Phaeton	2006		
	Escape	2008-2001	<b>7746 IFR7G-11KS Laser Iridium</b>				
	Excursion	2005-2000	Qty per Vehicle: 4		Box Qty: 4		
	Expedition	2004-1997	Acura	CSX	2010-2007		
	Explorer	2005-1991		RSX	2006-2002		
	Explorer Sport	2003-2001	Honda	Civic	2011-2006		
	Explorer Sport Trac	2005-2001		S2000	2009-2000		
	F53	2004-1999	<b>7751 ILZKR7B11 Laser Iridium</b>				
	F-150	2009-1997	Qty per Vehicle: 6		Box Qty: 4		
	F-150 Heritage	2004	Acura	RDX	2018-2013		
	F-250	1999-1997		TL	2012-2009		
	F-250 Super Duty	2004-1999		TSX	2014-2010		
	F-350 Super Duty	2004-1999	Honda	Accord	2017-2008		
	F-450 Super Duty	2004-1999		Accord Crosstour	2011-2010		
	F-550 Super Duty	2004-1999		Crosstour	2015-2012		
	Fiesta	1979-1978		Odyssey	2010-2008		
	Five Hundred	2007-2005		Pilot	2011-2009		
	Focus	2011		Ridgeline	2014-2009		
	Freestar	2005-2004	<b>7755 BKR4ESA-11 Standard</b>				
	Freestyle	2007-2005	Qty per Vehicle: 4-8		Box Qty: 4		
	Fusion	2009-2006	Rolls-Royce	Corniche IV	1995-1993		
	Mustang	2004-1993		Corniche S	1995		
	Ranger	1996-1990		Flying Spur	1995		
	Ranger	2008		Silver Spirit	1995-1992		
	Ranger	2011-2010		Silver Spur	1998-1992		
	Taurus	2005-1996		Touring Limousine	1994		
	Tempo	1994-1989	Saturn	SC1	2002-1993		
	Thunderbird	1997-1994		SL	2002-1991		
	Transit Connect	2013-2010		SL1	2002-1991		
	Windstar	2003-1996		SW1	1999-1993		
	Lincoln	Aviator	2005-2003	<b>7772 PFR7G-11S Laser Platinum</b>			
		Blackwood	2002	Qty per Vehicle: 4		Box Qty: 4	
		Continental	2002-1995	Acura	CSX	2010-2007	
		LS	2005-2000		RSX	2006-2002	
		Mark VIII	1998-1993	Honda	Civic	2011-2006	
		Navigator	2004-1998		S2000	2009-2000	
		Town Car	2008-1991		<b>7773 UR6 V-Power</b>		
		Town Car	2011	Qty per Vehicle: 8		Box Qty: 4	
		Zephyr	2006	Ford	Mustang	1972-1970	
		Mustang	1995				
Mazda	5	2007-2006	<b>7781 ZFR5LP-13G Laser Platinum</b>				
	6	2005-2003	Qty per Vehicle: 6		Box Qty: 4		
	B3000	2002-1994	Chrysler	300	2010-2005		
	B3000	2008-2004		300M	2004-1999		
	B4000	1996-1994		Concorde	2004-1998		
	B4000	2003		Intrepid	2004-1998		
	MPV	2006-2000		LHS	2001-1999		
	Navajo	1994-1991		Pacifica	2008-2004		
	Tribute	2006-2001		Prowler	2002-2001		
	Tribute	2008		Sebring	2010-2007		
				Town & Country	2010-2008		
	Mercury	Cougar		1997-1994	Dodge	Avenger	2010-2008
		Cougar		2002-1999		Challenger	2010-2009
Grand Marquis		2011-1992		Charger		2010-2006	
Marauder		2003	Grand Caravan	2010-2008			
Mariner		2008-2005	Intrepid	2004-1998			
Milan		2009-2006	Journey	2010-2009			
Montego		2007-2005					
Mountaineer		2006-1997					
Mystique		2000-1995					
Sable	2005-1996						





7781 (Cont'd)		ZFR5LP-13G	Laser Platinum
Qty per Vehicle: 6			Box Qty: 4
Dodge	Magnum		2008-2005
	Nitro		2011-2007
Plymouth	Prowler		1997
	Prowler		2001-1999
Volkswagen	Routan		2010-2009
7787		LFR6C-11	V-Power
Qty per Vehicle: 4-8			Box Qty: 4
BMW	128i		2009-2008
	323i		2009-2006
	325i		2006
	325xi		2006
	328i		2009-2007
	328i xDrive		2009
	328xi		2008-2007
	330i		2006
	330xi		2006
	525i		2007-2006
	525xi		2007-2006
	528i		2010-2008
	528i xDrive		2010-2009
	528xi		2008
	530i		2007-2006
	530xi		2007-2006
	X3		2009-2007
X5		2009-2007	
Z4		2009-2006	
Honda	Civic		2011-2006
Lexus	GX460		2017-2010
	LX570		2011-2008
	LX570		2017-2013
Saab	9-3		2009-2006
Subaru	Legacy		2017-2010
	Outback		2017-2010
	Tribeca		2014-2010
Suzuki	Grand Vitara		2012-2009
Toyota	Kizashi		2012-2010
	4Runner		2013-2003
	FJ Cruiser		2013-2007
	Land Cruiser		2011-2008
	Land Cruiser		2017-2013
	Sequoia		2016-2008
Tacoma		2015-2005	
Tundra		2017-2005	
7790		PZFR6E-11	Laser Platinum
Qty per Vehicle: 6			Box Qty: 4
Acura	CL		2003-2001
	TL		2003-2002
7797		BKR5EK	Standard
Qty per Vehicle: 6			Box Qty: 4
Cadillac	Catera		2001-1997
Saturn	L300		2005-2001
	LS2		2000
	LW2		2000
	LW300		2003-2001
	Vue		2003-2002
7808		BKUR6ET	Standard
Qty per Vehicle: 4-6			Box Qty: 4
Audi	A4		1996
	A4		1999
	A4 Quattro		1996
	A4 Quattro		2000-1999
	A6 Quattro		1996-1995
	Cabriolet		1996-1995
Volkswagen	Passat		1998

7808 (Cont'd)		BKUR6ET	Standard
Qty per Vehicle: 4-6			Box Qty: 4
Volkswagen	Passat		2000
7839		DR7EA	Standard
Qty per Vehicle: 4-6			Box Qty: 10
BMW	M3		1991-1988
	M5		1988
	M6		1988-1987
7854		IFR5G11	Laser Iridium
Qty per Vehicle: 4-6			Box Qty: 4
Hyundai	Azera		2011-2006
	Elantra		2003
	Entourage		2010-2007
	Santa Fe		2009-2007
	Sonata		2010-2006
	Tiburon		2008
	Tucson		2009-2005
	Veracruz		2012-2007
	Kia	Amanti	
Sedona			2012-2006
Sedona			2014
Sorento			2009-2007
Sportage			2010-2005
7862		PZTR5A-15	Laser Platinum
Qty per Vehicle: 4-8			Box Qty: 4
Buick	Century		1993-1989
	Commercial Chassis		1996-1994
	Skylark		1993-1989
	Skylark		1998-1996
Cadillac	60 Special		1993
	Allante		1993-1987
	Commercial Chassis		1996-1985
	DeVille		1995-1982
	Eldorado		1993-1982
	Fleetwood		1992-1982
	Seville		1993-1982
Chevrolet	Avalanche 2500		2006-2002
	Blazer		1997-1996
	C1500		1997-1996
	C3500		1996
	C3500HD		2002-2001
	C4500 Kodiak		2009-2008
	C5500 Kodiak		2009-2008
	C6500 Kodiak		2009-2008
	C7500 Kodiak		2009-2008
	Caprice		1996-1994
	Cavalier		1998-1995
	Express 1500		1997-1996
	Express 2500		1997-1996
	Express 3500		2002-2001
	K1500		1997-1996
	Malibu		1998-1997
	P30		1997-1996
S10		1997-1996	
Silverado 2500 HD		2006-2001	
Silverado 2500 HD Classic		2007	
Silverado 3500		2006-2001	
Silverado 3500 Classic		2007	
Suburban 2500		2006-2001	
GMC	C1500		1997-1996
	C3500HD		2002-1996
	C4500 Topkick		2009-2008
	C5500 Topkick		2009-2008
	C6500 Topkick		2009-2008
	C7500 Topkick		2009-2008
	Jimmy		1997-1996



7862 (Cont'd)		PZTR5A-15	Laser Platinum	7938 (Cont'd)		BKR5E	V-Power
Qty per Vehicle: 4-8			Box Qty: 4	Qty per Vehicle: 4-24			Box Qty: 4
GMC	K1500		1997-1996	Chevrolet	Beretta		1994-1992
	P3500		1997-1996		Dodge	Ram 2500	
	Savana 1500		1997-1996			Ram 3500	
	Savana 2500		1997-1996	Hyundai	Sonata		2006
	Savana 3500		2002-2001	Jaguar	S-Type		2008
	Sierra 2500 HD		2006-2001		Super V8		2009-2006
	Sierra 2500 HD Classic		2007		Vanden Plas		2002-2000
	Sierra 3500		2006-2001		Vanden Plas		2009-2006
	Sierra 3500 Classic		2007		XF		2010-2009
	Sonoma		1997-1996		XJ8		2002-2000
	Yukon XL 2500		2006-2001		XJ8		2009-2008
					XJR		1997
	Isuzu	Hombre		1999-1997	XJR		2009-2007
Mercury	Marauder		2004	XK		2009-2007	
Oldsmobile	Achieva		1993-1992	XK8		2002-2000	
	Achieva		1998-1995	XKR		2002-2000	
	Bravada		2001-1996	XKR		2009-2007	
	Cutlass Calais		1991-1989	Jeep	Cherokee		1990-1987
	Cutlass Ciera		1993-1989		Comanche		1990-1987
Pontiac	Cutlass Cruiser		1990-1989		Wagoneer		1990-1987
	Cutlass Cruiser		1994	Kia	Amanti		2009-2007
	Grand Am		1993-1992		Magentis		2008-2007
Grand Am		1998-1995	Optima			2008-2007	
Sunfire		1998-1995	Sportage			1995	
					Land Rover	LR3	
<b>7866</b>		<b>IFR5N10</b>	<b>Laser Iridium</b>		Range Rover		2009-2006
Qty per Vehicle: 8			Box Qty: 4		Range Rover Sport		2009-2006
Jaguar	S-Type		2008-2003	Mazda	Miata		2005-2004
	Super V8		2009-2005		Mercedes-Benz	300CE	
	Vanden Plas		2002-2000	300E			1993
	Vanden Plas		2009-2004	300SE			1993-1992
	XF		2010-2009	300SL			1993-1990
	XJ8		2002-2000	300TE			1993
	XJ8		2009-2004	400E			1993-1992
	XJR		2009-2004	400SE			1992
	XK		2009-2007	400SEL			1993
	XK8		2006-2000	500E			1993-1992
	XKR		2002-2000	500SEC			1993
	XKR		2009-2004	500SEL			1993-1992
	Land Rover	LR3		2009-2005		500SL	
	Range Rover		2009-2006	600SEC			1993
	Range Rover Sport		2009-2006	600SEL		1993-1992	
<b>7913</b>		<b>SILFR6A</b>	<b>Laser Iridium</b>		600SL		1993
Qty per Vehicle: 4-16			Box Qty: 4		C36 AMG		1997-1995
Dodge	Challenger		2017-2015		C43 AMG		2000-1998
	Charger		2017-2015		C220		1996-1994
Subaru	Forester		2013-2009		C230		1998-1997
	Impreza		2014-2008		C240		2002-2001
	Legacy		2009-2005		C280		1997-1994
	Outback		2009-2005		C280		2000-1999
	Tribeca		2009-2008		C320		2002-2001
	WRX		2014-2013		CL55 AMG		2002-2001
	WRX STI		2018-2013	CL500		2002-1998	
<b>7938</b>		<b>BKR5E</b>	<b>V-Power</b>		CL600		1999-1998
Qty per Vehicle: 4-24			Box Qty: 4		CL600		2001
Bentley	Arnage		2009-2000		CLK55 AMG		2002-2001
	Azure		2003-1996		CLK320		2002-1998
	Azure		2008-2006		CLK430		2002-1999
	Brooklands		1998-1993		E55 AMG		2002-1999
	Continental		2003-1985		E320		2002-1994
	Corniche		1984		E420		1995-1994
	Eight		1984		E420		1997
	Eight		1991-1986		E430		2002-1998
	Mulsanne		1992-1984		E500		1994
	Turbo R		1998-1988		G500		2002
	Cadillac	Catera		2001-1997			



7938 (Cont'd)		BKR5E	V-Power	7969 (Cont'd)		BKR6EKUB	Standard
Qty per Vehicle: 4-24			Box Qty: 4	Qty per Vehicle: 4-12			Box Qty: 4
Mercedes-Benz	ML55 AMG		2002-2000	Audi	S6		2002
	ML320		2002-1998		S8		2002-2001
	ML430		2001-1999	Bentley	Arnage		1999
	ML500		2002		BMW	320i	
	S55 AMG		2002-2001	320i			2005-2001
	S320		1999-1994	323Ci			2000
	S420		1999-1994	323i			2000-1998
	S430		2002-2000	323is			1999-1998
	S500		1999-1994	325Ci			2006-2001
	S600		1999-1994	325i			2005-2001
	S600		2001	325xi			2005-2001
	SL320		1997-1994	328Ci			2000
	SL500		1998-1994	328i			2000-1996
	SL500		2002-2001	328is			1999-1996
	SL600		2002-1994	330Ci			2006-2001
	SLK320		2002-2001	330i		2005-2001	
	Mitsubishi	Eclipse		2005-2004	330xi		2005-2001
		Lancer		2010-2009	525i		2005-2001
Outlander			2010-2008	528i		2000-1997	
Oldsmobile	Achieva		1994-1992	530i		2005-2001	
Peugeot	405		1991-1989	540i		2003-1998	
Pontiac	Grand Am		1994-1993	545i		2005-2004	
Rolls-Royce	Corniche		2002-2000	645Ci		2005-2004	
	Silver Dawn		1997-1995	740i		2001-1998	
Saab	9-2X		2005	740iL		2001-1998	
Saturn	L300		2005-2001	745i		2005-2002	
	LS2		2000	745Li		2005-2002	
	LW2		2000	750iL		2001-1998	
	LW300		2003-2001	760i		2006-2004	
	Vue		2003-2002	760Li		2008-2003	
Subaru	Legacy		2004	M3		1999-1996	
Volkswagen	Cabrio		2001-1995	M5		2003-2000	
	Corrado		1995-1992	X3		2006-2004	
	EuroVan		1997	X5		2006-2000	
	EuroVan		2001-1999	Z3		2002-1997	
	EuroVan		2003	Z4		2005-2003	
	Golf		1999-1994	Z8		2003-2000	
	Golf		2002-2001	Cadillac	CTS		2004-2003
	Jetta		2002-1993	Land Rover	Range Rover		2005-2003
Passat		1997-1993	Mini	Cooper		2008-2002	
<b>7963</b>	<b>PFR7Q</b>	<b>Laser Platinum</b>		Morgan	Aero 8		2005-2004
Qty per Vehicle: 8			Box Qty: 4	Porsche	911		2002-2001
Audi	RS6		2004-2003		911		2005
Porsche	Cayenne		2006-2003		Boxster		2004-2001
<b>7966</b>	<b>UR6GP</b>	<b>G-Power</b>		Carrera GT		2005-2004	
Qty per Vehicle: 8			Box Qty: 4	Rolls-Royce	Park Ward		2002
Ford	Mustang		1972-1970		Phantom		2013-2004
	Mustang		1995		Silver Seraph		2002-1999
<b>7968</b>	<b>PZFR5D-11</b>	<b>Laser Platinum</b>		Volkswagen	Golf		2000
Qty per Vehicle: 4-6			Box Qty: 4	Passat		2005-1998	
Volkswagen	Beetle		2005-2001	<b>7990</b>	<b>BKR6EYA</b>	<b>V-Power</b>	
	EuroVan		2002-2001	Qty per Vehicle: 4-8			Box Qty: 4
	Golf		2006-2001	Mitsubishi	Eclipse		2012-2006
	Golf City		2010-2007		Galant		2009-2007
	Jetta		2005-2001	Toyota	Avalon		1999-1996
	Jetta City		2009-2007		Camry		2001-1996
<b>7969</b>	<b>BKR6EKUB</b>	<b>Standard</b>			RAV4		2000-1997
Qty per Vehicle: 4-12			Box Qty: 4		Sequoia		2004-2001
Audi	A4		1997		Sienna		2000-1998
	A4		2001-1999		Solara		2001-1999
	A4 Quattro		2001-1998	Tundra		2004-2000	
	A6		2001-1998	<b>7994</b>	<b>IFR5E11</b>	<b>Laser Iridium</b>	
	A6 Quattro		2002-1998	Qty per Vehicle: 4-16			Box Qty: 4
	A8 Quattro		2006-1997	Acura	RL		2004-1996



7994 (Cont'd)		IFR5E11	Laser Iridium	7994 (Cont'd)		IFR5E11	Laser Iridium	
Qty per Vehicle: 4-16			Box Qty: 4	Qty per Vehicle: 4-16			Box Qty: 4	
Acura	SLX		1999-1996	Mercedes-Benz	C280		1998	
	TL		1998-1995		C320		2005-2003	
	Vigor		1994-1992		CL500		2006-2003	
Chrysler	Cirrus		2000-1995		CLK320		2005-2003	
	Crossfire		2008-2004		CLK430		2003	
	Sebring		2005-1995		CLK500		2006-2003	
Dodge	Avenger		2000-1995		CLS500		2006	
	Colt		1994-1993		E320		2005-2003	
	Stratus		2000-1995		E500		2006-2003	
Eagle	Summit		1996-1992		G55 AMG		2004-2003	
Ford	EXP		1982		G500		2008-2003	
	Taurus		1995-1989		ML55 AMG		2003	
	Thunderbird		2005-2002		ML320		2003	
Honda	Passport		2002-1997		ML350		2005-2003	
Hyundai	Accent		2011-1995		ML500		2004-2003	
	Elantra		2007-1996		ML500		2007	
	Santa Fe		2006-2001		R500		2007-2006	
	Scoupe		1995-1993		S430		2006-2003	
	Sonata		2008-1999		S500		2006-2000	
	Tiburon		2001-1997		SL500		2000-1999	
	Tiburon		2008-2003	SL500		2006-2003		
	Tucson		2009-2005	SLK320		2004-2003		
	XG300		2001	Villager		2002-1999		
	XG350		2005-2002					
Infiniti	G20		2002-1999	Mitsubishi	Diamante		2004-1997	
	I30		2001-1996	Eclipse			2005-1996	
	J30		1997-1993	Expo			1995-1993	
	Q45		2001-1990	Expo LRV			1994-1992	
	QX4		2000-1997	Galant			2003-1992	
Isuzu	Amigo		2000-1998	Lancer			2007-2002	
	Axiom		2002	Mirage			2002-1993	
	Rodeo		2002-1996	Montero			2002-1994	
	Rodeo Sport		2002-2001	Montero Sport			2004-1997	
	Trooper		2002-1996	Outlander			2003	
	VehiCROSS		2001-1999					
Jaguar	S-Type		2002-2000	Nissan	240SX		1998-1991	
	Vanden Plas		1999-1997	300ZX			1996-1990	
	XJ8		1999-1998	Altima			2001-1993	
	XK8		1999-1997	Frontier			2004-1998	
Kia	Amanti		2006-2004	Maxima			2001-1992	
	Magentis		2008-2001	NX			1993-1991	
	Optima		2008-2001	Pathfinder			2000-1996	
	Rio		2011-2006	Quest			2002-1999	
	Rio5		2011-2006	Sentra			2001-1991	
	Rondo		2008-2007	Xterra			2004-2000	
	Sedona		2005-2002					
	Sephia		1997-1995	Plymouth	Colt		1994-1993	
	Sorento		2006-2003	Saab	9-2X		2006	
	Spectra		2007-2004	Subaru	Baja		2006-2004	
	Spectra5		2007-2005	Forester			1998	
	Sportage		2010-2005	Forester			2010-2005	
Lincoln	LS		2006-2000	Impreza			1998	
				Impreza			2011-2005	
Mazda	2		2014-2011	Legacy			1999-1996	
	323		1991-1990	Legacy			2009-2005	
	323		1994-1993	Outback			2009-2004	
	626		2002-1993					
	929		1995-1992	Volkswagen	Beetle		2004	
	Miata		1997-1994					
	Miata		2005-1999					
	MPV		1998-1996					
	MX-3		1996-1992					
	MX-6		1997-1993					
	Protege		2003-1990					
	Protege5		2003-2002					
	Mercedes-Benz	C240		2005-2003				
	<b>8196</b>				<b>DCPR6EIX</b>			<b>Iridium IX</b>
Qty per Vehicle: 6				Box Qty: 4				
BMW		M5					1993-1991	
<b>9029</b>				<b>DILKAR6A11</b>			<b>Laser Iridium</b>	
Qty per Vehicle: 4				Box Qty: 4				
Chevrolet		City Express					2017-2015	
Nissan		Altima					2013-2007	
		Cube					2014-2009	
		NV200					2017-2013	
		Rogue					2013-2008	



9029 (Cont'd)		DILKAR6A11	Laser Iridium
Qty per Vehicle: 4		Box Qty: 4	
Nissan	Rogue Select	2015-2014	
	Sentra	2017-2007	
	Versa	2012-2007	
9723		SILZKR7B11	Laser Iridium
Qty per Vehicle: 4-6		Box Qty: 4	
Chrysler	200	2017-2011	
	300	2017-2011	
	Town & Country	2016-2011	
Dodge	Avenger	2014-2011	
	Challenger	2017-2011	
	Charger	2017-2011	
	Durango	2015-2011	
	Grand Caravan	2017-2011	
	Journey	2017-2011	
Hyundai	Azera	2017-2012	
	Elantra	2016-2012	
	Elantra Coupe	2014-2013	
	Elantra GT	2015-2013	
	Genesis Coupe	2016-2010	
	Santa Fe	2018-2010	
	Santa Fe XL	2018-2013	
	Tucson	2017-2014	
Jeep	Cherokee	2017-2014	
	Grand Cherokee	2015-2011	
	Wrangler	2017-2012	
Kia	Cadenza	2017-2014	
	Forte	2017-2014	
	Forte5	2017-2014	
	Forte Koup	2016-2014	
	Rondo	2017-2014	
	Sedona	2012-2011	
	Sedona	2017-2014	
	Sorento	2017-2011	
	Soul	2017-2012	
	Ram	1500	2017-2013
C/V		2015-2012	
ProMaster 1500		2017-2014	
ProMaster 2500		2017-2014	
ProMaster 3500		2017-2014	
Volkswagen	Routan	2014-2011	
90074		DILZKR7A11DS	Laser Iridium
Qty per Vehicle: 6		Box Qty: 4	
Honda	Pilot	2013-2012	
90083		LTR5BI-13	Laser Iridium
Qty per Vehicle: 4		Box Qty: 4	
Mazda	3	2013-2006	
	3 Sport	2010-2009	
	3 Sport	2013-2012	
	5	2010-2008	
	5	2015-2012	
	6	2013-2006	
	CX-7	2012-2010	
	Tribute	2011-2009	
90117		ILTR6E11	Laser Iridium
Qty per Vehicle: 6-16		Box Qty: 4	
Buick	Allure	2008-2006	
	Allure	2010	
	Enclave	2017-2008	
	LaCrosse	2008-2006	
	LaCrosse	2016-2010	
Cadillac	ATS	2015-2013	
	CTS	2015-2006	
	SRX	2016-2006	
	STS	2011-2006	

90117 (Cont'd)		ILTR6E11	Laser Iridium	
Qty per Vehicle: 6-16		Box Qty: 4		
Cadillac	XTS	2017-2013		
	Chevrolet	Camaro	2015-2010	
		Caprice	2017-2012	
		Captiva Sport	2012	
		Colorado	2016-2015	
		Equinox	2017-2008	
		Impala	2017-2012	
		Impala Limited	2016-2014	
		Malibu	2012-2008	
		Traverse	2017-2009	
		Ford	E-350 Super Duty	2017
F-150	2014-2010			
F-250 Super Duty	2017-2011			
F-350 Super Duty	2017-2011			
GMC	Acadia	2016-2007		
	Acadia Limited	2017		
	Canyon	2016-2015		
	Terrain	2017-2010		
Mazda	6	2013-2009		
	CX-9	2015-2007		
Pontiac	G6	2009-2007		
	G8	2009-2008		
	Torrent	2009-2008		
Saab	9-4X	2011		
Saturn	Aura	2009-2007		
	Outlook	2010-2007		
	Vue	2010-2008		
90137		DILZKAR7C11S	Laser Iridium	
Qty per Vehicle: 4		Box Qty: 4		
Honda	Fit	2018-2015		
90156		ITR6G9	Laser Iridium	
Qty per Vehicle: 8		Box Qty: 4		
Chevrolet	Camaro	2015-2012		
	Corvette	2013-2009		
Ford	Mustang	2014-2013		
90174		DF8H-11B	Laser Iridium	
Qty per Vehicle: 6		Box Qty: 4		
Infiniti	EX37	2013		
	FX37	2013		
	G37	2013-2008		
	M37	2013-2011		
	Q40	2015		
	Q50	2015-2014		
	Q60	2015		
	Q70	2017-2014		
	Q70L	2017-2015		
	QX50	2017-2014		
QX70	2017-2014			
Nissan	370Z	2017-2009		
90192		LZFR5AGP-E	G-Power	
Qty per Vehicle: 8-16		Box Qty: 4		
Chrysler	Aspen	2009-2008		
	Dodge	Dakota	2010-2008	
		Durango	2009-2008	
Ram 1500		2010-2008		
Jeep	Commander	2009-2008		
	Grand Cherokee	2009-2008		
Ram	1500	2013-2011		
	Dakota	2011		
90198		LTR6GP	G-Power	
Qty per Vehicle: 6-16		Box Qty: 4		
Buick	Allure	2008-2005		
	Allure	2010		





90198 (Cont'd)		LTR6GP	G-Power	90220 (Cont'd)		LTR5AHX	Ruthenium HX
Qty per Vehicle: 6-16			Box Qty: 4	Qty per Vehicle: 4-8			Box Qty: 4
Buick	Enclave		2017-2008	Ford	C-Max		2017-2013
	LaCrosse		2008-2005		Edge		2011-2007
	LaCrosse		2016-2010		Escape		2017-2009
	Rendezvous		2006-2004		Flex		2012-2009
Cadillac	ATS		2015-2013		Fusion		2018-2006
	CTS		2015-2004		Taurus		2012-2008
	SRX		2016-2004		Taurus X		2009-2008
	STS		2011-2005	Transit Connect		2017-2014	
	XTS		2017-2013	GMC	Acadia		2017
Chevrolet	Camaro		2015-2010		Canyon		2012-2004
	Caprice		2017-2012		Canyon		2016-2015
	Captiva Sport		2012		Envoy		2009-2002
	Colorado		2016-2015		Envoy XL		2006-2002
	Equinox		2017-2008		Envoy XUV		2005-2004
	Impala		2017-2012		Sierra 1500		2017-2014
	Impala Limited		2016-2014		Terrain		2017-2010
	Malibu		2012-2008		Yukon		2017-2015
Traverse		2017-2009	Yukon XL			2017-2015	
Ford	E-350 Super Duty		2017	Hummer	H3		2010-2006
	F-150		2014-2010	H3T		2010-2009	
	F-250 Super Duty		2017-2011	Isuzu	Ascender		2008-2003
	F-350 Super Duty		2017-2011		i-280		2006
GMC	Acadia		2016-2007		i-290		2008-2007
	Acadia Limited		2017		i-350		2006
	Canyon		2016-2015	i-370		2008-2007	
Mazda	Terrain		2017-2010	Lincoln	MKS		2013-2009
	6		2013-2009		MKT		2012-2010
Pontiac	CX-9		2015-2007		MKX		2010-2007
	G6		2009-2007		MKZ		2017-2007
Suzuki	G8		2009-2008	Mazda	3		2013-2006
	Torrent		2009-2008		3 Sport		2013-2009
Saab	9-4X		2011		5		2010-2008
Saturn	Aura		2009-2007		5		2015-2012
	Outlook		2010-2007		6		2013-2006
Suzuki	Vue		2010-2008		CX-7		2012-2010
	Grand Vitara		2010-2009		Tribute		2011-2009
	XL-7		2009-2007	Mercury	Mariner		2011-2009
<b>90220</b>		<b>LTR5AHX</b>	<b>Ruthenium HX</b>		Milan		2011-2006
Qty per Vehicle: 4-8			Box Qty: 4		Sable		2009-2008
Buick	Allure		2010	Oldsmobile	Bravada		2004-2002
	Envision		2017	Pontiac	G5		2010-2007
	LaCrosse		2016-2010		G6		2010-2006
	Rainier		2007-2004		Pursuit		2006
	Regal		2017-2011		Solstice		2009-2006
	Cadillac	Verano		2017-2012	Saab	9-7x	
ATS			2017-2013	Saturn	Aura		2010-2007
Escalade			2017-2015		Ion		2007-2006
Escalade ESV		2017-2015	Sky			2010-2007	
Chevrolet	Vue		2010-2008		Vue		2010-2007
	Camaro		2017-2016	<b>90223</b>		<b>PLZKBR7B8DG</b>	<b>Laser Platinum</b>
	Captiva Sport		2015-2012	Qty per Vehicle: 4			Box Qty: 4
	Cobalt		2010-2006	Mini	Cooper		2015-2007
	Colorado		2012-2004		Cooper Countryman		2016-2011
	Colorado		2016-2015		Cooper Paceman		2016-2013
	Corvette		2017-2014	<b>90318</b>		<b>ZFR6U-9</b>	<b>V-Power</b>
	Equinox		2017-2010	Qty per Vehicle: 4			Box Qty: 10
	HHR		2011-2006	Chevrolet	Aveo		2011-2009
	Impala		2017-2014		Aveo5		2011-2009
	Malibu		2015-2007	Pontiac	G3		2010-2009
	Malibu Limited		2016		G3 Wave		2009
	Orlando		2014-2012	Suzuki	Swift+		2009
	Silverado 1500		2017-2014	<b>90374</b>		<b>LTR6DP13</b>	<b>Laser Platinum</b>
	Suburban		2017-2015	Qty per Vehicle: 8			Box Qty: 4
	Tahoe		2017-2015	Ford	F-150		2017-2015
	Trailblazer		2009-2002				
	Trailblazer EXT		2006-2002				



<b>90374 (Cont'd)</b>		<b>LTR6DP13</b>	<b>Laser Platinum</b>
Qty per Vehicle: 8			Box Qty: 4
Ford	Mustang		2017-2015
<b>90465</b>		<b>LKR8BHX-S</b>	<b>Ruthenium HX</b>
Qty per Vehicle: 4-10			Box Qty: 4
Acura	RDX		2012-2007
BMW	M3		2013-2008
	M5		2010-2006
	M6		2010-2006
Honda	Civic		2015-2012
<b>90495</b>		<b>LTR6BHX</b>	<b>Ruthenium HX</b>
Qty per Vehicle: 4-16			Box Qty: 4
Buick	Envision		2017-2016
	Regal		2017-2014
Cadillac	ATS		2017-2014
	CT6		2017-2016
	CTS		2017-2014
	SRX		2011-2010
Chevrolet	Camaro		2017-2016
	Malibu		2017-2014
Ford	E-350 Super Duty		2017
	Edge		2017-2012
	Escape		2017-2013
	Expedition		2017-2015
	Explorer		2017-2012
	F-150		2017-2010
	F-250 Super Duty		2017-2011
	F-350 Super Duty		2017-2011
	Fiesta		2017-2011
	Flex		2017-2010
	Focus		2017-2013
	Fusion		2018-2013
	Mustang		2017-2015
	Police Interceptor Sedan		2017-2013
	Police Interceptor Utility		2017-2014
	Special Service Police Sedan		2017-2014
	Taurus		2017-2010
	Transit-150		2017-2015
	Transit-250		2017-2015
	Transit-350		2017-2015
Transit-350 HD		2017-2015	
Transit Connect		2016-2014	
Jaguar	XE		2017
	XF		2015-2013
Land Rover	Discovery Sport		2016-2015
	LR2		2015-2013
	Range Rover Evoque		2016-2012
Lincoln	MKC		2017-2015
	MKS		2016-2010
	MKT		2017-2010
	MKZ		2017-2013
	Navigator		2017-2015
Mazda	3		2013-2007
	6		2007-2006
	CX-7		2012-2007
<b>90543</b>		<b>ILTR7E9</b>	<b>Laser Iridium</b>
Qty per Vehicle: 6			Box Qty: 4
Cadillac	CT6		2017-2016
	CTS		2014
	XTS		2015-2014
<b>90607</b>		<b>ILTR5K13</b>	<b>Laser Iridium</b>
Qty per Vehicle: 4-6			Box Qty: 4
Ford	C-Max		2017-2013
	Edge		2011-2007
	Escape		2017-2009
	Flex		2012-2009

<b>90607 (Cont'd)</b>		<b>ILTR5K13</b>	<b>Laser Iridium</b>	
Qty per Vehicle: 4-6			Box Qty: 4	
Ford	Fusion		2018-2006	
	Taurus		2012-2008	
	Taurus X		2009-2008	
	Transit Connect		2017-2014	
Lincoln	MKS		2013-2009	
	MKT		2012-2010	
	MKX		2010-2007	
	MKZ		2017-2007	
Mercury	Mariner		2011-2009	
	Milan		2011-2006	
	Sable		2009-2008	
<b>90654</b>		<b>SILZKFR8E7S</b>	<b>Laser Iridium</b>	
Qty per Vehicle: 4			Box Qty: 4	
Infiniti	Q50		2017-2016	
Mercedes-Benz	B250		2013	
	B250		2017-2015	
	C300		2017-2015	
	C350e		2017-2016	
	CLA250		2017-2014	
	E300		2017	
	GLA250		2017-2015	
	GLC300		2017-2016	
	Metris		2017-2016	
	SLC300		2017	
	SLK300		2016	
	<b>90656</b>		<b>ILTR6F9</b>	<b>Laser Iridium</b>
	Qty per Vehicle: 4			Box Qty: 4
Ford	Focus		2012	
<b>90804</b>		<b>ZFR5BGP</b>	<b>G-Power</b>	
Qty per Vehicle: 4-12			Box Qty: 4	
Acura	MDX		2006-2003	
Honda	Odyssey		2010-2005	
	Pilot		2008-2006	
	Ridgeline		2008-2006	
Saturn	Vue		2007-2004	
Volkswagen	Beetle		2008-2001	
	EuroVan		2002-2001	
	Golf		2006-2001	
	Golf City		2010-2007	
	Jetta		2007-2001	
	Jetta City		2009-2007	
	Phaeton		2006	
	Rabbit		2009-2006	
<b>90813</b>		<b>TR5AI-13</b>	<b>Laser Iridium</b>	
Qty per Vehicle: 4-8			Box Qty: 4	
Mazda	5		2007-2006	
	6		2005-2003	
	B2300		1997-1994	
	B2300		2010-2001	
	B2500		2001-1998	
	B3000		2008-1994	
	B4000		1996-1994	
	B4000		2003	
	MPV		2006-2000	
	Navajo		1994-1991	
	Tribute		2006-2001	
	Tribute		2008	
	<b>90882</b>		<b>ILTR5M9G</b>	<b>Laser Iridium</b>
Qty per Vehicle: 4			Box Qty: 4	
Cadillac	ATS		2013	
Chevrolet	Malibu		2013	



<b>90935</b>	<b>DILZKAR7B11</b>	<b>Laser Iridium</b>	<b>91276 (Cont'd)</b>	<b>LTR6AHX</b>	<b>Ruthenium HX</b>	
Qty per Vehicle: 4		Box Qty: 4	Qty per Vehicle: 4-8		Box Qty: 4	
Subaru	Crosstrek	2016	GMC	Acadia Limited	2017	
	XV Crosstrek	2015-2014		Canyon	2016-2015	
				Terrain	2017-2010	
<b>91039</b>	<b>IFR7X7G</b>	<b>Laser Iridium</b>	Lincoln	Continental	2017	
Qty per Vehicle: 4		Box Qty: 4		MKS	2016-2014	
Buick	Encore	2016-2013		MKT	2017-2012	
Chevrolet	Cruze	2015-2011		MKX	2017-2011	
	Cruze Limited	2016		MKZ	2016-2013	
	Sonic	2017-2012	Mazda	6	2013-2009	
	Trax	2017-2013		CX-9	2015-2007	
				MX-5 Miata	2015-2006	
<b>91187</b>	<b>LKAR6AIX-11</b>	<b>Iridium IX</b>	Pontiac	G6	2009-2007	
Qty per Vehicle: 4		Box Qty: 4		G8	2009-2008	
Chevrolet	City Express	2017-2015		Torrent	2009-2008	
			Saab	9-4X	2011	
Nissan	Altima	2013-2007	Saturn	Aura	2009-2007	
	Cube	2014-2009		Outlook	2010-2007	
	Frontier	2017-2005		Vue	2010-2008	
	Micra	2017-2015	Suzuki	Grand Vitara	2010-2009	
	NV200	2017-2013		XL-7	2009-2007	
	Rogue	2013-2008				
	Rogue Select	2015-2014	<b>91356</b>	<b>LKR6AHX</b>	<b>Ruthenium HX</b>	
	Sentra	2017-2007	Qty per Vehicle: 4-6		Box Qty: 4	
	Versa	2017-2007	Hyundai	Elantra	2011	
	Versa Note	2017-2014		Genesis	2009	
			Kia	Borrego	2011-2009	
<b>91215</b>	<b>DILKAR7C9H</b>	<b>Laser Iridium</b>	<b>91418</b>	<b>ILTR5E11</b>	<b>Laser Iridium</b>	
Qty per Vehicle: 4		Box Qty: 4	Qty per Vehicle: 4-5		Box Qty: 4	
Infiniti	QX60	2016-2014	Chevrolet	Cobalt	2010-2009	
Nissan	Juke	2017-2011			Colorado	2012-2010
	Murano	2016			HHR	2011-2009
	Pathfinder	2014			Malibu	2012-2009
			GMC	Canyon	2012-2010	
<b>91276</b>	<b>LTR6AHX</b>	<b>Ruthenium HX</b>	Hummer	H3	2010	
Qty per Vehicle: 4-8		Box Qty: 4		H3T	2010	
Buick	Allure	2008-2005	Isuzu	i-370	2007	
	Allure	2010	Pontiac	G6	2010	
	Enclave	2017-2008	Saturn	Aura	2010-2009	
	LaCrosse	2008-2005		Sky	2010-2009	
	LaCrosse	2016-2010				
	Rendezvous	2006-2004	<b>91448</b>	<b>DILKR8B6</b>	<b>Laser Iridium</b>	
Cadillac	ATS	2015-2013	Qty per Vehicle: 4		Box Qty: 4	
	CTS	2015-2004	Mitsubishi	Lancer	2015-2011	
	SRX	2016-2004	<b>91467</b>	<b>SILZKR7E9G</b>	<b>Laser Iridium</b>	
	STS	2011-2005	Qty per Vehicle: 4		Box Qty: 4	
	XTS	2017-2013	Hyundai	Sonata	2015	
Chevrolet	Camaro	2015-2010	Kia	Sorento	2016	
	Caprice	2017-2012	<b>91568</b>	<b>SILZKR6D8E</b>	<b>Laser Iridium</b>	
	Captiva Sport	2012	Qty per Vehicle: 4		Box Qty: 4	
	Colorado	2016-2015	Hyundai	Veloster	2014-2013	
	Equinox	2017-2008	Kia	Forte5	2016-2014	
	Impala	2017-2012		Forte Koup	2016-2014	
	Impala Limited	2016-2014	<b>91578</b>	<b>DILKAR7G11GS</b>	<b>Laser Iridium</b>	
	Malibu	2012-2008	Qty per Vehicle: 4		Box Qty: 4	
	Traverse	2017-2009	Honda	Accord	2017-2013	
				Civic	2017-2016	
Ford	Edge	2017-2011	<b>91715</b>	<b>IKR7H8</b>	<b>Laser Iridium</b>	
	Explorer	2017-2011	Qty per Vehicle: 4		Box Qty: 4	
	F-150	2017-2011	Chevrolet	Spark	2015-2013	
	Flex	2017-2012	Fiat	500	2017-2014	
	Focus	2017-2012	<b>91725</b>	<b>LTR6BI-13</b>	<b>Laser Iridium</b>	
	Mustang	2017-2011	Qty per Vehicle: 4		Box Qty: 4	
	Police Interceptor Sedan	2017-2013	Mazda	MX-5 Miata	2015-2006	
	Police Interceptor Utility	2017-2013				
	Taurus	2017-2013				
	Transit-150	2017-2015				
	Transit-250	2017-2015				
	Transit-350	2017-2015				
	Transit-350 HD	2017-2015				
GMC	Acadia	2016-2007				



91784 LKAR8BHX Ruthenium HX		Qty per Vehicle: 6	Box Qty: 4
Infiniti	EX37		2013
	FX37		2013
	G37		2013-2008
	M37		2013-2011
	Q40		2015
	Q50		2015-2014
	Q60		2015
	Q70		2017-2014
	Q70L		2017-2015
	QX50		2017-2014
Nissan	370Z		2017-2009
	GT-R		2017-2009

91924 ILZNR8A7G Laser Iridium		Qty per Vehicle: 4	Box Qty: 4
Ford	Escape		2017
	Fusion		2018-2014

91961 DILFR7K9G Laser Iridium		Qty per Vehicle: 4	Box Qty: 4
Lexus	GS200t		2016
	GS Turbo		2017
	IS200t		2016
	IS Turbo		2017
	NX200t		2017-2015
	RC200t		2016
	RC Turbo		2017

91970 ILNAR8B7G Laser Iridium		Qty per Vehicle: 4	Box Qty: 4
Buick	Cascade		2017-2016
Chevrolet	Cruze		2017-2016
	Malibu		2017-2016

92041 ZFR5AP Laser Platinum		Qty per Vehicle: 4	Box Qty: 4
Chrysler	200		2014-2011
	Sebring		2010-2008
Dodge	Avenger		2014-2008
	Caliber		2010-2008
	Journey		2010-2009
Jeep	Compass		2009
	Patriot		2009

92085 IFR6V-10G Laser Iridium		Qty per Vehicle: 4	Box Qty: 4
Chevrolet	Cobalt		2007-2005
Saturn	Ion		2007-2004

92145 LZFR5CI-11 Laser Iridium		Qty per Vehicle: 4-16	Box Qty: 4
Chrysler	200		2017-2015
	300		2017-2009
	Aspen		2009-2008
Dodge	Challenger		2017-2009
	Charger		2017-2009
	Dakota		2010-2008
	Dart		2016-2013
	Durango		2009-2008
	Durango		2017-2011
	Ram 1500		2010-2008
	Ram 2500		2010-2009
	Ram 3500		2009
	Fiat	500X	
Jeep	Cherokee		2017-2014
	Commander		2010-2008
	Grand Cherokee		2017-2008
	Renegade		2017-2015

92145 (Cont'd) LZFR5CI-11 Laser Iridium		Qty per Vehicle: 4-16	Box Qty: 4
Ram	1500		2017-2011
	2500		2017-2011
	3500		2017-2011
	Dakota		2011
	ProMaster City		2017-2015

92174 LZFR5C-11 Standard		Qty per Vehicle: 4-16	Box Qty: 4
Chrysler	200		2017-2015
	300		2017-2009
	Aspen		2009-2008
Dodge	Challenger		2017-2009
	Charger		2017-2009
	Dakota		2010-2008
	Dart		2016-2013
	Durango		2009-2008
	Durango		2017-2011
	Ram 1500		2010-2008
	Ram 2500		2010-2009
	Ram 3500		2009
	Fiat	500X	
Jeep	Cherokee		2017-2014
	Commander		2010-2008
	Grand Cherokee		2017-2008
	Renegade		2017-2015
Ram	1500		2017-2011
	2500		2017-2011
	3500		2017-2011
	Dakota		2011
	ProMaster City		2017-2015

92182 LTR6BI-9 Laser Iridium		Qty per Vehicle: 4	Box Qty: 4
Ford	Focus		2017-2012

92213 ZFR6BGP-S G-Power		Qty per Vehicle: 4-6	Box Qty: 4
Acura	CSX		2011-2006
	MDX		2009-2007
	RL		2008-2005
	RSX		2006-2002
	TL		2008-2004
	TSX		2008-2004
Honda	Accord		2007-2003
	Civic		2011-2002
	CR-V		2009-2002
	Element		2011-2003
	Fit		2014-2007

92217 DILKAR7B8 Laser Iridium		Qty per Vehicle: 4	Box Qty: 4
Subaru	Impreza		2018-2017

92264 SPMR8A6HDG Laser Platinum		Qty per Vehicle: 8	Box Qty: 4
Ferrari	California		2013-2009

92274 LKAR7AHX-S Ruthenium HX		Qty per Vehicle: 4-8	Box Qty: 4
Acura	ILX		2017-2016
	TLX		2018-2015
Honda	Accord		2017-2013
	Civic		2016
	CR-V		2017-2015
	Fit		2018-2015
Infiniti	EX35		2012-2008
	FX35		2012-2009
	FX50		2013-2009
	G25		2012-2011



92274 (Cont'd)	LKAR7AHX-S	Ruthenium HX
Qty per Vehicle: 4-8		Box Qty: 4
Infiniti	G35	2008-2007
	JX35	2013
	M35	2010-2009
	M35h	2013-2012
	M56	2013-2011
	Q50	2016-2014
	Q60	2014
	Q70	2017-2014
	Q70L	2017-2015
	QX56	2013-2011
	QX60	2017-2014
	QX70	2014
	QX80	2017-2014
	Lexus	CT200h
Mazda	3	2016-2012
	3 Sport	2016-2011
	6	2017-2014
	CX-3	2017-2016
	CX-5	2016-2013
	MX-5 Miata	2017-2016
Nissan	350Z	2009-2007
	Altima	2017-2007
	Armada	2017
	Maxima	2014-2009
	Maxima	2017-2016
	Murano	2017-2009
	NV2500	2018
	NV3500	2018
	Pathfinder	2017-2013
	Quest	2017-2011
	Titan	2017
Titan XD	2017-2016	
Pontiac	Vibe	2010-2009
Scion	iQ	2014-2012
	xD	2014-2008
Subaru	Crosstrek	2017-2016
	Forester	2018-2011
	Impreza	2016-2012
	Legacy	2017-2013
	Outback	2017-2013
	XV Crosstrek	2015-2013
Toyota	Corolla	2015-2009
	Matrix	2014-2009
	Prius	2015-2010
	Prius Plug-In	2015-2012
	Prius V	2015-2012
92315	SILZKR7E11	Laser Iridium
Qty per Vehicle: 4-6		Box Qty: 4
Genesis	G80	2018
Hyundai	Sonata	2018-2015
Kia	Optima	2017-2016
	Sorento	2017-2015
	Sportage	2017-2016
92373	SILFR5A11	Laser Iridium
Qty per Vehicle: 4		Box Qty: 4
Suzuki	SX4	2013-2010
	SX4 Crossover	2012
92375	FR5AHX-E	Ruthenium HX
Qty per Vehicle: 4-8		Box Qty: 4
Chrysler	200	2014-2011
	Sebring	2010-2008
Dodge	Avenger	2014-2008
	Caliber	2010-2009
	Journey	2010-2009

92375 (Cont'd)	FR5AHX-E	Ruthenium HX
Qty per Vehicle: 4-8		Box Qty: 4
Ford	Thunderbird	2005-2002
Jeep	Compass	2009
	Patriot	2009
Lincoln	LS	2006-2003
92400	FR7BHX-S	Ruthenium HX
Qty per Vehicle: 4-10		Box Qty: 4
Acura	CSX	2010-2007
	RSX	2006-2002
Audi	A3	2013-2006
	A3 Quattro	2013-2009
	A4	2016-2005
	A4 allroad	2016-2013
	A4 Quattro	2016-2005
	A5	2014-2010
	A5 Quattro	2017-2010
	A6	2008-2006
	A6	2015-2012
	A6 Quattro	2008-2005
	A6 Quattro	2015-2013
	allroad	2015-2013
	Q3	2017-2015
	Q3 Quattro	2017-2015
	Q5	2017-2011
	R8	2012-2008
R8	2015-2014	
R8	2017	
RS4	2008-2007	
RS5	2015-2013	
RS6	2004-2003	
TT	2009-2008	
TT Quattro	2015-2009	
BMW	Alpina B7	2008-2007
Buick	Encore	2017-2013
Chevrolet	Cruze	2015-2011
	Cruze Limited	2016
	Sonic	2017-2012
	Trax	2017-2013
Honda	Civic	2011-1998
	S2000	2009-2000
Porsche	Cayenne	2006-2003
Volkswagen	Beetle	2013-2012
	CC	2017-2009
	Eos	2016-2007
	Golf	2013
	Golf R	2012
	GTI	2014-2006
	Jetta	2010-2006
	Jetta	2013-2012
	Passat	2010-2006
	Passat CC	2010-2009
	Tiguan	2017-2009
	92459	ZFR5FGP-8E
Qty per Vehicle: 4		Box Qty: 4
Chrysler	200	2014-2011
	Sebring	2010-2008
Dodge	Avenger	2014-2008
	Caliber	2010-2008
	Journey	2010-2009
Jeep	Compass	2009
	Patriot	2009
92460	LZFR5AIX-11E	Iridium IX
Qty per Vehicle: 8-16		Box Qty: 4
Chrysler	Aspen	2009-2008
Dodge	Dakota	2010-2008





<b>92460 (Cont'd) LZFR5AIX-11E Iridium IX</b>		<b>Qty per Vehicle: 8-16</b>	<b>Box Qty: 4</b>
Dodge	Durango	2009-2008	
	Ram 1500	2010-2008	
Jeep	Commander	2009-2008	
	Grand Cherokee	2009-2008	
Ram	1500	2013-2011	
	Dakota	2011	
<b>92491 DILFR6J11 Laser Iridium</b>		<b>Qty per Vehicle: 8</b>	<b>Box Qty: 4</b>
Acura	ILX	2015-2013	
Honda	Civic	2015-2012	
	Insight	2014-2010	
<b>92605 DILFR5E11 Laser Iridium</b>		<b>Qty per Vehicle: 8</b>	<b>Box Qty: 4</b>
Hyundai	Equus	2011	
	Genesis	2012-2009	
Kia	Borrego	2011-2009	
<b>92649 LKAR7BGP-S G-Power</b>		<b>Qty per Vehicle: 4</b>	<b>Box Qty: 4</b>
Honda	Accord	2017-2013	
	Civic	2017-2016	
	Fit	2018-2015	
Subaru	Crosstrek	2017-2016	
	Forester	2018-2011	
	Impreza	2016-2012	
	Legacy	2017-2013	
	Outback	2017-2013	
	XV Crosstrek	2015-2013	
<b>92714 TR6AHX Ruthenium HX</b>		<b>Qty per Vehicle: 4-12</b>	<b>Box Qty: 4</b>
Aston Martin	DB7	2000	
	Vanquish	2006-2002	
Chevrolet	Camaro	2015-2014	
	Corvette	2013-2006	
Ford	Crown Victoria	2005-1998	
	Escape	2005	
	Focus	2010-2003	
Jaguar	X-Type	2005-2002	
Mazda	3	2005-2004	
<b>92838 TR5C-12 Standard</b>		<b>Qty per Vehicle: 6</b>	<b>Box Qty: 4</b>
Ford	Escape	2012-2010	
	Fusion	2012-2010	
Mercury	Mariner	2011-2010	
	Milan	2011-2010	
<b>92873 LZKR6AIX Iridium IX</b>		<b>Qty per Vehicle: 4-6</b>	<b>Box Qty: 4</b>
Hyundai	Accent	2017-2012	
	Elantra	2011	
	Genesis	2009	
	Veloster	2017-2012	
Kia	Borrego	2011-2009	
	Rio	2017-2012	
	Soul	2017-2012	
<b>92924 DILZKR7A11G Laser Iridium</b>		<b>Qty per Vehicle: 6</b>	<b>Box Qty: 4</b>
Acura	TL	2014-2013	
Honda	Accord	2009-2008	
	Odyssey	2017-2011	
	Pilot	2015-2014	
<b>93026 DILKAR8A8 Laser Iridium</b>		<b>Qty per Vehicle: 6</b>	<b>Box Qty: 4</b>
Nissan	GT-R	2017-2009	

<b>93053 ILKR7E6 Laser Iridium</b>		<b>Qty per Vehicle: 4</b>	<b>Box Qty: 4</b>	
Mitsubishi	Lancer	2010-2009		
<b>93126 LKR6CIX Iridium IX</b>		<b>Qty per Vehicle: 4</b>	<b>Box Qty: 4</b>	
Hyundai	Veloster	2014-2013		
Kia	Forte5	2016-2014		
	Forte Koup	2016-2014		
<b>93135 DILKR7A11 Laser Iridium</b>		<b>Qty per Vehicle: 6-8</b>	<b>Box Qty: 4</b>	
Genesis	G80	2017		
Hyundai	Equus	2016-2012		
	Genesis	2016-2012		
Kia	K900	2017-2015		
<b>93175 LKR7DIX-11S Iridium IX</b>		<b>Qty per Vehicle: 4-8</b>	<b>Box Qty: 4</b>	
Acura	ILX	2015-2013		
	MDX	2017-2010		
	RDX	2018-2013		
	RL	2012-2009		
	RLX	2017-2014		
	TL	2014-2009		
	TLX	2018-2015		
	TSX	2014-2009		
	ZDX	2013-2010		
	Chrysler	200	2017-2011	
300		2017-2011		
Town & Country		2016-2011		
Dodge	Avenger	2014-2011		
	Challenger	2017-2011		
	Charger	2017-2011		
	Durango	2015-2011		
	Grand Caravan	2017-2011		
	Journey	2017-2011		
	Genesis	G80	2018-2017	
Honda	Accord	2017-2008		
	Accord Crosstour	2011-2010		
	Civic	2015-2012		
	Crosstour	2015-2012		
	CR-V	2014-2010		
	HR-V	2018-2016		
	Odyssey	2018-2008		
	Pilot	2017-2009		
	Ridgeline	2014-2009		
	Ridgeline	2018-2017		
	Hyundai	Azera	2017-2012	
	Elantra	2016-2012		
	Elantra Coupe	2014-2013		
	Elantra GT	2015-2013		
	Equus	2016-2012		
Genesis	2016-2012			
Genesis Coupe	2016-2010			
Santa Fe	2018-2010			
Santa Fe XL	2018-2013			
Sonata	2018-2015			
Tucson	2017-2014			
Jeep	Cherokee	2017-2014		
	Grand Cherokee	2015-2011		
	Wrangler	2017-2012		
Kia	Cadenza	2017-2014		
	Forte	2017-2014		
	Forte5	2017-2014		
	Forte Koup	2016-2014		
	K900	2017-2015		
	Optima	2017-2016		
	Rondo	2017-2014		



93175 (Cont'd)		LKR7DIX-11S	Iridium IX	93420		LFR6BHX	Ruthenium HX
Qty per Vehicle: 4-8			Box Qty: 4	Qty per Vehicle: 4-16			Box Qty: 4
Kia	Sedona		2012-2011	Dodge	Challenger		2017-2015
	Sedona		2017-2014		Charger		2017-2015
	Sorento		2017-2011	Land Rover	LR2		2012-2008
	Soul		2017-2012	Mercedes-Benz	C230		2005-2003
	Sportage		2017-2016		CL55 AMG		2006-2003
Mitsubishi	Outlander		2017-2014		CLS55 AMG		2006
Ram	1500		2017-2013		E55 AMG		2006-2003
	C/V		2015-2012		G55 AMG		2011-2005
	ProMaster 1500		2017-2014	S55 AMG		2006-2003	
	ProMaster 2500		2017-2014	SL55 AMG		2008-2003	
	ProMaster 3500		2017-2014	SLR McLaren		2009-2005	
Volkswagen	Routan		2014-2011	Mitsubishi	Eclipse		2012-2006
					Galant		2012-2004
					Lancer		2006-2004
					Outlander		2006-2004
93220		LKAR7AGP-D	G-Power	93476		SILZKAR7E8S	Laser Iridium
Qty per Vehicle: 4-8			Box Qty: 4	Qty per Vehicle: 6			Box Qty: 4
Infiniti	EX35		2012-2008	Jaguar	F-Pace		2017
	FX35		2012-2009		F-Type		2017-2014
	FX50		2013-2009	XE		2017	
	G25		2012-2011	XF		2017-2013	
	G35		2008-2007	XJ		2016-2013	
	JX35		2013	Land Rover	LR4		2016-2014
	M35		2010-2009		Range Rover		2016-2014
	M35h		2013-2012		Range Rover Sport		2016-2014
	M56		2013-2011				
	Q50		2016-2014				
	Q60		2014				
	Q70		2017-2014				
	Q70L		2017-2015				
	QX56		2013-2011				
	QX60		2017-2014				
	QX70		2014				
	QX80		2017-2014				
Lexus	CT200h		2015-2011				
Mazda	3		2016-2012				
	3 Sport		2016-2012				
	6		2017-2014				
	CX-3		2017-2016				
	CX-5		2016-2013				
	MX-5 Miata		2017-2016				
Nissan	350Z		2009-2007				
	Altima		2017-2007				
	Armada		2017				
	Maxima		2014-2009				
	Maxima		2017-2016				
	Murano		2017-2009				
	NV2500		2018				
	NV3500		2018				
	Pathfinder		2017-2013				
	Quest		2017-2011				
	Titan		2017				
	Titan XD		2017-2016				
Pontiac	Vibe		2010-2009				
Scion	iQ		2014-2012				
	xD		2014-2008				
Toyota	Corolla		2015-2009				
	Matrix		2014-2009				
	Prius		2015-2010				
	Prius Plug-In		2015-2012				
	Prius V		2015-2012				
93227		SILNAR7B7	Laser Iridium	93482		SILZKAR7B11	Laser Iridium
Qty per Vehicle: 4			Box Qty: 4	Qty per Vehicle: 4			Box Qty: 4
Chevrolet	Malibu		2017-2016	Subaru	Crosstrek		2017-2016
					Forester		2018-2011
					Impreza		2016-2012
					Legacy		2017-2013
					Outback		2017-2013
				XV Crosstrek		2015-2013	
93298		LZFR5BI-11	Laser Iridium	93501		LKAR7BIX-11S	Iridium IX
Qty per Vehicle: 3			Box Qty: 4	Qty per Vehicle: 4-8			Box Qty: 4
Mitsubishi	Mirage		2015-2014	Honda	Accord		2017-2013
					Civic		2017-2016
					Fit		2018-2015
				Infiniti	EX35		2012-2008
					FX35		2012-2009
					FX50		2013-2009
					G25		2012-2011



<b>93501 (Cont'd)</b>		<b>LKAR7BIX-11S</b>	<b>Iridium IX</b>
Qty per Vehicle: 4-8			Box Qty: 4
Infiniti	G35		2008-2007
	JX35		2013
	M35		2010-2009
	M35h		2013-2012
	M56		2013-2011
	Q50		2016-2014
	Q60		2014
	Q70		2017-2014
	Q70L		2017-2015
	QX56		2013-2011
	QX60		2017-2014
	QX70		2014
	QX80		2017-2014
Lexus	CT200h		2015-2011
Mazda	3		2016-2012
	3 Sport		2016-2012
	6		2017-2014
	CX-3		2017-2016
	CX-5		2016-2013
	MX-5 Miata		2017-2016
Nissan	350Z		2009-2007
	Altima		2017-2007
	Armada		2017
	Maxima		2014-2009
	Maxima		2017-2016
	Murano		2017-2009
	NV2500		2018
	NV3500		2018
	Pathfinder		2017-2013
	Quest		2017-2011
	Titan		2017
Titan XD		2017-2016	
Pontiac	Vibe		2010-2009
Scion	iQ		2014-2012
	xD		2014-2008
Subaru	Crosstrek		2017-2016
	Forester		2018-2011
	Impreza		2016-2012
	Legacy		2017-2013
	Outback		2017-2013
	XV Crosstrek		2015-2013
Toyota	Corolla		2015-2009
	Matrix		2014-2009
	Prius		2015-2010
	Prius Plug-In		2015-2012
	Prius V		2015-2012
<b>93580</b>	<b>PFR7N8DS</b>	<b>Laser Platinum</b>	
Qty per Vehicle: 4			Box Qty: 4
Honda	Civic		2005-1998
<b>93593</b>	<b>SILZNR8C7H</b>	<b>Laser Iridium</b>	
Qty per Vehicle: 3			Box Qty: 4
Ford	Fiesta		2017-2014
	Focus		2017-2015
<b>93618</b>	<b>SIKR9A7</b>	<b>Laser Iridium</b>	
Qty per Vehicle: 4			Box Qty: 4
Dodge	Dart		2016-2013
Fiat	124 Spider		2017
	500		2017-2012
	500L		2017-2014
	500X		2017-2016
Jeep	Renegade		2017-2015
<b>93655</b>	<b>SILZKR7E8EG</b>	<b>Laser Iridium</b>	
Qty per Vehicle: 4			Box Qty: 4
Hyundai	Veloster		2015-2014

<b>93655 (Cont'd)</b>		<b>SILZKR7E8EG</b>	<b>Laser Iridium</b>	
Qty per Vehicle: 4			Box Qty: 4	
Kia	Forte5		2016-2014	
	Forte Koup		2016-2014	
<b>93759</b>	<b>DILFR5A11</b>	<b>Laser Iridium</b>		
Qty per Vehicle: 6-8			Box Qty: 4	
Infiniti	QX56		2010-2007	
Nissan	Armada		2015-2007	
	Frontier		2017-2007	
	NV1500		2017-2012	
	NV2500		2017-2012	
	NV3500		2017-2012	
	Pathfinder		2012-2007	
	Titan		2015-2007	
	Xterra		2015-2007	
<b>93763</b>	<b>LKR6BHX-E</b>	<b>Ruthenium HX</b>		
Qty per Vehicle: 4			Box Qty: 4	
Hyundai	Accent		2017-2012	
	Veloster		2017-2012	
Kia	Forte5		2016-2014	
	Forte Koup		2016-2014	
	Rio		2017-2012	
	Soul		2017-2012	
<b>93815</b>	<b>SILZKR6B10E</b>	<b>Laser Iridium</b>		
Qty per Vehicle: 4			Box Qty: 4	
Hyundai	Accent		2017-2012	
	Veloster		2017-2012	
Kia	Rio		2017-2012	
	Soul		2017-2012	
<b>93858</b>	<b>TR5BP12</b>	<b>Laser Platinum</b>		
Qty per Vehicle: 6			Box Qty: 4	
Ford	Escape		2012-2009	
	Fusion		2012-2010	
Mazda	Tribute		2011-2009	
Mercury	Mariner		2011-2009	
	Milan		2011-2010	
<b>93893</b>	<b>LFR6AIX</b>	<b>Iridium IX</b>		
Qty per Vehicle: 4-16			Box Qty: 4	
Dodge	Challenger		2017-2015	
	Charger		2017-2015	
Land Rover	LR2		2012-2008	
Mercedes-Benz	C230		2005-2003	
	CL55 AMG		2006-2003	
	CLS55 AMG		2006	
	E55 AMG		2006-2003	
	G55 AMG		2011-2005	
	S55 AMG		2006-2003	
	SL55 AMG		2008-2003	
	SLR McLaren		2009-2005	
Mitsubishi	Eclipse		2012-2006	
	Galant		2012-2004	
	Lancer		2006-2004	
	Outlander		2006-2004	
Saab	9-2X		2006	
Subaru	B9 Tribeca		2007-2006	
	Baja		2006-2004	
	Forester		2013-2004	
	Impreza		2014-2004	
	Legacy		2012-2005	
	Outback		2009-2005	
	Tribeca		2009-2008	
	WRX		2014-2013	
	WRX STI		2018-2013	
	Volvo	C30		2013-2007
C70			2013-2006	



93893 (Cont'd)		LFR6AIX	Iridium IX	93911 (Cont'd)		LKR7AIX	Iridium IX
Qty per Vehicle: 4-16			Box Qty: 4	Qty per Vehicle: 3-8			Box Qty: 4
Volvo	S40		2011-2004	Mercedes-Benz	ML350		2011-2006
	S60		2009-2004		ML450		2011-2010
	S60		2012-2011		ML500		2006-2005
	S80		2011-2007		ML550		2011-2008
	V50		2011-2005		R350		2011-2006
	V70		2010-2004		S350		2006
	XC60		2011-2010		S400		2013-2010
	XC70		2011-2008		S450		2011-2008
	XC90		2011-2007		S550		2011-2007
					SL550		2012-2007
				SLK250		2015-2012	
				SLK280		2008-2006	
				SLK300		2011-2009	
				SLK350		2011-2005	
93911		LKR7AIX	Iridium IX	Mitsubishi	Outlander		2017-2007
Qty per Vehicle: 3-8			Box Qty: 4	Ram	1500		2017-2013
Chrysler	200		2017-2011		C/V		2015-2012
	300		2017-2011		ProMaster 1500		2017-2014
	Town & Country		2016-2011		ProMaster 2500		2017-2014
Dodge	Avenger		2014-2011		ProMaster 3500		2017-2014
	Challenger		2017-2011	Smart	Fortwo		2015-2008
	Charger		2017-2011	Volkswagen	Routan		2014-2011
	Durango		2015-2011	94017		LZKR6AGP-E	G-Power
	Grand Caravan		2017-2011	Qty per Vehicle: 4			Box Qty: 4
	Journey		2017-2011	Hyundai	Accent		2017-2012
	Sprinter 2500		2008-2007		Veloster		2017-2012
Sprinter 3500		2008-2007	Kia	Rio		2017-2012	
Freightliner	Sprinter 2500		2008-2007		Soul		2017-2012
	Sprinter 3500		2008-2007	94051		SILZNR6D9	Laser Iridium
Genesis	G80		2017	Qty per Vehicle: 4			Box Qty: 4
Hyundai	Azera		2017-2012	Chevrolet	Spark		2017-2016
	Elantra		2016-2012		Volt		2017-2016
	Elantra Coupe		2014-2013	94122		LFR6AHX-S	Ruthenium HX
	Elantra GT		2015-2013	Qty per Vehicle: 4-8			Box Qty: 4
	Equus		2016-2012	Acura	ILX		2015-2013
	Genesis		2016-2012	BMW	128i		2013-2008
	Genesis Coupe		2016-2010		323i		2011-2006
	Santa Fe		2018-2010		325i		2006
	Santa Fe XL		2018-2013		325xi		2006
	Tucson		2017-2014		328i		2013-2007
Jeep	Cherokee		2017-2014		328i xDrive		2013-2009
	Grand Cherokee		2015-2011		328xi		2008-2007
	Wrangler		2017-2012		330i		2006
Kia	Cadenza		2017-2014		330xi		2006
	Forte		2017-2014		525i		2007-2006
	Forte5		2017-2014		525xi		2007-2006
	Forte Koup		2016-2014		528i		2011-2008
	K900		2017-2015		528i xDrive		2010-2009
	Rondo		2017-2014		528xi		2008
	Sedona		2012-2011		530i		2007-2006
	Sedona		2017-2014		530xi		2007-2006
	Sorento		2017-2011	X3		2012-2007	
	Soul		2017-2010	X5		2010-2007	
Mercedes-Benz	C230		2009-2006	Z4		2011-2006	
	C250		2014-2010	Honda	Civic		2015-2006
	C280		2007-2006		Insight		2014-2010
	C300		2012-2008	Lexus	ES350		2017-2007
	C350		2011-2006		GS300		2006
	CL550		2010-2007		GS350		2011-2007
	CLK350		2009-2006		GS350		2015-2013
	CLK550		2009-2007		GS450h		2011-2007
	CLS550		2011-2007		GS460		2011-2008
	E280		2007		GX460		2017-2010
	E300		2009-2008		IS250		2015-2006
	E350		2011-2006				
	E550		2011-2007				
	G550		2015-2009				
	GL450		2012-2007				
	GL550		2012-2008				
	GLK350		2012-2010				



94122 (Cont'd)	LFR6AHX-S	Ruthenium HX	94279	FR6AHX-S	Ruthenium HX
Qty per Vehicle: 4-8		Box Qty: 4	Qty per Vehicle: 4-24		Box Qty: 4
Lexus	IS300	2017-2016	Acura	CL	2003-2001
	IS350	2017-2006		CSX	2011-2006
	IS F	2014-2008		EL	2005-2001
	LS460	2017-2007		Integra	2001-1997
	LS600h	2016-2008		MDX	2009-2007
	LX570	2011-2008		NSX	2005-1997
	LX570	2017-2013		RL	2008-2005
	RC300	2017-2016		RSX	2006-2002
	RC350	2017-2015		TL	2008-2002
RX350	2015-2007	TSX	2008-2004		
RX450h	2015-2010	Aston Martin	DB9	2005	
Subaru	Legacy	2017-2010	Audi	A6 Quattro	2006-2000
	Outback	2004-2001		A8 Quattro	2006-1997
	Outback	2017-2010		Allroad Quattro	2005-2003
	Tribeca	2014-2010		S4	2009-2004
Suzuki	Grand Vitara	2012-2009	S6	2003-2002	
	Kizashi	2012-2010	S8	2003-2001	
Toyota	4Runner	2013-2003	BMW	318i	1999-1997
	Avalon	2017-2005		318is	1999-1997
	Camry	2017-2007		318ti	1999-1997
	FJ Cruiser	2013-2007		320i	2005-2001
	Highlander	2016-2008		323Ci	2000
	Land Cruiser	2011-2008		323i	2000-1998
	Land Cruiser	2017-2013		323is	1999-1998
	RAV4	2012-2006		325Ci	2006-2001
	Sequoia	2016-2008		325i	2005-2001
	Sienna	2016-2007		325xi	2005-2001
	Tacoma	2015-2005		328Ci	2000
	Tundra	2017-2005		328i	2000-1997
Venza	2016-2009	328is	1999-1997		
330Ci		2006-2001			
330i		2005-2001			
330xi		2005-2001			
525i		2005-2001			
528i		2000-1997			
530i		2005-2001			
540i		2003-1998			
545i		2005-2004			
550i		2010-2006			
645Ci		2005-2004			
650i		2010-2006			
740i		2001-1998			
740iL		2001-1998			
745i		2005-2002			
745Li		2005-2002			
750i		2008-2006			
750iL		2001-1998			
750Li		2008-2006			
760i		2006-2004			
760Li		2008-2003			
M3		1999-1997			
M5		2003-2000			
X3		2006-2004			
X5		2010-2000			
Z3		2002-1997			
Z4		2005-2003			
Z8		2003-2000			
Cadillac	CTS	2004-2003			
	ELR	2016-2014			
Chevrolet	Aveo	2011-2009			
	Aveo5	2011-2009			
	Cruze	2015-2011			
	Cruze Limited	2016			
	Epica	2006-2004			
	Sonic	2015-2012			
<b>94124</b>	<b>ILKAR7L11</b>	<b>Laser Iridium</b>			
Qty per Vehicle: 4		Box Qty: 4			
Mazda	3	2016-2012			
	3 Sport	2016-2012			
	6	2017-2014			
	CX-3	2017-2016			
	CX-5	2016-2013			
	MX-5 Miata	2017-2016			
<b>94167</b>	<b>DIFR6D13</b>	<b>Laser Iridium</b>			
Qty per Vehicle: 4		Box Qty: 4			
Honda	CR-Z	2016-2011			
<b>94201</b>	<b>SILZKGR8B8S</b>	<b>Laser Iridium</b>			
Qty per Vehicle: 3-6		Box Qty: 4			
BMW	330e	2017			
	330i	2017			
	340i	2017-2016			
	340i GT xDrive	2017			
	340i xDrive	2017-2016			
	430i	2017			
	440i	2017			
	440i Gran Coupe	2017			
	440i xDrive	2017			
	440i xDrive Gran Coupe	2017			
	540i	2017			
	540i xDrive	2017			
	740i	2017-2016			
	740i xDrive	2017			
	M240i	2017			
	M240i xDrive	2017			
	X1	2017-2016			
	Mini	Cooper	2017-2014		
Cooper Clubman		2017-2016			
Cooper Countryman		2017			





94279 (Cont'd)		FR6AHX-S	Ruthenium HX	94279 (Cont'd)		FR6AHX-S	Ruthenium HX
Qty per Vehicle: 4-24			Box Qty: 4	Qty per Vehicle: 4-24			Box Qty: 4
Chevrolet	Tracker		2002-1998	Pontiac	G3		2010-2009
	Volt		2015-2011		G3 Wave		2009
Chrysler	Aspen		2007		Sunrunner		1997
	Sebring		2005-2001		Vibe		2006-2003
Dodge	B1500		1998-1997		Vibe		2010-2009
	B2500		1998-1997	Porsche	911		2002
	B3500		1998-1997		911		2005
	Dakota		2008-1997		Boxster		2004-2001
	Durango		2008-1998		Carrera GT		2005-2004
	Nitro		2008-2007	Rolls-Royce	Park Ward		2002
	Ram 1500		2008-1997		Silver Seraph		2002-1999
	Ram 1500 Van		2003-1999	Scion	tC		2010-2005
	Ram 2500		2002-1998		xB		2012-2008
	Ram 2500 Van		2003-1999	Subaru	Legacy		2012-2010
	Ram 3500		2002-1998		Outback		2012-2010
	Ram 3500 Van		2003-1999		SVX		1997
	Stratus		2005-2001	Suzuki	Esteem		1997
Ford	Probe		1997		Esteem		2002-1999
Geo	Tracker		1997		Grand Vitara		1999
Honda	Accord		2007-2003		Grand Vitara		2008-2006
	Civic		2011-1999		Sidekick		1998-1997
	Civic del Sol		1997		Swift		1997
	CR-V		2009-1999		Swift+		2009
	CR-Z		2016-2011		Verona		2006-2005
	Element		2011-2003		Vitara		1999
	Fit		2014-2007		X-90		1998-1997
Prelude		2001-1997	XL-7			2006-2004	
Jaguar	XJ6		1997	Toyota	4Runner		2009-2003
Jeep	Commander		2008-2006		Avalon		2004-2000
	Grand Cherokee		2008-1999		Camry		2011-2002
	Liberty		2008-2002		Celica		2005-1997
Land Rover	Freelander		2005-2002		Corolla		2006-2005
	Range Rover		2005-2003		Corolla		2012-2009
Lexus	ES300		2003-2002		Highlander		2010-2001
	ES330		2006-2004		Land Cruiser		2007-1998
	GS400		2000-1998		Matrix		2006-2003
	GS430		2007-2001		Matrix		2012-2009
	GX470		2009-2003		RAV4		1997
	HS250h		2012-2010		RAV4		2008-2001
	LS400		2000-1997		Sequoia		2009-2001
	LS430		2006-2001	Sienna		2006-2001	
	LX470		2007-1998	Solara		2008-2002	
	RX300		2003-1999	Tundra		2009-2000	
	RX330		2006-2004	Volkswagen	Phaeton		2006-2004
	RX400h		2008-2006		Touareg		2007-2004
	SC400		2000-1997	Volvo	960		1997
	SC430		2010-2002		S60		2004
Lotus	Elise		2007-2005		S80		2001-1999
	Exige		2006		S80		2010-2007
Mercedes-Benz	C55 AMG		2006-2005		S90		1998-1997
	CL600		2002		V70		2004
	CLK55 AMG		2006-2003		V70		2007-2006
	S600		2002		V90		1998-1997
	SLK55 AMG		2011-2005	XC90		2011-2005	
Mitsubishi	Eclipse		2000	<b>94290</b>	<b>ILZKR8A</b>	<b>Laser Iridium</b>	
	Eclipse		2012-2006	Qty per Vehicle: 6-12			
	Galant		2000-1999	Audi	A8 Quattro	2016-2012	
	Galant		2009-2007	Porsche	Cayenne	2017-2011	
	Lancer		2017-2011	<b>94372</b>	<b>LTR6GP-8</b>	<b>G-Power</b>	
	Outlander Sport		2017-2011	Qty per Vehicle: 4-6			
	Raider		2008-2006	Ford	Edge		2017-2012
	RVR		2017-2011		Escape		2017-2013
Morgan	Aero 8		2005-2004		Expedition		2017-2015
	Nissan	200SX			Explorer		2017-2012
Sentra		1999-1998					



94372 (Cont'd)	LTR6GP-8	G-Power
Qty per Vehicle: 4-6		Box Qty: 4
Ford	F-150	2017-2011
	Fiesta	2017-2011
	Flex	2017-2010
	Focus	2017-2012
	Fusion	2018-2013
	Mustang	2017-2015
	Police Interceptor Sedan	2017-2013
	Police Interceptor Utility	2017-2014
	Special Service Police Sedan	2017-2014
	Taurus	2017-2010
	Transit-150	2017-2015
	Transit-250	2017-2015
	Transit-350	2017-2015
	Transit-350 HD	2017-2015
Jaguar	XE	2017
	XF	2015-2013
Land Rover	Discovery Sport	2016-2015
	LR2	2015-2013
	Range Rover Evoque	2016-2012
Lincoln	MKC	2017-2015
	MKS	2016-2010
	MKT	2017-2010
	MKZ	2017-2013
	Navigator	2017-2015
Mazda	3	2009-2007
	6	2007-2006
	CX-7	2009-2007

94374	LTR6IX	Iridium IX
Qty per Vehicle: 4-6		Box Qty: 4
Buick	Envision	2017-2016
	Regal	2017-2014
Cadillac	ATS	2017-2014
	CT6	2017-2016
	CTS	2017-2014
Chevrolet	Camaro	2017-2016
	Malibu	2017-2014
Ford	Edge	2017-2012
	Escape	2017-2013
	Expedition	2017-2015
	Explorer	2017-2012
	F-150	2017-2011
	Fiesta	2017-2011
	Flex	2017-2010
	Focus	2017-2012
	Fusion	2018-2013
	Mustang	2017-2015
	Police Interceptor Sedan	2017-2013
	Police Interceptor Utility	2017-2014
	Special Service Police Sedan	2017-2014
	Taurus	2017-2010
	Transit-150	2017-2015
	Transit-250	2017-2015
Transit-350	2017-2015	
Transit-350 HD	2017-2015	
Jaguar	XE	2017
	XF	2015-2013
Land Rover	Discovery Sport	2016-2015
	LR2	2015-2013
	Range Rover Evoque	2016-2012
Lincoln	MKC	2017-2015
	MKS	2016-2010
	MKT	2017-2010
	MKZ	2017-2013
	Navigator	2017-2015
Mazda	3	2009-2007

94374 (Cont'd)	LTR6IX	Iridium IX
Qty per Vehicle: 4-6		Box Qty: 4
Mazda	6	2007-2006
	CX-7	2009-2007
94407	ZFR5FGP-E	G-Power
Qty per Vehicle: 6		Box Qty: 4
Chrysler	300	2010-2005
	300M	2004-1999
	Concorde	2004-1998
	Intrepid	2004-1998
	LHS	2001-1999
	Pacifica	2008-2004
	Prowler	2002-2001
	Sebring	2010-2007
	Town & Country	2010-2008
	Dodge	Avenger
Challenger		2010-2009
Charger		2010-2006
Grand Caravan		2010-2008
Intrepid		2004-1998
Journey		2010-2009
Magnum		2008-2005
Nitro		2011-2007
Plymouth	Prowler	1997
	Prowler	2001-1999
Volkswagen	Routan	2010-2009

94460	PFR8S8EG	Laser Platinum
Qty per Vehicle: 6		Box Qty: 4
Audi	A6 Quattro	2017-2009
	A7 Quattro	2017-2012
	A8 Quattro	2017-2013
	Q5	2017-2013
	Q7	2015-2011
	Q7	2017
	S4	2016-2010
	S5	2017-2010
	SQ5	2017-2014
	Porsche	Cayenne
Panamera		2016-2012
Volkswagen	Touareg	2015-2011

94489	ILTR6M9G	Laser Iridium
Qty per Vehicle: 4		Box Qty: 4
Buick	Envision	2017-2016
	Regal	2017-2014
Cadillac	ATS	2017-2014
	CT6	2017-2016
	CTS	2017-2014
Chevrolet	Camaro	2017-2016
	Malibu	2017-2014

94553	ZFR5AIX-11	Iridium IX
Qty per Vehicle: 4-12		Box Qty: 4
Acura	MDX	2006-2003
Honda	Odyssey	2010-2005
	Pilot	2008-2006
	Ridgeline	2008-2006
	Saturn	Vue
Volkswagen	Beetle	2008-2001
	EuroVan	2002-2001
	Golf	2006-2001
	Golf City	2010-2007
	Jetta	2007-2001
	Jetta City	2009-2007
	Phaeton	2006
	Rabbit	2009-2006



94567	TR5AHX	Ruthenium HX	94567 (Cont'd)	TR5AHX	Ruthenium HX
Qty per Vehicle: 4-12		Box Qty: 4	Qty per Vehicle: 4-12		Box Qty: 4
Aston Martin	DB7	2004-2002	Chevrolet	SSR	2006-2003
Buick	Allure	2009-2008		Suburban 1500	2014-2000
	LaCrosse	2009-2008		Suburban 2500	2013-2000
	Lucerne	2011-2006		Suburban 3500 HD	2017-2016
	Rainier	2007-2004		Tahoe	2014-1997
	Skylark	1998-1997		Trailblazer	2009-2006
Cadillac	CTS	2007-2004		Trailblazer EXT	2006-2003
	DeVille	2005-2000	Ford	Crown Victoria	2011-1998
	DTS	2011-2006		E-150	2014-2003
	Eldorado	2002-2000		E-150 Club Wagon	2005-2003
	Escalade	2000-1999		E-150 Econoline	2002-1997
	Escalade	2014-2002		E-150 Econoline Club Wagon	2002-1997
	Escalade ESV	2014-2003		E-250	2014-2003
	Escalade EXT	2013-2002		E-250 Econoline	2002-1997
	Seville	2004-2000		E-350 Club Wagon	2005-2003
	SRX	2009-2004		E-350 Econoline	1998-1997
	STS	2010-2005		E-350 Econoline Club Wagon	2002-1997
	XLR	2009-2004		E-350 Super Duty	2017-1999
	Chevrolet	Astro		2005-1997	E-450 Econoline Super Duty
Avalanche		2013-2007		E-450 Super Duty	2017-2003
Avalanche 1500		2006-2002	E-550 Econoline Super Duty	2002	
Avalanche 2500		2006-2002	E-550 Super Duty	2003	
Blazer		2005-1997	Econoline Super Duty	1999-1997	
C1500		1999-1997	Escape	2012-2001	
C1500 Suburban		1999-1997	Excursion	2005-2000	
C2500		2000-1997	Expedition	2004-1997	
C2500 Suburban		1999-1997	Explorer	2005-2002	
C3500		2000-1997	F53	2004-1999	
C3500HD		2002-2001	F-150	2010-1997	
C4500 Kodiak		2009-2008	F-150 Heritage	2004	
C5500 Kodiak		2009-2008	F-250	1999-1997	
C6500 Kodiak		2009-2008	F-250 Super Duty	2004-1999	
C7500 Kodiak		2009-2008	F-350 Super Duty	2004-1999	
Camaro		2002-1997	F-450 Super Duty	2004-1999	
Camaro		2015-2010	F-550 Super Duty	2004-1999	
Caprice		2017-2011	Five Hundred	2007-2005	
Cavalier		2002-1997	Focus	2011	
Colorado		2012-2009	Freestyle	2007-2005	
Corvette		2013-1997	Fusion	2012-2006	
Express 1500		2014-1997	Mustang	2004-1999	
Express 2500		2017-1997	Taurus	2005-1997	
Express 3500		2017-1997	Transit Connect	2013-2010	
Express 4500		2016-2009	GMC	C1500	1999-1997
Impala		2009-2006		C1500 Suburban	1999-1997
K1500		1999-1997		C2500	2000-1997
K1500 Suburban		1999-1997		C2500 Suburban	1999-1997
K2500		2000-1997		C3500	2000-1997
K2500 Suburban		1999-1997		C3500HD	2002-1997
K3500		2000-1997		C4500 Topkick	2009-2008
Malibu		1999-1997		C5500 Topkick	2009-2008
Monte Carlo		2007-2006		C6500 Topkick	2009-2008
P30		1999-1997		C7500 Topkick	2009-2008
S10		2004-1997		Canyon	2012-2009
Silverado 1500		2013-1999		Envoy	2009-2005
Silverado 1500 Classic		2007		Envoy XL	2006-2003
Silverado 1500 HD		2003-2001		Envoy XUV	2005-2004
Silverado 1500 HD		2006-2005		Jimmy	2005-1997
Silverado 1500 HD Classic		2007		K1500	1999-1997
Silverado 2500		2004-1999		K1500 Suburban	1999-1997
Silverado 2500 HD		2017-2001		K2500	2000-1997
Silverado 2500 HD Classic		2007		K2500 Suburban	1999-1997
Silverado 3500		2006-2001		K3500	2000-1997
Silverado 3500 Classic		2007	P3500	1999-1997	
Silverado 3500 HD		2017-2007	Safari	2005-1997	
SS		2017-2014	Savana 1500	2014-1997	



94567 (Cont'd)		TR5AHX	Ruthenium HX	94705	LKR7BHX	Ruthenium HX	
Qty per Vehicle: 4-12			Box Qty: 4	Qty per Vehicle: 3-8		Box Qty: 4	
GMC	Savana 2500		2017-1997	Dodge	Sprinter 2500	2008-2007	
	Savana 3500		2017-1997		Sprinter 3500	2008-2007	
	Savana 4500		2016-2009	Freightliner	Sprinter 2500	2008-2007	
	Sierra 1500		2013-1999		Sprinter 3500	2008-2007	
	Sierra 1500 Classic		2007	Kia	Soul	2011-2010	
	Sierra 1500 HD		2003-2001		Mercedes-Benz	C230	2009-2006
	Sierra 1500 HD		2006-2005		C250	2015-2010	
	Sierra 1500 HD Classic		2007		C280	2007-2006	
	Sierra 2500		2004-1999		C300	2012-2008	
	Sierra 2500 HD		2017-2001		C350	2011-2006	
	Sierra 2500 HD Classic		2007		CL550	2010-2007	
	Sierra 3500		2006-2001		CLK350	2009-2006	
	Sierra 3500 Classic		2007		CLK550	2009-2007	
	Sierra 3500 HD		2017-2007		CLS550	2011-2007	
	Sonoma		2004-1997		E280	2007	
	Yukon		2014-1997		E300	2009-2008	
	Yukon XL 1500		2014-2000		E350	2011-2006	
Yukon XL 2500		2013-2000	E550		2011-2007		
Hummer	H2		2009-2003	G550	2015-2009		
	H3		2010-2008	GL450	2012-2007		
	H3T		2010-2009	GL550	2012-2008		
Isuzu	Ascender		2006-2003	GLK350	2012-2010		
	Hombre		2000-1997	ML350	2011-2006		
Lincoln	Aviator		2005-2003	ML450	2011-2010		
	Blackwood		2002	ML500	2006-2005		
	Continental		2002-1998	ML550	2011-2008		
	LS		2005-2000	R350	2011-2006		
	Mark VIII		1998-1997	S350	2006		
	Navigator		2004-1998	S400	2013-2010		
	Town Car		2011-1998	S450	2011-2008		
Mazda	Zephyr		2006	S550	2011-2007		
	5		2007-2006	SL550	2012-2007		
	6		2008-2003	SLK250	2015-2012		
	MPV		2006-2002	SLK280	2008-2006		
	Tribute		2006-2001	SLK300	2011-2009		
Mercury	Tribute		2011-2008	SLK350	2011-2005		
	Grand Marquis		2011-1998	Mitsubishi	Outlander	2013-2007	
	Marauder		2004-2003	Smart	Fortwo	2015-2008	
	Mariner		2011-2005	<b>94716</b>	<b>PLKR7B8E</b>	<b>Laser Platinum</b>	
	Milan		2011-2006	Qty per Vehicle: 4		Box Qty: 4	
	Montego		2007-2005	Mercedes-Benz	C250	2015-2012	
	Mountaineer		2005-2002	SLK250	2015-2012		
	Sable		2005-2000	<b>94731</b>	<b>DILKR7C11</b>	<b>Laser Iridium</b>	
Oldsmobile	Achieva		1998-1997	Qty per Vehicle: 6		Box Qty: 4	
	Alero		2001-1999	Mitsubishi	Outlander	2017-2014	
	Aurora		2003-2001	<b>94769</b>	<b>ILZTR6A8G</b>	<b>Laser Iridium</b>	
	Bravada		2001-1997	Qty per Vehicle: 4		Box Qty: 4	
Panoz	Intrigue		2002-1999	Ford	Escape	2016-2013	
	AIV Roadster		2000-1999		Fiesta	2017-2014	
	Esperante		2003-2001		Fusion	2014-2013	
Pontiac	Esperante		2005		Transit Connect	2016-2014	
	Bonneville		2005-2004	<b>94806</b>	<b>LTR6BP13</b>	<b>Laser Platinum</b>	
	Firebird		2002-1997	Qty per Vehicle: 4-8		Box Qty: 4	
	G8		2009-2008	Ford	Edge	2017-2011	
	Grand Am		2001-1997		Explorer	2017-2011	
	Grand Prix		2008-2005		F-150	2017-2011	
	GTO		2006-2004		Flex	2017-2012	
Sunfire		2002-1997		Mustang	2017-2011		
Saab	9-7x		2009-2005		Police Interceptor Sedan	2017-2013	
<b>94702</b>	<b>DF6H-11A</b>		<b>Laser Iridium</b>		Police Interceptor Utility	2017-2013	
Qty per Vehicle: 4			Box Qty: 4		Taurus	2017-2013	
Nissan	Altima		2017-2013		Transit-150	2017-2015	
	Rogue		2017-2014		Transit-250	2017-2015	
					Transit-350	2017-2015	



94806 (Cont'd)		LTR6BP13	Laser Platinum	95125 (Cont'd)		LFER7BHX	Ruthenium HX	
Qty per Vehicle: 4-8		Box Qty: 4		Qty per Vehicle: 4		Box Qty: 4		
Ford	Transit-350 HD	2017-2015		Volkswagen	Golf	2017-2015		
Lincoln	Continental	2017			Golf Alltrack	2017		
	MKS	2016-2014			Golf R	2017-2015		
	MKT	2017-2012			Golf SportWagen	2017-2015		
	MKX	2017-2011			GTI	2017-2015		
	MKZ	2016-2013			Jetta	2017-2013		
Mazda	MX-5 Miata	2015-2006			Passat	2017-2014		
94833		PLFER7A8EG	Laser Platinum	95159		FR6BHX-S	Ruthenium HX	
Qty per Vehicle: 4		Box Qty: 4		Qty per Vehicle: 4-24		Box Qty: 4		
Audi	A3	2017-2015		Audi	A4	2001-1997		
	A3 Quattro	2017-2015				A4 Quattro	2001-1997	
	A4	2017				A6	2001-1997	
	A4 allroad	2017				A6 Quattro	2001-1997	
	A4 Quattro	2017				Cabriolet	1998-1997	
	A6	2017-2016			Bentley	Arnage	1999	
	A6 Quattro	2017-2016		BMW	540i	1997		
	allroad	2016				740i	1997	
	Q7	2017				740iL	1997	
	S3	2017-2015				840Ci	1997	
	TT Quattro	2017-2016		Chevrolet	Aveo	2008-2004		
Volkswagen	Beetle	2017-2013				Aveo5	2008-2006	
	Golf	2017-2015				Cobalt	2007-2005	
	Golf Alltrack	2017				Metro	2001-1998	
	Golf R	2017-2015				Optra	2007-2004	
	Golf SportWagen	2017-2015				Sonic	2017-2016	
	GTI	2017-2015				Tracker	2000-1999	
	Jetta	2017-2013		Chrysler	Cirrus	2000		
	Passat	2017-2014				Crossfire	2006-2005	
					Neon	2002-2000		
					Sebring	1999-1997		
Qty per Vehicle: 1		Box Qty: 4		Daewoo	Lanos	2002-1999		
Ford	F-150	2018				Leganza	2002-1999	
	Mustang	2018				Nubira	2002-1999	
94940		ILKAR7C10	Laser Iridium	Dodge				
Qty per Vehicle: 8		Box Qty: 4			Avenger	1999-1997		
Jaguar	F-Type	2017-2014			Dakota	2010-2009		
	XF	2015-2010			Durango	2009		
	XFR	2015-2010			Neon	2005-1997		
	XFR-S	2015-2013			Nitro	2011-2009		
	XJ	2016-2010			Ram 1500	2010-2009		
	XJR	2016-2014			Ram 2500	2003-1997		
	XK	2015-2010			Ram 3500	2003-1997		
	XKR	2015-2010			Stratus	2005-1997		
	XKR-S	2015-2012			SX 2.0	2005-2003		
Land Rover	LR4	2013-2010		Eagle	Talon	1998-1997		
	Range Rover	2016-2010		Isuzu	Rodeo	2003		
	Range Rover Sport	2016-2010				Rodeo Sport	2003	
95112		ILZKAR8H8S	Laser Iridium	Jaguar	Vanden Plas	2003		
Qty per Vehicle: 4		Box Qty: 4			XJR	2003-1998		
Honda	Civic	2017-2016			XKR	2003		
95125		LFER7BHX	Ruthenium HX	Jeep	Commander	2010-2009		
Qty per Vehicle: 4		Box Qty: 4			Grand Cherokee	2010-2009		
Audi	A3	2017-2015			Liberty	2012-2009		
	A3 Quattro	2017-2015		Kia	Rio	2005-2001		
	A4	2017				Sephia	2001-1998	
	A4 allroad	2017				Spectra	2004-2000	
	A4 Quattro	2017				Sportage	2002-1997	
	A6	2017-2016			Land Rover	Discovery	2004-1999	
	A6 Quattro	2017-2016			Lexus	ES300	2001-1997	
	allroad	2016					GS300	2005-2001
	Q7	2017				IS300	2005-2001	
	S3	2017-2015		Lotus	Esprit	2003-1997		
	TT Quattro	2017-2016		Maybach	57	2012-2003		
	Volkswagen	Beetle	2017-2013			62	2012-2003	
				Mazda	Protege	2003		
				Mercedes-Benz	B200	2011-2006		



95159 (Cont'd)	FR6BHX-S	Ruthenium HX
Qty per Vehicle: 4-24		Box Qty: 4
Mercedes-Benz	C32 AMG	2004-2002
	C230	2000-1999
	C230	2002
	CL65 AMG	2006-2005
	CL65 AMG	2014-2008
	CL600	2014-2003
	G65 AMG	2017-2016
	Maybach S600	2017-2016
	S65 AMG	2013-2006
	S65 AMG	2017-2015
	S600	2013-2003
	S600	2017-2015
	SL65 AMG	2011-2005
	SL65 AMG	2017-2013
	SL600	2011-2004
SLK32 AMG	2004-2002	
SLK230	2004-2001	
Mini	Cooper	2008-2002
Mitsubishi	3000GT	1999-1997
	Eclipse	1999-1997
	Eclipse	2005-2003
	Endeavor	2008-2004
	Endeavor	2011-2010
	Galant	2006-2004
	Lancer	2010-2008
	Montero	2006-2003
	Montero Sport	1998-1997
	Raider	2009
Nissan	Frontier	2004-2001
	Xterra	2004-2002
Plymouth	Breeze	2000-1997
	Neon	2001-1997
Pontiac	Wave	2008-2005
	Wave5	2007-2005
Porsche	911	1997
	911	2004-1999
	911	2009-2007
	Boxster	2002-1997
	Cayenne	2006-2003
Ram	1500	2013-2011
	Dakota	2011
Rolls-Royce	Phantom	2013-2004
Saab	9-2X	2005
	9-3	2011-2004
	9-3X	2011-2010
	900	1997
	9000	1997
Saturn	Ion	2007-2004
Subaru	Baja	2003
	Forester	2004-1999
	Impreza	2005-1997
	Legacy	2003-1997
	Outback	2003-2000
Suzuki	Esteem	2001-1998
	Forenza	2008-2004
	Reno	2008-2005
	Swift	2001-1998
	Swift+	2008-2004
	Verona	2004
	Vitara	2002-1999
Toyota	Avalon	1999-1997
	Camry	2001-1997
	Previa	1997
	RAV4	2000-1998
	Sienna	2000-1998

95159 (Cont'd)	FR6BHX-S	Ruthenium HX
Qty per Vehicle: 4-24		Box Qty: 4
Toyota	Solara	2003-1999
	Supra	1998-1997
Volkswagen	Beetle	2001-1998
	Beetle	2003
	Golf	2001-1999
	Jetta	2001-1999
	Passat	2005-1998
Volvo	850	1997
	C70	2004-1998
	S40	2004-2000
	S60	2009-2001
	S70	2000-1998
	S80	2006-1999
	V40	2004-2000
	V70	2007-1998
	XC70	2007-2003
	XC90	2006-2003
<b>95248 SILZKGR8C8S Laser Iridium</b>		
Qty per Vehicle: 3		Box Qty: 4
BMW	i8	2017-2014
<b>95264 DILKR6D11G Laser Iridium</b>		
Qty per Vehicle: 4		Box Qty: 4
Mitsubishi	Outlander	2017-2014
<b>95332 ZFR5FIX-E Iridium IX</b>		
Qty per Vehicle: 4		Box Qty: 4
Chrysler	200	2014-2011
	Sebring	2010-2008
Dodge	Avenger	2014-2008
	Caliber	2010-2008
	Journey	2010-2009
Jeep	Compass	2009
	Patriot	2009
<b>95350 DILZKR7B11G Laser Iridium</b>		
Qty per Vehicle: 6		Box Qty: 4
Acura	MDX	2017-2014
	RLX	2017-2014
	TLX	2018-2015
Honda	Odyssey	2018
	Pilot	2017-2016
	Ridgeline	2018-2017
<b>95369 SILTR6A7G Laser Iridium</b>		
Qty per Vehicle: 4		Box Qty: 4
Mazda	3	2013-2010
	CX-7	2012-2010
<b>95605 LTR7BHX Ruthenium HX</b>		
Qty per Vehicle: 6		Box Qty: 4
Cadillac	ATS	2017-2016
	CT6	2017-2016
	CTS	2017-2014
	XTS	2017-2014
Ford	Edge	2017-2015
	F-150	2017-2015
	Fusion	2018-2017
Lincoln	Continental	2017
	MKX	2017-2016
	MKZ	2017
<b>95609 IFR6Z7G Laser Iridium</b>		
Qty per Vehicle: 4		Box Qty: 4
Cadillac	ELR	2016-2014
Chevrolet	Cruze	2015-2011
	Cruze Limited	2016
	Sonic	2017-2012
	Volt	2015-2011





95660		ILZKAR8J8SY	Laser Iridium	95839 (Cont'd)		FR5AHX	Ruthenium HX
Qty per Vehicle: 4		Box Qty: 4		Qty per Vehicle: 4-24		Box Qty: 4	
Honda	Civic	2017		Chrysler	Crossfire	2008-2004	
	CR-V	2017			Sebring	2000-1997	
					Sebring	2007	
95705		SILKR8B8DS	Laser Iridium	Sebring	2010-2009		
Qty per Vehicle: 4		Box Qty: 4		Dodge	Avenger	2000-1997	
Honda	Civic	2015-2012			Avenger	2014-2008	
					Caliber	2012-2007	
95710		DILZKR7B11GS	Laser Iridium		Dakota	2007-2000	
Qty per Vehicle: 4		Box Qty: 4			Journey	2017-2009	
Acura	ILX	2015-2013			Ram 3500	1997	
Honda	Accord	2012-2008			Stratus	2000-1997	
	Civic	2015-2012					
	HR-V	2018-2016		Geo	Prizm	1997	
95712		LZFR6AP11GS	Laser Platinum	Honda	Accord	2002-1997	
Qty per Vehicle: 6		Box Qty: 4		Civic	2000-1997		
BMW	128i	2013-2010		Civic	2005-2003		
	323i	2011-2010		Civic del Sol	1997		
	328i	2013-2010		CR-V	1998-1997		
	328i xDrive	2013-2010		Odyssey	2004-1997		
	528i	2011		Passport	2002-1997		
	X3	2012-2010		Pilot	2005-2003		
	X5	2010					
	Z4	2011-2010					
95770		ILZKBR7B8DG	Laser Iridium	Hyundai	Accent	2011-2006	
Qty per Vehicle: 4		Box Qty: 4		Azera	2011-2006		
Mini	Cooper	2015-2007		Entourage	2010-2007		
	Cooper Countryman	2016-2011		Santa Fe	2009-2007		
	Cooper Paceman	2016-2013		Sonata	2010-2006		
95822		ILTR7N8	Laser Iridium	Veracruz	2012-2007		
Qty per Vehicle: 6		Box Qty: 4		Infiniti	G20	2002-1999	
Ford	Edge	2017-2015		I30	2001-1997		
	F-150	2017-2015		J30	1997		
	Fusion	2018-2017		Q45	2001-1997		
Lincoln	Continental	2017		QX4	2000-1997		
	MKX	2017-2016		Isuzu	Amigo	2000-1998	
	MKZ	2017		Axiom	2003-2002		
95830		LKAR6AGP	G-Power	Oasis	1999-1997		
Qty per Vehicle: 4		Box Qty: 4		Rodeo	2004-1997		
Chevrolet	City Express	2017-2015		Rodeo Sport	2003-2001		
Nissan	Altima	2013-2007		Trooper	2002-1997		
	Cube	2014-2009		VehiCROSS	2001-1999		
	Frontier	2017-2005		Jaguar	S-Type	2002-2000	
	Micra	2017-2015		Vanden Plas	1999-1997		
	NV200	2017-2013		Vanden Plas	2005-2003		
	Rogue	2013-2008		XF	2010		
	Rogue Select	2015-2014		XJ8	2009-1998		
	Sentra	2017-2007		XK	2009-2007		
	Versa	2017-2007		XK8	2006-1997		
	Versa Note	2017-2014		Jeep	Compass	2017-2007	
95839		FR5AHX	Ruthenium HX	Patriot	2017-2007		
Qty per Vehicle: 4-24		Box Qty: 4		Kia	Amanti	2009-2007	
Acura	CL	1999-1997		Magentis	2008-2007		
	CL	2003-2001		Optima	2008-2006		
	EL	2000-1997		Rio	2011-2006		
	Integra	2001-1997		Rio5	2011-2006		
	MDX	2002-2001		Rondo	2008-2007		
	RL	2004-1997		Sedona	2012-2006		
	SLX	1999-1997		Sedona	2014		
	TL	2003-1997		Sephia	1997		
BMW	850Ci	1997		Sorento	2009-2007		
Cadillac	Catera	2001-1999		Land Rover	LR3	2009-2005	
Chevrolet	Prizm	2002-2000		Range Rover	2009-2006		
	Tracker	2004-2001		Range Rover Sport	2009-2006		
Chrysler	200	2014-2011		Lexus	GS300	1997	
	Cirrus	2000-1997		LX450	1997		
				SC300	1997		
				Lincoln	LS	2002-2000	
				Mazda	2	2014-2011	



95839 (Cont'd)	FR5AHX	Ruthenium HX
Qty per Vehicle: 4-24		Box Qty: 4
Mazda	626	1997
	Millenia	2002-1997
	MPV	1998-1997
	MX-6	1997
	Protege	1998-1997
Mercedes-Benz	C43 AMG	2000-1998
	C240	2005-2001
	C280	2000-1998
	C320	2005-2001
	CL55 AMG	2002-2001
	CL500	2006-1998
	CL600	1999-1998
	CL600	2001
	CLK55 AMG	2002-2001
	CLK320	2005-1998
	CLK430	2003-1999
	CLK500	2006-2003
	CLS500	2006
	E55 AMG	2002-1999
	E320	2005-1998
	E420	1997
	E430	2002-1998
	E500	2006-2003
	G55 AMG	2004-2003
	G500	2008-2002
	ML55 AMG	2003-2000
	ML320	2003-1998
	ML350	2005
	ML430	2001-1999
	ML500	2004-2002
	ML500	2007
	R500	2007-2006
	S55 AMG	2002-2001
	S420	1999-1997
	S430	2006-2000
	S500	2006-1997
	S600	1999-1997
	S600	2001
SL500	2006-1997	
SL600	2002-1997	
SLK320	2004-2001	
Mercury	Villager	2002-1997
Mitsubishi	Diamante	2004-1997
	Eclipse	2005-2001
	Galant	1998-1997
	Galant	2003-2001
	Lancer	2017-2009
	Montero Sport	1999-1997
	Outlander	2013-2008
	Outlander Sport	2017-2015
	Raider	2007-2006
	RVR	2017-2015
Nissan	240SX	1998-1997
	Altima	2001-1997
	Frontier	2004-1998
	Maxima	2001-1997
	Pathfinder	2000-1997
	Quest	2002-1997
	Sentra	2001-1997
	Xterra	2004-2000
Pontiac	Vibe	2008-2003
Saturn	Astra	2009-2008
	L300	2005-2001
	LS2	2000
	LW2	2000

95839 (Cont'd)	FR5AHX	Ruthenium HX
Qty per Vehicle: 4-24		Box Qty: 4
Saturn	LW300	2003-2001
	Vue	2003-2002
Scion	xA	2006-2004
	xB	2006-2004
	xB	2015-2012
Suzuki	Aerio	2007-2002
	Grand Vitara	2005-2000
	SX4	2009-2007
	Vitara	2004-2000
	XL-7	2003-2002
Toyota	4Runner	2000
	Celica	1997
	Celica	2005-2000
	Corolla	1997
	Corolla	2008-2000
	Corolla	2012
	Echo	2005-2000
	Land Cruiser	1997
	Matrix	2008-2003
	Matrix	2013-2012
	MR2 Spyder	2005-2000
	Prius	2009-2001
	Supra	1997
	T100	1997
	Tacoma	1997
	Tacoma	2004-2001
Yaris	2017-2006	
Volkswagen	Cabrio	2001-1997
	EuroVan	2001
	EuroVan	2003
	Golf	1998-1997
	Jetta	1999-1997
<b>95853 LTR6A13 Laser Iridium</b>		
Qty per Vehicle: 8		Box Qty: 4
Ford	F-150	2014-2011
	Mustang	2014-2011
<b>95875 SILZKFR8D7S Laser Iridium</b>		
Qty per Vehicle: 4-8		Box Qty: 4
Mercedes-Benz	B250	2014
	C43 AMG	2017
	C400	2015
	C450 AMG	2016
	CLA45 AMG	2017-2014
	CLS400	2016-2015
	E43 AMG	2017
	E400	2017-2015
	G550	2017-2016
	GL450	2016-2015
	GLA45 AMG	2017-2015
	GLC43 AMG	2017
	GLE43 AMG	2017
	GLE400	2017-2016
	GLE450 AMG	2016
	GLE550e	2017-2016
	GLS450	2017
ML400	2015	
S550e	2017-2015	
SL400	2016-2015	
SL450	2017	
SLC43 AMG	2017	
<b>95983 LKR7BGP-8 G-Power</b>		
Qty per Vehicle: 3-8		Box Qty: 4
Dodge	Sprinter 2500	2008-2007
	Sprinter 3500	2008-2007



95983 (Cont'd)		LKR7BGP-8	G-Power	96355 (Cont'd)		LFR5AHX	Ruthenium HX
Qty per Vehicle: 3-8			Box Qty: 4	Qty per Vehicle: 3-16			Box Qty: 4
Freightliner	Sprinter 2500		2008-2007	Dodge	Ram 1500		2010-2009
	Sprinter 3500		2008-2007		Ram 2500		2010-2009
Kia	Soul		2011-2010		Ram 3500		2009
Mercedes-Benz	C230		2009-2006	Fiat	500X		2017-2016
	C250		2012-2010	Hyundai	Equus		2011
	C280		2007-2006		Genesis		2012-2009
	C300		2012-2008		Santa Fe		2012-2007
	C350		2011-2006		Sonata		2010-2009
	CL550		2010-2007		Tucson		2013-2010
	CLK350		2009-2006	Infiniti	FX35		2008-2003
	CLK550		2009-2007		FX45		2008-2003
	CLS550		2011-2007		G35		2007-2003
	E280		2007		I35		2004-2002
	E300		2009-2008		M35		2008-2006
	E350		2011-2006		M45		2004-2003
	E550		2011-2007		M45		2010-2006
	G550		2015-2009		Q45		2006-2002
	GL450		2012-2007		QX4		2003-2001
	GL550		2012-2008		QX56		2010-2004
	GLK350		2012-2010	Jeep	Cherokee		2017-2014
	ML350		2011-2006		Commander		2010-2009
	ML450		2011-2010		Grand Cherokee		2017-2009
	ML500		2006-2005		Renegade		2017-2015
	ML550		2011-2008		Kia	Borrego	
	R350		2011-2006	Forte			2013-2010
	S350		2006	Forte5			2013-2012
	S400		2013-2010	Forte Koup			2013-2010
	S450		2011-2008	Magentis			2010-2007
	S550		2011-2007	Optima			2010-2006
	SL550		2012-2007	Rondo			2012-2007
	SLK280		2008-2006	Sorento			2013-2011
	SLK300		2011-2009	Sportage		2013-2011	
	SLK350		2011-2005	Mitsubishi	Mirage		2015-2014
Mitsubishi	Outlander		2013-2007	Nissan	350Z		2006-2003
Smart	Fortwo		2015-2008		Altima		2006-2002
<b>96002 LKR6BGP-E G-Power</b>		<b>G-Power</b>			Armada		2015-2005
Qty per Vehicle: 4			Box Qty: 4		Frontier		2017-2005
Hyundai	Veloster		2014-2013		Maxima		2008-2002
Kia	Forte5		2016-2014		Murano		2007-2003
	Forte Koup		2016-2014		NV1500		2017-2012
<b>96024 ILKAR8H6 Laser Iridium</b>		<b>Laser Iridium</b>			NV2500		2017-2012
Qty per Vehicle: 4			Box Qty: 4		NV3500		2017-2012
Subaru	Forester		2017-2014		Pathfinder		2012-2001
	WRX		2018-2015		Pathfinder Armada		2004
<b>96329 ILTR5L11 Laser Iridium</b>		<b>Laser Iridium</b>			Quest		2009-2004
Qty per Vehicle: 4			Box Qty: 4		Sentra		2006-2000
Buick	Envision		2017		Titan		2015-2004
Cadillac	ATS		2017-2013		Xterra		2015-2005
Chevrolet	Colorado		2016-2015		X-Trail		2006-2005
	Impala		2017-2014		Ram	1500	
	Malibu		2015-2013	2500			2017-2011
	Malibu Limited		2016	3500			2017-2011
GMC	Acadia		2017	4500			2014
	Canyon		2016-2015	5500			2014
<b>96355 LFR5AHX Ruthenium HX</b>		<b>Ruthenium HX</b>		ProMaster City		2017-2015	
Qty per Vehicle: 3-16			Box Qty: 4	Scion	tC		2016-2011
Chrysler	200		2017-2015	Suzuki	Equator		2012-2009
	300		2017-2009		SX4		2013-2010
	Aspen		2009		SX4 Crossover		2012
	Dodge	Challenger		2017-2009	Toyota	4Runner	
Charger			2017-2009	Camry			2017-2010
Dart			2016-2013	FJ Cruiser			2014-2013
Durango			2009	Highlander			2017-2009
Durango			2017-2011	RAV4			2017-2009
						Sienna	



96355 (Cont'd)	LFR5AHX	Ruthenium HX	
Qty per Vehicle: 3-16		Box Qty: 4	
Toyota	Tundra	2014-2013	
	Venza	2016-2009	
96358	LKR7AHX-S	Ruthenium HX	
Qty per Vehicle: 4-8		Box Qty: 4	
Acura	ILX	2015-2013	
	MDX	2017-2010	
	RDX	2018-2013	
	RL	2012-2009	
	RLX	2017-2014	
	TL	2014-2009	
	TLX	2018-2015	
	TSX	2014-2009	
Chrysler	ZDX	2013-2010	
	200	2017-2011	
Dodge	300	2017-2011	
	Town & Country	2016-2011	
	Avenger	2014-2011	
Genesis	Challenger	2017-2011	
	Charger	2017-2011	
	Durango	2015-2011	
	Grand Caravan	2017-2011	
	Journey	2017-2011	
	G80	2018-2017	
	Honda	Accord	2017-2008
		Accord Crosstour	2011-2010
		Civic	2015-2012
		Crosstour	2015-2012
CR-V		2014-2010	
HR-V		2018-2016	
Odyssey		2018-2008	
Pilot		2017-2009	
Ridgeline		2014-2009	
Ridgeline		2018-2017	
Hyundai	Azera	2017-2012	
	Elantra	2016-2012	
	Elantra Coupe	2014-2013	
	Elantra GT	2015-2013	
	Equus	2016-2012	
	Genesis	2016-2012	
	Genesis Coupe	2016-2010	
	Santa Fe	2018-2010	
	Santa Fe XL	2018-2013	
	Sonata	2018-2015	
Tucson	2017-2014		
Jeep	Cherokee	2017-2014	
	Grand Cherokee	2015-2011	
	Wrangler	2017-2012	
Kia	Cadenza	2017-2014	
	Forte	2017-2014	
	Forte5	2017-2014	
	Forte Koup	2016-2014	
	K900	2017-2015	
	Optima	2017-2016	
	Rondo	2017-2014	
	Sedona	2012-2011	
	Sedona	2017-2014	
	Sorento	2017-2011	
	Soul	2017-2012	
	Sportage	2017-2016	
Mitsubishi	Outlander	2017-2014	
Ram	1500	2017-2013	
	C/V	2015-2012	
	ProMaster 1500	2017-2014	
	ProMaster 2500	2017-2014	
	ProMaster 3500	2017-2014	

96358 (Cont'd)	LKR7AHX-S	Ruthenium HX	
Qty per Vehicle: 4-8		Box Qty: 4	
Volkswagen	Routan	2014-2011	
96361	PMR8C-H	Laser Platinum	
Qty per Vehicle: 8		Box Qty: 4	
Maserati	Gran Turismo	2011-2008	
	Quattroporte	2011-2007	
96457	FR5BHx	Ruthenium HX	
Qty per Vehicle: 4-8		Box Qty: 4	
Bentley	Arnage	2009-2000	
	Azure	2003-1997	
	Azure	2008-2006	
	Brooklands	1998-1997	
	Continental	2003-1997	
	Turbo R	1998-1997	
	Cadillac	Catera	1998-1997
	Chevrolet	Prizm	1999-1998
Chrysler	Sebring	2005-2001	
Dodge	Caliber	2009-2008	
Hyundai	Accent	2005-1997	
	Elantra	2012-1997	
	Santa Fe	2006-2001	
	Sonata	2005-1999	
	Tiburon	2001-1997	
	Tiburon	2008-2003	
	Tucson	2009-2005	
	XG300	2001	
	XG350	2005-2002	
	Isuzu	Amigo	2000-1998
Jaguar	Rodeo	2002-1998	
	Rodeo Sport	2002-2001	
	S-Type	2008-2003	
Kia	Super V8	2009-2005	
	Vanden Plas	2002-2000	
	Vanden Plas	2009-2006	
	XF	2009	
	XJR	1997	
	XJR	2009-2004	
	XKR	2002-2000	
	XKR	2009-2004	
	Amanti	2006-2004	
	Magentis	2006-2001	
Land Rover	Optima	2006-2001	
	Sedona	2005-2002	
	Sorento	2006-2003	
	Soul	2011-2010	
	Spectra	2009-2004	
	Spectra5	2009-2005	
	Sportage	2010-2005	
	Range Rover	2009-2006	
	Range Rover Sport	2009-2006	
	Lexus	GS300	2000-1998
Mazda	SC300	2000-1998	
	626	2002-1998	
	Miata	1997	
	Miata	2005-1999	
	Millenia	2002-1997	
	Protege	2003-1999	
	Protege5	2003-2002	
	Mercedes-Benz	C36 AMG	1997
	C230	1998-1997	
	C280	1997	
E320	1997		
S320	1999-1997		
SL320	1997		
SLK230	2000-1998		



96457 (Cont'd)		FR5BHX	Ruthenium HX	
Qty per Vehicle: 4-8			Box Qty: 4	
Mitsubishi	Eclipse		2005-1997	
	Galant		2003-1999	
	Lancer		2007-2002	
	Mirage		2002-1997	
	Montero		2002-1997	
	Montero Sport		2004-1999	
	Outlander		2003	
Rolls-Royce	Corniche		2001-2000	
	Silver Dawn		1997	
Saab	9-2X		2006-2005	
Saturn	SC2		2002-1997	
	SL2		2002-1997	
	SW2		2001-1997	
Subaru	Baja		2006-2004	
	Forester		1998	
	Forester		2010-2005	
	Impreza		1998	
	Impreza		2011-2005	
	Legacy		1999-1997	
	Legacy		2009-2004	
	Outback		2009-2004	
Toyota	4Runner		2002-1997	
	Corolla		1999-1998	
	Paseo		1999-1997	
	Supra		1998	
	T100		1998-1997	
	Tacoma		2004-1997	
	Tercel		1999-1997	
	Tundra		2004-2000	
				2004
Volkswagen	Beetle		1997	
	EuroVan		2000-1999	
	Golf		1999-1997	
	Golf		2002-2001	
	Jetta		2002-1997	
	Passat		1997	
				2004
				1997
96509		ILZKAR7E11S	Laser Iridium	
Qty per Vehicle: 4			Box Qty: 4	
Honda	Accord		2015-2014	
	Accord		2017	
96588		LTR6DI-8	Laser Iridium	
Qty per Vehicle: 4			Box Qty: 4	
Ford	Edge		2014-2013	
	Escape		2017-2013	
	Explorer		2017-2014	
	Focus		2017-2013	
	Fusion		2016-2013	
	Mustang		2017-2015	
	Special Service Police Sedan		2017-2014	
	Taurus		2017-2014	
Lincoln	MKC		2017-2015	
	MKT		2016-2013	
	MKZ		2017-2013	
96621		ILTR6G8G	Laser Iridium	
Qty per Vehicle: 4-6			Box Qty: 4	
Buick	Allure		2005	
	LaCrosse		2005	
	Rendezvous		2006-2004	
Cadillac	CTS		2007-2004	
	SRX		2005-2004	
	STS		2005	
Ford	Edge		2013-2012	
	Edge		2017-2015	
	Explorer		2013-2012	

96621 (Cont'd)		ILTR6G8G	Laser Iridium	
Qty per Vehicle: 4-6			Box Qty: 4	
Ford	Focus		2017-2016	
	Fusion		2018-2017	
	Taurus		2013	
			2017	
Jaguar	XE		2015-2013	
	XF		2015-2017	
Land Rover	Discovery Sport		2016-2015	
	LR2		2015-2013	
	Range Rover Evoque		2016-2012	
Suzuki	Grand Vitara		2010-2009	
	XL-7		2009-2007	
96779		ILFR5T11	Laser Iridium	
Qty per Vehicle: 4-16			Box Qty: 4	
Ram	2500		2015-2014	
	3500		2015-2014	
	4500		2014	
	5500		2014	
Scion	tC		2016-2011	
Toyota	4Runner		2017-2013	
	Camry		2017-2010	
	FJ Cruiser		2014-2013	
	Highlander		2017-2009	
	RAV4		2017-2009	
	Sienna		2013-2011	
	Tundra		2014-2013	
Venza		2016-2009		
96807		ZFR5FIX-11E	Iridium IX	
Qty per Vehicle: 6			Box Qty: 4	
Chrysler	300		2010-2005	
	300M		2004-1999	
	Concorde		2004-1998	
	Intrepid		2004-1998	
	LHS		2001-1999	
	Pacifica		2008-2004	
	Prowler		2002-2001	
	Sebring		2010-2007	
	Town & Country		2010-2008	
				2010-2008
Dodge	Avenger		2010-2008	
	Challenger		2010-2009	
	Charger		2010-2006	
	Grand Caravan		2010-2008	
	Intrepid		2004-1998	
	Journey		2010-2009	
	Magnum		2008-2005	
	Nitro		2011-2007	
	Plymouth	Prowler		1997
		Prowler		2001-1999
Volkswagen	Routan		2010-2009	
96870		ILTR6H8G	Laser Iridium	
Qty per Vehicle: 4			Box Qty: 4	
Ford	Fiesta		2017-2011	
96957		DILKR7B6	Laser Iridium	
Qty per Vehicle: 4			Box Qty: 4	
Mitsubishi	Lancer		2015-2011	
96964		DILKAR7H11GS	Laser Iridium	
Qty per Vehicle: 4			Box Qty: 4	
Acura	ILX		2017-2016	
	TLX		2018-2015	
Honda	CR-V		2017-2015	
97100		TR4BHX	Ruthenium HX	
Qty per Vehicle: 4-6			Box Qty: 4	
Buick	Allure		2009-2005	
	Century		2005-1997	
	LaCrosse		2009-2005	



97100 (Cont'd)	TR4BHX	Ruthenium HX
Qty per Vehicle: 4-6		Box Qty: 4
Buick	LeSabre	2005-1997
	Lucerne	2008-2006
	Park Avenue	2005-1997
	Regal	2004-1997
	Rendezvous	2007-2002
	Riviera	1999-1997
	Skylark	1998-1997
Chevrolet	Terraza	2006-2005
	Camaro	2002-1997
	Equinox	2009-2005
	Express 1500	2014-2008
	Impala	2005-2000
	Lumina	2001-1997
	Malibu	2006-1997
	Monte Carlo	2005-1997
	S10	1998
	S10	2002
	Silverado 1500	2013-2007
	Uplander	2006-2005
	Venture	2005-1997
	Ford	F-150
GMC	Savana 1500	2014-2008
	Sierra 1500	2013-2007
Oldsmobile	88	1999-1997
	Achieva	1998-1997
	Alero	2004-1999
	Cutlass	1999-1997
	Cutlass Supreme	1997
	Intrigue	1999-1998
	LSS	1999-1997
	Regency	1998-1997
	Silhouette	2004-1997
	Pontiac	Aztek
Bonneville		2005-1997
Firebird		2002-1997
G6		2006-2005
Grand Am		2005-1997
Grand Prix		2008-1997
Montana		2006-1999
Torrent		2009-2006
Trans Sport		1999-1997
Saturn		Relay
97138	ZFR6AIX-11S	Iridium IX
Qty per Vehicle: 4-6		Box Qty: 4
Acura	CSX	2011-2006
	MDX	2009-2007
	RL	2008-2005
	RSX	2006-2002
	TL	2008-2004
	TSX	2008-2004
Honda	Accord	2007-2003
	Civic	2011-2002
	CR-V	2009-2002
	Element	2011-2003
	Fit	2014-2007
97177	LTR6CI-8	Laser Iridium
Qty per Vehicle: 6		Box Qty: 4
Ford	Expedition	2017-2015
	Explorer	2017-2013
	F-150	2016-2011
	Flex	2017-2010
	Police Interceptor Sedan	2017-2013
	Police Interceptor Utility	2017-2014
	Taurus	2017-2010

97177 (Cont'd)	LTR6CI-8	Laser Iridium	
Qty per Vehicle: 6		Box Qty: 4	
Ford	Transit-150	2017-2015	
	Transit-250	2017-2015	
	Transit-350	2017-2015	
	Transit-350 HD	2017-2015	
Lincoln	MKS	2016-2010	
	MKT	2017-2010	
	Navigator	2017-2015	
97218	DILFR7B10G	Laser Iridium	
Qty per Vehicle: 6		Box Qty: 4	
Saab	9-4X	2011	
	9-5	2011-2010	
97287	ITR5H13	Laser Iridium	
Qty per Vehicle: 4-12		Box Qty: 4	
Aston Martin	DB7	2004	
Buick	Century	1993-1986	
	Electra	1987-1986	
	LeSabre	1988-1986	
	Lucerne	2011-2006	
	Riviera	1987-1986	
	Roadmaster	1996-1994	
	Skylark	1993-1986	
	Skylark	1998-1995	
	Somerset	1987-1986	
	Somerset Regal	1985	
	Cadillac	Allante	1993-1987
		Commercial Chassis	1990-1985
		DeVille	1990-1982
DeVille		2005-1994	
DTS		2011-2006	
Eldorado		1990-1982	
Eldorado		2002-1993	
Fleetwood		1990-1982	
Fleetwood		1996-1994	
Seville		1990-1982	
Seville		2004-1993	
SRX		2009-2007	
STS		2010-2007	
XLR		2009-2007	
Chevrolet		Blazer	1997-1996
	C1500	1997-1996	
	C1500 Suburban	1996	
	C2500	1996	
	C2500 Suburban	1996	
	C3500	1996	
	C3500HD	2002-2001	
	Camaro	1997-1993	
	Caprice	1996-1994	
	Cavalier	2002-1995	
	Corvette	1996-1992	
	Express 1500	1997-1996	
	Express 2500	1997-1996	
	Express 3500	1996	
	Impala	1996-1994	
K1500	1997-1996		
K1500 Suburban	1996		
K2500	1996		
K2500 Suburban	1996		
K3500	1996		
Lumina	1995-1991		
Malibu	1999-1997		
Monte Carlo	1995		
P30	1999-1996		
S10	1997-1996		
Tahoe	1996		





97287 (Cont'd)	ITR5H13	Laser Iridium	97287 (Cont'd)	ITR5H13	Laser Iridium	
Qty per Vehicle: 4-12		Box Qty: 4	Qty per Vehicle: 4-12		Box Qty: 4	
Eagle	Medallion	1989-1988	GMC	K2500 Suburban	1996	
Ford	Aerostar	1997-1986		K3500	1996	
	Bronco II	1990-1984		P3500	1999-1996	
	Contour	2000-1995		Savana 1500	1997-1996	
	Crown Victoria	2011-1992		Savana 2500	1997-1996	
	E-150	2014-2003		Savana 3500	1996	
	E-150 Club Wagon	2005-2003		Sonoma	1997-1996	
	E-150 Econoline	2002-1997		Yukon	1996	
	E-150 Econoline Club Wagon	2002-1997		Isuzu	Hombre	1999-1997
	E-250	2014-2003		Lincoln	Aviator	2005-2003
	E-250 Econoline	2002-1997			Blackwood	2002
	E-350 Club Wagon	2005-2003			Continental	2002-1995
	E-350 Econoline	1998-1997			LS	2005-2000
	E-350 Econoline Club Wagon	2002-1997			Mark VIII	1998-1993
	E-350 Super Duty	2017-1999			Navigator	2004-1998
	E-450 Econoline Super Duty	2002-1999			Town Car	2009-1991
	E-450 Super Duty	2017-2003			Town Car	2011
	E-550 Econoline Super Duty	2002			Zephyr	2006
	E-550 Super Duty	2003		Mercury	Capri	1979
	Econoline Super Duty	1999-1997			Capri	1984-1982
	Escape	2008-2001			Cougar	1986-1984
	Escort	1985-1982			Cougar	1997-1994
	Excursion	2005-2000			Cougar	2002-1999
	EXP	1985-1982			Grand Marquis	2011-1992
	Expedition	2004-1997			LN7	1983-1982
	Explorer	2005-1991			Lynx	1982
	Explorer Sport	2003-2001			Lynx	1985-1984
	Explorer Sport Trac	2005-2001			Marauder	2004-2003
	F53	2004-1999			Mariner	2008-2005
	F-100	1983			Marquis	1984-1983
	F-150	1995-1993			Milan	2009-2006
	F-150	2009-1997			Montego	2007-2005
	F-150 Heritage	2004			Mountaineer	2006-1997
	F-250	1999-1997			Mystique	2000-1995
	F-250 Super Duty	2004-1999			Sable	2005-1986
	F-350 Super Duty	2004-1999			Topaz	1994-1984
	F-450 Super Duty	2004-1999		Merkur	Scorpio	1989-1988
	F-550 Super Duty	2004-1999		Oldsmobile	98	1987-1986
	Fiesta	1979-1978			Achieva	1993-1992
	Five Hundred	2007-2005			Achieva	1998-1995
	Focus	2011			Alero	2001-1999
	Freestar	2005-2004			Aurora	1999-1995
	Freestyle	2007-2005			Aurora	2003-2001
	Fusion	2009-2006			Bravada	2001-1996
	LTD	1983			Calais	1987-1985
	Mustang	1983			Cutlass Calais	1991-1988
	Mustang	2004-1991			Cutlass Ciera	1993-1986
	Probe	1992-1990			Cutlass Cruiser	1990-1987
Ranger	2011-1983			Cutlass Supreme	1995-1991	
Taurus	2006-1986			Delta 88	1988-1986	
Tempo	1994-1984			Intrigue	2002-1999	
Thunderbird	1983			Toronado	1987-1986	
Thunderbird	1997-1994		Panoz	Esperante	2005-2003	
Transit Connect	2013-2010		Pontiac	Bonneville	1988-1987	
Windstar	2003-1995			Bonneville	2005-2004	
GMC	C1500	1997-1996		Firebird	1997-1993	
	C1500 Suburban	1996		Grand Am	1987-1985	
	C2500	1996		Grand Am	1993-1992	
	C2500 Suburban	1996		Grand Am	2001-1995	
	C3500	1996		Grand Prix	1995-1991	
	C3500HD	2002-2001		Sunfire	2002-1995	
	Jimmy	1997-1996				
	K1500	1997-1996				
	K1500 Suburban	1996				
	K2500	1996				
			<b>97292</b>	<b>LKAR6AHX</b>	<b>Ruthenium HX</b>	
Qty per Vehicle: 4		Box Qty: 4	Qty per Vehicle: 4		Box Qty: 4	
	Chevrolet	2017-2015		City Express	2017-2015	
	Nissan	2017-2007		Altima	2017-2007	



97292 (Cont'd)	LKAR6AHX	Ruthenium HX	97382 (Cont'd)	GR4IX	Iridium IX
Qty per Vehicle: 4		Box Qty: 4	Qty per Vehicle: 1-8		Box Qty: 4
Nissan	Cube	2014-2009	Chevrolet	Luv Pickup	1974-1972
	Frontier	2017-2005		Malibu	1967-1964
	Micra	2017-2015		Nova	1970
	NV200	2017-2013		P10 Series	1967-1963
	Rogue	2017-2008		P10 Van	1969-1968
	Rogue Select	2015-2014		P20 Series	1966-1963
	Sentra	2017-2007		P30 Series	1966-1963
	Versa	2017-2007		Suburban	1966-1963
Versa Note	2017-2014	Chrysler	300	1958-1955	
<b>97382</b>			<b>GR4IX</b>	<b>Iridium IX</b>	
Qty per Vehicle: 1-8			Box Qty: 4	Cordoba	1983-1975
American Motors	Ambassador		1974-1965	Daytona	1993-1984
	American		1968-1964	Dynasty	1993-1988
	AMX		1970-1968	E Class	1984-1983
	AMX		1979-1978	Fifth Avenue	1989-1983
	Classic		1966-1964	Imperial	1958-1957
	Concord		1979-1978	Imperial	1982-1981
	Gremlin		1977-1970	Laser	1986-1984
	Hornet		1977-1970	LeBaron	1994-1977
	Javelin		1974-1968	Nassau	1955
	Marlin		1967-1965	Newport	1958-1955
	Matador		1978-1971	Newport	1972-1971
	Pacer		1979-1975	Newport	1981-1974
	Rambler		1969	New Yorker	1958-1956
	Rebel		1970-1967	New Yorker	1988-1977
Spirit	1979		St Regis	1956	
Bentley	Corniche	1980-1971	TC Maserati	1989	
	Corniche	1983-1982	Town & Country	1958-1955	
	Mulsanne	1983-1981	Town & Country	1988-1978	
	T1 Series	1976-1968	Windsor	1956-1955	
Buick	T2 Series	1980-1977	Dodge	330	1964
	Skyllark	1969-1968		400	1983-1982
Special	1969-1968	600		1988-1983	
Cadillac	Calais	1974-1968		A100	1966-1964
	DeVille	1974-1968		A100	1970
	Eldorado	1974-1968		A100 Truck	1970-1964
Checker	Fleetwood	1974-1968		A108 Van	1970-1967
Chevrolet	Marathon	1969-1968		Aries	1989-1981
	Bel Air	1961-1958		Aspen	1980-1976
	Bel Air	1969-1963		B100	1980-1975
	Biscayne	1961-1958		B100 Van	1974-1971
	Biscayne	1969-1963		B150	1991-1981
	Blazer	1969		B200	1980-1975
	Brookwood	1969		B200 Van	1974-1971
	C10 Pickup	1969-1963		B250	1992-1981
	C10 Suburban	1969-1968		B300	1980-1975
	C20 Pickup	1969-1963		B300 Van	1974-1971
	C20 Suburban	1969-1968		B350	1992-1981
	C30 Pickup	1969-1964		Caravan	1995-1984
	Camaro	1969-1967		CB300	1980-1974
	Caprice	1969-1967		Challenger	1974-1970
	Chevelle	1969-1964		Charger	1978-1967
	Chevy II	1968-1962		Charger	1987-1983
	El Camino	1960-1959		Coronet	1958-1957
	El Camino	1969-1964	Coronet	1976-1965	
	G10 Van	1969-1964	Custom	1958-1957	
	G20 Van	1969-1967	D100	1979-1975	
	Impala	1961-1959	D100	1989-1984	
	Impala	1969-1963	D100 Pickup	1974-1968	
	K10 Pickup	1969-1964	D100 Series	1967-1961	
	K10 Suburban	1969-1967	D150	1991-1977	
	K20 Pickup	1969-1964	D200	1980-1975	
	K20 Suburban	1969-1968	D200 Pickup	1974-1968	
	K30 Pickup	1969-1968	D200 Series	1967-1961	
	LUV	1982-1975	D250	1992-1981	
				D300	1980-1975



97382 (Cont'd)	GR4IX	Iridium IX	97382 (Cont'd)	GR4IX	Iridium IX	
Qty per Vehicle: 1-8		Box Qty: 4	Qty per Vehicle: 1-8		Box Qty: 4	
Dodge	D300 Pickup	1974-1968	GMC	PB1000 Series	1965-1963	
	D300 Series	1967-1961		PB2500 Series	1963	
	D350	1992-1981		Suburban	1966-1963	
	D400	1981-1978		International	1000D	1970-1969
	D450	1981-1978			1010	1971
	Dakota	1995-1987			1100D	1970-1969
	Dart	1976-1960			1110	1971
	Daytona	1993-1984			1200D	1970-1969
	Diplomat	1989-1977			1210	1971
	Dynasty	1993-1988			1300D	1970-1969
	Grand Caravan	1989-1987			1310	1971
	Lancer	1962-1961			M800	1971-1969
	Lancer	1989-1985			M800 Navy	1969
	Magnum	1979-1978			M800 Post Office	1971-1969
	Mini Ram	1988-1984			M1100	1971-1969
	Mirada	1983-1980			M1200	1971-1969
	Monaco	1978-1968			M1400	1969
	Omni	1990-1978	MA1200		1971-1969	
	P100	1966-1965	Scout		1970-1969	
	P100	1968	Scout II	1971		
	P200	1966-1965	Jeep	Cherokee	1983-1974	
	P200	1972-1968		CJ5	1981-1972	
	P300	1972-1968		CJ6	1975-1972	
	Polara	1964-1963		CJ7	1981-1976	
	Polara	1973-1966		Commando	1973-1972	
	Ramcharger	1992-1974		DJ5	1974-1972	
	Rampage	1984-1982		Gladiator	1967-1965	
	RD200	1980-1978		Grand Wagoneer	1991-1984	
	Royal Monaco	1977-1975		J10	1988-1974	
	Shadow	1994-1987		J20	1988-1974	
	Spirit	1995-1989		J-100	1971-1965	
	St. Regis	1981-1979		J-2500	1973-1968	
	W100	1977-1975		J-2600	1970-1968	
	W100	1989-1984		J-2600	1973-1972	
	W100 Pickup	1974-1968		J-2700	1969-1968	
	W100 Series	1967-1961		J-3500	1970-1968	
	W150	1991-1977		J-3600	1970-1968	
	W200	1980-1975	J-3700	1970-1968		
	W200 Pickup	1974-1969	J-3800	1968		
	W200 Series	1967-1961	Wagoneer	1983-1971		
W250	1992-1981	Mercury	Bobcat	1976-1975		
W300	1980-1975		Capri	1974-1971		
W300 Pickup	1974-1968		Capri	1976		
W300 Series	1967-1963		Tracer	1990-1987		
W350	1992-1981	Oldsmobile	Cutlass	1969-1968		
GMC	1000 Series		1965-1964	F85	1969-1966	
	1500 Series		1965-1964	Firenza	1986-1982	
	C15/C1500 Pickup	1969-1967	Plymouth	Acclaim	1995-1989	
	C15/C1500 Suburban	1969-1968		Barracuda	1974-1964	
	C25/C2500 Pickup	1969-1967		Belvedere	1970-1963	
	C25/C2500 Suburban	1969-1968		Caravelle	1989-1978	
	C35/C3500 Pickup	1969-1967		Cuda	1974-1971	
	G15/G1500 Van	1969-1967		Custom	1958	
	G25/G2500 Van	1969-1967		Duster	1976-1970	
	G1000 Series	1966-1964		Expo	1989-1987	
	K15/K1500 Pickup	1969-1967		Fleet Special	1963-1960	
	K15/K1500 Suburban	1969-1968		Fury	1965	
	K25/K2500 Pickup	1969-1967		Fury	1978-1968	
	K25/K2500 Suburban	1969-1968		Fury I	1974-1968	
	K35/K3500 Pickup	1969-1968		Fury II	1974-1968	
	P15/P1500 Van	1969-1967		Fury III	1974-1968	
	P25/P2500 Van	1967		Grand Voyager	1988-1987	
	P35/P3500 Van	1967		Gran Fury	1977-1972	
	PB15 Series	1966	Gran Fury	1989-1980		
	PB25 Series	1966	GTX	1971-1967		



97382 (Cont'd)		GR4IX	Iridium IX	97390 (Cont'd)		LKR7BGP-S	G-Power	
Qty per Vehicle: 1-8			Box Qty: 4	Qty per Vehicle: 4-8			Box Qty: 4	
Plymouth	Horizon		1990-1978	Honda	Civic		2015-2012	
	PB100		1980-1975		Crosstour		2015-2012	
	PB100 Van		1974		CR-V		2014-2010	
	PB150		1981		HR-V		2018-2016	
	PB150		1983		Odyssey		2018-2008	
	PB200		1980-1975		Pilot		2017-2009	
	PB200 Van		1974		Ridgeline		2014-2009	
	PB250		1983-1981		Ridgeline		2018-2017	
	PB300		1980-1975		Hyundai	Azera		2017-2012
	PB300 Van		1974			Elantra		2016-2012
	PB350		1983-1981			Elantra Coupe		2014-2013
	Reliant		1989-1981			Elantra GT		2015-2013
	Road Runner		1975-1968	Equus			2016-2012	
	Satellite		1969-1965	Genesis			2016-2012	
	Satellite		1974-1971	Genesis Coupe			2016-2010	
	Savoy		1964	Santa Fe			2018-2010	
	Scamp		1976-1971	Santa Fe XL		2018-2013		
	Scamp		1983	Tucson		2017-2014		
	Sundance		1994-1987	Jeep	Cherokee		2017-2014	
	Trailduster		1981-1974		Grand Cherokee		2015-2011	
Turismo		1985	Wrangler			2017-2012		
Valiant		1976-1964	Kia	Cadenza		2017-2014		
Volare		1980-1976		Forte		2017-2014		
Voyager		1995-1984		Forte5		2017-2014		
Pontiac	Firebird			1969-1967	Forte Koup		2016-2014	
	LeMans			1965-1964	K900		2017-2015	
	LeMans			1969-1967	Rondo		2017-2014	
	LeMans			1990-1989	Sedona		2012-2011	
	Optima			1990-1988	Sedona		2017-2014	
	Sunbird		1991-1989	Sorento		2017-2011		
	Tempest		1965-1964	Soul		2017-2012		
	Tempest		1969-1967	Mitsubishi	Outlander		2017-2014	
Rolls-Royce	Camargue		1987-1975	Ram	1500		2017-2013	
	Corniche		1983-1971	C/V			2015-2012	
	Phantom		1967-1960	ProMaster 1500			2017-2014	
	Silver Cloud		1965-1955	ProMaster 2500			2017-2014	
	Silver Shadow		1976-1966	ProMaster 3500			2017-2014	
	Silver Shadow II		1980-1977	Volkswagen	Routan		2014-2011	
	Silver Spirit		1986-1981	<b>97408 LZTR6AP11EG Laser Platinum</b>				
	Silver Spur		1986-1981	Qty per Vehicle: 16			Box Qty: 4	
	Silver Wraith		1958-1955	Chrysler	300		2014-2012	
	Silver Wraith II		1980-1977	Dodge	Challenger		2017-2011	
					Charger		2017-2012	
				Jeep	Grand Cherokee		2017-2012	
<b>97390</b>		<b>LKR7BGP-S</b>	<b>G-Power</b>	<b>97506</b>		<b>SILZKBR8D8S</b>	<b>Laser Iridium</b>	
Qty per Vehicle: 4-8			Box Qty: 4	Qty per Vehicle: 4-8			Box Qty: 4	
Acura	ILX		2015-2013	BMW	135i		2013-2011	
	MDX		2017-2010		135is		2013	
	RDX		2018-2013		228i		2016-2014	
	RL		2012-2009		228i xDrive		2016-2015	
	RLX		2017-2014		320i		2017-2012	
	TL		2014-2009		320i xDrive		2017-2013	
	TLX		2018-2015		328i		2016-2012	
	TSX		2014-2009		328i GT xDrive		2016-2014	
	ZDX		2013-2010		328i xDrive		2016-2013	
Chrysler	200		2017-2011		335i		2015-2011	
	300		2017-2011		335i GT xDrive		2016-2014	
	Town & Country		2016-2011		335i xDrive		2015-2011	
Dodge	Avenger		2014-2011		428i		2016-2014	
	Challenger		2017-2011		428i Gran Coupe		2016-2015	
	Charger		2017-2011	428i xDrive		2016-2014		
	Durango		2015-2011	428i xDrive Gran Coupe		2016-2015		
	Grand Caravan		2017-2011	435i		2016-2014		
	Journey		2017-2011	435i Gran Coupe		2016-2015		
Genesis	G80		2017					
Honda	Accord		2017-2008					
	Accord Crosstour		2011-2010					



97506 (Cont'd)		SILZKBR8D8S	Laser Iridium	97932 (Cont'd)		IZFR5L11	Laser Iridium	
Qty per Vehicle: 4-8			Box Qty: 4	Qty per Vehicle: 4-8			Box Qty: 4	
BMW	435i xDrive		2016-2014	Chrysler	Sebring		2010-2009	
	435i xDrive Gran Coupe		2016-2015	Dodge	Avenger		2014-2008	
	528i		2016-2012		Caliber		2010-2008	
	528i xDrive		2016-2012		Dakota		2007-2005	
	535i		2016-2011		Journey		2010-2009	
	535i GT		2017-2010		Journey		2017-2016	
	535i GT xDrive		2017-2011	Hyundai	Elantra		2012-2007	
	535i xDrive		2016-2011	Jeep	Compass		2009	
	550i		2016-2014		Compass		2017-2016	
	550i GT		2015-2013		Patriot		2009	
	550i GT xDrive		2017-2013		Patriot		2017-2015	
	550i xDrive		2016-2013	Kia	Soul		2011-2010	
	640i		2017-2012		Spectra		2009-2008	
	640i Gran Coupe		2017-2013		Spectra5		2009-2008	
	640i xDrive		2017-2014	<b>98376</b>		<b>DILFR5A-11D</b>	<b>Laser Iridium</b>	
	640i xDrive Gran Coupe		2017-2014	Qty per Vehicle: 4-8			Box Qty: 4	
	650i		2017-2013	Hyundai	Santa Fe		2012-2010	
	650i Gran Coupe		2017-2013		Sonata		2010-2009	
	650i xDrive		2017-2013		Tucson		2013-2010	
	650i xDrive Gran Coupe		2017-2013	Kia	Forte		2013-2010	
	740i		2015-2013		Forte5		2013-2012	
	740Li		2015-2013		Forte Koup		2013-2010	
	740Li xDrive		2015-2013		Magentis		2010-2009	
	750i		2015-2013		Optima		2010-2009	
	750i xDrive		2015-2013		Rondo		2012-2009	
	750Li		2015-2013		Sorento		2013-2011	
	750Li xDrive		2015-2013		Sportage		2013-2011	
	ActiveHybrid 3		2015-2013		Nissan	Armada		2015-2007
	ActiveHybrid 5		2016-2012			Frontier		2017
	ActiveHybrid 7		2015-2013	Titan			2015-2007	
	Alpina B6 Gran Coupe		2016					
	Alpina B6 xDrive Gran Coupe		2017-2015					
	Alpina B7		2015-2013					
	Alpina B7L		2015-2013					
	Alpina B7L xDrive		2015-2013					
	Alpina B7 xDrive		2015-2013					
	M235i		2016-2014					
	M235i xDrive		2016-2015					
	X1		2015-2012					
	X3		2017-2011					
X4		2017-2015						
X5		2017-2011						
X6		2017-2011						
Z4		2016-2012						
<b>97537</b>		<b>R2558E-9</b>	<b>Racing</b>					
Qty per Vehicle: 4			Box Qty: 4					
Scion	FR-S		2016-2013					
Subaru	BRZ		2017-2013					
Toyota	86		2017					
<b>97606</b>		<b>PLZFR5B13EG</b>	<b>Laser Platinum</b>					
Qty per Vehicle: 8-16			Box Qty: 4					
Chrysler	Aspen		2009-2008					
Dodge	Dakota		2010-2008					
	Durango		2009-2008					
	Ram 1500		2010-2008					
Jeep	Commander		2009-2008					
	Grand Cherokee		2009-2008					
Ram	1500		2013-2011					
	Dakota		2011					
<b>97932</b>		<b>IZFR5L11</b>	<b>Laser Iridium</b>					
Qty per Vehicle: 4-8			Box Qty: 4					
Acura	CL		2003					
	TL		2003					
Chrysler	200		2014-2011					



Competitor #	NGK Stock #	NGK Part #	Competitor #	NGK Stock #	NGK Part #	Competitor #	NGK Stock #	NGK Part #
<b>Accel</b>			<b>ACDelco</b>			<b>ACDelco</b>		
112	2912	BP8ES	6	7300	TR4IX	41-801	3248	FR5GP
113	1034	BP7ES	7	7293	XR45IX	41-802	5760	PGR5C-11
114	7333	BP6ES	8	3186	TR5GP	41-803	3547	UR5GP
115	7432	B6ES	8	7397	TR5IX	41-804	5555	PFR6G-11
116	7832	BP5ES	9	6418	BKR6EIX	41-805	3784	PTR5D-10
137	2298	R5670-5	9G	90046	Y1033AS	41-806	1041	ZFR6A-11
138	5858	XR4	10	3547	UR5GP	41-806	3271	PZFR6F-11
141	2611	B9ES	10	7177	UR5IX	41-807	7781	ZFR5LP-13G
142	2411	B8ES	11	7243	TR5-11X	41-808	2685	FR4GP
143	1111	B7ES	12	3403	TR55GP	41-809	3547	UR5GP
146	6410	B5ES	12	7164	TR55IX	41-810	7740	PTR5C-13
166	3212	B-6L	14	3403	TR55GP	41-810	97287	ITR5H13
168	3112	B-4L	14	7164	TR55IX	41-811	7159	TR55-1GP
276	2771	UR5	15	7164	TR55IX	41-812	3689	TR6IX
378	2438	WR5	16	7164	TR55IX	41-812	7740	PTR5C-13
416	1266	BCPR5EY	17	4344	LTR5IX-11	41-813	2635	GR4
437	5858	XR4	18	7100	ZFR6FGP	41-814	2467	PTR5A-13
494	5534	BPR7ES	19	7092	BKR6EGP	41-814	90083	LTR5BI-13
496	7734	BPR5ES	20	5018	LF5AGP	41-814	90607	ILTR5K13
514	3690	TR7IX	21	2438	WR5	41-815	3072	FR45GP
516	2238	TR5	30G	3473	Y-924J	41-816	7272	UR55IX
524	3690	TR7IX	32G	97928	Y1037J	41-817	3547	UR5GP
526	3951	TR55	37G	97928	Y1037J	41-818	7293	XR45IX
566	7052	YR5	41-2XLS	1034	BP7ES	41-819	3142	GR45GP
576	2771	UR5	41-4XLS	7333	BP6ES	41-821	3547	UR5GP
577	6630	UR4	41-100	4213	IZTR4A11	41-822	3716	TR5-1GP
586	2248	UR55	41-101	5599	ITR4A15	41-823	4652	WR4-1
736	7558	ZFR5F	41-103	3474	ILTR5B11	41-824	7159	TR55-1GP
784	4644	BKR7E	41-104	3689	TR6IX	41-825	4793	PFR6G
786	7938	BKR5E	41-105	5581	ILTR5C11	41-826	7272	UR55IX
997	5077	ZGR5A	41-106	92085	IFR6V-10G	41-827	7082	BPR5EGP
2410A	7634	BPR5ES-11	41-107	90117	ILTR6E11	41-828	4055	BPR7EIX
Y2418P	6046	DCPR7EIX	41-108	5581	ILTR5C11	41-829	7746	IFR7G-11KS
<b>ACDelco</b>			41-109	90117	ILTR6E11	41-830	2953	YR5GP
1	3547	UR5GP	41-110	1465	IZTR5B11	41-831	5693	BKR4EIX
1	7177	UR5IX	41-111	4589	IFR6T11	41-833	7355	XR5IX
2	3207	UR45GP	41-112	4912	ILKAR7B11	41-834	4997	PLZTR4A-13
2	7177	UR5IX	41-115	96329	ILTR5L11	41-834	5017	LZTR4AGP
2CR43TS	2771	UR5	41-119	95609	IFR6Z7G	41-835	95712	LZFR6AP11GS
2FR3LS6	6953	BKR5E-11	41-120	95609	IFR6Z7G	41-837	3381	LZTR5AGP
2FR4LSJ	5424	BKR4E-11	41-121	91039	IFR7X7G	41-900	7397	TR5IX
2R42XLS	7131	BPR6ES	41-122	95609	IFR6Z7G	41-902	7164	TR55IX
2R43TS6	2248	UR55	41-125	94489	ILTR6M9G	41-904	7397	TR5IX
2R43XLS	7131	BPR6ES	41-127	91715	IKR7H8	41-905	7401	UR4IX
2R44LTS	2238	TR5	41-147	90543	ILTR7E9	41-906	7397	TR5IX
2R44LTS6	3951	TR55	41-600	3951	TR55	41-907	7397	TR5IX
2R44LTSM	3754	TR4	41-601	3951	TR55	41-910	7397	TR5IX
2R44TS	2771	UR5	41-602	7373	FR5	41-913	7164	TR55IX
2R44XLS	7734	BPR5ES	41-603	5155	FR4	41-919	7164	TR55IX
2R45LTS6	3951	TR55	41-604	4652	WR4-1	41-919	7740	PTR5C-13
2R45TS	6630	UR4	41-606	3951	TR5	41-928	7316	TR55-1IX
2R45TS8	6945	UR45	41-608	3686	FR45	41-929	7164	TR55IX
2R45TSX	6945	UR45	41-610	5155	FR4	41-931	7164	TR55IX
2R45XLS	7734	BPR5ES	41-611	3686	FR45	41-931	7740	PTR5C-13
2R46SX	4536	XR45	41-618	4268	GR45	41-932	7164	TR55IX
2R46SZ	4536	XR45	41-627	5643	BKR5ESA-11	41-932	7862	PZTR5A-15
2R46TS	6630	UR4	41-627	6953	BKR5E-11	41-936	7164	TR55IX
3	3186	TR5GP	41-628	5424	BKR4E-11	41-936	7740	PTR5C-13
3	7397	TR5IX	41-628	7755	BKR4ESA-11	41-937	7740	PTR5C-13
4	6597	BPR5EIX	41-629	7938	BKR5E	41-942	7164	TR55IX
4	7082	BPR5EGP	41-630	3686	FR45	41-942	7740	PTR5C-13
5	5155	FR4	41-631	3459	ZFR5N	41-943	7164	TR55IX
5	7092	BKR6EGP	41-800	7090	BKR5EGP	41-943	7740	PTR5C-13
6	3186	TR5GP	41-801	2978	BKR6EP-11	41-947	7164	TR55IX

NOTE: Cross references are provided as a GUIDE ONLY. Due to differences in design / materials, products produced by various mfrs may have different specifications. Please refer to specific application guide for proper usage.

408 NOTA: El cruce de referencias servirá únicamente como guía. Las diferencias en diseño, materiales y los productos utilizados para su elaboración pueden variar dependiendo del fabricante. Para obtener la aplicación correcta de su vehículo, por favor referirse a la sección correspondiente dentro de esta guía.





Competitor #	NGK Stock #	NGK Part #	Competitor #	NGK Stock #	NGK Part #	Competitor #	NGK Stock #	NGK Part #
ACDelco			ACDelco			ACDelco		
41-948	7300	TR4IX	46TS	6630	UR4	1835430T	7164	TR55IX
41-948	7740	PTR5C-13	46XL	6410	B5ES	1835448T	7243	TR5-1IX
41-950	7740	PTR5C-13	48	3210	B-4	1835464T	7164	TR55IX
41-952	7164	TR55IX	61G	90046	Y1033AS	1835594T	2248	UR55
41-952	7862	PZTR5A-15	63G	97788	Y1032AS	1835616T	5599	ITR4A15
41-955	2467	PTR5A-13	83CTS	2438	WR5	1835704T	7300	TR4IX
41-962	3784	PTR5D-10	83TS	2438	WR5	1835712T	7052	YR5
41-963	7740	PTR5C-13	84TS	2438	WR5	1835720T	2771	UR5
41-965	2467	PTR5A-13	85T	2438	WR5	1835738T	7240	YR55
41-974	7164	TR55IX	85TS	2438	WR5	1835746T	2248	UR55
41-974	7862	PZTR5A-15	86TS	2438	WR5	1835754T	7734	BPR5ES
41-980	7740	PTR5C-13	101G	4705	Y-745U	1835762T	5599	ITR4A15
41-981	2467	PTR5A-13	241-602	7938	BKR5E	1835770T	7300	TR4IX
41-985	1465	IZTR5B11	241-603	5155	FR4	1835788T	7164	TR55IX
41-986	7397	TR5IX	241-606	3951	TR55	1835796T	6945	UR45
41-987	7740	PTR5C-13	241-902	7164	TR55IX	1835800T	6630	UR4
41-988	3587	PLTR6A-10G	241-904	7397	TR5IX	1835818T	6945	UR45
41-990	2467	PTR5A-13	241-905	7401	UR4IX	1835826T	7164	TR55IX
41-991	3690	TR7IX	241-906	7397	TR5IX	1835834T	5424	BKR4E-11
41-993	1209	PTR4G-15	241-908	7164	TR55IX	1835842T	5424	BKR4E-11
41-993	5599	ITR4A15	241-910	7397	TR5IX	1835876T	4536	XR45
41F	5510	B8HS	241-913	7164	TR55IX	1835906T	6630	UR4
41TS	7348	UR6IX	241-919	7164	TR55IX	1835914T	6945	UR45
41XL	2411	B8ES	241-921	5599	ITR4A15	1835922T	4536	XR45
41XLS	1034	BP7ES	241-928	7243	TR5-1IX	1835930T	2771	UR5
42F	7534	B6HS	241-932	7164	TR55IX	1835948T	3951	TR55
42FF	7534	B6HS	241-936	7164	TR55IX	1835956T	7734	BPR5ES
42FS	7331	BP6HS	241-940	7300	TR4IX	1835974T	3951	TR55
42LTS	3623	BPR6EFS	241-943	7300	TR4IX	1844012T	3722	BR5HS
42XL	2411	B8ES	241-947	7164	TR55IX	1844038T	7740	PTR5C-13
42XLS	7333	BP6ES	422Z	4210	B5HS	1844046T	7300	TR4IX
43F	7534	B6HS	425F	7534	B6HS	1844054T	7060	TR5-1
43FFS	7331	BP6HS	425Z	7534	B6HS	1844168T	6953	BKR5E-11
43FS	7331	BP6HS	426FS	7331	BP6HS	5613611	3754	TR4
43N	1111	B7ES	430Z	5110	B7HS	5613869	3951	TR55
43XL	1111	B7ES	438XLS	2912	BP8ES	5613877	6945	UR45
43XLS	7333	BP6ES	440XLS	2912	BP8ES	5614283	3951	TR55
44F	4210	B5HS	445Z	5510	B8HS	5614284	3951	TR55
44FF	4210	B5HS	1052895W	6630	UR4	09146367(FLR8L DCU)	2288	BKR6EK
44FFS	4111	BP5HS	1835028T	7131	BPR6ES	09195109(FLR8L DCU)	2288	BKR6EK
44N	7432	B6ES	1835036T	7131	BPR6ES	9195166	7797	BKR5EK
44NS	7832	BP5ES	1835044T	3754	TR4	12556183	7740	PTR5C-13
44S	2298	R5670-5	1835078T	2238	TR5	12561466	7164	TR55IX
44T	7052	YR5	1835108T	3951	TR55	12561466	7740	PTR5C-13
44TS	6630	UR4	1835124T	2771	UR5	12563707	7164	TR55IX
44XL	7432	B6ES	1835132T	3332	XR5	12563707	7862	PZTR5A-15
44XLO	7832	BP5ES	1835174T	4268	GR45	12565753	7164	TR55IX
44XLS	7832	BP5ES	1835182T	3754	TR4	12565753	7862	PZTR5A-15
45	3210	B-4	1835212T	7060	TR5-1	12565996	6619	LFTR6AIX-11
45F	4210	B5HS	1835238T	7938	BKR5E	12568387	5599	ITR4A15
45FF	4210	B5HS	1835246T	7938	BKR5E	12571164	1465	IZTR5B11
45FFS	4111	BP5HS	1835262T	5155	FR4	12571165	3689	TR6IX
45L	3112	B-4L	1835270T	6953	BKR5E-11	12571533	7397	TR5IX
45NS	7832	BP5ES	1835288T	5858	XR4	12571535	7740	PTR5C-13
45S	2298	R5670-5	1835300T	3951	TR55	12582002	3657	IZFR5K11
45TS	6630	UR4	1835318T	3951	TR55	12592619	3690	TR7IX
45XL	7432	B6ES	1835342T	7164	TR55IX	12597464	2467	PTR5A-13
45XLS	7832	BP5ES	1835350T	7397	TR5IX	12598004	3474	ILTR5B11
46	3210	B-4	1835368T	2815	TR4GP	12607234	1209	PTR4G-15
46F	4210	B5HS	1835376T	7401	UR4IX	12620540	5581	ILTR5C11
46FF	4210	B5HS	1835384T	7397	TR5IX	12621258	1465	IZTR5B11
46FFS	4111	BP5HS	1835406T	7164	TR55IX	12622561	90117	ILTR6E11
46N	6410	B5ES	1835414T	7164	TR55IX	19145283	3547	UR5GP
46S	2298	R5670-5	1835422T	7397	TR5IX			

NOTE: Cross references are provided as a GUIDE ONLY. Due to differences in design / materials, products produced by various mfrs may have different specifications. Please refer to specific application guide for proper usage.

REMARQUE: Les références sont fournies en GUIDE UNIQUEMENT. En raison des différences de conception et de matériaux, des produits fabriqués par différents fabricants peuvent avoir des spécifications différentes. Veuillez vous référer au guide d'application spécifique pour l'utilisation correcte.



# Interchanges / Références

THE IGNITION SPECIALIST™

Competitor #	NGK Stock #	NGK Part #	Competitor #	NGK Stock #	NGK Part #	Competitor #	NGK Stock #	NGK Part #
ACDelco			ACDelco			ACDelco		
19145290	3186	TR5GP	C85	2910	AB-6	MC122F	7112	D8HA
19145292	3547	UR5GP	C85TS	2438	WR5	MC124FS	6512	D6HA
19158038	6579	PTR5F-11	C86	2910	AB-6	MR42K	3522	BR6S
19238478	2763	GR4GP	C87	2910	AB-6	MR42LTS	3623	BPR6EFS
19250960	3547	UR5GP	CF44TS	6630	UR4	MR43LTS	2238	TR5
19250961	3207	UR45GP	CFR1CLS	4644	BKR7E	MR44C	3522	BR6S
19250962	3186	TR5GP	CFR2CLS	6962	BKR6E	MR44T	7052	YR5
19250963	3186	TR5GP	CR5CXLS	3351	GR5GP	MR45	3210	B-4
19250967	3186	TR5GP	CR42CFS	2771	UR5	R41-5TS	2771	UR5
19300383	7052	YR5	CR42CXLS	2851	GR5	R41CF	4122	BR7HS
19300872	90117	ILTR6E11	CR42CXLS	7131	BPR6ES	R41CSL	5422	BR8ES
21025102	5424	BKR4E-11	CR42N	5122	BR7ES	R41CXL	5722	BR9ES
21025102	7755	BKR4ESA-11	CR42TS	2771	UR5	R41CXLS	3923	BPR8ES
21025103	5643	BKR5ESA-11	CR43	3522	BR6S	R41CXLS	5534	BPR7ES
21025103	6953	BKR5E-11	CR43CXLS	7131	BPR6ES	R41F	4522	BR9HS
24425327	3199	BKR6EQUP	CR43K	3522	BR6S	R41TS	7773	UR6
25164048	7740	PTR5C-13	CR43N	4922	BR6ES	R41XL	5722	BR9ES
25164639	3547	UR5GP	CR43S	3332	XR5	R41XLS	7788	BPR9ES
25164640	7397	TR5IX	CR43TS	2771	UR5	R42-5LTS	2238	TR5
25164641	3186	TR5GP	CR43TSM	2771	UR5	R42-5LTS	3623	BPR6EFS
25164642	7082	BPR5EGP	CR44N	4922	BR6ES	R42-5TS	2771	UR5
25164644	3186	TR5GP	CR44NS	2635	GR4	R42-6FS	7022	BPR6HS
25165715	7740	PTR5C-13	CR44NS	7734	BPR5ES	R42CF	3922	BR6HS
25186682	90318	ZFR6U-9	CR44TS	6630	UR4	R42CFS	7022	BPR6HS
25332827	7164	TR55IX	CR44TSM	2771	UR5	R42CLTS	2238	TR5
25332828	7164	TR55IX	CR45TS	6630	UR4	R42CLTS	3623	BPR6EFS
55564748	97218	DILFR7B10G	CR83T	3323	AR6FS	R42CTS	2771	UR5
92067204	4344	LTR5IX-11	FR1LS	6962	BKR6E	R42CXL	5422	BR8ES
92108895	7164	TR55IX	FR2LS	6962	BKR6E	R42CXLS	2851	GR5
92141875	3951	TR55	FR2LS	7373	FR5	R42CXLS	7131	BPR6ES
92143446	3689	TR6IX	FR2LSK	6962	BKR6E	R42F	3922	BR6HS
93175880	4563	BCP6ET	FR2LSK	7373	FR5	R42FS	7022	BPR6HS
93176801	7558	ZFR5F	FR3CLS	5155	FR4	R42LTS	2238	TR5
93180485	2262	ZFR5F-11	FR3CLS	7938	BKR5E	R42LTS	3623	BPR6EFS
93742296	7734	BPR5ES	FR3CLS6	3686	FR45	R42LTS6	3951	TR55
94859448	4996	IFR5T11	FR3CLS6	6953	BKR5E-11	R42LTS6	2238	TR5
95519058	7558	ZFR5F	FR3LM	5084	ZFR5A-11	R42LTS6	3623	BPR6EFS
96130723	2756	BKR6E-11	FR3LS	5155	FR4	R42LTS6	2238	TR5
B44FS	4111	BP5HS	FR3LS	7938	BKR5E	R42TS	2771	UR5
B44S	7355	XR5IX	FR3LS6	3686	FR45	R42TSM	2771	UR5
B45	3210	B-4	FR3LSJ	5155	FR4	R42TX	7240	YR55
B4031	3210	B-4	FR3LSK	4421	BKR4E	R42XL	5422	BR8ES
C42CFS	7331	BP6HS	FR3LSK	5155	FR4	R42XLS	2851	GR5
C42CLTS	2238	TR5	FR4LE	4043	ZFR4F-11	R42XLS	7131	BPR6ES
C42CXLS	7333	BP6ES	FR4LS	4421	BKR4E	R42XLS6	2851	GR5
C42LTS	2238	TR5	FR4LS	5155	FR4	R42XLSM	6334	ZGR5C
C42N	1111	B7ES	FR4LSJ	4421	BKR4E	R43	3522	BR6S
C42XLS	7832	BP5ES	FR4LSJ	5155	FR4	R43C	3522	BR6S
C43CLTS	2238	TR5	FR5LM	5084	ZFR5A-11	R43CFS	7022	BPR6HS
C43CXLS	7333	BP6ES	FR5LS	4421	BKR4E	R43CNTSE	7060	TR5-1
C43L	3212	B-6L	FR5LS	5155	FR4	R43CS	3332	XR5
C43N	7432	B6ES	IC83	3010	AB-7	R43CTS	2771	UR5
C44N	7432	B6ES	M40FF	5810	B9HS	R43CTS6	2248	UR55
C44NS	7832	BP5ES	M41FF	5510	B8HS	R43CXL	5122	BR7ES
C44S	2298	R5670-5	M42FF	5110	B7HS	R43CXLS	7131	BPR6ES
C44XL	7432	B6ES	M43FF	7534	B6HS	R43FS	7022	BPR6HS
C45	3210	B-4	M44L	3212	B-6L	R43LTS	2238	TR5
C45L	3112	B-4L	M45	3210	B-4	R43LTS	3623	BPR6EFS
C46	3210	B-4	M45FF	4210	B5HS	R43LTS6	3951	TR55
C47	3210	B-4	M47	3210	B-4	R43LTSE	3754	TR4
C47W	3210	B-4	M86	2910	AB-6	R43LTS6	2238	TR5
C81	7909	AB-8	MC41F	5510	B8HS	R43LTSX	3951	TR55
C82	3010	AB-7	MC42F	5110	B7HS	R43N	5122	BR7ES
C83	3010	AB-7	MC104F	3228	C6HSA	R43NTSE	7060	TR5-1

NOTE: Cross references are provided as a GUIDE ONLY. Due to differences in design / materials, products produced by various mfrs may have different specifications. Please refer to specific application guide for proper usage.

410 NOTA: El cruce de referencias servirá únicamente como guía. Las diferencias en diseño, materiales y los productos utilizados para su elaboración pueden variar dependiendo del fabricante. Para obtener la aplicación correcta de su vehículo, por favor referirse a la sección correspondiente dentro de esta guía.



Competitor #	NGK Stock #	NGK Part #	Competitor #	NGK Stock #	NGK Part #	Competitor #	NGK Stock #	NGK Part #
<b>ACDelco</b>			<b>ACDelco</b>			<b>Autolite</b>		
R43T6	7240	YR55	R46T	7052	YR5	14	7773	UR6
R43TS	2771	UR5	R46TS	6630	UR4	15	6630	UR4
R43TS6	2248	UR55	R46TSX	6945	UR45	16	6630	UR4
R43TSK	2771	UR5	R46TX	7240	YR55	23	2771	UR5
R43TSX	2248	UR55	R46XL	5866	BR5ES	23BP	2771	UR5
R43TX	7240	YR55	R47S	5858	XR4	24	2771	UR5
R43XL	5122	BR7ES	R83CT	3323	AR6FS	25	6630	UR4
R43XLS	2851	GR5	R83CTS	2438	WR5	25	6945	UR45
R43XLS	7131	BPR6ES	R83T	3323	AR6FS	25BP	6630	UR4
R44	3522	BR6S	R83TS	2438	WR5	25DP2	6630	UR4
R44CF	3722	BR5HS	R84TS	2438	WR5	26	6630	UR4
R44CNTSE	7060	TR5-1	R84TSX	2438	WR5	26	6945	UR45
R44CXL	4922	BR6ES	R85T	3323	AR6FS	26BP	6945	UR45
R44CXLS	7734	BPR5ES	R85TS	2438	WR5	26DP2	6945	UR45
R44F	3722	BR5HS	R86T	3323	AR6FS	27	6945	UR45
R44LT	3177	BR6EF	R86TS5	2438	WR5	34	2438	WR5
R44LTS	3754	TR4	R121XLS	7162	DR8EA	35	2438	WR5
R44LTS6	3951	TR55	R425LTS	3623	BPR6EFS	36	2438	WR5
R44LTS6K	7164	TR55IX	R426FS	7022	BPR6HS	37	2438	WR5
R44LTSK6	3951	TR55	S40F	5810	B9HS	44	2438	WR5
R44LTSM	2238	TR5	S40FR	4522	BR9HS	45	2438	WR5
R44LTSM	3754	TR4	S40XL	7928	B10ES	45BP	2438	WR5
R44LTSM6	3951	TR55	S40XLG	4677	BR9ECS	45DP2	2438	WR5
R44LTSMA	3754	TR4	S40XLR	5422	BR8ES	46	2438	WR5
R44N	4922	BR6ES	S40XLR	5722	BR9ES	46BP	2438	WR5
R44NS	7734	BPR5ES	S41F	5510	B8HS	46DP2	2438	WR5
R44NTSE	7060	TR5-1	S41FR	4322	BR8HS	51	2912	BP8ES
R44S	5858	XR4	S41XL	2611	B9ES	52	1034	BP7ES
R44SX	4536	XR45	S41XLG	3035	BR8ECM	53	7333	BP6ES
R44T	7052	YR5	S41XLR	5722	BR9ES	54	7333	BP6ES
R44TS	6630	UR4	S42F	5110	B7HS	55	7832	BP5ES
R44TS8	6945	UR45	S42FR	4122	BR7HS	56	7832	BP5ES
R44TSX	6945	UR45	S42XL	2411	B8ES	62	5534	BPR7ES
R44TX	7240	YR55	S42XLR	5422	BR8ES	63	7131	BPR6ES
R44XL	4922	BR6ES	S43XL	1111	B7ES	63BP	7131	BPR6ES
R44XLS	2635	GR4	S43XLR	5122	BR7ES	63DP2	7131	BPR6ES
R44XLS	7734	BPR5ES	S44F	3722	BR5HS	64	2851	GR5
R44XLS6	4268	GR45	S44F	4210	B5HS	64	7131	BPR6ES
R44XLS6K	7164	TR55IX	S44XL	7432	B6ES	64	7634	BPR5ES-11
R44XLS6	4268	GR45	S45F	4210	B5HS	64BP	2851	GR5
R44XLS6	4268	GR45	S46	3210	B-4	64DP	2851	GR5
R44XLS6	4268	GR45	S81F	7909	AB-8	64DP2	2851	GR5
R44XLS6	4268	GR45	S82F	7909	AB-8	65	2635	GR4
R44XLS6	4268	GR45	S83F	3010	AB-7	65	7734	BPR5ES
R44XLS6	4268	GR45	S85F	2910	AB-6	65BP	2635	GR4
R44XLS6	4268	GR45	S102F	4629	C7HSA	65DP2	2635	GR4
R44XLS6	4268	GR45	S104F	3228	C6HSA	66	2264	BPR2ES
R44XLS6	4268	GR45	S121F	7112	D8HA	66BP	2264	BPR2ES
R44XLS6	4268	GR45	S121XL	2120	D8EA	66DP2	2264	BPR2ES
R44XLS6	4268	GR45	S122F	7112	D8HA	75	7355	XR5IX
R44XLS6	4268	GR45	S123XL	7912	D7EA	76	7355	XR5IX
R44XLS6	4268	GR45	S124FS	6512	D6HA	77	5858	XR4
R44XLS6	4268	GR45	S404XLG	3630	B10EG	84	3332	XR5
R44XLS6	4268	GR45	S408XLG	3530	B9EG	85	3332	XR5
R44XLS6	4268	GR45	S438XLG	3430	B8EG	85BP	3332	XR5
R44XLS6	4268	GR45	S438XLG	5044	BR8EIX	86	5858	XR4
R44XLS6	4268	GR45	SN46	3210	B-4	86BP	5858	XR4
R44XLS6	4268	GR45	TC81	7909	AB-8	87	5858	XR4
R44XLS6	4268	GR45	TC82	7909	AB-8	103	3623	BPR6EFS
R44XLS6	4268	GR45	TC83	3010	AB-7	103	3951	TR55
R44XLS6	4268	GR45	TC85	2910	AB-6	103	4177	TR6
R44XLS6	4268	GR45	TC86	2910	AB-6	103DP2	4177	TR6
R46S	5858	XR4	<b>Autolite</b>			104	2238	TR5
R46SX	4536	XR45	13	7773	UR6	104	3623	BPR6EFS
R46SZ	6945	UR45						

NOTE: Cross references are provided as a GUIDE ONLY. Due to differences in design / materials, products produced by various mfrs may have different specifications. Please refer to specific application guide for proper usage.

REMARQUE: Les références sont fournies en GUIDE UNIQUEMENT. En raison des différences de conception et de matériaux, des produits fabriqués par différents fabricants peuvent avoir des spécifications différentes. Veuillez vous référer au guide d'application spécifique pour l'utilisation correcte.



Competitor #	NGK Stock #	NGK Part #	Competitor #	NGK Stock #	NGK Part #	Competitor #	NGK Stock #	NGK Part #
Autolite			Autolite			Autolite		
104	3951	TR55	416	4210	B5HS	884	3951	TR55
104BP	2238	TR5	421	4322	BR8HS	915	6334	ZGR5C
104DP2	2238	TR5	422	4122	BR7HS	925	6334	ZGR5C
105	2238	TR5	424	7534	B6HS	935	2635	GR4
106	2238	TR5	425	3722	BR5HS	935	7734	BPR5ES
106BP	2238	TR5	426	3722	BR5HS	945	2635	GR4
124	3323	AR6FS	436	3212	B-6L	945	7734	BPR5ES
127	3323	AR6FS	437	3112	B-4L	965	6945	UR45
143	7052	YR5	483	1094	BR7EFS	966	4536	XR45
144	7052	YR5	494	3212	B-6L	985	4043	ZFR4F-11
145	7052	YR5	495	3212	B-6L	985BP	4043	ZFR4F-11
145BP	7052	YR5	497	3112	B-4L	985DP2	4043	ZFR4F-11
146	7052	YR5	515	4111	BP5HS	996	3212	B-6L
147	7052	YR5	516	4111	BP5HS	1101	3704	Y-918J
156	2438	WR5	517	3611	BP4HS	1102	3473	Y-924J
166	2438	WR5	535	4210	B5HS	1103	3473	Y-924J
203	2771	UR5	566	4536	XR45	1104	3704	Y-918J
215	3212	B-6L	567	4536	XR45	1108	97928	Y1037J
217	3112	B-4L	584	3323	AR6FS	1111	97928	Y1037J
218	3112	B-4L	603	3951	TR55	1113	97788	Y1032AS
255	3210	B-4	604	3951	TR55	1114	97190	Y4002J
255BP	3210	B-4	605	3951	TR55	1116	5909	Y-732J
255DP	3210	B-4	605BP	3951	TR55	1117	97190	Y4002J
273	7331	BP6HS	605DP2	3951	TR55	1118	4705	Y-745U
274	7331	BP6HS	606	3951	TR55	1119	5616	Y-408JS
275	4111	BP5HS	606DP2	3951	TR55	1120	90046	Y1033AS
276	4111	BP5HS	646	4268	GR45	2272	3010	AB-7
283	6422	BPR7HS	646BP	4268	GR45	2414	3630	B10EG
284	7022	BPR6HS	646DP2	4268	GR45	2415	3530	B9EG
295	3210	B-4	664	2248	UR55	2416	3430	B8EG
295DP	3210	B-4	665	6945	UR45	2417	6664	BR7EIX
297	3210	B-4	666	6945	UR45	2453	6692	BR10HIX
302	3522	BR6S	666BP	6945	UR45	2526	2329	BR8EQ-14
303	3522	BR6S	666DP2	6945	UR45	2543	7060	TR5-1
304	3522	BR6S	667	6945	UR45	2544	7060	TR5-1
306	3210	B-4	683	7240	YR55	2544BP	7060	TR5-1
317	3210	B-4	684	7240	YR55	2545	7060	TR5-1
344	3323	AR6FS	685	7240	YR55	2545BP	7060	TR5-1
356	3210	B-4	687	7240	YR55	2545DP2	7060	TR5-1
357	3210	B-4	704	2771	UR5	2546	7060	TR5-1
363	3522	BR6S	723	2771	UR5	2546BP	7060	TR5-1
372	7909	AB-8	724	2771	UR5	2585	2635	GR4
373	3010	AB-7	725	6630	UR4	2585	7734	BPR5ES
374	3010	AB-7	726	6630	UR4	2592	7928	B10ES
375	2910	AB-6	727	6630	UR4	2594	2611	B9ES
376	2910	AB-6	744	2438	WR5	2611	6596	R5671A-11
377	2910	AB-6	745	2438	WR5	2611	7928	B10ES
378	2910	AB-6	746	2438	WR5	2612	2611	B9ES
386	2910	AB-6	747	2438	WR5	2613	2611	B9ES
393	1111	B7ES	763	7060	TR5-1	2614	2411	B8ES
394	7432	B6ES	764	7060	TR5-1	2615	1111	B7ES
395	6410	B5ES	764BP	7060	TR5-1	2616	7432	B6ES
396	6410	B5ES	764DP2	7060	TR5-1	2626	5777	BUR9EQ
397	6410	B5ES	765	2238	TR5	2626	6917	BUR7EQ
402	5422	BR8ES	765BP	2238	TR5	2635	5510	B8HS
403	4922	BR6ES	765DP2	2238	TR5	2636	5110	B7HS
404	4922	BR6ES	766	2238	TR5	2653	5110	B7HS
404BP	4922	BR6ES	767	7060	TR5-1	2654	5110	B7HS
405	5866	BR5ES	784	3323	AR6FS	2655	7534	B6HS
406	5866	BR5ES	804	3323	AR6FS	2656	4210	B5HS
411	5810	B9HS	847	4536	XR45	2675	3212	B-6L
413	5110	B7HS	847BP	4536	XR45	2676	3212	B-6L
414	7534	B6HS	847DP2	4536	XR45	2677	3112	B-4L
415	4210	B5HS	865	2238	TR5	2695	7909	AB-8

NOTE: Cross references are provided as a GUIDE ONLY. Due to differences in design / materials, products produced by various mfrs may have different specifications. Please refer to specific application guide for proper usage.

412 NOTA: El cruce de referencias servirá únicamente como guía. Las diferencias en diseño, materiales y los productos utilizados para su elaboración pueden variar dependiendo del fabricante. Para obtener la aplicación correcta de su vehículo, por favor referirse a la sección correspondiente dentro de esta guía.



Competitor #	NGK Stock #	NGK Part #	Competitor #	NGK Stock #	NGK Part #	Competitor #	NGK Stock #	NGK Part #
Autolite			Autolite			Autolite		
2696	3010	AB-7	3565	2238	TR5	4162	5329	DPR9EA-9
2697	2910	AB-6	3604	6945	UR45	4163	2923	DR8ES-L
2715	7112	D8HA	3605	6945	UR45	4163DP	2923	DR8ES-L
2716	6512	D6HA	3606	6945	UR45	4163DP2	2923	DR8ES-L
2735	6512	D6HA	3607	6945	UR45	4164	3932	DCPR7E
2744	5370	BUR4EB-11	3623	7240	YR55	4164	4339	DCPR8E
2755	2120	D8EA	3625	7240	YR55	4164	7912	D7EA
2772	7909	AB-8	3627	7240	YR55	4164DP	7912	D7EA
2773	3010	AB-7	3647	4536	XR45	4173	7112	D8HA
2775	2910	AB-6	3684	4122	BR7HS	4193	4629	C7HSA
2794	6821	C8HSA	3686	3922	BR6HS	4203	7223	CR7HS
2795	4629	C7HSA	3702	5722	BR9ES	4251	2912	BP8ES
2796	3228	C6HSA	3703	5722	BR9ES	4252	1034	BP7ES
2892	2522	BUHX	3704	5422	BR8ES	4253	7333	BP6ES
2974	7321	BPM7A	3705	4922	BR6ES	4261	3923	BPR8ES
2974DP	7321	BPM7A	3706	4922	BR6ES	4263	2851	GR5
3017	3210	B-4	3724	2238	TR5	4263	7734	BPR5ES
3035	2910	AB-6	3854	2120	D8EA	4265	7734	BPR5ES
3036	6945	UR45	3885	6334	ZGR5C	4265	7832	BP5ES
3116	2910	AB-6	3896	6334	ZGR5C	4265DP	7832	BP5ES
3203	2851	GR5	3912	4644	BKR7E	4265DP2	7832	BP5ES
3203	7131	BPR6ES	3922	2288	BKR6EK	4275	2298	R5670-5
3204	2851	GR5	3922	5509	BCPR7ET	4302	1275	CR8E
3204	7131	BPR6ES	3922	6987	ZFR6F-11G	4302DP	1275	CR8E
3205	2635	GR4	3922	7969	BKR6EKUB	4303	4578	CR7E
3205	7734	BPR5ES	3923	2756	BKR6E-11	4303DP	4578	CR7E
3206	2635	GR4	3923	4952	BKR7ES-11	4316	3212	B-6L
3206	7734	BPR5ES	3924	5553	BKR6ES-11	5125	4652	WR4-1
3207	2635	GR4	3924	6953	BKR5E-11	5125BP	4652	WR4-1
3207	7734	BPR5ES	3924	7373	FR5	5125DP2	4652	WR4-1
3224	3332	XR5	3924	7938	BKR5E	5143	7060	TR5-1
3225	3332	XR5	3924BP	7938	BKR5E	5144	7060	TR5-1
3226	3332	XR5	3926	2382	BKR5ES-11	5144BP	7060	TR5-1
3227	3332	XR5	3926BP	2382	BKR5ES-11	5144DP2	7060	TR5-1
3243	2238	TR5	3926DP2	2382	BKR5ES-11	5184	7938	BKR5E
3243	3623	BPR6EFS	3927	2382	BKR5ES-11	5184BP	7938	BKR5E
3244	2238	TR5	3931	6596	R5671A-11	5224	1041	ZFR6A-11
3244	3623	BPR6EFS	3954	7162	DR8EA	5224	6987	ZFR6F-11G
3245	2238	TR5	3964	2923	DR8ES-L	5224BP	1041	ZFR6A-11
3246	2238	TR5	3983	6945	UR45	5224DP2	1041	ZFR6A-11
3265	7052	YR5	3985	6945	UR45	5243	2238	TR5
3266	7052	YR5	4043	7133	BPR6ES-11	5243	3623	BPR6EFS
3267	7052	YR5	4051	4897	R7435-10	5245	2238	TR5
3286	2438	WR5	4051	7928	B10ES	5245	3754	TR4
3303	2771	UR5	4052	2611	B9ES	5245BP	3754	TR4
3325	3212	B-6L	4053	2611	B9ES	5245DP2	3754	TR4
3327	3112	B-4L	4054	5122	BR7ES	5285	7052	YR5
3364	7022	BPR6HS	4054DP2	5122	BR7ES	5325	92174	LZFR5C-11
3382	3522	BR6S	4055	4922	BR6ES	5503	2756	BKR6E-11
3383	3522	BR6S	4056	7432	B6ES	5503	5553	BKR6ES-11
3384	3522	BR6S	4062	5722	BR9ES	5503DP2	2756	BKR6E-11
3386	3522	BR6S	4063	5722	BR9ES	5682	6799	LZKAR7A
3388	3522	BR6S	4092	5110	B7HS	5923	4644	BKR7E
3404	3323	AR6FS	4092DP	5110	B7HS	5924	6962	BKR6E
3426	3522	BR6S	4093	5110	B7HS	6003	92174	LZFR5C-11
3462	5122	BR7ES	4093DP	5110	B7HS	9062	7517	BUR6ET
3463	4922	BR6ES	4113	7331	BP6HS	9063	7517	BUR6ET
3464	4922	BR6ES	4113DP2	7331	BP6HS	AP23	3547	UR5GP
3465	5866	BR5ES	4114	7331	BP6HS	AP24	3547	UR5GP
3466	5866	BR5ES	4123	7022	BPR6HS	AP24DP2	3547	UR5GP
3485	3722	BR5HS	4132	2120	D8EA	AP25	2869	UR4GP
3486	3722	BR5HS	4143	2923	DR8ES-L	AP25	3207	UR45GP
3507	3212	B-6L	4152	6629	DP9EA-9	AP25DP2	2869	UR4GP
3547	4536	XR45	4153	5829	DP8EA-9	AP26	2869	UR4GP

**NOTE:** Cross references are provided as a GUIDE ONLY. Due to differences in design / materials, products produced by various mfrs may have different specifications. Please refer to specific application guide for proper usage.

**REMARQUE:** Les références sont fournies en GUIDE UNIQUEMENT. En raison des différences de conception et de matériaux, des produits fabriqués par différents fabricants peuvent avoir des spécifications différentes. Veuillez vous référer au guide d'application spécifique pour l'utilisation correcte.





Competitor #	NGK Stock #	NGK Part #	Competitor #	NGK Stock #	NGK Part #	Competitor #	NGK Stock #	NGK Part #
Autolite			Autolite			Autolite		
AP26	3207	UR45GP	AP5144	3716	TR5-1GP	APP3923DP2	4639	PFR6L-11
AP26DP2	3207	UR45GP	AP5144	7159	TR55-1GP	APP3924	2300	PFR5B-11
AP45	7510	WR5IX	AP5144DP2	3716	TR5-1GP	APP3924DP2	2300	PFR5B-11
AP46	7510	WR5IX	AP5145	3716	TR5-1GP	APP3926	2647	PFR5G-11
AP62	4055	BPR7EIX	AP5145	7159	TR55-1GP	APP5125	7510	WR5IX
AP63	7084	BPR6EGP	AP5145DP2	3716	TR5-1GP	APP5143	7159	TR55-1GP
AP63DP2	7084	BPR6EGP	AP5164	3186	TR5GP	APP5144	3186	TR5GP
AP64	7082	BPR5EGP	AP5184	3403	TR55GP	APP5144	3716	TR5-1GP
AP64	7084	BPR6EGP	AP5224	7094	ZFR6AGP	APP5144	7159	TR55-1GP
AP64DP2	7084	BPR6EGP	AP5224	7100	ZFR6FGP	APP5144DP2	3716	TR5-1GP
AP65	2763	GR4GP	AP5224DP2	7094	ZFR6AGP	APP5145	7243	TR5-1IX
AP65	7082	BPR5EGP	AP5243	3403	TR55GP	APP5224	3271	PZFR6F-11
AP65DP2	7082	BPR5EGP	AP5245	3186	TR5GP	APP5224	4363	PZFR5F-11
AP66	7082	BPR5EGP	AP5245	3403	TR55GP	APP5224DP2	3271	PZFR6F-11
AP85	7355	XR5IX	AP5245DP2	3403	TR55GP	APP5243	6579	PTR5F-11
AP86	7189	XR4IX	AP5263	5019	LTR5GP	APP5245	1209	PTR4G-15
AP103	3186	TR5GP	AP5263DP2	5019	LTR5GP	APP5245DP2	1209	PTR4G-15
AP103	5141	TR6GP	AP5325	1483	LFR6CGP	APP5263	4998	PLZTR5A-13
AP103DP2	5141	TR6GP	AP5325	5018	LFR5AGP	APP5325	6240	PLFR5A-11
AP104	3186	TR5GP	AP5364	5019	LTR5GP	APP5344	2467	PTR5A-13
AP104	3403	TR55GP	AP5405	7100	ZFR6FGP	APP5364	2467	PTR5A-13
AP104DP2	3186	TR5GP	AP5405DP2	7100	ZFR6FGP	APP5364DP2	2467	PTR5A-13
AP105	3186	TR5GP	AP5426	3381	LZTR5AGP	APP5405	7781	ZFR5LP-13G
AP105DP2	3186	TR5GP	AP5426DP2	3381	LZTR5AGP	APP5426	4998	PLZTR5A-13
AP106	2815	TR4GP	AP5503	7088	BCPR6EGP	APP5503	4793	PFR6G
AP106	3186	TR5GP	AP5503DP2	7088	BCPR6EGP	APP5683	4912	ILKAR7B11
AP124	7510	WR5IX	APP23	3547	UR5GP	APP392411	3440	BKR5EP-11
AP145	2953	YR5GP	APP24	3547	UR5GP	AR23	2771	UR5
AP145DP2	7516	YR5IX	APP24DP2	3547	UR5GP	AR24	2771	UR5
AP303	3332	XR5	APP25	3547	UR5GP	AR25	6630	UR4
AP403	7084	BPR6EGP	APP25DP2	3547	UR5GP	AR51	3923	BPR8ES
AP404	7084	BPR6EGP	APP26	3207	UR45GP	AR52	5534	BPR7ES
AP425	3419	BR6HIX	APP45	7510	WR5IX	AR53	7333	BP6ES
AP605	3403	TR55GP	APP46	7510	WR5IX	AR103	3623	BPR6EFS
AP605DP2	3403	TR55GP	APP63	7084	BPR6EGP	AR103	4177	TR6
AP606	3403	TR55GP	APP64	3971	BPR5EP-11	AR764	2238	TR5
AP606DP2	3403	TR55GP	APP64DP2	3971	BPR5EP-11	AR2593	2611	B9ES
AP646	3142	GR45GP	APP65	2763	GR4GP	AR2594	2611	B9ES
AP646DP2	3142	GR45GP	APP65	7082	BPR5EGP	AR3912	4644	BKR7E
AP664	3547	UR5GP	APP66	7082	BPR5EGP	AR3923	6962	BKR6E
AP665	3207	UR45GP	APP103	5598	PTR6D-13	AR3924	6962	BKR6E
AP666	3207	UR45GP	APP103DP2	5598	PTR6D-13	AR4132	2120	D8EA
AP666DP2	3207	UR45GP	APP104	3784	PTR5D-10	AR4152	6629	DP9EA-9
AP764	3716	TR5-1GP	APP104	7740	PTR5C-13	AR5624	4216	R0045Q-10
AP765	3716	TR5-1GP	APP104DP2	3784	PTR5D-10	SM4252DP	5534	BPR7ES
AP766	3716	TR5-1GP	APP105	3784	PTR5D-10	XP24	7177	UR5IX
AP847	7293	XR45IX	APP105DP2	3186	TR5GP	XP24DP2	7177	UR5IX
AP985	3459	ZFR5N	APP106	3784	PTR5D-10	XP25	7177	UR5IX
AP985	7098	ZFR5FGP	APP145	2953	YR5GP	XP25DP2	7177	UR5IX
AP985DP2	7098	ZFR5FGP	APP605	6579	PTR5F-11	XP26	7559	UR45IX
AP2543	3716	TR5-1GP	APP605DP2	3403	TR55GP	XP26DP2	7559	UR45IX
AP2544	3716	TR5-1GP	APP646	3142	GR45GP	XP63	6637	BPR6EIX
AP2545	3716	TR5-1GP	APP646	7082	BPR5EGP	XP63DP2	6637	BPR6EIX
AP2546	3716	TR5-1GP	APP664	3207	UR45GP	XP64	6637	BPR6EIX
AP2744	7082	BPR5EGP	APP666	3207	UR45GP	XP64DP2	6637	BPR6EIX
AP3923	7088	BCPR6EGP	APP764	3186	TR5GP	XP103	7164	TR55IX
AP3923	7092	BKR6EGP	APP764	3403	TR55GP	XP103	7397	TR5IX
AP3923DP2	7088	BCPR6EGP	APP765	3186	TR5GP	XP103DP2	7397	TR5IX
AP3924	7088	BCPR6EGP	APP847	4536	XR45	XP104	7164	TR55IX
AP3924	7090	BKR5EGP	APP985	3459	ZFR5N	XP104	7397	TR5IX
AP3924DP2	7088	BCPR6EGP	APP2544	3716	TR5-1GP	XP104DP2	7397	TR5IX
AP5125	7510	WR5IX	APP2545	3716	TR5-1GP	XP105	7164	TR55IX
AP5143	3716	TR5-1GP	APP2546	3716	TR5-1GP	XP105	7397	TR5IX
AP5143	7159	TR55-1GP	APP3923	4639	PFR6L-11	XP105DP2	7397	TR5IX

**NOTE:** Cross references are provided as a GUIDE ONLY. Due to differences in design / materials, products produced by various mfrs may have different specifications. Please refer to specific application guide for proper usage.

414 **NOTA:** El cruce de referencias servirá únicamente como guía. Las diferencias en diseño, materiales y los productos utilizados para su elaboración pueden variar dependiendo del fabricante. Para obtener la aplicación correcta de su vehículo, por favor referirse a la sección correspondiente dentro de esta guía.





Competitor #	NGK Stock #	NGK Part #	Competitor #	NGK Stock #	NGK Part #	Competitor #	NGK Stock #	NGK Part #
<b>Autolite</b>			<b>Autolite</b>			<b>Beck Arnley</b>		
XP106	7397	TR5IX	XS63	6637	BPR6EIX	1765031	7534	B6HS
XP605	7164	TR55IX	XS63DP	6637	BPR6EIX	1765045	5044	BR8EIX
XP605DP2	7164	TR55IX	XS65	6597	BPR5EIX	1765052	4210	B5HS
XP606	7164	TR55IX	XS65DP	6597	BPR5EIX	1765058	6410	B5ES
XP606DP2	7164	TR55IX	XS85	7355	XR5IX	1765067	7832	BP5ES
XP646	2115	BPR5EIX-11	XS85DP	7355	XR5IX	1765070	7333	BP6ES
XP646	3142	GR45GP	XS985	4043	ZFR4F-11	1765073	7331	BP6HS
XP646	97382	GR4IX	XS985	4363	PZFR5F-11	1765075	1034	BP7ES
XP646DP2	2115	BPR5EIX-11	XS985DP	4043	ZFR4F-11	1765077	2912	BP8ES
XP666	7559	UR45IX	XS3922	5690	BCPR7EIX	1765082	7734	BPR5ES
XP985	2477	ZFR5FIX-11	XS3922DP	5690	BCPR7EIX	1765084	7131	BPR6ES
XP985DP2	2477	ZFR5FIX-11	XS3923	6418	BKR6EIX	1765095	4111	BP5HS
XP3922	5690	BCPR7EIX	XS3923DP	6418	BKR6EIX	1765096	1233	BPR5EY
XP3923	3764	BKR6EIX-11	XS3924	6418	BKR6EIX	1765106	7133	BPR6ES-11
XP3923	4589	IFR6T11	XS3924DP	6418	BKR6EIX	1765107	7634	BPR5ES-11
XP3923	6418	BKR6EIX	XS4062	3981	BR9EIX	1765111	5877	BR7ET
XP3923DP2	6418	BKR6EIX	XS4062DP	3981	BR9EIX	1765112	5866	BR5ES
XP3924	5464	BKR5EIX-11	XS4063	5044	BR8EIX	1765113	7022	BPR6HS
XP3924	6341	BKR5EIX	XS4063DP	5044	BR8EIX	1765117	4922	BR6ES
XP3924DP2	5464	BKR5EIX-11	XS4064	6664	BR7EIX	1765123	5422	BR8ES
XP3926	5464	BKR5EIX-11	XS4064DP	6664	BR7EIX	1765124	6612	BR8ET
XP5143	7243	TR5-1IX	XS4092	7067	BR7HIX	1765132	6945	UR45
XP5144	7243	TR5-1IX	XS4092DP	7067	BR7HIX	1765144	2329	BR8EQ-14
XP5144DP2	7243	TR5-1IX	XS4093	7067	BR7HIX	1765148	6931	BR6EB-L-11
XP5145	7243	TR5-1IX	XS4093DP	7067	BR7HIX	1765150	6937	BPR5EY-11
XP5145DP2	7243	TR5-1IX	XS4123DP	4085	BPR6HIX	1765151	1233	BPR5EY
XP5224	2477	ZFR5FIX-11	XS4162	5545	DPR9EIX-9	1765152	6937	BPR5EY-11
XP5224	3657	IZFR5K11	XS4163	6681	DR8EIX	1765155	7037	BUR6EB-11
XP5224	6441	ZFR6FIX-11	XS4163DP	6681	DR8EIX	1765156	3971	BPR5EP-11
XP5224	6994	IZFR6K11	XS4164	5686	DR7EIX	1765158	4690	BUR6EA-11
XP5224DP2	2477	ZFR5FIX-11	XS4164DP	5686	DR7EIX	1765159	5044	BR8EIX
XP5243	7164	TR55IX	XS4302	4218	CR8EIX	1765160	6696	BCPR5ES-11
XP5243	7397	TR5IX	XS4302DP	4218	CR8EIX	1765161	6779	BCPR6ES-11
XP5243DP2	7164	TR55IX	XS4303	7385	CR7EIX	1765162	5632	BCPR6E-11
XP5245	7164	TR55IX	XS4303DP	7385	CR7EIX	1765164	5534	BPR7ES
XP5245DP2	7164	TR55IX	XS5224	6341	BKR5EIX	1765165	7226	BPR7ES-11
XP5263	2314	LZTR5AIX-13	XS5224DP	6341	BKR5EIX	1765167	2097	BCPR5EP-11
XP5263DP2	2314	LZTR5AIX-13	XST3924	3696	BKR6EY	1765168	5777	BUR9EQ
XP5325	4469	LFR5AIX-11	XST3924DP	3696	BKR6EY	1765170	6735	BUR5EB-11
XP5325DP2	4469	LFR5AIX-11	XST3926	7390	BKR5EY	1765171	6261	BPR6EY-11
XP5363	4344	LTR5IX-11	XST3926DP	7390	BKR5EY	1765173	5077	ZGR5A
XP5363	6509	LTR6IX-11	XST4055	5122	BR7ES	1765177	5370	BUR4EB-11
XP5364	4344	LTR5IX-11	XST4055DP	5122	BR7ES	1765178	2438	WR5
XP5364DP2	4344	LTR5IX-11	XST4265	1233	BPR5EY	1765179	6630	UR4
XP5405	2477	ZFR5FIX-11	<b>Beck Arnley</b>			1765180	2238	TR5
XP5405DP2	2477	ZFR5FIX-11	1761011	1239	Y-207T	1765181	1263	BP6ET
XP5426	2314	LZTR5AIX-13	1761033	3473	Y-924J	1765182	4563	BCP6ET
XP5426DP2	2314	LZTR5AIX-13	1761034	1232	Y-112TS	1765183	2441	BCPR5EY-11
XP5503	6418	BKR6EIX	1761035	3829	Y-204TS1	1765184	6637	BPR6EIX
XP5503DP2	6418	BKR6EIX	1761036	4573	Y-204RS	1765185	4497	BCPR6EP-N-11
XP5682	6043	ILZKAR7A10	1761037	6929	Y-810	1765186	4045	PFR6A-11
XP5683	4912	ILKAR7B11	1761038	1250	Y-208T	1765188	6262	BCPR6EY-N-11
XP5684	9029	DILKAR6A11	1761039	2930	Y-117RS	1765190	2851	GR5
XP5701	93911	LKR7AIX	1761040	1132	Y-112RS1	1765191	4536	XR45
XP5702	93911	LKR7AIX	1761041	2161	Y-115R1	1765192	7052	YR5
XP5703	93911	LKR7AIX	1761042	1229	Y-107R	1765194	2635	GR4
XP5863	6509	LTR6IX-11	1761044	3473	Y-924J	1765195	2756	BKR6E-11
XP6003	97606	PLZFR5B13EG	1761046	1229	Y-107R	1765197	6917	BUR7EQ
XP6043	97408	LZTR6AP11EG	1761047	3473	Y-924J	1765198	3573	PGR5A-11
XP6203	93815	SILZKR6B10E	1765002	7432	B6ES	1765199	5690	BCPR7EIX
XS61	6684	BPR8EIX	1765004	1111	B7ES	1765200	2950	BCPR5EP-8
XS61DP	6684	BPR8EIX	1765006	5110	B7HS	1765201	5275	BCPR6EP-N-8
XS62	4055	BPR7EIX	1765008	2411	B8ES	1765202	3350	BCPR6EP-11
XS62DP	4055	BPR7EIX	1765012	2611	B9ES	1765203	6917	BUR7EQ

**NOTE:** Cross references are provided as a GUIDE ONLY. Due to differences in design / materials, products produced by various mfrs may have different specifications. Please refer to specific application guide for proper usage.

**REMARQUE:** Les références sont fournies en GUIDE UNIQUEMENT. En raison des différences de conception et de matériaux, des produits fabriqués par différents fabricants peuvent avoir des spécifications différentes. Veuillez vous référer au guide d'application spécifique pour l'utilisation correcte.



Competitor #	NGK Stock #	NGK Part #	Competitor #	NGK Stock #	NGK Part #	Competitor #	NGK Stock #	NGK Part #
<b>Beck Arnley</b>			<b>Beck Arnley</b>			<b>Bosch</b>		
1765204	1041	ZFR6A-11	1765285	7808	BKUR6ET	4035	5866	BR5ES
1765205	1266	BCPR5EY	1765286	5689	BCPR6EIX	4036	5858	XR4
1765207	4936	ZFR5D-11	1765288	7164	TR55IX	4037	2763	GR4GP
1765208	5553	BKR6ES-11	1765289	4642	PFR5J-11	4038	5534	BPR7ES
1765210	4014	PFR6B-11	1765290	7397	TR5IX	4039	3716	TR5-1GP
1765211	4435	ZFR5E-11	1765291	3903	BPR6EIX-11	4041	7164	TR55IX
1765212	3696	BKR6EY	1765292	5689	BCPR6EIX	4201	2756	BKR6E-11
1765214	4291	ZFR6F-11	1765294	5122	BR7ES	4201	3764	BKR6EIX-11
1765216	2978	BKR6EP-11	1765295	5459	PFR5L-11	4202	5464	BKR5EIX-11
1765217	2215	BKR6EP-8	1765296	4302	BKR5EKP-11	4202	6953	BKR5E-11
1765218	2526	BKR5EYA-11	1765297	2890	BKR5EKUP	4202	7090	BKR5EGP
1765221	6612	BR8ET	1765298	3452	BKR6EKP-11	4203	3459	ZFR5N
1765222	6130	BCPR5ES	1765299	4589	IFR6T11	4204	2771	UR5
1765223	5084	ZFR5A-11	1765300	2761	PFR5G-13E	4204	7401	UR4IX
1765224	2262	ZFR5F-11	1765301	2341	PFR6G-13E	4205	3186	TR5GP
1765225	1273	BCPR5E-11	1765302	4639	PFR6L-11	4205	7397	TR5IX
1765226	6962	BKR6E	1765303	4853	PFR7B	4206	2953	YR5GP
1765227	3440	BKR5EP-11	1765304	2467	PTR5A-13	4206	7516	YR5IX
1765229	1095	BCPR7ES-11	1765305	4363	PZFR5F-11	4207	2869	UR4GP
1765230	7912	D7EA	1765306	2115	BPR5EIX-11	4207	7401	UR4IX
1765232	7373	FR5	1765307	3177	BR6EF	4208	2869	UR4GP
1765233	4268	GR45	1765308	7969	BKR6EKUB	4208	7401	UR4IX
1765234	6953	BKR5E-11	1765310	7517	BUR6ET	4209	3207	UR45GP
1765236	2391	BKR5E-N-11	<b>Beru</b>			4209	7559	UR45IX
1765237	5555	PFR6G-11	12ZR6SP02	90223	PLZKBR7B8DG	4211	7300	TR4IX
1765238	2743	PFR6J-11	12ZR6SP03	95770	ILZKBR7B8DG	4211	7397	TR5IX
1765239	2867	PFR5B-11B	12ZR6SPP2-1	95770	ILZKBR7B8DG	4212	7159	TR55-1GP
1765240	2087	BKR5EYA	12ZR-8STP	90223	PLZKBR7B8DG	4212	7316	TR55-1IX
1765241	2771	UR5	<b>Bosch</b>			4214	3722	BR5HS
1765242	1094	BR7EFS	4000	7510	WR5IX	4215	4922	BR6ES
1765244	2300	PFR5B-11	4001	2756	BKR6E-11	4216	6637	BPR6EIX
1765245	1094	BR7EFS	4002	6953	BKR5E-11	4216	7131	BPR6ES
1765245	3346	BR7EF	4003	3459	ZFR5N	4217	3903	BPR6EIX-11
1765246	7558	ZFR5F	4004	2771	UR5	4217	7084	BPR6EGP
1765247	6418	BKR6EIX	4005	3186	TR5GP	4218	6597	BPR5EIX
1765248	2271	PFR5C-11	4006	2953	YR5GP	4218	7734	BPR5ES
1765251	5688	BCPR5EIX	4007	2869	UR4GP	4219	2115	BPR5EIX-11
1765252	2397	BKUR6ET-10	4008	2869	UR4GP	4219	7634	BPR5E-11
1765253	5584	ZFR5J-11	4009	3207	UR45GP	4220	6597	BPR5EIX
1765254	4043	ZFR4F-11	4010	3207	UR45GP	4220	7734	BPR5ES
1765255	4764	BUR7EQP	4011	7397	TR5IX	4221	2115	BPR5EIX-11
1765256	5255	BUR9EQP	4012	7159	TR55-1GP	4221	7634	BPR5E-11
1765257	4115	PFR6G-13	4013	3716	TR5-1GP	4222	4536	XR45
1765258	3481	DCPR6E	4014	3722	BR5HS	4222	7293	XR45IX
1765260	2330	BCPR6ES	4015	4922	BR6ES	4223	4536	XR45
1765261	7060	TR5-1	4016	7131	BPR6ES	4225	6637	BPR6EIX
1765262	3964	BKR5EKU	4017	7084	BPR6EGP	4225	7131	BPR6ES
1765263	7390	BKR5EY	4018	7734	BPR5ES	4226	7510	WR5IX
1765264	4363	PZFR5F-11	4019	7634	BPR5E-11	4227	6418	BKR6EIX
1765265	2288	BKR6EK	4020	7734	BPR5ES	4227	7092	BKR6EGP
1765266	5509	BCPR7ET	4021	7634	BPR5E-11	4228	6418	BKR6EIX
1765267	5464	BKR5EIX-11	4022	4536	XR45	4228	6962	BKR6E
1765268	3951	TR55	4023	4536	XR45	4229	4435	ZFR5E-11
1765269	2382	BKR5ES-11	4024	2771	UR5	4230	4363	PZFR5F-11
1765272	3141	PFR6L-13	4025	7131	BPR6ES	4232	7022	BPR6HS
1765273	2647	PFR5G-11	4026	7510	WR5IX	4233	4922	BR6ES
1765274	7808	BKUR6ET	4027	7092	BKR6EGP	4235	5866	BR5ES
1765276	3967	BKR5EKB-11	4028	6962	BKR6E	4236	5858	XR4
1765277	3500	PFR6B	4029	4435	ZFR5E-11	4236	7189	XR4IX
1765280	3546	PFR6N-11	4030	4363	PZFR5F-11	4237	2763	GR4GP
1765281	6341	BKR5EIX	4031	3623	BPR6EFS	4237	97382	GR4IX
1765282	3764	BKR6EIX-11	4032	7022	BPR6HS	4238	3785	BPR7ES SOLID
1765283	6597	BPR5EIX	4033	4922	BR6ES	4238	5534	BPR7ES
1765284	3741	PZFR5F	4034	5077	ZGR5A	4301	2890	BKR5EKUP

**NOTE:** Cross references are provided as a GUIDE ONLY. Due to differences in design / materials, products produced by various mfrs may have different specifications. Please refer to specific application guide for proper usage.

416 **NOTA:** El cruce de referencias servirá únicamente como guía. Las diferencias en diseño, materiales y los productos utilizados para su elaboración pueden variar dependiendo del fabricante. Para obtener la aplicación correcta de su vehículo, por favor referirse a la sección correspondiente dentro de esta guía.



Competitor #	NGK Stock #	NGK Part #	Competitor #	NGK Stock #	NGK Part #	Competitor #	NGK Stock #	NGK Part #
<b>Bosch</b>								
4302	3547	UR5GP	6705	7092	BKR6EGP	7416	3481	DCPR6E
4304	3784	PTR5D-10	6706	3403	TR55GP	7416	4339	DCPR8E
4305	3784	PTR5D-10	6707	7098	ZFR5FGP	7420	97287	ITR5H13
4306	3573	PGR5A-11	6708	3207	UR45GP	7421	1465	IZTR5B11
4307	3573	PGR5A-11	6708	3547	UR5GP	7422	4696	IFR5D10
4309	3186	TR5GP	6709	3186	TR5GP	7426	6458	PPR6Q
4310	6637	BPR6EIX	6709	3403	TR55GP	7431	1961	ILZKR7A
4311	3547	UR5GP	6710	3403	TR55GP	7434	90654	SILZKFR8E7S
4312	2890	BKR5EKUP	6710	5141	TR6GP	7500	7131	BPR6ES
4313	3587	PLTR6A-10G	6711	3381	LZTR5AGP	7500	7333	BP6ES
4314	90083	LTR5BI-13	6711	5017	LZTR4AGP	7501	2851	GR5
4314	90607	ILTR5K13	6711	5306	LZTR4A-11	7501	7131	BPR6ES
4315	2467	PTR5A-13	6712	2869	UR4GP	7502	3722	BR5HS
4316	5018	LFR5AGP	6712	3207	UR45GP	7502	4210	B5HS
4417	3764	BKR6EIX-11	6713	5018	LFR5AGP	7503	4111	BP5HS
4418	5464	BKR5EIX-11	6714	6994	IZFR6K11	7503	6222	BPR5HS
4419	2477	ZFR5FIX-11	6714	7772	PFR7G-11S	7504	5866	BR5ES
4428	7100	ZFR6FGP	6715	7159	TR55-1GP	7504	6410	B5ES
4431	5018	LFR5AGP	6716	5019	LTR5GP	7505	4006	BPR5ES SOLID
4448	7177	UR5IX	6717	7096	ZFR5EGP	7505	7734	BPR5ES
4449	7401	UR4IX	6717	7252	FR5-1	7506	2635	GR4
4457	3186	TR5GP	6718	2815	TR4GP	7506	7634	BPR5ES-11
4458	7164	TR55IX	6719	7100	ZFR6FGP	7506	7734	BPR5ES
4459	7164	TR55IX	6720	3381	LZTR5AGP	7507	2635	GR4
4469	7316	TR55-1IX	6720	4998	PLZTR5A-13	7507	7634	BPR5ES-11
4477	6637	BPR6EIX	6721	3657	IZFR5K11	7508	3332	XR5
4478	7214	GR5IX	6721	7098	ZFR5FGP	7508	3522	BR6S
4479	97382	GR4IX	6721	7100	ZFR6FGP	7509	5077	ZGR5A
4481	2314	LZTR5AIX-13	6722	3547	UR5GP	7510	5866	BR5ES
4482	2313	LZTR4AIX-11	6722	7966	UR6GP	7511	7734	BPR5ES
4488	4344	LTR5IX-11	6723	3186	TR5GP	7511	7832	BP5ES
4501	7658	IFR6J11	6724	7092	BKR6EGP	7512	2635	GR4
4502	7177	UR5IX	6725	7098	ZFR5FGP	7512	7734	BPR5ES
4503	3199	BKR6EQUP	6725	7100	ZFR6FGP	7513	2635	GR4
4504	97287	ITR5H13	6726	7090	BKR5EGP	7513	7634	BPR5ES-11
4505	4477	ITR6F13	6727	5019	LTR5GP	7514	4268	GR45
4506	6637	BPR6EIX	6728	5019	LTR5GP	7514	6937	BPR5EY-11
4507	6597	BPR5EIX	6728	6509	LTR6IX-11	7515	3522	BR6S
4508	4095	IZFR6F11	6729	3142	GR45GP	7516	5858	XR4
4509	1465	IZTR5B11	6730	7090	BKR5EGP	7517	4536	XR45
4510	6637	BPR6EIX	6730	7092	BKR6EGP	7519	5858	XR4
4511	7348	UR6IX	6731	1483	LFR6CGP	7520	4536	XR45
4512	7418	IFR5J11	6731	4904	ILFR6T11	7520	5858	XR4
4513	3787	ILTR6A-8G	6732	4998	PLZTR5A-13	7521	4536	XR45
4514	5581	ILTR5C11	6734	92145	LZFR5CI-11	7522	2635	GR4
4515	5581	ILTR5C11	6734	97606	PLZFR5B13EG	7522	5077	ZGR5A
6200	7510	WR5IX	6736	7082	BPR5EGP	7523	4268	GR45
6210	3207	UR45GP	6737	7084	BPR6EGP	7524	6962	BKR6E
6210	7559	UR45IX	6747	3403	TR55GP	7525	4435	ZFR5E-11
6213	3716	TR5-1GP	6752	95712	LZFR6AP11GS	7526	4043	ZFR4F-11
6213	7243	TR5-1IX	7401	7092	BKR6EGP	7527	5155	FR4
6224	2771	UR5	7402	4959	BKR6EKC	7527	7938	BKR5E
6224	7401	UR4IX	7403	5509	BCPR7ET	7528	4322	BR8HS
6231	3623	BPR6EFS	7404	2288	BKR6EK	7529	5722	BR9ES
6234	5077	ZGR5A	7405	2890	BKR5EKUP	7530	2411	B8ES
6239	3716	TR5-1GP	7406	3696	BKR6EY	7530	5422	BR8ES
6239	7243	TR5-1IX	7407	3735	BCPR6E	7531	5111	BP7HS
6241	7164	TR55IX	7408	3735	BCPR6E	7531	6422	BPR7HS
6701	3403	TR55GP	7409	7839	DR7EA	7533	5122	BR7ES
6701	5141	TR6GP	7410	2288	BKR6EK	7537	3522	BR6S
6702	7090	BKR5EGP	7411	5141	TR6GP	7544	7321	BPM7A
6703	2815	TR4GP	7412	2467	PTR5A-13	7545	7321	BPM7A
6703	3403	TR55GP	7413	6855	ZFR7F-11	7548	2910	AB-6
6704	3186	TR5GP	7415	7517	BUR6ET	7549	2910	AB-6

**NOTE:** Cross references are provided as a GUIDE ONLY. Due to differences in design / materials, products produced by various mfrs may have different specifications. Please refer to specific application guide for proper usage.

**REMARQUE:** Les références sont fournies en GUIDE UNIQUEMENT. En raison des différences de conception et de matériaux, des produits fabriqués par différents fabricants peuvent avoir des spécifications différentes. Veuillez vous référer au guide d'application spécifique pour l'utilisation correcte.



Competitor #	NGK Stock #	NGK Part #	Competitor #	NGK Stock #	NGK Part #	Competitor #	NGK Stock #	NGK Part #
Bosch			Bosch			Bosch		
7550	2438	WR5	7597	7331	BP6HS	7968	7052	YR5
7551	2438	WR5	7598	4922	BR6ES	7969	2771	UR5
7552	4652	WR4-1	7598	7432	B6ES	7970	2238	TR5
7553	2756	BKR6E-11	7599	4922	BR6ES	7971	2238	TR5
7553	7373	FR5	7601	3623	BPR6EFS	7972	7052	YR5
7554	6962	BKR6E	7602	3010	AB-7	7973	7240	YR55
7554	7373	FR5	7603	4644	BKR7E	7974	2683	TR55-1
7555	6962	BKR6E	7607	7734	BPR5ES	7975	6630	UR4
7555	7373	FR5	7700	3437	DR9EA	7976	6945	UR45
7556	2756	BKR6E-11	7700	5423	DR8ES	7978	2238	TR5
7557	5155	FR4	7701	3437	DR9EA	7979	3951	TR55
7557	6953	BKR5E-11	7701	5423	DR8ES	7980	3951	TR55
7558	3686	FR45	7704	2683	TR55-1	7981	7060	TR5-1
7559	7558	ZFR5F	7705	5084	ZFR5A-11	7982	7060	TR5-1
7560	5155	FR4	7707	5422	BR8ES	7983	7052	YR5
7560	7938	BKR5E	7722	5077	ZGR5A	7985	6630	UR4
7561	3459	ZFR5N	7770	3437	DR9EA	7986	6630	UR4
7561	4043	ZFR4F-11	7802	3522	BR6S	7987	6945	UR45
7562	1041	ZFR6A-11	7805	7734	BPR5ES	7988	6945	UR45
7562	2262	ZFR5F-11	7805	7832	BP5ES	7989	3754	TR4
7563	5424	BKR4E-11	7806	3210	B-4	7990	7060	TR5-1
7564	2771	UR5	7807	7677	BMR2A	7992	5534	BPR7ES
7565	2238	TR5	7812	7321	BPM7A	7993	7022	BPR6HS
7565	3623	BPR6EFS	7814	7773	UR6	7994	5306	LZTR4A-11
7566	3623	BPR6EFS	7816	4421	BKR4E	7995	7131	BPR6ES
7566	4177	TR6	7816	7938	BKR5E	7996	7534	B6HS
7567	3623	BPR6EFS	7817	5424	BKR4E-11	7997	7022	BPR6HS
7567	4177	TR6	7900	7131	BPR6ES	7998	4922	BR6ES
7568	7052	YR5	7902	3722	BR5HS	7999	4922	BR6ES
7569	2771	UR5	7903	6222	BPR5HS	8100	3440	BKR5EP-11
7569	6630	UR4	7904	5866	BR5ES	8100	4589	IFR6T11
7570	2238	TR5	7905	7734	BPR5ES	8101	2978	BKR6EP-11
7571	2238	TR5	7907	7634	BPR5ES-11	8103	7740	PTR5C-13
7572	7052	YR5	7908	3522	BR6S	8104	3784	PTR5D-10
7573	7240	YR55	7909	5077	ZGR5A	8105	4363	PZFR5F-11
7574	2238	TR5	7911	7734	BPR5ES	8107	2467	PTR5A-13
7575	6630	UR4	7913	7634	BPR5ES-11	8108	93858	TR5BP12
7576	6945	UR45	7914	6937	BPR5EY-11	8109	6994	IZFR6K11
7577	6945	UR45	7915	3522	BR6S	8110	6240	PLFR5A-11
7578	2238	TR5	7916	5858	XR4	8111	7740	PTR5C-13
7579	2238	TR5	7918	3623	BPR6EFS	8112	3271	PZFR6F-11
7579	3951	TR55	7919	5858	XR4	8112	3657	IZFR5K11
7580	3951	TR55	7920	5858	XR4	8113	7740	PTR5C-13
7581	7060	TR5-1	7921	4536	XR45	8114	2467	PTR5A-13
7582	7060	TR5-1	7922	5077	ZGR5A	8115	7252	FR5-1
7583	7052	YR5	7923	4268	GR45	8116	4998	PLZTR5A-13
7584	7240	YR55	7925	4435	ZFR5E-11	8117	7862	PZTR5A-15
7585	6630	UR4	7926	4043	ZFR4F-11	8118	2763	GR4GP
7586	6630	UR4	7927	7938	BKR5E	8118	3142	GR45GP
7587	6945	UR45	7928	4644	BKR7E	8119	3784	PTR5D-10
7588	6945	UR45	7931	6422	BPR7HS	8120	3716	TR5-1GP
7589	3754	TR4	7950	2438	WR5	8120	7159	TR55-1GP
7590	7060	TR5-1	7951	2438	WR5	8121	5118	PLZKAR6A-11
7591	1034	BP7ES	7952	4652	WR4-1	8122	7654	PLFR6A-11
7591	5534	BPR7ES	7953	2756	BKR6E-11	8123	7781	ZFR5LP-13G
7592	5534	BPR7ES	7955	6962	BKR6E	8161	4997	PLZTR4A-13
7593	7022	BPR6HS	7956	2756	BKR6E-11	8162	92145	LZFR5CI-11
7593	7331	BP6HS	7957	6953	BKR5E-11	8171	90117	ILTR6E11
7594	7131	BPR6ES	7958	3686	FR45	9600	5464	BKR5EIX-11
7594	7333	BP6ES	7959	7558	ZFR5F	9600	7994	IFR5E11
7595	2851	GR5	7961	3459	ZFR5N	9601	5599	ITR4A15
7595	7131	BPR6ES	7962	2262	ZFR5F-11	9601	7164	TR55IX
7596	7534	B6HS	7963	5424	BKR4E-11	9602	1465	IZTR5B11
7597	7022	BPR6HS	7966	3623	BPR6EFS	9602	7397	TR5IX

NOTE: Cross references are provided as a GUIDE ONLY. Due to differences in design / materials, products produced by various mfrs may have different specifications. Please refer to specific application guide for proper usage.

418 NOTA: El cruce de referencias servirá únicamente como guía. Las diferencias en diseño, materiales y los productos utilizados para su elaboración pueden variar dependiendo del fabricante. Para obtener la aplicación correcta de su vehículo, por favor referirse a la sección correspondiente dentro de esta guía.



Competitor #	NGK Stock #	NGK Part #	Competitor #	NGK Stock #	NGK Part #	Competitor #	NGK Stock #	NGK Part #
Bosch			Bosch			Bosch		
9603	6441	ZFR6FIX-11	79015	6987	ZFR6F-11G	D8AC	2438	WR5
9603	6741	IFR6E11	79026	3922	BR6HS	D8B	2438	WR5
9604	3657	IZFR5K11	79027	4983	DCPR7E-N-10	D8BC	2438	WR5
9604	6441	ZFR6FIX-11	80005	6929	Y-810	D9B	2438	WR5
9604	6741	IFR6E11	80006	1250	Y-208T	D9BC	2438	WR5
9605	90813	TR5AI-13	80006	6929	Y-810	D10B	2438	WR5
9605	97287	ITR5H13	80010	1239	Y-207T	D10BC	2438	WR5
9606	90813	TR5AI-13	80014	2930	Y-117RS	DR6BC	2438	WR5
9606	97287	ITR5H13	80015	1229	Y-107R	DR7BC	2438	WR5
9607	3764	BKR6EIX-11	80017	3829	Y-204TS1	DR7BP	7510	WR5IX
9607	6741	IFR6E11	80017	4573	Y-204RS	DR8B	2438	WR5
9608	3689	TR6IX	80018	7492	Y-146R	DR8BC	2438	WR5
9608	90813	TR5AI-13	80019	2187	Y-118R	DR8BC+	2438	WR5
9608	97287	ITR5H13	80020	1229	Y-107R	DR8BPX	7510	WR5IX
9609	1637	ILFR5B11	96300	96779	ILFR5T11	DR8BPX+	7510	WR5IX
9609	4469	LFR5AIX-11	96301	96329	ILTR5L11	DR9B	2438	WR5
9610	3764	BKR6EIX-11	96302	90607	ILTR5K13	DR9BC	2438	WR5
9611	4344	LTR5IX-11	96306	91039	IFR7X7G	DR9BPX	7510	WR5IX
9612	7300	TR4IX	96309	92491	DILFR6J11	DR9BPX+	7510	WR5IX
9613	6619	LFR6AIX-11	96310	96964	DILKAR7H11GS	DR10B	2438	WR5
9614	6774	IZFR6K13	96315	94489	ILTR6M9G	DR10BC	2438	WR5
9614	7746	IFR7G-11KS	96322	5507	PZNR6A11H	DR10BC+	2438	WR5
9615	6240	PLFR5A-11	241229588	7734	BPR6ES	DR10GCO	4652	WR4-1
9615	6619	LFR6AIX-11	241229612	3722	BR5HS	DR10GC+	4652	WR4-1
9615	93759	DILFR5A11	241229617	2238	TR5	DR10GCO	4652	WR4-1
9615	98376	DILFR5A-11D	241235602	7131	BPR6ES	F01G09P2A5	97928	Y1037J
9616	90117	ILTR6E11	242235537	7131	BPR6ES	F03DAR	2288	BKR6EK
9617	6509	LTR6IX-11	242240530	6962	BKR6E	F5DP	5690	BCPR7EIX
9619	5787	ILZKR7B-11S	250001016	3473	Y-924J	F5DP0R	4853	PFR7B
9620	5118	PLZKAR6A-11	250200055	6929	Y-810	F5DPOR	4853	PFR7B
9620	6240	PLFR5A-11	250201032	3704	Y-918J	F5DTC	4563	BCP6ET
9620	9029	DILKAR6A11	250201035	5568	Y-930U	F6DC0R	6962	BKR6E
9621	4912	ILKAR7B11	250201036	5909	Y-732J	F6DCO	3735	BCPR6E
9622	98376	DILFR5A-11D	250201039	3473	Y-924J	F6DCOR	6962	BKR6E
9651	2477	ZFR5FIX-11	250201044	3473	Y-924J	F6DP	5689	BCPR6EIX
9652	5464	BKR5EIX-11	250201054	5740	Y-925J	F6DP+	7092	BKR6EGP
9653	7164	TR55IX	250201055	3704	Y-918J	F6DPOR	6458	PFR6Q
9654	2313	LZTR4AIX-11	250202005	2930	Y-117RS	F6DSR	6418	BKR6EIX
9655	7164	TR55IX	250202007	1229	Y-107R	F6DTC	4563	BCP6ET
9656	3459	ZFR5N	250202008	6244	Y-306R	F6DTC1	2687	FR6E1
9656	7781	ZFR5LP-13G	250202022	5909	Y-732J	F6KPP332S	6458	PFR6Q
9657	7397	TR5IX	250202023	9810	CZ104	F6LTCR	5496	BKUR7ET
9659	7559	UR45IX	250202051	7492	Y-146R	F6MPP332	2309	LFR7AIX
9660	7243	TR5-1IX	250202054	2187	Y-118R	F7DC	7373	FR5
9660	7316	TR55-1IX	250202058	7493	Y-147T	F7DC0	6962	BKR6E
9661	2314	LZTR5AIX-13	250202073	7492	Y-146R	F7DC0R	6962	BKR6E
9664	4997	PLZTR4A-13	250202089	1229	Y-107R	F7DCOR	6962	BKR6E
9664	6441	ZFR6FIX-11	250202097	7493	Y-147T	F7DCR4	5689	BCPR6EIX
9667	2314	LZTR5AIX-13	250202127	97928	Y1037J	F7DCX	2756	BKR6E-11
9673	92145	LZFR5CI-11	250202134	97788	Y1032AS	F7DPER	5555	PFR6G-11
9683	94124	ILKAR7L11	250202142	4705	Y-745U	F7DPP222T	4793	PFR6G
9686	9723	SILZKR7B11	250203010	97788	Y1032AS	F7DPP332	6458	PFR6Q
9691	1989	ILKR7B8	250203011	90046	Y1033AS	F7DTC	4563	BCP6ET
9693	1406	DILKAR7B11	250203017	97788	Y1032AS	F7HPP222	7968	PZFR5D-11
9694	93482	SILZKAR7B11	250212007	97190	Y4002J	F7HPPRX	7968	PZFR5D-11
9697	97177	LTR6CI-8	250212008	5616	Y-408JS	F7KTCR	5509	BCPR7ET
9698	91039	IFR7X7G	250212014	6600	Y-543J	F7LCOR2	4291	ZFR6F-11
9710	95770	ILZKBR7B8DG	242240530000	6962	BKR6E	F7LCOR2	4291	ZFR6F-11
9723	5476	ILTR5D	0242245570000	2309	LFR7AIX	F7LCOT2	4291	ZFR6F-11
9731	97177	LTR6CI-8	D6B	2438	WR5	F7LCR	4291	ZFR6F-11
9745	3656	LZFR6AI	D6BC	2438	WR5	F7LDCR	2288	BKR6EK
9746	96779	ILFR5T11	D7B	2438	WR5	F7LTCR	2397	BKUR6ET-10
9752	9723	SILZKR7B11	D7BC	2438	WR5	F8DC	5155	FR4
9756	96588	LTR6DI-8	D8A	2438	WR5	F8DPER	6341	BKR5EIX

**NOTE:** Cross references are provided as a GUIDE ONLY. Due to differences in design / materials, products produced by various mfrs may have different specifications. Please refer to specific application guide for proper usage.

**REMARQUE:** Les références sont fournies en GUIDE UNIQUEMENT. En raison des différences de conception et de matériaux, des produits fabriqués par différents fabricants peuvent avoir des spécifications différentes. Veuillez vous référer au guide d'application spécifique pour l'utilisation correcte.





# Interchanges / Références

THE IGNITION SPECIALIST

Competitor #	NGK Stock #	NGK Part #	Competitor #	NGK Stock #	NGK Part #	Competitor #	NGK Stock #	NGK Part #
Bosch			Bosch			Bosch		
F8DPP33	4696	IFR5D10	FR6KPP33	7963	PFR7Q	FR7LDC+	4959	BKR6EKC
F8DPP332	4292	PFR5R-11	FR6KPP33+	4014	PFR6B-11	FR7LII33X	3657	IZFR5K11
F8KTCR	1266	BCPR5EY	FR6KPP33X	5542	PFR6T-10G	FR7LII33X	6441	ZFR6FIX-11
F8LCR	7558	ZFR5F	FR6KPP33X+	5542	PFR6T-10G	FR7LII33X	6741	IFR6E11
F8LCR2	7558	ZFR5F	FR6KPP332	4014	PFR6B-11	FR7LPP30X	7100	ZFR6FGP
F8LDCR	2288	BKR6EK	FR6KPP332S	1675	PFR7S8EG	FR7ME	3672	LFR6A-11
F9DCO	6130	BCPR5ES	FR6KTC	5509	BCPR7ET	FR7MPP10	7654	PLFR6A-11
F9LCR	7558	ZFR5F	FR6LDC	2288	BKR6EK	FR7MPP33X	7654	PLFR6A-11
FGR5KQE0	6855	ZFR7F-11	FR6LII330X	6774	IZFR6K13	FR7N1133X	6619	LFR6AIX-11
FGR5NQE0	2309	LFR7AIX	FR6LII330X	7746	IFR7G-11KS	FR7NI33	6481	ILFR6B
FGR5NQE04	2309	LFR7AIX	FR6LPP300X	6994	IZFR6K11	FR7NII35U	6240	PLFR5A-11
FGR6KQC	3199	BKR6EQUP	FR6LPP300X	7772	PFR7G-11S	FR7NII35U	93759	DILFR5A11
FGR6KQE	6855	ZFR7F-11	FR6MPP332	2309	LFR7AIX	FR7NII35U	98376	DILFR5A-11D
FGR6NQE0	2309	LFR7AIX	FR7DC	6962	BKR6E	FR7NPP30X	1483	LFR6CGP
FGR7DQE0	5767	BKR6EQUA	FR7DC	7373	FR5	FR7NPP30X	4904	ILFR6T11
FGR7DQE+	7092	BKR6EGP	FR7DC4	6962	BKR6E	FR7NPP332	4904	ILFR6T11
FGR7DQI	3199	BKR6EQUP	FR7DC+	6962	BKR6E	FR8DC	5155	FR4
FGR7DQP	3199	BKR6EQUP	FR7DCX	2756	BKR6E-11	FR8DC	7938	BKR5E
FGR7KQE	3696	BKR6EY	FR7DCX+	2756	BKR6E-11	FR8DC+	7938	BKR5E
FGR7KQE0	3696	BKR6EY	FR7DE	6364	BKR6ES	FR8DCX	5155	FR4
FGR8DDP	2890	BKR5EKUP	FR7DE2	7969	BKR6EKUB	FR8DCX	6953	BKR5E-11
FGR8DQI	7658	IFR6J11	FR7DII33X	3764	BKR6EIX-11	FR8DCX+	6953	BKR5E-11
FGR8DQP	3199	BKR6EQUP	FR7DII33X	6741	IFR6E11	FR8DCY	3686	FR45
FGR8KQC	3199	BKR6EQUP	FR7DII35V	94167	DIFR6D13	FR8DCY+	3686	FR45
FGR8KQE	2890	BKR5EKUP	FR7DII35X	1312	DIFR6C11	FR8DE	7938	BKR5E
FGR8KQE0	7969	BKR6EKUB	FR7DP	6418	BKR6EIX	FR8DII33X	5464	BKR5EIX-11
FGR8LQI0	4095	IZFR6F11	FR7DP+	6962	BKR6E	FR8DPP30T	7090	BKR5EGP
FGR8LQP0	7094	ZFR6AGP	FR7DPP	3500	PFR6B	FR8DPP30X	7090	BKR5EGP
FGR8LQP0	7100	ZFR6FGP	FR7DPP10	6418	BKR6EIX	FR8DPP33	4696	IFR5D10
FGR8MDP	5018	LFR5AGP	FR7DPP22U	3546	PFR6N-11	FR8DPP33+	4292	PFR5R-11
FGR8MQP	5018	LFR5AGP	FR7DPP30T	7090	BKR5EGP	FR8DPX	5464	BKR5EIX-11
FGR8DDP	2890	BKR5EKUP	FR7DPP30T	7092	BKR6EGP	FR8DPX	6953	BKR5E-11
FGR9DQI	7418	IFR5J11	FR7DPP30X	7092	BKR6EGP	FR8DPX	7090	BKR5EGP
FGR9DQP	3199	BKR6EQUP	FR7DPP33	6458	PFR6Q	FR8DPX+	5464	BKR5EIX-11
FLR8LDCU	2288	BKR6EK	FR7DPP33X	2978	BKR6EP-11	FR8DPX+	6953	BKR5E-11
FLR8LDCU+	2288	BKR6EK	FR7DPP+	3500	PFR6B	FR8DPX+	7090	BKR5EGP
FLR9LTE	7797	BKR5EK	FR7DPX	3764	BKR6EIX-11	FR8DS	6341	BKR5EIX
QFR8DE	4293	BKR6EZB	FR7DPX+	2756	BKR6E-11	FR8DX	5155	FR4
FQR8LEU2	7558	ZFR5F	FR7DQP	3199	BKR6EQUP	FR8DX	6953	BKR5E-11
FR5DC	4644	BKR7E	FR7DTC	5509	BCPR7ET	FR8HCOX	4435	ZFR5E-11
FR5DC+	4644	BKR7E	FR7HC	4435	ZFR5E-11	FR8HCOX	4435	ZFR5E-11
FR5DCX	5791	BKR7E-11	FR7HE2	7797	BKR5EK	FR8HCX+	4435	ZFR5E-11
FR5DP	4644	BKR7E	FR7HE02	4435	ZFR5E-11	FR8HP	4363	PZFR5F-11
FR5DTC	5509	BCPR7ET	FR7HPP22	7968	PZFR5D-11	FR8HPO	4435	ZFR5E-11
FR5KPP332S	1675	PFR7S8EG	FR7HPP33	3586	PZFR6J-11	FR8HPO+	4435	ZFR5E-11
FR5LDC	2095	BKR7EKC-N	FR7HPP33+	7968	PZFR5D-11	FR8HPO	4435	ZFR5E-11
FR6D133	7658	IFR6J11	FR7HPP222	7968	PZFR5D-11	FR8HPP30X	7098	ZFR5FGP
FR6DC	6962	BKR6E	FR7KCU	7990	BKR6EYA	FR8KII33X	5464	BKR5EIX-11
FR6DCP	6418	BKR6EIX	FR7KDC	4959	BKR6EKC	FR8KII33X	7994	IFR5E11
FR6DCX	2756	BKR6E-11	FR7KI332S	5648	IFR6G-G	FR8KII332X	4997	PLZTR4A-13
FR6DCX	7373	FR5	FR7KII33X	6441	ZFR6FIX-11	FR8KII332X	6441	ZFR6FIX-11
FR6DCX+	2756	BKR6E-11	FR7KII33X	6741	IFR6E11	FR8KTC	3735	BCPR6E
FR6DDC	2095	BKR7EKC-N	FR7KPP30X	7092	BKR6EGP	FR8LC	7558	ZFR5F
FR6DP	6418	BKR6EIX	FR7KPP33	4115	PFR6G-13	FR8LC+	7558	ZFR5F
FR6DPP22	4045	PFR6A-11	FR7KPP33+	6458	PFR6Q	FR8LCX	1041	ZFR6A-11
FR6DPP22U	3546	PFR6N-11	FR7KPP33U	6290	PFR6H-10	FR8LCX+	2262	ZFR5F-11
FR6DPP332	6458	PFR6Q	FR7KPP33U+	7092	BKR6EGP	FR8LD+U	7797	BKR5EK
FR6DPP332S	6458	PFR6Q	FR7KPP332	4294	IZFR6H11	FR8LDC	7797	BKR5EK
FR6DPX	3764	BKR6EIX-11	FR7KPP332U	5757	PFR6X-11	FR8LDC4	7797	BKR5EK
FR6DTC	5509	BCPR7ET	FR7KTC	3735	BCPR6E	FR8LII33X	2477	ZFR5FIX-11
FR6K1133X	3764	BKR6EIX-11	FR7LDC	2288	BKR6E	FR8LPP30X	7098	ZFR5FGP
FR6KDC	4959	BKR6EKC	FR7LDC	2288	BKR6E	FR8LPP33X	4363	PZFR5F-11
FR6KDE0	4959	BKR6EKC	FR7LDC	2288	BKR6E	FR8LPP302X	7098	ZFR5FGP
FR6KI332S	4867	IFR6B-K	FR7LDC4	2288	BKR6E	FR8LPX	4363	PZFR5F-11

NOTE: Cross references are provided as a GUIDE ONLY. Due to differences in design / materials, products produced by various mfrs may have different specifications. Please refer to specific application guide for proper usage.

420 NOTA: El cruce de referencias servirá únicamente como guía. Las diferencias en diseño, materiales y los productos utilizados para su elaboración pueden variar dependiendo del fabricante. Para obtener la aplicación correcta de su vehículo, por favor referirse a la sección correspondiente dentro de esta guía.





Competitor #	NGK Stock #	NGK Part #	Competitor #	NGK Stock #	NGK Part #	Competitor #	NGK Stock #	NGK Part #
Bosch			Bosch			Bosch		
FR8LPX+	4363	PZFR5F-11	HGR7KQC	5141	TR6GP	HR7MPP+	2467	PTR5A-13
FR8ME	6376	LFR5A-11	HGR7MDP0	3587	PLTR6A-10G	HR7NII33X	90117	ILTR6E11
FR8MII33X	4469	LFR5AIX-11	HGR7MQI0	3787	ILTR6A-8G	HR8A	7052	YR5
FR8MII33X	1637	ILFR5B11	HGR7MQP0	3587	PLTR6A-10G	HR8AC	7052	YR5
FR8MPP30X	5018	LFR5AGP	HGR8BDP	3547	UR5GP	HR8AC+	7052	YR5
FR8NII35U	98376	DILFR5A-11D	HGR8BQI	7348	UR6IX	HR8ACY	7240	YR55
FR8SII33X	92145	LZFR5CI-11	HGR8BQP	7966	UR6GP	HR8AY	7240	YR55
FR8SPP30X	92145	LZFR5CI-11	HGR8DDP	3784	PTR5D-10	HR8B	6630	UR4
FR8SPP30X	97606	PLZFR5B13EG	HGR8DQI	4477	ITR6F13	HR8BC	6630	UR4
FR8TE2	92174	LZFR5C-11	HGR8DQP	3186	TR5GP	HR8BC+	2771	UR5
FR8TI332	97606	PLZFR5B13EG	HGR8MDP	2467	PTR5A-13	HR8BCY	7272	UR55IX
FR8VII33U	3459	ZFR5N	HGR8MDP0	90083	LTR5BI-13	HR8BP	7401	UR4IX
FR8VII33U	7781	ZFR5LP-13G	HGR8MDP0	90607	ILTR5K13	HR8BP+	2771	UR5
FR8VPP30U	7096	ZFR5EGP	HGR8MQI	5581	ILTR5C11	HR8BPX	7401	UR4IX
FR8VPP33U	7252	FR5-1	HGR8MQI0	5581	ILTR5C11	HR8BPX+	2771	UR5
FR8VPP332V	7781	ZFR5LP-13G	HGR8MQP	2467	PTR5A-13	HR8BPY	2248	UR55
FR9DC	4421	BKR4E	HGR8MQP0	2467	PTR5A-13	HR8BY	6630	UR4
FR9DCX	5424	BKR4E-11	HGR9BDP	3547	UR5GP	HR8D1133X	7397	TR5IX
FR9DPV	5464	BKR5EIX-11	HGR9BQI	7177	UR5IX	HR8DC	2238	TR5
FR9HC	4043	ZFR4F-11	HGR9BQP	3547	UR5GP	HR8DC+	2238	TR5
FR9HC+	3459	ZFR5N	HGR9DDP	3784	PTR5D-10	HR8DCV	2238	TR5
FR9HCV	5084	ZFR5A-11	HGR9DQI	97287	ITR5H13	HR8DCX	2238	TR5
FR9HP	3459	ZFR5N	HGR9DQP	3186	TR5GP	HR8DCX+	2238	TR5
FR9HP+	3459	ZFR5N	HGR9LDP0	3186	TR5GP	HR8DPP30V	3403	TR55GP
FR9HPV	7743	PZFR5J-11	HGR9LQI0	1465	IZTR5B11	HR8DPP30X	3186	TR5GP
FR9LCX	4043	ZFR4F-11	HGR9LQP0	7862	PZTR5A-15	HR8DPP30Y	3403	TR55GP
FR9LCX+	4043	ZFR4F-11	HR5DC	3690	TR7IX	HR8DPP33V	93858	TR5BP12
FR10DC	5424	BKR4E-11	HR6B	2771	UR5	HR8DPP33X	3784	PTR5D-10
FR10DCX	5424	BKR4E-11	HR6BC	2771	UR5	HR8DPX	7397	TR5IX
FR10DCX+	5424	BKR4E-11	HR6D	3623	BPR6EFS	HR8DPX+	3186	TR5GP
FR10DX	5424	BKR4E-11	HR6D	4177	TR6	HR8HC0	7060	TR5-1
FRDCX	7373	FR5	HR6DC	3623	BPR6EFS	HR8JII33V	7243	TR5-1IX
FRHPV	7098	ZFR5FGP	HR6DC	4177	TR6	HR8JII33V	7316	TR55-1IX
H6B	2771	UR5	HR6DC+	3623	BPR6EFS	HR8JPP33V	3716	TR5-1GP
H6BC	2771	UR5	HR6DP	3623	BPR6EFS	HR8JPP302V	7159	TR55-1GP
H6D	2238	TR5	HR6DP+	3623	BPR6EFS	HR8KII33V	7164	TR55IX
H6DC	2238	TR5	HR6DPP33X	7740	PTR5C-13	HR8KII33Y	7164	TR55IX
H6DC0	3623	BPR6EFS	HR6DS	2238	TR5	HR8LCO	7060	TR5-1
H6DP	3623	BPR6EFS	HR6DS	3623	BPR6EFS	HR8LCO	7060	TR5-1
H7D	2238	TR5	HR6DS	4177	TR6	HR8LII33U	7397	TR5IX
H7DC	3623	BPR6EFS	HR6KII33X	3689	TR6IX	HR8LII33U	1465	IZTR5B11
H7DC0	3623	BPR6EFS	HR6KII33X	90813	TR5AI-13	HR8LP0	7243	TR5-1IX
H7DCY	3951	TR55	HR6KII33X	97287	ITR5H13	HR8LPO	3716	TR5-1GP
H7DP	3623	BPR6EFS	HR7BPP30X	7966	UR6GP	HR8LPP30U	3186	TR5GP
H7LDCR	3689	TR6IX	HR7DC	3623	BPR6EFS	HR8LPP33U	3784	PTR5D-10
H8B	6630	UR4	HR7DC	4177	TR6	HR8LPX	7243	TR5-1IX
H8BC	6630	UR4	HR7DC+	3623	BPR6EFS	HR8LPX+	3716	TR5-1GP
H8BP	7177	UR5IX	HR7DII33V	97287	ITR5H13	HR8MII33X	4344	LTR5IX-11
H8DC	2238	TR5	HR7DII33V	90813	TR5AI-13	HR8MPP30X	5019	LTR5GP
H8DC0	2238	TR5	HR7DPP30V	5141	TR6GP	HR8MPP33X	2467	PTR5A-13
H8DCO	2238	TR5	HR7DPP30Y	3403	TR55GP	HR8NPP302	90117	ILTR6E11
H8DCX	2238	TR5	HR7DPP30Y	5141	TR6GP	HR8NPP302X	5019	LTR5GP
H8DP	7397	TR5IX	HR7DPP33V	7740	PTR5C-13	HR8SII330V	2314	LZTR5AIX-13
H9B	6630	UR4	HR7DPP33Y	7740	PTR5C-13	HR8SPP300V	4998	PLZTR5A-13
H9BC	6630	UR4	HR7KII33V	97287	ITR5H13	HR8TII3302V	2314	LZTR5AIX-13
H9BCY	6945	UR45	HR7KII33V	90813	TR5AI-13	HR8TPP3002V	3381	LZTR5AGP
H9DC	2238	TR5	HR7MPP	2467	PTR5A-13	HR8TPP3002V	4998	PLZTR5A-13
H9DC0	2238	TR5	HR7MPP22U	3587	PLTR6A-10G	HR8TPP3302V	4998	PLZTR5A-13
H9DCO	2238	TR5	HR7MPP22V	2467	PTR5A-13	HR9A	7052	YR5
H10B	6630	UR4	HR7MPP30X	5019	LTR5GP	HR9AC	7052	YR5
H10BC	6630	UR4	HR7MPP30X	6509	LTR6IX-11	HR9AC+	7052	YR5
HGR6KQC	3690	TR7IX	HR7MPP33X	2467	PTR5A-13	HR9ACY	7240	YR55
HGR7DQP	3186	TR5GP	HR7MPP302	3587	PLTR6A-10G	HR9ACY+	7240	YR55
HGR7DQP	5141	TR6GP	HR7MPP302X	3587	PLTR6A-10G	HR9APX	7516	YR5IX

**NOTE:** Cross references are provided as a GUIDE ONLY. Due to differences in design / materials, products produced by various mfrs may have different specifications. Please refer to specific application guide for proper usage.

**REMARQUE:** Les références sont fournies en GUIDE UNIQUEMENT. En raison des différences de conception et de matériaux, des produits fabriqués par différents fabricants peuvent avoir des spécifications différentes. Veuillez vous référer au guide d'application spécifique pour l'utilisation correcte.



Competitor #			Competitor #			Competitor #		
NGK Stock #	NGK Part #		NGK Stock #	NGK Part #		NGK Stock #	NGK Part #	
Bosch			Bosch			Bosch		
HR9APX+	2953	YR5GP	HR10BCX+	6630	UR4	W4A1	5510	B8HS
HR9AY	7240	YR55	HR10BCY	6945	UR45	W4A2	5510	B8HS
HR9B	6630	UR4	HR10BCY+	6945	UR45	W4A5	5510	B8HS
HR9BC	6630	UR4	HR10BCZ	6945	UR45	W4AC	5510	B8HS
HR9BC+	6630	UR4	HR10BCZ+	6945	UR45	W4AP	7001	BR8HIX
HR9BCX	3207	UR45GP	HR10BX	6630	UR4	W4AS	7001	BR8HIX
HR9BCY	6945	UR45	HR10BY	6945	UR45	W4C	2411	B8ES
HR9BCY+	6945	UR45	HR10DCX	3754	TR4	W4C1	2411	B8ES
HR9BCZ	6945	UR45	HR10DCX+	3754	TR4	W4C2	1111	B7ES
HR9BII33V	7559	UR45IX	HR10HC0	7060	TR5-1	W4C3	5110	B7HS
HR9BP	7401	UR4IX	HR10HC+	7060	TR5-1	W4CC	2411	B8ES
HR9BP+	2869	UR4GP	HR10HC0	7060	TR5-1	W4CP	5044	BR8EIX
HR9BPP30V	3207	UR45GP	HRBFX	2869	UR4GP	W4CS	5044	BR8EIX
HR9BPP30X	2869	UR4GP	HRDC	2238	TR5	W4DP	4055	BPR7EIX
HR9BPX	7401	UR4IX	M4A	3010	AB-7	W4DP0	5509	BCPR7ET
HR9BPX+	2869	UR4GP	M4A1	7909	AB-8	W5A	5110	B7HS
HR9BPY	7559	UR45IX	M4A2	3010	AB-7	W5AC	5110	B7HS
HR9BPY+	3207	UR45GP	M4AC	3010	AB-7	W5AP	7067	BR7HIX
HR9BPZ	7559	UR45IX	M5A	3010	AB-7	W5AS	7067	BR7HIX
HR9BPZ+	3207	UR45GP	M5AC	3010	AB-7	W5B	5111	BP7HS
HR9BY	6945	UR45	M7AC	3010	AB-7	W5BC	5111	BP7HS
HR9D	2238	TR5	M8AC	2910	AB-6	W5BP	5944	BPR7HIX
HR9DC	2238	TR5	M8AC0	2910	AB-6	W5C	1111	B7ES
HR9DC+	2238	TR5	M8ACO	2910	AB-6	W5CP	6664	BR7EIX
HR9DCX	2238	TR5	M10AC	2910	AB-6	W5CS	6664	BR7EIX
HR9DCX+	3951	TR55	M10AC0	2910	AB-6	W5D	1034	BP7ES
HR9DCY	3951	TR55	M10AC0	2910	AB-6	W5D1	1034	BP7ES
HR9DCY+	3951	TR55	M12B	2438	WR5	W5DC	1034	BP7ES
HR9DI33Y	97287	ITR5H13	UEC	4216	R0045Q-10	W5DC0	1034	BP7ES
HR9DPP30Y	2815	TR4GP	UR2AS	2086	CR8HSA	W5DCO	5534	BPR7ES
HR9DPX	7300	TR4IX	UR2CC	1275	CR8E	W5DCX	7226	BPR7ES-11
HR9DPX+	7397	TR5IX	UR3AS	7223	CR7HS	W5DP	4055	BPR7EIX
HR9DPY	7164	TR55IX	UR3CC	4578	CR7E	W5DP0	5509	BCPR7ET
HR9DPY+	7164	TR55IX	UR4AS	7023	CR6HS	W5DPX	4055	BPR7EIX
HR9HC0	7060	TR5-1	UR6DE	4455	CR7EKB	W5DTC	1263	BP6ET
HR9HC+	7060	TR5-1	UR09CC	1275	CR8E	W6AS	3419	BR6HIX
HR9HCO	7060	TR5-1	VR7NII33X	4912	ILKAR7B11	W6B	7331	BP6HS
HR9HPO	7316	TR55-1IX	VR8NII35U	5118	PLZKAR6A-11	W6BC	7331	BP6HS
HR9HPO+	7159	TR55-1GP	VR8NII35U	6240	PLFR5A-11	W6BP	4085	BPR6HIX
HR9HPO	7159	TR55-1GP	VR8NII35U	9029	DILKAR6A11	W6CS	6801	BR10EIX
HR9KII33Y	7164	TR55IX	VR8SPP33X	5118	PLZKAR6A-11	W6D1	7333	BP6ES
HR9KII33Y	5599	ITR4A15	W2A	5810	B9HS	W6DC	7333	BP6ES
HR9L1133X	7300	TR4IX	W2AC	5810	B9HS	W6DC0	7333	BP6ES
HR9LCX	7060	TR5-1	W2AS	5687	BR9HIX	W6DP	6637	BPR6EIX
HR9LCX+	7060	TR5-1	W2C	7928	B10ES	W6DP0	6637	BPR6EIX
HR9LCY	2683	TR55-1	W2C0	7928	B10ES	W6DPO	7084	BPR6EGP
HR9LCY+	2683	TR55-1	W2CC	7928	B10ES	W6DTC	1263	BP6ET
HR9LI33U	1465	IZTR5B11	W2CS	6801	BR10EIX	W6LTCR	7517	BUR6ET
HR9LPP30X	2815	TR4GP	W3A	5510	B8HS	W7A	7534	B6HS
HR9LPP33X	7862	PZTR5A-15	W3A0	5510	B8HS	W7A0	7534	B6HS
HR9LPX	7243	TR5-1IX	W3AC	5510	B8HS	W7AC	7534	B6HS
HR9LPX+	3716	TR5-1GP	W3AO	5510	B8HS	W7AO	7534	B6HS
HR9SII330X	2313	LZTR4AIX-11	W3AP	7001	BR8HIX	W7AP	3419	BR6HIX
HR9SPP300X	3381	LZTR5AGP	W3AS	7001	BR8HIX	W7AS	6692	BR10HIX
HR9SPP300X	5017	LZTR4AGP	W3C	2611	B9ES	W7B	7331	BP6HS
HR10A	7052	YR5	W3C0	2611	B9ES	W7BC	7331	BP6HS
HR10AC	7052	YR5	W3CC	2611	B9ES	W7BP	4085	BPR6HIX
HR10AC+	7052	YR5	W3CP	3981	BR9EIX	W7C	7432	B6ES
HR10ACY	7240	YR55	W3CS	3981	BR9EIX	W7CC	7432	B6ES
HR10AY	7240	YR55	W3D	2912	BP8ES	W7CC0	7432	B6ES
HR10B	6630	UR4	W3DP	2912	BP8ES	W7CCO	4922	BR6ES
HR10BC	6630	UR4	W3DP0	2912	BP8ES	W7CP	7432	B6ES
HR10BC+	6630	UR4	W3DP2	2912	BP8ES	W7D	7333	BP6ES
HR10BCX	6630	UR4	W4A	5510	B8HS	W7D0	7333	BP6ES

NOTE: Cross references are provided as a GUIDE ONLY. Due to differences in design / materials, products produced by various mfrs may have different specifications. Please refer to specific application guide for proper usage.



Competitor #	NGK Stock #	NGK Part #	Competitor #	NGK Stock #	NGK Part #	Competitor #	NGK Stock #	NGK Part #
Bosch			Bosch			Bosch		
W7DC	7333	BP6ES	WR3CP	3981	BR9EIX	WR8BC	6222	BPR5HS
W7DC0	7333	BP6ES	WR3CS	3981	BR9EIX	WR8BC+	6222	BPR5HS
W7DCR	2851	GR5	WR3CTC	6612	BR8ET	WR8C	5866	BR5ES
W7DO	7333	BP6ES	WR4AC	4322	BR8HS	WR8CC	5866	BR5ES
W7DP	6637	BPR6EIX	WR4CC	5422	BR8ES	WR8CC+	5866	BR5ES
W7DSR	7131	BPR6ES	WR4CP	5044	BR8EIX	WR8CP	5866	BR5ES
W7DTC	1263	BP6ET	WR4DP0	5534	BPR7ES	WR8CP+	5866	BR5ES
W7LTCR	7517	BUR6ET	WR5A	4122	BR7HS	WR8D	2635	GR4
W8A	4210	B5HS	WR5AC	4122	BR7HS	WR8D	7734	BPR5ES
W8A0	4210	B5HS	WR5AP	4122	BR7HS	WR8DC	2635	GR4
W8AC	4210	B5HS	WR5BC+	6422	BPR7HS	WR8DC	7131	BPR6ES
W8AO	3722	BR5HS	WR5CC	5122	BR7ES	WR8DC	7734	BPR5ES
W8AP	4210	B5HS	WR5D	5534	BPR7ES	WR8DC4	7734	BPR5ES
W8AP+	3722	BR5HS	WR5DC	5534	BPR7ES	WR8DC+	4006	BPR5ES SOLID
W08AS	5687	BR9HIX	WR5DC+	5534	BPR7ES	WR8DCW	7634	BPR5ES-11
W8B	4111	BP5HS	WR5DP	3785	BPR7ES SOLID	WR8DCX	2635	GR4
W8BC	4111	BP5HS	WR5DP	5534	BPR7ES	WR8DCX	7634	BPR5ES-11
W8C	6410	B5ES	WR5DP+	5534	BPR7ES	WR8DCX+	7634	BPR5ES-11
W8C0	6410	B5ES	WR5DS	4055	BPR7EIX	WR8DP	6597	BPR5EIX
W8CC	6410	B5ES	WR6BC	7022	BPR6HS	WR8DP+	7734	BPR5ES
W8CO	5866	BR5ES	WR6BC+	7022	BPR6HS	WR8DPX	2115	BPR5EIX-11
W8D	7832	BP5ES	WR6D	2851	GR5	WR8DPX+	7634	BPR5ES-11
W8DC	7832	BP5ES	WR6DC	2851	GR5	WR8DPY	4268	GR45
W8DC0	7832	BP5ES	WR6DC+	7131	BPR6ES	WR8DS	6597	BPR5EIX
W8DCO	7832	BP5ES	WR6DCX	2851	GR5	WR8E	3522	BR6S
W8DP	7832	BP5ES	WR6DCX	7133	BPR6ES-11	WR8EC	3332	XR5
W8DTC	1263	BP6ET	WR6DP	6637	BPR6EIX	WR8EC+	3522	BR6S
W8F	2298	R5670-5	WR6DP0	7084	BPR6EGP	WR8F	3332	XR5
W8FC	2298	R5670-5	WR6DP+	7131	BPR6ES	WR8FC	3332	XR5
W8LCR	5077	ZGR5A	WR6DPX	3903	BPR6EIX-11	WR8FP	5858	XR4
W8LDCR	7517	BUR6ET	WR6DS	6637	BPR6EIX	WR8LC	5077	ZGR5A
W8LPR	5077	ZGR5A	WR7A	3922	BR6HS	WR8LC+	5077	ZGR5A
W8LPR+	5077	ZGR5A	WR7AC	3922	BR6HS	WR8LPP30V	3142	GR45GP
W8LTCR	7517	BUR6ET	WR7AC+	7534	B6HS	WR8LPP33X	2763	GR4GP
W9AC	4210	B5HS	WR7B	7022	BPR6HS	WR9A0	3722	BR5HS
W9AC0	4210	B5HS	WR7BC	7022	BPR6HS	WR9A0	3722	BR5HS
W9ACO	3722	BR5HS	WR7BC+	7022	BPR6HS	WR9C	5866	BR5ES
W9D	7832	BP5ES	WR7BP	7022	BPR6HS	WR9CC	5866	BR5ES
W9DC	7832	BP5ES	WR7BP+	7022	BPR6HS	WR9D	2635	GR4
W9DC0	7734	BPR5ES	WR7C	4922	BR6ES	WR9D	7734	BPR5ES
W9DP	6597	BPR5EIX	WR7CC	4922	BR6ES	WR9DC	2635	GR4
W9E	3210	B-4	WR7CC+	4922	BR6ES	WR9DC	7734	BPR5ES
W9EC	3210	B-4	WR7CCX+	4922	BR6ES	WR9DC+	7734	BPR5ES
W9F	2298	R5670-5	WR7CP	4922	BR6ES	WR9DCX	2635	GR4
W9FC	2298	R5670-5	WR7CP+	4922	BR6ES	WR9DCX+	7634	BPR5ES-11
W9HC	6334	ZGR5C	WR7CPX+	4922	BR6ES	WR9DCY	4268	GR45
W9LC	5077	ZGR5A	WR7D	2851	GR5	WR9DCY+	6937	BPR5EY-11
W9LDCR	5685	BPR5EKU	WR7DC	2851	GR5	WR9DP	6597	BPR5EIX
W10E	3210	B-4	WR7DC+	7131	BPR6ES	WR9DP+	7734	BPR5ES
W10EC	3210	B-4	WR7DCX	2851	GR5	WR9DPX	2115	BPR5EIX-11
W10F	5858	XR4	WR7DCX	7133	BPR6ES-11	WR9DPX+	7634	BPR5ES-11
W10FC	7189	XR4IX	WR7DDC4	6637	BPR6EIX	WR9DS	6597	BPR5EIX
W200T35	7131	BPR6ES	WR7DDC4	7131	BPR6ES	WR9DY	4268	GR45
WGR7DDP	6637	BPR6EIX	WR7DP	6637	BPR6EIX	WR9E	3522	BR6S
WGR7DQI	6637	BPR6EIX	WR7DP+	7131	BPR6ES	WR9E0	3522	BR6S
WGR7DQP	7084	BPR6EGP	WR7DPX	3903	BPR6EIX-11	WR9EC	3522	BR6S
WGR8DDP	3573	PGR5A-11	WR7DPX+	7084	BPR6EGP	WR9EC0	3522	BR6S
WGR8DQI	6637	BPR6EIX	WR7DS	6637	BPR6EIX	WR9EC3	3522	BR6S
WGR8DQP	7084	BPR6EGP	WR7EC	3522	BR6S	WR9EC+	3522	BR6S
WGR9DDP	3573	PGR5A-11	WR7F	3332	XR5	WR9EO	3522	BR6S
WGR9DQI	6597	BPR5EIX	WR7LTC+	7517	BUR6ET	WR9FC	5858	XR4
WGR9DQP	7082	BPR5EGP	WR8AC	3722	BR5HS	WR9FC+	5858	XR4
WR2CC	4832	BR10ES	WR8AC+	3722	BR5HS	WR9FCY	4536	XR45
WR3CC	5722	BR9ES	WR8AP	3722	BR5HS	WR9FCZ	4536	XR45

**NOTE:** Cross references are provided as a GUIDE ONLY. Due to differences in design / materials, products produced by various mfrs may have different specifications. Please refer to specific application guide for proper usage.

**REMARQUE:** Les références sont fournies en GUIDE UNIQUEMENT. En raison des différences de conception et de matériaux, des produits fabriqués par différents fabricants peuvent avoir des spécifications différentes. Veuillez vous référer au guide d'application spécifique pour l'utilisation correcte.



Competitor #	NGK Stock #	NGK Part #	Competitor #	NGK Stock #	NGK Part #	Competitor #	NGK Stock #	NGK Part #
<b>Bosch</b>			<b>Briggs &amp; Stratton</b>			<b>Brisk</b>		
WR9FP	7189	XR4IX	692051	7938	BKR5E	N15W	7001	BR8HIX
WR9FP+	5858	XR4	694385	7938	BKR5E	N15Y	7331	BP6HS
WR9FPY	7293	XR45IX	696202	7090	BKR5EGP	N15YC	7331	BP6HS
WR9FPY+	4536	XR45	696798	7938	BKR5E	N17	7534	B6HS
WR9FPZ	4536	XR45	711252	7022	BPR6HS	N17C	7534	B6HS
WR9FPZ+	4536	XR45	793541	7938	BKR5E	N17W	7067	BR7HIX
WR9HC	6334	ZGR5C	797235	4008	BPR6ES SOLID	N17Y	4111	BP5HS
WR9LC	2635	GR4	798615	7333	BP6ES	N17YC	4111	BP5HS
WR9LE	5077	ZGR5A	805015	7938	BKR5E	N19	4210	B5HS
WR9LP	97382	GR4IX	<b>Brisk</b>			N19C	4210	B5HS
WR9LP+	2763	GR4GP	B12YC	6629	DP9EA-9	NR12YC	3725	BPR8HS
WR9LS	5077	ZGR5A	B14YC	5829	DP8EA-9	NR15YC	7022	BPR6HS
WR10E	3522	BR6S	B15YC	5629	DP7EA-9	<b>Champion</b>		
WR10F	5858	XR4	DR12YC	4644	BKR7E	10	2298	R5670-5
WR10FC	5858	XR4	DR14YC	4644	BKR7E	11	2438	WR5
WR10FC+	5858	XR4	DR14ZC	6855	ZFR7F-11	11C2	2438	WR5
WR10FCY	4536	XR45	DR14ZC1	1095	BCPR7ES-11	11S	2438	WR5
WR10FCY+	5858	XR4	DR15YC	6364	BKR6ES	13	3951	TR55
WR10FCZ	4536	XR45	DR15Z	6364	BKR6ES	13C2	3951	TR55
WR10FCZ+	4536	XR45	DR15Z1	5553	BKR6ES-11	13S	3951	TR55
WR10FY	4536	XR45	DR17YC	2460	BKR5ES	14	3332	XR5
WR10LC	2635	GR4	G15Y	3623	BPR6EFS	14C2	3332	XR5
WR10LC+	5077	ZGR5A	G15YC	3623	BPR6EFS	15	3754	TR4
WR10LCV	4268	GR45	GR15YC	3623	BPR6EFS	15C2	3754	TR4
WR10LCV+	4268	GR45	K19	3210	B-4	15S	3754	TR4
WRDCX	2851	GR5	L08W	6801	BR10EIX	17	6945	UR45
WS5F	7321	BPM7A	L10JW	5044	BR8EIX	17C2	6945	UR45
WS7F	7321	BPM7A	L12W	3981	BR9EIX	18	6630	UR4
X3CP0	3437	DR9EA	L12Y	2912	BP8ES	18C2	6630	UR4
X4CS	2120	D8EA	L12YC	2912	BP8ES	18S	6630	UR4
X5DC	5129	DPR7EA-9	L14	2411	B8ES	19	6630	UR4
XR2AS	5123	DR8HS	L14C	2411	B8ES	19C2	6945	UR45
XR2CS	5423	DR8ES	L14Y	1034	BP7ES	20	2238	TR5
XR4AS	5123	DR8HS	L14YC	1034	BP7ES	21	2438	WR5
XR4CS	5423	DR8ES	L15	1111	B7ES	21CC	2438	WR5
XR4DC	4929	DPR8EA-9	L15C	1111	B7ES	21S	2438	WR5
XR5DC	5129	DPR7EA-9	L15W	6664	BR7EIX	22	2438	WR5
XR7LDC	5129	DPR7EA-9	L15Y	7333	BP6ES	22CC	2438	WR5
Y5DDC	6546	DCPR8EIX	L15YC	7333	BP6ES	22S	2438	WR5
Y6DC	4339	DCPR8E	L17	7432	B6ES	25	6630	UR4
YR5DDE	7795	KR9CI	L17C	7432	B6ES	25C2	6630	UR4
YR6DES	4339	DCPR8E	L17W	6664	BR7EIX	25S	6630	UR4
YR6KI332S	91715	IKR7H8	L17Y	7832	BP5ES	31	4268	GR45
YR6LDE	7415	DCPR8EKP	L17YC	7832	BP5ES	31C2	4268	GR45
YR6SI330X	5787	ILZKR7B-11S	L19C	6410	B5ES	31S	4268	GR45
YR7DE	3932	DCPR7E	LR12YC	3923	BPR8ES	35	7240	YR55
YR7LPP332W	3481	DCPR6E	LR12ZC	3923	BPR8ES	37	6945	UR45
YR7MPP33	4288	PLKR7A	LR14TXS	7517	BUR6ET	37C2	6945	UR45
YR7NE	5847	LKR7B-9	LR14YC	5534	BPR7ES	38	7832	BP5ES
YR7SES	1643	LKR7E	LR14ZC	5534	BPR7ES	58	5858	XR4
YR8SEU	1643	LKR7E	LR14ZC1	7226	BPR7ES-11	58CC	5858	XR4
ZQR8SI302	90223	PLZKBR7B8DG	LR15TXS	7517	BUR6ET	58S	5858	XR4
ZR7SI332S	90223	PLZKBR7B8DG	LR15YC	7131	BPR6ES	63	5858	XR4
<b>Briggs &amp; Stratton</b>			LR15Z	7131	BPR6ES	63CC	5858	XR4
5066A	7938	BKR5E	LR15Z1	7133	BPR6ES-11	66	4536	XR45
5066B	7938	BKR5E	LR17YC	7734	BPR5ES	66C2	4536	XR45
491055	7938	BKR5E	N08W	6692	BR10HIX	66S	4536	XR45
491055S	7938	BKR5E	N12W	5687	BR9HIX	71	6719	BKR5E BLYB
496018	7938	BKR5E	N14	5510	B8HS	71	7938	BKR5E
496018S	7938	BKR5E	N14C	5510	B8HS	71-1	7938	BKR5E
496018T	7938	BKR5E	N14Y	5111	BP7HS	71C2	7938	BKR5E
499608	7938	BKR5E	N14YC	5111	BP7HS	71ECO	7938	BKR5E
557039	6263	CR9E	N15	5110	B7HS	71ECOS	7938	BKR5E
691043	6962	BKR6E	N15C	5110	B7HS	71EZ	7938	BKR5E

NOTE: Cross references are provided as a GUIDE ONLY. Due to differences in design / materials, products produced by various mfrs may have different specifications. Please refer to specific application guide for proper usage.

424 NOTA: El cruce de referencias servirá únicamente como guía. Las diferencias en diseño, materiales y los productos utilizados para su elaboración pueden variar dependiendo del fabricante. Para obtener la aplicación correcta de su vehículo, por favor referirse a la sección correspondiente dentro de esta guía.



Competitor #	NGK Stock #	NGK Part #	Competitor #	NGK Stock #	NGK Part #	Competitor #	NGK Stock #	NGK Part #
Champion			Champion			Champion		
71G	7938	BKR5E	322	7634	BPR5ES-11	415ECO	7131	BPR6ES
71GS	7938	BKR5E	322	7734	BPR5ES	415S	7131	BPR6ES
71S	7938	BKR5E	322-1	7634	BPR5ES-11	418	2756	BKR6E-11
79	6945	UR45	322C2	7634	BPR5ES-11	418CC	2756	BKR6E-11
79C2	6945	UR45	322ECO	7634	BPR5ES-11	426	2756	BKR6E-11
79S	6945	UR45	322EZ	7634	BPR5ES-11	430	2756	BKR6E-11
82	7252	FR5-1	322S	7634	BPR5ES-11	430C2	2756	BKR6E-11
82C2	7252	FR5-1	327	7022	BPR6HS	430S	2756	BKR6E-11
89	6953	BKR5E-11	327C	7022	BPR6HS	431	4421	BKR4E
89C2	3686	FR45	328	5111	BP7HS	431	5155	FR4
91	3212	B-6L	328-1	5111	BP7HS	431-1	7938	BKR5E
97	7558	ZFR5F	332	7131	BPR6ES	431C2	7938	BKR5E
101	6334	ZGR5C	332ECO	7131	BPR6ES	431S	4421	BKR4E
102	3522	BR6S	335	2330	BCPR6ES	431S	5155	FR4
104	5122	BR7ES	337	6962	BKR6E	434	2262	ZFR5F-11
105	2264	BPR2ES	339	3785	BPR7ES SOLID	434C2	2262	ZFR5F-11
105	4268	GR45	340	4644	BKR7E	435	2262	ZFR5F-11
105	6770	BPR2ES BLYB	344	6962	BKR6E	436	2262	ZFR5F-11
105C2	4268	GR45	344CC	6962	BKR6E	436	4291	ZFR6F-11
105S	4268	GR45	344S	6962	BKR6E	436C2	4291	ZFR6F-11
108	7240	YR55	345	2756	BKR6E-11	436S	2262	ZFR5F-11
113	7052	YR5	346	2756	BKR6E-11	438	3459	ZFR5N
113C2	7052	YR5	346C2	2756	BKR6E-11	438C2	3459	ZFR5N
120	2411	B8ES	347	6987	ZFR6F-11G	439	2262	ZFR5F-11
123	4922	BR6ES	349	95897	MR7F	439	6987	ZFR6F-11G
129	3323	AR6FS	353	6962	BKR6E	439C2	2262	ZFR5F-11
129S	3323	AR6FS	354	7797	BKR5EK	443	5306	LZTR4A-11
130	4652	WR4-1	400	7773	UR6	443C2	5306	LZTR4A-11
130C2	4652	WR4-1	401	2238	TR5	444	4644	BKR7E
142	5616	Y-408JS	401	3623	BPR6EFS	445	1643	LKR7E
143	90046	Y1033AS	401	3754	TR4	446	92174	LZFR5C-11
149	2187	Y-118R	401C2	3754	TR4	446C2	92174	LZFR5C-11
160	1239	Y-207T	401S	2238	TR5	449	5129	DPY7EA-9
161	3473	Y-924J	401S	3623	BPR6EFS	470	4306	LZTR5A-13
190	97928	Y1037J	401S	3754	TR4	470CC	4306	LZTR5A-13
192	5909	Y-732J	403	7060	TR5-1	471	6953	BKR5E-11
193	4705	Y-745U	403CC	7060	TR5-1	502	2910	AB-6
194	97190	Y4002J	404	7734	BPR5ES	506	7909	AB-8
195	3473	Y-924J	404C2	7734	BPR5ES	509	2910	AB-6
198	3704	Y-918J	404S	7734	BPR5ES	511	3210	B-4
247	6637	BPR6EIX	405	2635	GR4	512	3212	B-6L
248	6637	BPR6EIX	405	6578	BPR4ES SOLID	514	2910	AB-6
279	4644	BKR7E	405	7734	BPR5ES	515	2910	AB-6
284	4644	BKR7E	405	97226	BPR4ES BLYB	516	2910	AB-6
293	6596	R5671A-11	405C2	7734	BPR5ES	523	2910	AB-6
300	7333	BP6ES	405S	7734	BPR5ES	525	6630	UR4
301	7133	BPR6ES-11	406	2771	UR5	526	2910	AB-6
302	7832	BP5ES	406C2	2771	UR5	533	3210	B-4
302CC	7832	BP5ES	406S	2771	UR5	537	3212	B-6L
302S	7832	BP5ES	407	7060	TR5-1	538	3212	B-6L
304	3623	BPR6EFS	407C2	7060	TR5-1	541	2910	AB-6
304CC	3623	BPR6EFS	407S	7060	TR5-1	541	3010	AB-7
306	7534	B6HS	408	3754	TR4	549	2910	AB-6
306C	7534	B6HS	408C2	2238	TR5	555	2910	AB-6
308	6937	BPR5EY-11	408S	2238	TR5	564	2910	AB-6
308C2	6937	BPR5EY-11	409	2438	WR5	570	5306	LZTR4A-11
309	6263	CR9E	412	4291	ZFR6F-11	570C2	5306	LZTR4A-11
311	4435	ZFR5E-11	412	7252	FR5-1	587	3212	B-6L
312	7331	BP6HS	412C2	7252	FR5-1	592	3522	BR6S
315	2912	BP8ES	412S	7252	FR5-1	592-1	3522	BR6S
318	2262	ZFR5F-11	415	6775	BPR6ES BLYB	592C	3522	BR6S
318C2	2262	ZFR5F-11	415	7131	BPR6ES	592M	3522	BR6S
318S	2262	ZFR5F-11	415-1	7131	BPR6ES	592S	3522	BR6S
322	6773	BPR5ES BLYB	415C2	7131	BPR6ES	593M	3522	BR6S

**NOTE:** Cross references are provided as a GUIDE ONLY. Due to differences in design / materials, products produced by various mfrs may have different specifications. Please refer to specific application guide for proper usage.

**REMARQUE:** Les références sont fournies en GUIDE UNIQUEMENT. En raison des différences de conception et de matériaux, des produits fabriqués par différents fabricants peuvent avoir des spécifications différentes. Veuillez vous référer au guide d'application spécifique pour l'utilisation correcte.





Competitor #	NGK Stock #	NGK Part #	Competitor #	NGK Stock #	NGK Part #	Competitor #	NGK Stock #	NGK Part #
Champion			Champion			Champion		
625	2910	AB-6	818	5722	BR9ES	941-1	4322	BR8HS
653	1491	CR9EB BLYB	818	7548	BR9EYA	941M	4322	BR8HS
653	1493	CR9EK BLYB	818C	5722	BR9ES	942	6945	UR45
653	4548	CR9EK	824	2522	BUHX	942M	6945	UR45
653	6955	CR9EB	824C	2522	BUHX	942S	6945	UR45
654	1275	CR8E	830	1507	BR6HS BLYB	946	6962	BKR6E
654	1482	CR7E BLYB	830	3922	BR6HS	946-1	6962	BKR6E
654	1490	CR8E BLYB	835	5110	B7HS	948	3481	DCPR6E
654	4578	CR7E	835C	5110	B7HS	950M	3741	PZFR5F
661	5281	R2525-10	844	3212	B-6L	952M	7696	PZFR6H
662	2420	D9EA	844-1	3212	B-6L	954	1508	BPR9ES BLYB
667	5281	R2525-10	844S	3212	B-6L	954	7788	BPR9ES
677	6692	BR10HIX	854	3212	B-6L	954C	7788	BPR9ES
678	5687	BR9HIX	857	3112	B-4L	955	3271	PZFR6F-11
709	4216	R0045Q-10	858	7321	BPM7A	955M	3271	PZFR6F-11
796	4644	BKR7E	858-1	7321	BPM7A	955S	3271	PZFR6F-11
801	2411	B8ES	858S	7321	BPM7A	958	7696	PZFR6H
801C	2411	B8ES	871	3522	BR6S	974	2890	BKR5EKUP
803	1111	B7ES	871-1	3522	BR6S	975	3672	LFR6A-11
803C	1111	B7ES	874	4122	BR7HS	975	6376	LFR5A-11
805	2611	B9ES	874-1	4122	BR7HS	977	7411	CPR8E
805C	2611	B9ES	874C	4122	BR7HS	980	7938	BKR5E
806	4111	BP5HS	874M	4122	BR7HS	982	7938	BKR5E
807	5510	B8HS	874S	4122	BR7HS	985	6953	BKR5E-11
807-1	5110	B7HS	880	5422	BR8ES	988	6962	BKR6E
807C	5110	B7HS	880C	5422	BR8ES	990	6799	LZKAR7A
807M	1445	BR7HS BLYB	883	4322	BR8HS	991	6799	LZKAR7A
807M	4122	BR7HS	883-1	4322	BR8HS	992	95897	MR7F
807M	5510	B8HS	883M	1466	BR8HS BLYB	993	6263	CR9E
808	1488	CR7HSA BLYB	883M	4322	BR8HS	1005	2316	DCPR9EIX
808	4549	CR7HSA	883S	4322	BR8HS	1006	5281	R2525-10
809	4179	DCPR8E SOLID	888	6512	D6HA	1025	4492	R6918B-8
809	4339	DCPR8E	889	6821	C8HSA	1026	3130	BR8EG
809	4929	DPR8EA-9	895	3230	BR9EG	1224	3419	BR6HIX
809	7162	DR8EA	896	4210	B5HS	2071	7373	FR5
809	92238	DCPR8E BLYB	900	2641	DCPR9E	2071-4	7373	FR5
809	97058	DR8EA BLYB	904	3923	BPR8ES	2095	7938	BKR5E
809	97768	DPR8EA-9 BLYB	905	4179	DCPR8E SOLID	2301	7634	BPR5E-11
809C	4179	DCPR8E SOLID	909	3754	TR4	2332	7131	BPR6ES
810	3932	DCPR7E	910	6512	D6HA	2338	6962	BKR6E
810	5129	DPR7EA-9	915	3130	BR8EG	2412	7252	FR5-1
810	5531	DPR6EA-9	917C	7832	BP5ES	2412-6	7252	FR5-1
810	91320	DPR7EA-9 BLYB	923	6222	BPR5HS	2415	7734	BPR5ES
810	92482	DPR6EA-9 BLYB	929	7823	BPR4HS	2430	6953	BKR5E-11
810C	4179	DCPR8E SOLID	929C	7823	BPR4HS	3013	3186	TR5GP
810C	96530	DCPR6E BLYB	929G	7823	BPR4HS	3013	3403	TR55GP
810ECO	3932	DCPR7E	930	6945	UR45	3013-2	3186	TR5GP
810S	3932	DCPR7E	931-1	3922	BR6HS	3015	3403	TR55GP
811	5110	B7HS	931M	3922	BR6HS	3015-2	3403	TR55GP
811-1	5110	B7HS	931S	3922	BR6HS	3017	6509	LTR6IX-11
811C	5110	B7HS	932-1	6422	BPR7HS	3018	3207	UR45GP
811M	5110	B7HS	932M	1503	BPR7HS BLYB	3018	3547	UR5GP
811S	5110	B7HS	932M	6422	BPR7HS	3018-2	3547	UR5GP
813	1034	BP7ES	932S	6422	BPR7HS	3024	7159	TR55-1GP
813C	1034	BP7ES	933-1	3922	BR6HS	3025	2869	UR4GP
814	6422	BPR7HS	933M	3922	BR6HS	3025	3207	UR45GP
814C	6422	BPR7HS	933S	3922	BR6HS	3025-2	3207	UR45GP
814S	6422	BPR7HS	934-1	7022	BPR6HS	3026	3186	TR5GP
816	7112	D8HA	934M	7022	BPR6HS	3031	2763	GR4GP
817	5077	ZGR5A	934S	7022	BPR6HS	3031	3142	GR45GP
818	1469	BR9ES BLYB	936-1	5111	BP7HS	3031	7082	BPR5EGP
818	1471	BR9EYA BLYB	936M	5111	BP7HS	3031-2	3142	GR45GP
818	3194	BR9ES SOLID	936S	5111	BP7HS	3032	5019	LTR5GP
818	3961	BR8ES SOLID	937	6853	BPR9EIX	3032-2	5019	LTR5GP

NOTE: Cross references are provided as a GUIDE ONLY. Due to differences in design / materials, products produced by various mfrs may have different specifications. Please refer to specific application guide for proper usage.

426 NOTA: El cruce de referencias servirá únicamente como guía. Las diferencias en diseño, materiales y los productos utilizados para su elaboración pueden variar dependiendo del fabricante. Para obtener la aplicación correcta de su vehículo, por favor referirse a la sección correspondiente dentro de esta guía.





Competitor #	NGK Stock #	NGK Part #	Competitor #	NGK Stock #	NGK Part #	Competitor #	NGK Stock #	NGK Part #
Champion			Champion			Champion		
3034	7090	BKR5EGP	4113	7052	YR5	7412	7252	FR5-1
3034	7781	ZFR5LP-13G	4113-2	7052	YR5	7415	7084	BPR6EGP
3034-2	7781	ZFR5LP-13G	4130	4652	WR4-1	7436	7096	ZFR5EGP
3036	2869	UR4GP	4318	7938	BKR5E	7437	2467	PTR5A-13
3036-2	2869	UR4GP	4401	3623	BPR6EFS	7437-2	2467	PTR5A-13
3066	3692	TR65IX	4404	2635	GR4	7440	4998	PLZTR5A-13
3068	7092	BKR6EGP	4405	7734	BPR5ES	7440-2	4998	PLZTR5A-13
3069	2667	BKR7EIX	4408	2238	TR5	7545	2978	BKR6EP-11
3071	6341	BKR5EIX	4408-2	2238	TR5	7546	2647	PFR5G-11
3071	7092	BKR6EGP	4412	4043	ZFR4F-11	7546-2	2647	PFR5G-11
3071-2	7092	BKR6EGP	4430	2756	BKR6E-11	7548	4292	PFR5R-11
3071S	7092	BKR6EGP	4434	7938	BKR5E	7570	4306	LZTR5A-13
3132	5019	LTR5GP	4436	7938	BKR5E	7570-2	4306	LZTR5A-13
3232	3381	LZTR5AGP	4983	3951	TR55	7622	2316	DCPR9EIX
3318	7098	ZFR5FGP	5071	7938	BKR5E	7712	3271	PZFR6F-11
3318	7100	ZFR6FGP	5071S	7938	BKR5E	7782	6994	IZFR6K11
3318-2	7098	ZFR5FGP	5933	3722	BR5HS	7812	7772	PFR7G-11S
3322	2115	BPR5EIX-11	5942	6630	UR4	7940	3403	TR55GP
3322	7082	BPR5EGP	7000	6737	PZFR5Q-11	7940-2	3403	TR55GP
3322-2	2115	BPR5EIX-11	7004	90117	ILTR6E11	7963	3186	TR5GP
3340	7092	BKR6EGP	7013	7164	TR55IX	7963	7740	PTR5C-13
3340-2	7092	BKR6EGP	7015	3403	TR55GP	7963-2	7740	PTR5C-13
3344	3764	BKR6EIX-11	7015-2	3784	PTR5D-10	7972	2842	PJR7A
3344	7088	BCPR6EGP	7018	3547	UR5GP	7975	4469	LFR5AIX-11
3344	7092	BKR6EGP	7019	4288	PLKR7A	7975	6240	PLFR5A-11
3344-2	3764	BKR6EIX-11	7020	7243	TR5-11X	7975-2	6240	PLFR5A-11
3346	7092	BKR6EGP	7020-2	7159	TR55-1GP	7981	2467	PTR5A-13
3346-2	7092	BKR6EGP	7031	97382	GR4IX	7981-2	2467	PTR5A-13
3401	3403	TR55GP	7031-2	2763	GR4GP	7983	3186	TR5GP
3401-2	3403	TR55GP	7032	3381	LZTR5AGP	7983	4213	IZTR4A11
3405	2763	GR4GP	7032	94806	LTR6BP13	7983-2	3186	TR5GP
3405	7082	BPR5EGP	7032-2	94806	LTR6BP13	8018	6630	UR4
3405-2	2763	GR4GP	7034	7781	ZFR5LP-13G	8018-1	6630	UR4
3407	7243	TR5-11X	7034-2	7781	ZFR5LP-13G	8071	7938	BKR5E
3407-2	7243	TR5-11X	7070	5555	PFR6G-11	8071-1	7938	BKR5E
3408	3403	TR55GP	7071	2647	PFR5G-11	8304	3623	BPR6EFS
3408-2	3403	TR55GP	7071	4363	PZFR5F-11	8304-1	3623	BPR6EFS
3412	3459	ZFR5N	7071-2	2647	PFR5G-11	8332	5534	BPR7ES
3412	7090	BKR5EGP	7072	3440	BKR5EP-11	8332-1	5534	BPR7ES
3412-2	7090	BKR5EGP	7200	7159	TR55-1GP	8332-2	5534	BPR7ES
3415	7084	BPR6EGP	7304	97287	ITR5H13	8339	5534	BPR7ES
3415-2	7084	BPR6EGP	7304-2	97287	ITR5H13	8339-1	5534	BPR7ES
3436	7090	BKR5EGP	7318	3271	PZFR6F-11	8339-2	5534	BPR7ES
3436	7100	ZFR6FGP	7318	7092	BKR6EGP	8401	2238	TR5
3436-2	7090	BKR5EGP	7318-2	7092	BKR6EGP	8401-1	2238	TR5
3470	3381	LZTR5AGP	7322	5760	PGR5C-11	8405	7734	BPR5ES
3470-2	3381	LZTR5AGP	7332	3573	PGR5A-11	8405-1	7734	BPR5ES
3570	3381	LZTR5AGP	7332-2	3573	PGR5A-11	8405-2	7734	BPR5ES
3570	5017	LZTR4AGP	7340	7772	PFR7G-11S	8415	7131	BPR6ES
3570-2	3381	LZTR5AGP	7343	3500	PFR6B	8415-1	7131	BPR6ES
3720	7098	ZFR5FGP	7344	6458	PFR6Q	8415-2	7131	BPR6ES
3890	6341	BKR5EIX	7345	5555	PFR6G-11	8654	1275	CR8E
3980	7090	BKR5EGP	7346	2647	PFR5G-11	8654-1	1275	CR8E
3983	3403	TR55GP	7346-2	2647	PFR5G-11	8654-2	1275	CR8E
3983-2	3403	TR55GP	7348	2761	PFR5G-13E	8698	4578	CR7E
4011	2438	WR5	7401	6579	PTR5F-11	8698-1	4578	CR7E
4013	3951	TR55	7401-2	6579	PTR5F-11	8698-2	4578	CR7E
4018	2771	UR5	7405	3971	BPR5EP-11	8809	5329	DPR9EA-9
4018-2	2771	UR5	7406	5507	PZNR6A11H	8809-1	5329	DPR9EA-9
4019	6945	UR45	7407	7243	TR5-11X	8810	3932	DCPR7E
4025	6945	UR45	7407-2	7243	TR5-11X	8810	7734	BPR5ES
4025-2	6945	UR45	7408	7300	TR4IX	8810-1	3932	DCPR7E
4071	6962	BKR6E	7408	7397	TR5IX	8810-2	3932	DCPR7E
4079	4268	GR45	7408-2	6579	PTR5F-11	8812	3932	DCPR7E

**NOTE:** Cross references are provided as a GUIDE ONLY. Due to differences in design / materials, products produced by various mfrs may have different specifications. Please refer to specific application guide for proper usage.

**REMARQUE:** Les références sont fournies en GUIDE UNIQUEMENT. En raison des différences de conception et de matériaux, des produits fabriqués par différents fabricants peuvent avoir des spécifications différentes. Veuillez vous référer au guide d'application spécifique pour l'utilisation correcte.



Competitor #	NGK Stock #	NGK Part #	Competitor #	NGK Stock #	NGK Part #	Competitor #	NGK Stock #	NGK Part #
Champion			Champion			Champion		
8812-1	3932	DCPR7E	9602	7397	TR5IX	CH60	1239	Y-207T
8814	7022	BPR6HS	9611	4344	LTR5IX-11	CH61	3473	Y-924J
8814-1	7022	BPR6HS	9700	6046	DCPR7EIX	CH68	3473	Y-924J
8814-2	7022	BPR6HS	9701	6546	DCPR8EIX	CH69	3704	Y-918J
8900	7788	BPR9ES	9702	7563	IZKR7B	CH132	2187	Y-118R
8900-1	7788	BPR9ES	9770	5266	IZFR6K-11S	CH189	3473	Y-924J
8902	5722	BR9ES	9775	6619	LFR6AIX-11	CH218	4705	Y-745U
8902-1	5722	BR9ES	9782	1675	PFR7S8EG	CH237	97928	Y1037J
8902-2	5722	BR9ES	9800	7746	IFR7G-11KS	CH243	97190	Y4002J
8904	3923	BPR8ES	9801	2667	BKR7EIX	CH260	3704	Y-918J
8904-1	3923	BPR8ES	9801S	2667	BKR7EIX	CH271	5909	Y-732J
8904-2	3923	BPR8ES	9802	6418	BKR6EIX	CJ6Y	7321	BPM7A
9000	3657	IZFR5K11	9802-2	6418	BKR6EIX	D6	7909	AB-8
9001	6418	BKR6EIX	9802S	6418	BKR6EIX	D9	2910	AB-6
9001-2	6418	BKR6EIX	9803	6441	ZFR6FIX-11	D9J	2910	AB-6
9001S	6418	BKR6EIX	9803S	6441	ZFR6FIX-11	D10	2910	AB-6
9002	6341	BKR5EIX	9804	2115	BPR5EIX-11	D14	2910	AB-6
9002-2	6341	BKR5EIX	9804-2	2115	BPR5EIX-11	D15Y	2910	AB-6
9003	5464	BKR5EIX-11	9805	5344	IFR6D10	D16	2910	AB-6
9003S	5464	BKR5EIX-11	9806	4589	IFR6T11	D16J	2910	AB-6
9006	7854	IFR5G11	9806-2	4589	IFR6T11	D18Y	2910	AB-6
9006S	7854	IFR5G11	9808	7397	TR5IX	D21	2910	AB-6
9007	2115	BPR5EIX-11	9808-2	7397	TR5IX	D23	2910	AB-6
9008	7994	IFR5E11	9808S	7397	TR5IX	D78Y	2910	AB-6
9010	92145	LZFR5CI-11	9812	6994	IZFR6K11	G1	7499	C9E
9013	6341	BKR5EIX	9813	6774	IZFR6K13	G2	7471	C8E
9014	6994	IZFR6K11	9901	91418	ILTR5E11	G54V	4216	R0045Q-10
9016	97177	LTR6CI-8	9901S	91418	ILTR5E11	G55	7499	C9E
9023	93911	LKR7AIX	A5YC	6629	DP9EA-9	G57C	1491	CR9EB BLYB
9030	9723	SILZKR7B11	A6	2120	D8EA	G57C	1493	CR9EK BLYB
9033	93135	DILKR7A11	A6G	6681	DR8EIX	G57C	4548	CR9EK
9034	7781	ZFR5LP-13G	A6GC	6681	DR8EIX	G57C	6955	CR9EB
9035	4912	ILKAR7B11	A6Y	5829	DP8EA-9	G58	7499	C9E
9044	92491	DILFR6J11	A6YC	5829	DP8EA-9	G59C	1275	CR8E
9055	92145	LZFR5CI-11	A8	7912	D7EA	G59C	1482	CR7E BLYB
9055	97606	PLZFR5B13EG	A8Y	5629	DP7EA-9	G59C	1490	CR8E BLYB
9060	93911	LKR7AIX	A8YC	5629	DP7EA-9	G59C	4578	CR7E
9200	7243	TR5-1IX	A10	7912	D7EA	G61	7471	C8E
9201	6418	BKR6EIX	A51R	5281	R2525-10	G63	7471	C8E
9201-2	6418	BKR6EIX	A55R	5281	R2525-10	H8	3212	B-6L
9202	6341	BKR5EIX	A57C	5281	R2525-10	H8C	3212	B-6L
9202-2	6341	BKR5EIX	A57R	5281	R2525-10	H8J	3212	B-6L
9203	6341	BKR5EIX	A59C	2420	D9EA	H10	3212	B-6L
9203-2	6341	BKR5EIX	A61	2420	D9EA	H10C	3212	B-6L
9204	7397	TR5IX	A61G	4772	DR9EIX	H10J	3212	B-6L
9204-2	7397	TR5IX	BL11Y	2771	UR5	H11	3112	B-4L
9204S	7397	TR5IX	BL13Y	6630	UR4	H12	3212	B-6L
9299	90117	ILTR6E11	BN7Y	2238	TR5	H14Y	3212	B-6L
9300	5476	ILTR5D	BN9Y	4177	TR6	J11	3210	B-4
9402	7243	TR5-1IX	BN12Y	2238	TR5	J11C	3210	B-4
9402-2	7164	TR55IX	BN89Y	2238	TR5	J11Y	3332	XR5
9403	2314	LZTR5AIX-13	C6BYC	5509	BCPR7ET	J12YC	2298	R5670-5
9403-2	2314	LZTR5AIX-13	C9MCC	7558	ZFR5F	J13Y	7355	XR5IX
9404	7164	TR55IX	C9Y	6962	BKR6E	J14YC	7355	XR5IX
9404-2	7164	TR55IX	C9YC	6962	BKR6E	K3G	7909	AB-8
9405	7397	TR5IX	C9YCC	6962	BKR6E	K5G	7909	AB-8
9405-2	7397	TR5IX	C10YCC	6962	BKR6E	K7	7909	AB-8
9406	5507	PZNR6A11H	C53	6596	R5671A-11	K8G	7909	AB-8
9407	1989	ILKR7B8	C53C	6596	R5671A-11	K9	3010	AB-7
9408	4288	PLKR7A	C53CX	6596	R5671A-11	K13	2910	AB-6
9409	93911	LKR7AIX	C63Y	4644	BKR7E	K15J	2910	AB-6
9410	4912	ILKAR7B11	C63YC	4644	BKR7E	K-8	7909	AB-8
9412	4912	ILKAR7B11	C65YC	4644	BKR7E	KC10PYPB4	4292	PFR5R-11
9440	2314	LZTR5AIX-13	C281YC	6962	BKR6E	KC11PYP	2761	PFR5G-13E

NOTE: Cross references are provided as a GUIDE ONLY. Due to differences in design / materials, products produced by various mfrs may have different specifications. Please refer to specific application guide for proper usage.

428 NOTA: El cruce de referencias servirá únicamente como guía. Las diferencias en diseño, materiales y los productos utilizados para su elaboración pueden variar dependiendo del fabricante. Para obtener la aplicación correcta de su vehículo, por favor referirse a la sección correspondiente dentro de esta guía.



Competitor #	NGK Stock #	NGK Part #	Competitor #	NGK Stock #	NGK Part #	Competitor #	NGK Stock #	NGK Part #
Champion			Champion			Champion		
L2G	5810	B9HS	N7BYC	1263	BP6ET	P-A7HC	7912	D7EA
L3G	5510	B8HS	N7GY	4055	BPR7EIX	PG2PHP	5851	PMR8A
L4G	5110	B7HS	N7Y	1034	BP7ES	PG4PHP	4259	PMR7A
L4J	5110	B7HS	N7YC	1034	BP7ES	P-G7C	5096	C7E
L5	5110	B7HS	N7YCC	1034	BP7ES	P-L7YC4	6326	BP6HS-10
L6G	5110	B7HS	N7YCX	1034	BP7ES	P-L9YC	7331	BP6HS
L7J	7534	B6HS	N8	7432	B6ES	P-N5C	2411	B8ES
L9G	7534	B6HS	N8GY	6637	BPR6EIX	PRA7HC	7803	DPR7EIX-9
L9J	7534	B6HS	N8L	6334	ZGR5C	P-RL5SC	4296	BR6HSA
L10	7534	B6HS	N8Y	7333	BP6ES	PRZ9HC	4549	CR7HSA
L12Y	4111	BP5HS	N9BMC	5685	BPR5EKU	P-Z7HC	4629	C7HSA
L15Y	3611	BP4HS	N9BYC	1263	BP6ET	P-Z9HC	3228	C6HSA
L55G	2399	B10HS	N9Y	7333	BP6ES	P-Z9HC	7223	CR7HS
L64Y	5111	BP7HS	N9YC	7333	BP6ES	QC9MC4	2262	ZFR5F-11
L66Y	7331	BP6HS	N9YCC	7333	BP6ES	QC10PEP	7696	PZFR6H
L77J	5110	B7HS	N9YCE	7333	BP6ES	QC12GMC	3741	PZFR5F
L77JC	5110	B7HS	N10PY	6637	BPR6EIX	QC12PEPA	7696	PZFR6H
L78	5110	B7HS	N10Y	7333	BP6ES	QC12YC	6962	BKR6E
L78C	1445	BR7HS BLYB	N11Y	7832	BP5ES	QC12YC	7938	BKR5E
L78C	4122	BR7HS	N11YC	7832	BP5ES	QC57	4492	R6918B-8
L78C	5510	B8HS	N11YCC	7832	BP5ES	QC59	3130	BR8EG
L78YC	5111	BP7HS	N12Y	7832	BP5ES	QL7J5	3922	BR6HS
L78YC S	5111	BP7HS	N12YC	7832	BP5ES	QL55	6692	BR10HIX
L81	5110	B7HS	N12YCC	7832	BP5ES	QL57	5687	BR9HIX
L81Y	5111	BP7HS	N13L	6334	ZGR5C	QL77CC	4322	BR8HS
L82	7534	B6HS	N13Y	7832	BP5ES	QL78C	1466	BR8HS BLYB
L82C	5110	B7HS	N14LY	6334	ZGR5C	QL78C	4322	BR8HS
L82CSOLID	5110	B7HS	N14Y	7832	BP5ES	QL78C S	4322	BR8HS
L82Y	7331	BP6HS	N54R	3630	B10EG	QL82C	3922	BR6HS
L82YC	5111	BP7HS	N57	7928	B10ES	QL82C S	3922	BR6HS
L82YCC	7331	BP6HS	N57G	6801	BR10EIX	QL82YC	1503	BPR7HS BLYB
L85	7534	B6HS	N57R	3630	B10EG	QL82YC	6422	BPR7HS
L86	7534	B6HS	N59G	6801	BR10EIX	QL82YC S	6422	BPR7HS
L86C	7534	B6HS	N60	2611	B9ES	QL86	3922	BR6HS
L86CC	7534	B6HS	N60R	3430	B8EG	QL86C	3922	BR6HS
L87Y	7331	BP6HS	N62R	3430	B8EG	QL86C S	3922	BR6HS
L87YC	7331	BP6HS	N63Y	2912	BP8ES	QL87YC	7022	BPR6HS
L87YCC	7331	BP6HS	N64Y	2912	BP8ES	QL87YC S	7022	BPR6HS
L89CM	4111	BP5HS	N65Y	1034	BP7ES	QN2	5722	BR9ES
L90	4210	B5HS	N66Y	7333	BP6ES	QN2C	5722	BR9ES
L90C	4210	B5HS	N74C	7037	BUR6EB-11	QN2G	3981	BR9EIX
L92LCC	6222	BPR5HS	N79Y	7333	BP6ES	QN3	5422	BR8ES
L92Y	4111	BP5HS	N80	3630	B10EG	QN3C	5422	BR8ES
L92YC	4111	BP5HS	N80G	6801	BR10EIX	QN84	3230	BR9EG
L95Y	3611	BP4HS	N82	3630	B10EG	QN86	3130	BR8EG
L288	4210	B5HS	N82G	6801	BR10EIX	R6G	6681	DR8EIX
N1	7928	B10ES	N84	3530	B9EG	R8	7912	D7EA
N2	2611	B9ES	N84G	6801	BR10EIX	RA2HC	2641	DCPR9E
N2C	2611	B9ES	N86	3530	B9EG	RA4HC	4179	DCPR8E SOLID
N2G	2611	B9ES	N86G	3981	BR9EIX	RA4HCX	2316	DCPR9EIX
N3	2411	B8ES	N87	3430	B8EG	RA4PHP	5851	PMR8A
N3C	2411	B8ES	N87G	5044	BR8EIX	RA6	7162	DR8EA
N3G	2411	B8ES	N89Y	7832	BP5ES	RA6HC	4179	DCPR8E SOLID
N4	1111	B7ES	N279YC	1034	BP7ES	RA6HC	4339	DCPR8E
N4C	1111	B7ES	N281YC	7333	BP6ES	RA6HC	4929	DPR8EA-9
N4G	1111	B7ES	N288	6410	B5ES	RA6HC	7162	DR8EA
N5	7432	B6ES	ON3	5422	BR8ES	RA6HC	92238	DCPR8E BLYB
N5C	2411	B8ES	ON11Y	7734	BPR5ES	RA6HC	97058	DR8EA BLYB
N5G	7432	B6ES	ON12Y	7734	BPR5ES	RA6HC	97768	DPR8EA-9 BLYB
N6	7432	B6ES	P7	7112	D8HA	RA6Y	4929	DPR8EA-9
N6Y	2912	BP8ES	P8Y	6512	D6HA	RA6YC	4929	DPR8EA-9
N6YC	2912	BP8ES	P10Y	6512	D6HA	RA8GHC	3481	DCPR6E
N6YCC	2912	BP8ES	P76	7112	D8HA	RA8HC	3932	DCPR7E
N7	1111	B7ES	P-A5HC	7912	D7EA	RA8HC	5129	DPR7EA-9

**NOTE:** Cross references are provided as a GUIDE ONLY. Due to differences in design / materials, products produced by various mfrs may have different specifications. Please refer to specific application guide for proper usage.

**REMARQUE:** Les références sont fournies en GUIDE UNIQUEMENT. En raison des différences de conception et de matériaux, des produits fabriqués par différents fabricants peuvent avoir des spécifications différentes. Veuillez vous référer au guide d'application spécifique pour l'utilisation correcte.



Competitor #	NGK Stock #	NGK Part #	Competitor #	NGK Stock #	NGK Part #	Competitor #	NGK Stock #	NGK Part #
<b>Champion</b>			<b>Champion</b>			<b>Champion</b>		
RA8HC	5531	DPR6EA-9	RC12ECC	3459	ZFR5N	RF9YC	2438	WR5
RA8HC	91320	DPR7EA-9 BLYB	RC12LC4	2262	ZFR5F-11	RF10	3323	AR6FS
RA8HC	92482	DPR6EA-9 BLYB	RC12LC4	4291	ZFR6F-11	RF10C	3323	AR6FS
RA8HC	96530	DCPR6E BLYB	RC12LC4	7100	ZFR6FGP	RF11YC	2438	WR5
RA8PHP	2842	PJR7A	RC12LYC	4291	ZFR6F-11	RF14C	4652	WR4-1
RA8WHP	6546	DCPR8EIX	RC12LYC	7252	FR5-1	RF14YC	2438	WR5
RA8Y	5129	DPR7EA-9	RC12LYC5	2262	ZFR5F-11	RF18YC	2438	WR5
RA8YC	5129	DPR7EA-9	RC12MC4	2262	ZFR5F-11	RFN14LY	7252	FR5-1
RA10HC	3481	DCPR6E	RC12MC5	2262	ZFR5F-11	RG4HC	6263	CR9E
RA59GC	5281	R2525-10	RC12MCC4	2262	ZFR5F-11	RG4PHP	95897	MR7F
RA59PP	2316	DCPR9EIX	RC12MCC4	6987	ZFR6F-11G	RG4YCX	95897	MR7F
RAX92C	3437	DR9EA	RC12PEC5	7090	BKR5EGP	RG6HCC	3521	CR9EIX
RAX92DC	6193	JR9C	RC12PEC5	7781	ZFR5LP-13G	RG6HCC	6263	CR9E
RAX92YC	5329	DPR9EA-9	RC12PEPB	2890	BKR5EKUP	RG6YC	7411	CPR8E
RAX94C	7162	DR8EA	RC12PMC4	7100	ZFR6FGP	RG6YCA	7411	CPR8E
RAX94YC	4929	DPR8EA-9	RC12PMPB4	3271	PZFR6F-11	RG92C	6263	CR9E
RAX96C	7839	DR7EA	RC12PYP	2647	PFR5G-11	RG92DC	4548	CR9EK
RAX96YC	5129	DPR7EA-9	RC12PYP3	3440	BKR5EP-11	RG94C	1275	CR8E
RBN9Y	3623	BPR6EFS	RC12YC	6719	BKR5E BLYB	RGU92C	7502	CR9EH-9
RC6WYPB3	5266	IZFR6K-11S	RC12YC	7938	BKR5E	RGU94C	5666	CR8EH-9
RC6WYPB4	7746	IFR7G-11KS	RC12YC5	6953	BKR5E-11	RH8C	3212	B-6L
RC6YC	4644	BKR7E	RC12YV5	6953	BKR5E-11	RH10C	3212	B-6L
RC7GYG	6418	BKR6EIX	RC14E5	7252	FR5-1	RH12	3212	B-6L
RC7PYCB	7092	BKR6EGP	RC14YC	7938	BKR5E	RH18Y	3112	B-4L
RC7PYCB4	7092	BKR6EGP	RC14YC4	6953	BKR5E-11	RJ6	3522	BR6S
RC7PYCBX	2667	BKR7EIX	RC78PYP	4853	PFR7B	RJ6C	3522	BR6S
RC7Y	4644	BKR7E	RC89TMC	6962	BKR6E	RJ6J	3522	BR6S
RC7YC	4644	BKR7E	RD9	2910	AB-6	RJ7	3522	BR6S
RC7YC3	4644	BKR7E	RD14	2910	AB-6	RJ8	3522	BR6S
RC7YC4	5791	BKR7E-11	RD15Y	2910	AB-6	RJ8C	3522	BR6S
RC7YCC	4644	BKR7E	RD16	2910	AB-6	RJ8J	3522	BR6S
RC7YCC4	5791	BKR7E-11	RD16	3010	AB-7	RJ11	3522	BR6S
RC8PYP	4793	PFR6G	RD16J	2910	AB-6	RJ12	3522	BR6S
RC8PYP4	5555	PFR6G-11	RDZ8H	2086	CR8HSA	RJ12C	3522	BR6S
RC8WYPB3	2667	BKR7EIX	RE7PYP6	2467	PTR5A-13	RJ12YC	3332	XR5
RC8YC4	2756	BKR6E-11	RE10LC	7243	TR5-11X	RJ14YC	5858	XR4
RC8ZWYPB4	6994	IZFR6K11	RE10PM5	5019	LTR5GP	RJ18YC	5858	XR4
RC8ZWYPB5	6774	IZFR6K13	RE10PMC5	5019	LTR5GP	RJ18YC6	4536	XR45
RC9BMC	3964	BKR5EKU	RE10PMPB5	94806	LTR6BP13	RL4J	4122	BR7HS
RC9MC4	2262	ZFR5F-11	RE10WYPB5	91418	ILTR5E11	RL7J	3922	BR6HS
RC9MCC	7558	ZFR5F	RE14MCC4	5306	LZTR4A-11	RL12Y	6222	BPR5HS
RC9PYC	7092	BKR6EGP	RE14MCC5	4306	LZTR5A-13	RL77J	4122	BR7HS
RC9TMC	7969	BKR6EKUB	RE14PLP5	4998	PLZTR5A-13	RL78	4122	BR7HS
RC9Y	6962	BKR6E	RE14PMC	3381	LZTR5AGP	RL78C	4122	BR7HS
RC9YC	6962	BKR6E	RE14PMC	5017	LZTR4AGP	RL82	3922	BR6HS
RC9YC4	2756	BKR6E-11	RE14PMC5	5017	LZTR4AGP	RL82C	4122	BR7HS
RC9YC5	2756	BKR6E-11	RE16MC	5306	LZTR4A-11	RL82C S	4122	BR7HS
RC9YCC	6962	BKR6E	REA6MC	6799	LZKAR7A	RL82Y	7022	BPR6HS
RC9YCN4	2756	BKR6E-11	REA8MC	6799	LZKAR7A	RL82YC	6422	BPR7HS
RC10DMC	7797	BKR5EK	REA8MCL	6799	LZKAR7A	RL82YCC	6422	BPR7HS
RC10ECC	7696	PZFR6H	REA8MCX	6799	LZKAR7A	RL85	3922	BR6HS
RC10MCC	90318	ZFR6U-9	REA12WMB4	4912	ILKAR7B11	RL85G	3419	BR6HIX
RC10PEC	3459	ZFR5N	REC8WMPB4	92491	DILFR6J11	RL86	3922	BR6HS
RC10PYP4	2647	PFR5G-11	REC8WYPB3	9723	SILZKR7B11	RL86C	1507	BR6HS BLYB
RC10PYP4B4	5838	PFR5N-11	REC8WYPB4	93135	DILKR7A11	RL86C	3922	BR6HS
RC10PYPB4	2647	PFR5G-11	REC10WMPB	92145	LZFR5CI-11	RL87Y	7022	BPR6HS
RC10VTYC4	7808	BKUR6ET	REC10WYPB4	7854	IFR5G11	RL87YC	7022	BPR6HS
RC10WYPB5	7994	IFR5E11	REC10YC4	3672	LFR6A-11	RL90	3722	BR5HS
RC10YC4	2756	BKR6E-11	REC10YC4	6376	LFR5A-11	RL95YC	7823	BPR4HS
RC10YCC4	6953	BKR5E-11	REC12MCC4	92174	LZFR5C-11	RN2	5722	BR9ES
RC10ZWYPB4	3657	IZFR5K11	REC12WMPB5	92145	LZFR5CI-11	RN2C	1469	BR9ES BLYB
RC11PYPB4	5555	PFR6G-11	RER8MC	1643	LKR7E	RN2C	1471	BR9EYA BLYB
RC11PYPB4	3546	PFR6N-11	RER8ZWYCB4	1989	ILKR7B8	RN2C	3194	BR9ES SOLID
RC11ZYC4	4435	ZFR5E-11	RET8ZWMPB4	5507	PZNR6A11H	RN2C	3961	BR8ES SOLID

**NOTE:** Cross references are provided as a GUIDE ONLY. Due to differences in design / materials, products produced by various mfrs may have different specifications. Please refer to specific application guide for proper usage.

430 **NOTA:** El cruce de referencias servirá únicamente como guía. Las diferencias en diseño, materiales y los productos utilizados para su elaboración pueden variar dependiendo del fabricante. Para obtener la aplicación correcta de su vehículo, por favor referirse a la sección correspondiente dentro de esta guía.



Competitor #	NGK Stock #	NGK Part #	Competitor #	NGK Stock #	NGK Part #	Competitor #	NGK Stock #	NGK Part #
<b>Champion</b>			<b>Champion</b>			<b>Champion</b>		
RN2C	5722	BR9ES	RN79PYP25	6637	BPR6EIX	UN79Y	7333	BP6ES
RN2C	7548	BR9EYA	RP7	5123	DR8HS	V9YC	7348	UR6IX
RN2G	3981	BR9EIX	RS5C	1094	BR7EFS	V12YC	7177	UR5IX
RN3	5422	BR8ES	RS8WYPB5	7397	TR5IX	XC10YC	6962	BKR6E
RN3C	5422	BR8ES	RS9PYP4	97287	ITR5H13	XC12PEPB	3271	PZFR6F-11
RN4	5122	BR7ES	RS9YC	3623	BPR6EFS	XC12YC	7938	BKR5E
RN4C	5122	BR7ES	RS9YCC	3623	BPR6EFS	XC92PYC	7090	BKR5EGP
RN4YC	3923	BPR8ES	RS10LC	7060	TR5-1	XC92YC	7938	BKR5E
RN5	4922	BR6ES	RS12PLP	7243	TR5-11X	XG4YCX	95897	MR7F
RN5C	4922	BR6ES	RS12PYP	6579	PTR5F-11	YX10YC	6962	BKR6E
RN6	4922	BR6ES	RS12PYPB5	7740	PTR5C-13	Z6	6821	C8HSA
RN6Y	3923	BPR8ES	RS12YC	2238	TR5	Z8	4629	C7HSA
RN6YC	3785	BPR7ES SOLID	RS12YC	3623	BPR6EFS	Z9Y	1488	CR7HSA BLYB
RN7Y	5534	BPR7ES	RS12YC	3754	TR4	Z9Y	4549	CR7HSA
RN7YC	7131	BPR6ES	RS12YC6	3951	TR55	Z10	3228	C6HSA
RN7YCC	5534	BPR7ES	RS13LYC	3754	TR4	Z12	3228	C6HSA
RN8	5866	BR5ES	RS13LYC5	2238	TR5	<b>Cummins</b>		
RN8L	6334	ZGR5C	RS14LC	7060	TR5-1	167-0237	3212	B-6L
RN9BMC	5685	BPR5EY	RS14LYC	3754	TR4	167-0263-02	7823	BPR4HS
RN9GY	6637	BPR6EIX	RS14PLP	7243	TR5-11X	167-0272	3754	TR4
RN9Y	7131	BPR6ES	RS14PMPB5	4213	IZTR4A11	167-0275	7734	BPR5ES
RN9YC	6775	BPR6ES BLYB	RS14PYP6	3403	TR55GP	<b>DENSO</b>		
RN9YC	7131	BPR6ES	RS14PYP	7300	TR4IX	2202	2202	DPR8EIX-9
RN9YC4	7133	BPR6ES-11	RS14PYP	7397	TR5IX	2707	2707	BR9ECMIX
RN9YCC	7131	BPR6ES	RS14PYP6	7164	TR55IX	3001	6334	ZGR5C
RN10GY	6637	BPR6EIX	RS14YC	2238	TR5	3002	6334	ZGR5C
RN10PYP4	3573	PGR5A-11	RS14YC	3754	TR4	3004	3971	BPR5EP-11
RN10WYPB5	2115	BPR5EIX-11	RS14YC6	3951	TR55	3005	2097	BCPR5EP-11
RN10Y	7131	BPR6ES	RS15LYC	3754	TR4	3006	2441	BCPR5EY-11
RN10Y4	7133	BPR6ES-11	RS17YX	3754	TR4	3007	2330	BCPR6ES
RN11Y	7734	BPR5ES	RV8C6	7240	YR55	3008	5632	BCPR6E-11
RN11YC	7734	BPR5ES	RV9YC	7773	UR6	3010	6282	BCPR7ES
RN11YC4	6773	BPR5ES BLYB	RV12C	7052	YR5	3015	4268	GR45
RN11YC4	7634	BPR5ES-11	RV12C6	7240	YR55	3016	6735	BUR5EB-11
RN11YCC	7734	BPR5ES	RV12YC	2771	UR5	3018	7832	BP5ES
RN12GY	6597	BPR5EIX	RV12YC6	2248	UR55	3019	97382	GR4IX
RN12MC4	6937	BPR5EY-11	RV15YC	6630	UR4	3020	7634	BPR5ES-11
RN12Y	7734	BPR5ES	RV15YC4	6630	UR4	3021	7734	BPR5ES
RN12YC	7734	BPR5ES	RV15YC6	6945	UR45	3022	2851	GR5
RN12YC4	7634	BPR5ES-11	RV17PMC4	3207	UR45GP	3022	7634	BPR5ES-11
RN12YC6	7634	BPR5ES-11	RV17YC	6630	UR4	3023	5866	BR5ES
RN12YCC	7734	BPR5ES	RV17YC6	6945	UR45	3024	5866	BR5ES
RN13L	6334	ZGR5C	RV19YC	6630	UR4	3025	6410	B5ES
RN13LYC	6334	ZGR5C	RV19YC6	6945	UR45	3030	6597	BPR5EIX
RN13LYC5	5077	ZGR5A	RV91MC	6945	UR45	3031	1233	BPR5EY
RN14LY	6334	ZGR5C	RV92YC	6945	UR45	3031	2635	GR4
RN14MC5	4268	GR45	RZ94C	2086	CR8HSA	3031	7734	BPR5ES
RN14PMC	7082	BPR5EGP	RZ96C	4549	CR7HSA	3032	6937	BPR5EY-11
RN14PMC5	7082	BPR5EGP	RZN12Y	7397	TR5IX	3033	3722	BR5HS
RN14PMP5	97382	GR4IX	RZN12Y5	7397	TR5IX	3034	4210	B5HS
RN14Y	2635	GR4	S9YC	3623	BPR6EFS	3035	3212	B-6L
RN14Y6	4268	GR45	S10YCC	7397	TR5IX	3036	4210	B5HS
RN14YC	2635	GR4	S12YC	7397	TR5IX	3037	3722	BR5HS
RN14YC	6578	BPR4ES SOLID	S279YC	3623	BPR6EFS	3041	7037	BUR6EB-11
RN14YC	7734	BPR5ES	S281YC	3623	BPR6EFS	3043	7333	BP6ES
RN14YC	97226	BPR4ES BLYB	TE10PMC5	3381	LZTR5AGP	3045	6637	BPR6EIX
RN16YC5	2264	BPR2ES	UD16	2910	AB-6	3046	4690	BUR6EA-11
RN16YC5	4268	GR45	UJ11G	3210	B-4	3047	7131	BPR6ES
RN16YC5	6770	BPR2ES BLYB	UJ12	3522	BR6S	3048	7133	BPR6ES-11
RN57YC	6853	BPR9EIX	UK10	2910	AB-6	3049	7133	BPR6ES-11
RN57YCC	1508	BPR9ES BLYB	UL4J	5110	B7HS	3051	7432	B6ES
RN57YCC	7788	BPR9ES	UL18V	2522	BUHX	3053	7432	B6ES
RN74C	7037	BUR6EB-11	UL81C	5110	B7HS	3054	7432	B6ES
RN79PYP17	6637	BPR6EIX	UL81J	5110	B7HS	3056	4922	BR6ES

**NOTE:** Cross references are provided as a GUIDE ONLY. Due to differences in design / materials, products produced by various mfrs may have different specifications. Please refer to specific application guide for proper usage.

**REMARQUE:** Les références sont fournies en GUIDE UNIQUEMENT. En raison des différences de conception et de matériaux, des produits fabriqués par différents fabricants peuvent avoir des spécifications différentes. Veuillez vous référer au guide d'application spécifique pour l'utilisation correcte.





Competitor #	NGK Stock #	NGK Part #	Competitor #	NGK Stock #	NGK Part #	Competitor #	NGK Stock #	NGK Part #
DENSO			DENSO			DENSO		
3057	4922	BR6ES	3135	4435	ZFR5E-11	3234	6546	DCPR8EIX
3062	7333	BP6ES	3135	4936	ZFR5D-11	3235	7558	ZFR5F
3065	6637	BPR6EIX	3137	5155	FR4	3237	4043	ZFR4F-11
3066	6427	BPR6EY	3137	6130	BCPR5ES	3238	7084	BPR6EGP
3067	6261	BPR6EY-11	3137	7938	BKR5E	3239	3573	PGR5A-11
3068	7331	BP6HS	3138	4497	BCPR6EP-N-11	3240	2763	GR4GP
3069	4632	BPR6HSA	3139	5553	BKR6ES-11	3242	6046	DCPR7EIX
3070	7022	BPR6HS	3140	2330	BCPR6ES	3243	6546	DCPR8EIX
3072	3922	BR6HS	3141	2743	PFR6J-11	3244	3350	BCPR6EP-11
3073	7534	B6HS	3142	3546	PFR6N-11	3245	2743	PFR6J-11
3074	3419	BR6HIX	3142	5555	PFR6G-11	3246	4363	PZFR5F-11
3076	3522	BR6S	3142	6458	PFR6Q	3247	3271	PZFR6F-11
3077	6931	BR6EB-L-11	3143	2391	BKR5E-N-11	3252	7746	IFR7G-11KS
3078	6931	BR6EB-L-11	3145	6962	BKR6E	3253	3452	BKR6EKP-11
3079	5877	BR7ET	3149	5583	R6254E-9	3255	5690	BCPR7EIX
3081	5877	BR7ET	3150	5583	R6254E-9	3256	5077	ZGR5A
3082	5877	BR7ET	3152	3306	BCPR5EIX-11	3257	5691	BCPR7EIX-11
3085	1034	BP7ES	3153	4919	BCPR6EIX-11	3262	3764	BKR6EIX-11
3086	4055	BPR7EIX	3154	3306	BCPR5EIX-11	3264	2300	PFR5B-11
3088	5534	BPR7ES	3155	4919	BCPR6EIX-11	3265	4853	PFR7B
3089	3089	BR9EIX SOLID	3156	3306	BCPR5EIX-11	3266	3306	BCPR5EIX-11
3089	7226	BPR7ES-11	3157	4919	BCPR6EIX-11	3267	1041	ZFR6A-11
3091	5122	BR7ES	3158	5690	BCPR7EIX	3268	2633	BPR6HS-10
3092	6832	BUR7EB-11	3160	5464	BKR5EIX-11	3270	3573	PGR5A-11
3093	1111	B7ES	3161	5464	BKR5EIX-11	3271	6046	DCPR7EIX
3095	6664	BR7EIX	3162	3764	BKR6EIX-11	3273	4853	PFR7B
3096	5122	BR7ES	3163	3764	BKR6EIX-11	3274	3923	BPR8ES
3097	5122	BR7ES	3164	6988	BKR7EIX-11	3275	5459	PFR5L-11
3098	5122	BR7ES	3165	4644	BKR7E	3276	6962	BKR6E
3099	1034	BP7ES	3166	5464	BKR5EIX-11	3277	6757	BPR6EKN
3100	6612	BR8ET	3167	4043	ZFR4F-11	3278	3481	DCPR6E
3102	6612	BR8ET	3168	4014	PFR6B-11	3279	6757	BPR6EKN
3103	6612	BR8ET	3170	6832	BUR7EB-11	3281	4055	BPR7EIX
3104	2329	BR8EQ-14	3172	3141	PFR6L-13	3283	3481	DCPR6E
3105	5777	BUR9EQ	3173	3271	PZFR6F-11	3284	7772	PFR7G-11S
3106	6917	BUR7EQ	3174	4642	PFR5J-11	3289	4302	BKR5EKP-11
3108	5370	BUR4EB-11	3175	3741	PZFR5F	3290	2667	BKR7EIX
3110	5866	BR5ES	3176	3932	DCPR7E	3291	6637	BPR6EIX
3111	5777	BUR9EQ	3177	4339	DCPR8E	3292	5555	PFR6G-11
3112	1041	ZFR6A-11	3178	3481	DCPR6E	3293	6371	FR5AP-10
3113	5275	BCPR6EP-N-8	3179	3932	DCPR7E	3295	5084	ZFR5A-11
3114	3573	PGR5A-11	3182	2756	BKR6E-11	3297	4589	IFR6T11
3115	7084	BPR6EGP	3182	3735	BCPR6E	3299	5791	BKR7E-11
3116	6637	BPR6EIX	3191	7938	BKR5E	3300	2647	PFR5G-11
3117	3350	BCPR6EP-11	3192	5791	BKR7E-11	3301	2300	PFR5B-11
3118	5077	ZGR5A	3194	3967	BKR5EKB-11	3302	3200	PGR7A
3119	2087	BKR5EYA	3195	3452	BKR6EKP-11	3303	3508	IFR5T-8N
3120	2526	BKR5EYA-11	3196	2288	BKR6EK	3304	4959	BKR6EKC
3121	2756	BKR6E-11	3199	6937	BPR5EY-11	3305	2288	BKR6EK
3122	3696	BKR6EY	3200	7226	BPR7ES-11	3306	4984	PGR6A
3123	2097	BCPR5EP-11	3201	7634	BPR5ES-11	3311	2262	ZFR5F-11
3125	3735	BCPR6E	3203	7734	BPR5ES	3312	4339	DCPR8E
3127	2215	BKR6EP-8	3204	7131	BPR6ES	3313	2641	DCPR9E
3128	2978	BKR6EP-11	3205	7734	BPR5ES	3314	2316	DCPR9EIX
3129	1266	BCPR5EY	3206	7133	BPR6ES-11	3316	5534	BPR7ES
3130	6953	BKR5E-11	3212	6261	BPR6EY-11	3319	2329	BR8EQ-14
3131	2262	ZFR5F-11	3216	5685	BPR5EY-11	3320	6855	ZFR7F-11
3131	4435	ZFR5E-11	3222	6937	BPR5EY-11	3322	4497	BCPR6EP-N-11
3131	5584	ZFR5J-11	3223	4793	PFR6G	3323	3903	BPR6EIX-11
3132	2262	ZFR5F-11	3226	4115	PFR6G-13	3324	4996	IFR5T11
3132	5584	ZFR5J-11	3229	7084	BPR6EGP	3326	6737	PZFR5Q-11
3133	2262	ZFR5F-11	3230	2763	GR4GP	3329	7797	BKR5EK
3133	4291	ZFR6F-11	3231	6597	BPR5EIX	3334	6988	BKR7EIX-11
3134	3440	BKR5EP-11	3233	6046	DCPR7EIX	3335	4589	IFR6T11

NOTE: Cross references are provided as a GUIDE ONLY. Due to differences in design / materials, products produced by various mfrs may have different specifications. Please refer to specific application guide for proper usage.

432 NOTA: El cruce de referencias servirá únicamente como guía. Las diferencias en diseño, materiales y los productos utilizados para su elaboración pueden variar dependiendo del fabricante. Para obtener la aplicación correcta de su vehículo, por favor referirse a la sección correspondiente dentro de esta guía.





Competitor #	NGK Stock #	NGK Part #	Competitor #	NGK Stock #	NGK Part #	Competitor #	NGK Stock #	NGK Part #
DENSO			DENSO			DENSO		
3348	6855	ZFR7F-11	4004	2983	CR6HSA	4104	7112	D8HA
3353	4996	IFR5T11	4006	4629	C7HSA	4105	5123	DR8HS
3354	3106	IGR7A-G	4007	7544	CR7HIX	4106	4730	DPR8Z
3356	7994	IFR5E11	4008	4549	CR7HSA	4108	6629	DP9EA-9
3370	3741	PZFR5F	4009	6821	C8HSA	4109	5545	DPR9EIX-9
3371	4095	IZFR6F11	4010	2086	CR8HSA	4111	5329	DPR9EA-9
3371	6994	IZFR6K11	4013	3611	BP4HS	4112	5545	DPR9EIX-9
3372	7746	IFR7G-11KS	4014	3611	BP4HS	4114	2420	D9EA
3373	2215	BKR6EP-8	4015	3611	BP4HS	4115	4772	DR9EIX
3373	4867	IFR6B-K	4016	7823	BPR4HS	4116	3437	DR9EA
3373	6418	BKR6EIX	4018	6597	BPR5EIX	4117	4830	DPR9Z
3374	2756	BKR6E-11	4019	4111	BP5HS	4122	4772	DR9EIX
3377	6994	IZFR6K11	4020	6222	BPR5HS	4123	6801	BR10EIX
3381	7787	LFR6C-11	4021	5111	BP7HS	4124	6334	ZGR5C
3395	3107	IFR5G-11K	4022	6422	BPR7HS	4125	5531	DPR6EA-9
3396	4363	PZFR5F-11	4024	4122	BR7HS	4126	1275	CR8E
3401	6994	IZFR6K11	4025	5110	B7HS	4127	5666	CR8EH-9
3403	6741	IFR6E11	4026	7067	BR7HIX	4128	7499	C9E
3412	5464	BKR5EIX-11	4028	2912	BP8ES	4129	7502	CR9EH-9
3417	6240	PLFR5A-11	4030	2411	B8ES	4130	3188	JR9B
3417	96779	ILFR5T11	4031	2411	B8ES	4131	6263	CR9E
3418	6741	IFR6E11	4032	5044	BR8EIX	4132	3521	CR9EIX
3419	7746	IFR7G-11KS	4033	5422	BR8ES	4134	6482	CR10EIX
3421	4904	ILFR6T11	4034	5044	BR8EIX	4135	2360	CR10EK
3422	3657	IZFR5K11	4035	3130	BR8EG	4136	3923	BPR8ES
3426	6176	DILFR6D11	4037	4322	BR8HS	4137	5096	C7E
3431	6418	BKR6EIX	4038	5510	B8HS	4138	2399	B10HS
3432	5266	IZFR6K-11S	4039	7001	BR8HIX	4142	6216	CR9EHIX-9
3433	4458	ILFR6J-11K	4041	3430	B8EG	4143	6216	CR9EHIX-9
3434	91715	IKR7H8	4042	7001	BR8HIX	4144	2707	BR9ECMIX
3435	3508	IFR5T-8N	4043	3530	B9EG	4148	4111	BP5HS
3436	9029	DILKAR6A11	4045	5722	BR9ES	4155	4548	CR9EK
3437	1313	FR5EI	4046	2611	B9ES	4158	3478	CR8EK
3439	9029	DILKAR6A11	4047	3530	B9EG	4159	3252	BR9ECM
3441	1989	ILKR7B8	4048	3981	BR9EIX	4160	4234	BR10ECM
3442	1406	DILKAR7B11	4049	3230	BR9EG	4161	4296	BR6HSA
3443	92085	IFR6V-10G	4050	5687	BR9HIX	4162	5869	ER9EH
3444	4912	ILKAR7B11	4052	5810	B9HS	4165	1068	DP6EA-9
3445	5847	LKR7B-9	4053	5687	BR9HIX	4166	3981	BR9EIX
3449	3764	BKR6EIX-11	4054	4522	BR9HS	4167	6681	DR8EIX
3450	93759	DILFR5A11	4057	6801	BR10EIX	4169	6482	CR10EIX
3457	96024	ILKAR8H6	4058	3630	B10EG	4171	7840	CR5HSA
3458	98376	DILFR5A-11D	4059	3830	BR10EG	4172	4772	DR9EIX
3461	5787	ILZKR7B-11S	4060	3630	B10EG	4173	4677	BR9ECS
3471	5547	PFR6W-TG	4062	7928	B10ES	4174	4578	CR7E
3473	6858	DFH6B-11A	4065	2399	B10HS	4175	5044	BR8EIX
3476	94167	DIFR6D13	4067	6692	BR10HIX	4176	4832	BR10ES
3479	93815	SILZKR6B10E	4070	6801	BR10EIX	4177	2887	DPR5EA-9
3482	6376	LFR5A-11	4078	6512	D6HA	4179	6801	BR10EIX
3483	95710	DILZKR7B11GS	4082	7803	DPR7EIX-9	4183	3725	BPR8HS
3492	91578	DILKAR7G11GS	4084	2842	PUR7A	4184	7823	BPR4HS
3499	4912	ILKAR7B11	4085	5629	DP7EA-9	4187	6264	CR10E
3500	96509	ILZKAR7E11S	4086	5129	DPR7EA-9	4188	3725	BPR8HS
3501	95770	ILZKBR7B8DG	4087	7803	DPR7EIX-9	4189	4218	CR8EIX
3502	95112	ILZKAR8H8S	4089	5686	DR7EIX	4190	2887	DPR5EA-9
3521	3521	CR9EIX	4090	7912	D7EA	4191	3521	CR9EIX
3690	3690	TR7IX	4093	5829	DP8EA-9	4192	6222	BPR5HS
3780	7938	BKR5E	4094	2202	DPR8EIX-9	4196	7471	C8E
3797	3797	CR8EHIX-9	4096	4929	DPR8EA-9	4197	7669	CR8HIX
3903	3903	BPR6EIX-11	4097	2202	DPR8EIX-9	4198	3035	BR8ECM
3981	3981	BR9EIX	4099	2120	D8EA	4199	7502	CR9EH-9
4000	7840	CR5HSA	4100	6681	DR8EIX	4200	4085	BPR6HIX
4002	3228	C6HSA	4101	2923	DR8ES-L	4201	7546	CR7EK
4003	7544	CR7HIX	4103	7112	D8HA	4203	6216	CR9EHIX-9

**NOTE:** Cross references are provided as a GUIDE ONLY. Due to differences in design / materials, products produced by various mfrs may have different specifications. Please refer to specific application guide for proper usage.

**REMARQUE:** Les références sont fournies en GUIDE UNIQUEMENT. En raison des différences de conception et de matériaux, des produits fabriqués par différents fabricants peuvent avoir des spécifications différentes. Veuillez vous référer au guide d'application spécifique pour l'utilisation correcte.



Competitor #	NGK Stock #	NGK Part #	Competitor #	NGK Stock #	NGK Part #	Competitor #	NGK Stock #	NGK Part #
DENSO			DENSO			DENSO		
4205	5944	BPR7HIX	4504	4639	PFR6L-11	4511	90813	TR5AI-13
4208	2170	J9A	4504	4793	PFR6G	4511	93858	TR5BP12
4209	5629	DP7EA-9	4504	4867	IFR6B-K	4511	97287	ITR5H13
4210	5829	DP8EA-9	4504	5266	IZFR6K-11S	4512	5141	TR6GP
4212	3486	CR7EH-9	4504	5344	IFR6D10	4512	5809	TR6AP-13
4215	7669	CR8HIX	4504	5368	IFR6B11	4512	90156	ITR6G9
4218	4218	CR8EIX	4504	5547	PFR6W-TG	4513	2467	PTR5A-13
4221	6965	CR6E	4504	5555	PFR6G-11	4513	3474	ILTR5B11
4228	6899	CPR6EA-9	4504	5648	IFR6Q-G	4513	5019	LTR5GP
4501	3573	PGR5A-11	4504	5874	PFR6U-11G	4513	5476	ILTR5D
4501	3971	BPR5EP-11	4504	6507	IFR6B	4513	5581	ILTR5C11
4501	5760	PGR5C-11	4504	6741	IFR6E11	4513	90083	LTR5BI-13
4501	7082	BPR5EGP	4504	6994	IZFR6K11	4513	90607	ILTR5K13
4502	4984	PGR6A	4504	7092	BKR6EGP	4513	90882	ILTR5M9G
4502	7082	BPR5EGP	4504	7658	IFR6J11	4513	91418	ILTR5E11
4502	7084	BPR6EGP	4504	92085	IFR6V-10G	4513	96329	ILTR5L11
4503	1311	DIFR5C11	4505	1637	ILFR5B11	4701	1311	DIFR5C11
4503	1313	FR5EI	4505	5018	LFR5AGP	4701	1313	FR5EI
4503	2271	PFR5C-11	4505	6240	PLFR5A-11	4701	1675	PFR7S8EG
4503	2300	PFR5B-11	4505	92605	DILFR5E11	4701	2271	PFR5C-11
4503	2647	PFR5G-11	4505	93298	LZFR5BI-11	4701	2300	PFR5B-11
4503	2761	PFR5G-13E	4505	93759	DILFR5A11	4701	2477	ZFR5FIX-11
4503	2890	BKR5EKUP	4505	96779	ILFR5T11	4701	2647	PFR5G-11
4503	3107	IFR5G-11K	4505	97606	PLZFR5B13EG	4701	2761	PFR5G-13E
4503	3440	BKR5EP-11	4505	98376	DILFR5A-11D	4701	2890	BKR5EKUP
4503	3508	IFR5T-8N	4506	373	SILFR6B8	4701	3107	IFR5G-11K
4503	3657	IZFR5K11	4506	1208	ILZFR6D11	4701	3440	BKR5EP-11
4503	3741	PZFR5F	4506	1483	LFR6CGP	4701	3508	IFR5T-8N
4503	4292	PFR5R-11	4506	1959	PLFR6C-10G	4701	3657	IZFR5K11
4503	4302	BKR5EKP-11	4506	3588	ILFR6A	4701	3741	PZFR5F
4503	4363	PZFR5F-11	4506	4458	ILFR6J-11K	4701	4292	PFR5R-11
4503	4642	PFR5J-11	4506	4904	ILFR6T11	4701	4302	BKR5EKP-11
4503	4696	IFR5D10	4506	5468	SILFR6A11	4701	4363	PZFR5F-11
4503	4996	IFR5T11	4506	5987	PLZFR6A-11S	4701	4642	PFR5J-11
4503	5459	PFR5L-11	4506	6176	DILFR6D11	4701	4696	IFR5D10
4503	5463	FR5AP-11	4506	6481	ILFR6B	4701	4996	IFR5T11
4503	5838	PFR5N-11	4506	7505	SILFR6C11	4701	5459	PFR5L-11
4503	6371	FR5AP-10	4506	7913	SILFR6A	4701	5463	FR5AP-11
4503	6569	FR5AP-11E	4506	92491	DILFR6J11	4701	5464	BKR5EIX-11
4503	7090	BKR5EGP	4506	95712	LZFR6AP11GS	4701	5838	PFR5N-11
4503	7098	ZFR5FGP	4507	2097	BCPR5EP-11	4701	6341	BKR5EIX
4503	7418	IFR5J11	4507	2950	BCPR5EP-8	4701	6371	FR5AP-10
4503	7854	IFR5G11	4507	7086	BCPR5EGP	4701	6441	ZFR6FIX-11
4503	7866	IFR5N10	4507	7090	BKR5EGP	4701	6569	FR5AP-11E
4503	7968	PZFR5D-11	4508	3350	BCPR6EP-11	4701	7090	BKR5EGP
4503	7994	IFR5E11	4508	4045	PFR6A-11	4701	7418	IFR5J11
4503	92041	ZFR5AP	4508	4497	BCPR6EP-N-11	4701	7854	IFR5G11
4504	127	SIFR6A11	4508	5275	BCPR6EP-N-8	4701	7866	IFR5N10
4504	1312	DIFR6C11	4508	6290	PFR6H-10	4701	7968	PZFR5D-11
4504	2215	BKR6EP-8	4508	7088	BCPR6EGP	4701	7994	IFR5E11
4504	2341	PFR6G-13E	4509	2953	YR5GP	4701	92041	ZFR5AP
4504	2380	PFR7G-11	4509	3207	UR45GP	4701	94460	PFR8S8EG
4504	2687	FR6EI	4509	3547	UR5GP	4702	127	SIFR6A11
4504	2743	PFR6J-11	4510	3547	UR5GP	4702	1312	DIFR6C11
4504	2978	BKR6EP-11	4511	1209	PTR4G-15	4702	2215	BKR6EP-8
4504	3141	PFR6L-13	4511	1465	IZTR5B11	4702	2341	PFR6G-13E
4504	3199	BKR6EQUP	4511	3186	TR5GP	4702	2380	PFR7G-11
4504	3452	BKR6EKP-11	4511	3403	TR55GP	4702	2687	FR6EI
4504	3500	PFR6B	4511	3784	PTR5D-10	4702	2743	PFR6J-11
4504	3546	PFR6N-11	4511	4213	IZTR4A11	4702	2978	BKR6EP-11
4504	3586	PZFR6J-11	4511	5599	ITR4A15	4702	3141	PFR6L-13
4504	4014	PFR6B-11	4511	6579	PTR5F-11	4702	3199	BKR6EQUP
4504	4115	PFR6G-13	4511	7740	PTR5C-13	4702	3452	BKR6EKP-11
4504	4589	IFR6T11	4511	7862	PZTR5A-15	4702	3500	PFR6B

NOTE: Cross references are provided as a GUIDE ONLY. Due to differences in design / materials, products produced by various mfrs may have different specifications. Please refer to specific application guide for proper usage.

434 NOTA: El cruce de referencias servirá únicamente como guía. Las diferencias en diseño, materiales y los productos utilizados para su elaboración pueden variar dependiendo del fabricante. Para obtener la aplicación correcta de su vehículo, por favor referirse a la sección correspondiente dentro de esta guía.



Competitor #	NGK Stock #	NGK Part #	Competitor #	NGK Stock #	NGK Part #	Competitor #	NGK Stock #	NGK Part #
DENSO			DENSO			DENSO		
4702	3546	PFR6N-11	4708	3573	PGR5A-11	4719	94806	LTR6BP13
4702	3586	PZFR6J-11	4708	3971	BPR5EP-11	4719	95369	SILTR6A7G
4702	3764	BKR6EIX-11	4708	5760	PGR5C-11	4719	95853	LTR6AI13
4702	4014	PFR6B-11	4708	7082	BPR5EGP	4719	96588	LTR6DI-8
4702	4115	PFR6G-13	4709	3903	BPR6EIX-11	4719	96621	ILTR6G8G
4702	4589	IFR6T11	4709	4984	PGR6A	4719	96870	ILTR6H8G
4702	4639	PFR6L-11	4709	6597	BPR5EIX	4719	97177	LTR6CI-8
4702	4793	PFR6G	4709	6637	BPR6EIX	4772	4772	DR9EIX
4702	4867	IFR6B-K	4709	7084	BPR6EGP	5002	2910	AB-6
4702	5266	IZFR6K-11S	4710	9029	DILKAR6A11	5003	3010	AB-7
4702	5344	IFR6D10	4711	9029	DILKAR6A11	5004	7909	AB-8
4702	5368	IFR6B11	4711	94124	ILKAR7L11	5006	2438	WR5
4702	5547	PFR6W-TG	4712	1406	DILKAR7B11	5007	2438	WR5
4702	5555	PFR6G-11	4712	6043	ILZKAR7A10	5008	2438	WR5
4702	5648	IFR6Q-G	4712	90137	DILZKAR7C11S	5009	2438	WR5
4702	5874	PFR6U-11G	4712	90935	DILZKAR7B11	5010	2438	WR5
4702	6418	BKR6EIX	4712	91578	DILKAR7G11GS	5012	3323	AR6FS
4702	6507	IFR6B	4712	93482	SILZKAR7B11	5013	3323	AR6FS
4702	6741	IFR6E11	4712	96509	ILZKAR7E11S	5014	3323	AR6FS
4702	6994	IZFR6K11	4713	1209	PTR4G-15	5015	3323	AR6FS
4702	7092	BKR6EGP	4713	1465	IZTR5B11	5016	1273	BCPR5E-11
4702	7658	IFR6J11	4713	3186	TR5GP	5016	2441	BCPR5EY-11
4702	92085	IFR6V-10G	4713	3784	PTR5D-10	5017	3686	FR45
4703	1637	ILFR5B11	4713	4213	IZTR4A11	5018	7252	FR5-1
4703	4469	LFR5AIX-11	4713	5599	ITR4A15	5020	6630	UR4
4703	5018	LFR5AGP	4713	6579	PTR5F-11	5021	6945	UR45
4703	6240	PLFR5A-11	4713	7164	TR55IX	5022	7300	TR4IX
4703	92605	DILFR5E11	4713	7397	TR5IX	5023	3951	TR55
4703	93298	LZFR5BI-11	4713	7740	PTR5C-13	5024	6630	UR4
4703	93759	DILFR5A11	4713	7862	PZTR5A-15	5025	6630	UR4
4703	96779	ILFR5T11	4713	90813	TR5AI-13	5026	6630	UR4
4703	97606	PLZFR5B13EG	4713	93858	TR5BP12	5027	6945	UR45
4703	98376	DILFR5A-11D	4713	97287	ITR5H13	5028	6945	UR45
4704	373	SILFR6B8	4714	3689	TR6IX	5029	7052	YR5
4704	1208	ILZFR6D11	4714	5141	TR6GP	5030	7516	YR5IX
4704	1483	LFR6CGP	4714	5809	TR6AP-13	5031	7300	TR4IX
4704	1959	PLFR6C-10G	4714	6509	LTR6IX-11	5032	2238	TR5
4704	3588	ILFR6A	4714	90156	ITR6G9	5032	3623	BPR6EFS
4704	4458	ILFR6J-11K	4715	3547	UR5GP	5032	7300	TR4IX
4704	4904	ILFR6T11	4715	7559	UR45IX	5033	3951	TR55
4704	5468	SILFR6A11	4716	7177	UR5IX	5036	7773	UR6
4704	5987	PLZFR6A-11S	4716	7966	UR6GP	5037	7773	UR6
4704	6176	DILFR6D11	4717	2314	LZTR5AIX-13	5043	4536	XR45
4704	6481	ILFR6B	4717	3381	LZTR5AGP	5044	3522	BR6S
4704	6619	LFR6AIX-11	4717	4998	PLZTR5A-13	5046	3522	BR6S
4704	7505	SILFR6C11	4718	2467	PTR5A-13	5047	2238	TR5
4704	7913	SILFR6A	4718	3474	ILTR5B11	5048	4177	TR6
4704	92491	DILFR6J11	4718	4344	LTR5IX-11	5060	4563	BCP6ET
4704	95712	LZFR6AP11GS	4718	5019	LTR5GP	5061	2397	BKUR6ET-10
4705	6858	DFH6B-11A	4718	5476	ILTR5D	5061	7808	BKUR6ET
4706	2097	BCPR5EP-11	4718	5581	ILTR5C11	5062	5509	BCPR7ET
4706	2950	BCPR5EP-8	4718	90083	LTR5BI-13	5063	2288	BKR6EK
4706	3306	BCPR5EIX-11	4718	90607	ILTR5K13	5065	1263	BP6ET
4706	5688	BCPR5EIX	4718	90882	ILTR5M9G	5066	5877	BR7ET
4706	7086	BCPR5EGP	4718	91418	ILTR5E11	5067	7517	BUR6ET
4707	3350	BCPR6EP-11	4718	96329	ILTR5L11	5068	2467	PTR5A-13
4707	4045	PFR6A-11	4719	3587	PLTR6A-10G	5069	5496	BKUR7ET
4707	4497	BCPR6EP-N-11	4719	3787	ILTR6A-8G	5070	7740	PTR5C-13
4707	4919	BCPR6EIX-11	4719	6509	LTR6IX-11	5077	7862	PZTR5A-15
4707	5275	BCPR6EP-N-8	4719	90117	ILTR6E11	5087	97287	ITR5H13
4707	5689	BCPR6EIX	4719	90656	ILTR6F9	5088	2910	AB-6
4707	6290	PFR6H-10	4719	91725	LTR6BI-13	5090	7397	TR5IX
4707	7088	BCPR6EGP	4719	92182	LTR6BI-9	5091	93858	TR5BP12
4708	2115	BPR5EIX-11	4719	94489	ILTR6M9G	5092	5809	TR6AP-13

**NOTE:** Cross references are provided as a GUIDE ONLY. Due to differences in design / materials, products produced by various mfrs may have different specifications. Please refer to specific application guide for proper usage.

**REMARQUE:** Les références sont fournies en GUIDE UNIQUEMENT. En raison des différences de conception et de matériaux, des produits fabriqués par différents fabricants peuvent avoir des spécifications différentes. Veuillez vous référer au guide d'application spécifique pour l'utilisation correcte.



Competitor #	NGK Stock #	NGK Part #	Competitor #	NGK Stock #	NGK Part #	Competitor #	NGK Stock #	NGK Part #
DENSO			DENSO			DENSO		
5301	3306	BCPR5EIX-11	5379	7067	BR7HIX	6060	4322	BR8HS
5301	5688	BCPR5EIX	5380	7001	BR8HIX	6076	6376	LFR5A-11
5302	4919	BCPR6EIX-11	5381	5687	BR9HIX	6216	6216	CR9EHIX-9
5302	5689	BCPR6EIX	5383	7544	CR7HIX	6681	6681	DR8EIX
5303	2477	ZFR5FIX-11	5384	7669	CR8HIX	6901	3981	BR9EIX
5303	5464	BKR5EIX-11	5388	6966	IMR9A-9H	6904	6801	BR10EIX
5303	6341	BKR5EIX	5390	6289	CR9EIA-9	6905	6801	BR10EIX
5304	3764	BKR6EIX-11	5391	3520	BR8ECMIX	6988	6988	BKR7EIX-11
5304	6418	BKR6EIX	5392	2707	BR9ECMIX	7177	7177	UR5IX
5305	2115	BPR5EIX-11	5393	3006	BR10ECMIX	7214	7214	GR5IX
5305	6597	BPR5EIX	5394	7803	DPR7EIX-9	7272	7272	UR55IX
5306	6637	BPR6EIX	5501	6418	BKR6EIX	7348	7348	UR6IX
5307	4055	BPR7EIX	5502	6637	BPR6EIX	7385	7385	CR7EIX
5308	6046	DCPR7EIX	5545	5545	DPR9EIX-9	7478	3006	BR10ECMIX
5309	6546	DCPR8EIX	5601	3306	BCPR5EIX-11	7544	7544	CR7HIX
5310	2667	BKR7EIX	5602	4919	BCPR6EIX-11	7669	7669	CR8HIX
5313	5690	BCPR7EIX	5603	5464	BKR5EIX-11	7803	7803	DPR7EIX-9
5313	5691	BCPR7EIX-11	5604	3764	BKR6EIX-11	067100-1330	7493	Y-147T
5316	5044	BR8EIX	5604	4294	IZFR6H11	067100-1370	2187	Y-118R
5316	6747	BR8EIX SOLID	5608	6046	DCPR7EIX	067100-1430	7492	Y-146R
5317	3981	BR9EIX	5614	7901	IJR7A9	067100-1460	2188	Y-197R
5318	6801	BR10EIX	5615	6994	IZFR6K11	067100-1690	3782	Y-703R
5319	6801	BR10EIX	5616	5068	IFR8H11	DG-001	1250	Y-208T
5319	6957	BR10EIX SOLID	5617	4469	LFR5AIX-11	DG-001	3473	Y-924J
5323	4897	R7435-10	5618	1208	ILZFR6D11	DG-002	1239	Y-207T
5325	7397	TR5IX	5618	6619	LFR6AIX-11	DG-002	3704	Y-918J
5326	3689	TR6IX	5619	2309	LFR7AIX	DG-002	3829	Y-204TS1
5327	3690	TR7IX	5626	3653	IMR8C-9H	DG-005	5909	Y-732J
5330	7177	UR5IX	5627	6777	IMR9C-9H	DG-215	2187	Y-118R
5336	4709	FR9BI-11	5628	3657	IZFR5K11	DG-216	3782	Y-703R
5337	2316	DCPR9EIX	5629	5114	IFR7L11	DG-222	2188	Y-197R
5338	4344	LTR5IX-11	5630	6588	IFR9H11	DG-223	7492	Y-146R
5339	6509	LTR6IX-11	5631	4888	IMR9B-9H	DG-232	7493	Y-147T
5340	6510	LTR7IX-11	5633	3521	CR9EIX	DK20PR-D13	94167	DIFR6D13
5341	4344	LTR5IX-11	5642	5766	IMR9C-9HES	DXE22HCR11	96509	ILZKAR7E11S
5343	4469	LFR5AIX-11	5686	5686	DR7EIX	DXE22HQR-D11S	91578	DILKAR7G11GS
5344	6619	LFR6AIX-11	5687	5687	BR9HIX	DXU22HCR-D11S	95710	DILZKR7B11GS
5345	2309	LFR7AIX	5701	5068	IFR8H11	FK16HQR11	98376	DILFR5A-11D
5348	7746	IFR7G-11KS	5702	4709	FR9BI-11	FK16HR-11	93759	DILFR5A11
5349	2314	LZTR5AIX-13	5709	4897	R7435-10	FK20HBR11	6858	DFH6B-11A
5352	5266	IZFR6K-11S	5713	5442	R7376-8	FK20HR11	6176	DILFR6D11
5353	93911	LKR7AIX	5715	6957	BR10EIX SOLID	FXE20HE11	9029	DILKAR6A11
5354	93815	SILZKR6B10E	5716	6801	BR10EIX	FXE20HR11	9029	DILKAR6A11
5356	93911	LKR7AIX	5717	2741	R6252K-105	FXE22HR11	1406	DILKAR7B11
5357	6441	ZFR6FIX-11	5728	2396	R6252E-105	FXE24HR11	96024	ILKAR8H6
5358	6441	ZFR6FIX-11	5732	5281	R2525-10	IFT16	7177	UR5IX
5359	3419	BR6HIX	5739	4216	R0045Q-10	IHU27	6777	IMR9C-9H
5360	6965	CR6E	5752	6701	RE9B-T	IK01-24	5068	IFR8H11
5361	7385	CR7EIX	5754	6700	RE7C-L	IK01-27	4709	FR9BI-11
5362	4218	CR8EIX	6005	2264	BPR2ES	IK16	2477	ZFR5FIX-11
5363	4772	DR9EIX	6008	3210	B-4	IK16	5464	BKR5EIX-11
5364	6482	CR10EIX	6013	3112	B-4L	IK16	6341	BKR5EIX
5365	4218	CR8EIX	6020	5858	XR4	IK16L	6441	ZFR6FIX-11
5366	3521	CR9EIX	6021	5858	XR4	IK16TT	1311	DIFR5C11
5367	6482	CR10EIX	6027	7321	BPM7A	IK16TT	1313	FR5EI
5368	3797	CR8EHIX-9	6033	3210	B-4	IK16TT	1675	PFR7S8EG
5369	6777	IMR9C-9H	6044	2264	BPR2ES	IK16TT	2271	PFR5C-11
5371	5686	DR7EIX	6046	2264	BPR2ES	IK16TT	2300	PFR5B-11
5372	6681	DR8EIX	6047	5126	B8HS-10	IK16TT	2477	ZFR5FIX-11
5373	4772	DR9EIX	6049	7321	BPM7A	IK16TT	2647	PFR5G-11
5375	7803	DPR7EIX-9	6051	4122	BR7HS	IK16TT	2761	PFR5G-13E
5376	2202	DPR8EIX-9	6053	3922	BR6HS	IK16TT	2890	BKR5EKUP
5377	5545	DPR9EIX-9	6054	7534	B6HS	IK16TT	3107	IFR5G-11K
5378	3419	BR6HIX	6058	3725	BPR8HS			

NOTE: Cross references are provided as a GUIDE ONLY. Due to differences in design / materials, products produced by various mfrs may have different specifications. Please refer to specific application guide for proper usage.

436 NOTA: El cruce de referencias servirá únicamente como guía. Las diferencias en diseño, materiales y los productos utilizados para su elaboración pueden variar dependiendo del fabricante. Para obtener la aplicación correcta de su vehículo, por favor referirse a la sección correspondiente dentro de esta guía.



Competitor #	NGK Stock #	NGK Part #	Competitor #	NGK Stock #	NGK Part #	Competitor #	NGK Stock #	NGK Part #
DENSO			DENSO			DENSO		
IK16TT	3440	BKR5EP-11	IK20TT	92085	IFR6V-10G	IT16TT	5599	ITR4A15
IK16TT	3508	IFR5T-8N	IK22	2667	BKR7EIX	IT16TT	6579	PTR5F-11
IK16TT	3657	IZFR5K11	IK22	6988	BKR7EIX-11	IT16TT	7164	TR55IX
IK16TT	3741	PZFR5F	IK22G	7746	IFR7G-11KS	IT16TT	7397	TR5IX
IK16TT	4292	PFR5R-11	IK27C11	4709	FR9B1-11	IT16TT	7740	PTR5C-13
IK16TT	4302	BKR5EKP-11	IKBH20TT	6858	DFH6B-11A	IT16TT	7862	PZTR5A-15
IK16TT	4363	PZFR5F-11	IKH16	4469	LF5AIX-11	IT16TT	90813	TR5AI-13
IK16TT	4642	PFR5J-11	IKH16TT	1637	ILFR5B11	IT16TT	93858	TR5BP12
IK16TT	4696	IFR5D10	IKH16TT	4469	LF5AIX-11	IT16TT	97287	ITR5H13
IK16TT	4996	IFR5T11	IKH16TT	5018	LF5AGP	IT20	3689	TR6IX
IK16TT	5459	PFR5L-11	IKH16TT	6240	PLFR5A-11	IT20TT	3689	TR6IX
IK16TT	5463	FR5AP-11	IKH16TT	92605	DILFR5E11	IT20TT	5141	TR6GP
IK16TT	5464	BKR5EIX-11	IKH16TT	93298	LZFR5B1-11	IT20TT	5809	TR6AP-13
IK16TT	5838	PFR5N-11	IKH16TT	93759	DILFR5A11	IT20TT	6509	LTR6IX-11
IK16TT	6341	BKR5EIX	IKH16TT	96779	ILFR5T11	IT20TT	90156	ITR6G9
IK16TT	6371	FR5AP-10	IKH16TT	97606	PLZFR5B13EG	IT22	3690	TR7IX
IK16TT	6441	ZFR6FIX-11	IKH16TT	98376	DILFR5A-11D	ITF16	7177	UR5IX
IK16TT	6569	FR5AP-11E	IKH20	6619	LF6AIX-11	ITF16	7272	UR55IX
IK16TT	7090	BKR5EGP	IKH20TT	373	SILFR6B8	ITF16TT	3547	UR5GP
IK16TT	7418	IFR5J11	IKH20TT	1208	ILZFR6D11	ITF16TT	7559	UR45IX
IK16TT	7854	IFR5G11	IKH20TT	1483	LF6CGP	ITF20	7348	UR6IX
IK16TT	7866	IFR5N10	IKH20TT	1959	PLFR6C-10G	ITF20TT	7177	UR5IX
IK16TT	7968	PZFR5D-11	IKH20TT	3588	ILFR6A	ITF20TT	7966	UR6GP
IK16TT	7994	IFR5E11	IKH20TT	4458	ILFR6J-11K	ITL16	2314	LZTR5AIX-13
IK16TT	92041	ZFR5AP	IKH20TT	4904	ILFR6T11	ITL16TT	2314	LZTR5AIX-13
IK16TT	94460	PFR8S8EG	IKH20TT	5468	SILFR6A11	ITL16TT	3381	LZTR5AGP
IK20	3764	BKR6EIX-11	IKH20TT	5987	PLZFR6A-11S	ITL16TT	4998	PLZTR5A-13
IK20	6418	BKR6EIX	IKH20TT	6176	DILFR6D11	ITV16	4344	LTR5IX-11
IK20G	5266	IZFR6K-11S	IKH20TT	6481	ILFR6B	ITV16TT	2467	PTR5A-13
IK20L	6441	ZFR6FIX-11	IKH20TT	6619	LF6AIX-11	ITV16TT	3474	ILTR5B11
IK20TT	127	SIFR6A11	IKH20TT	7505	SILFR6C11	ITV16TT	4344	LTR5IX-11
IK20TT	1312	DIFR6C11	IKH20TT	7913	SILFR6A	ITV16TT	5019	LTR5GP
IK20TT	2215	BKR6EP-8	IKH20TT	92491	DILFR6J11	ITV16TT	5476	ILTR5D
IK20TT	2341	PFR6G-13E	IKH20TT	95712	LZFR6AP11GS	ITV16TT	5581	ILTR5C11
IK20TT	2380	PFR7G-11	IKH22	2309	LF7AIX	ITV16TT	90083	LTR5BI-13
IK20TT	2687	FR6EI	IQ01-31	4897	R7435-10	ITV16TT	90607	ILTR5K13
IK20TT	2743	PFR6J-11	IQ16	3306	BCPR5EIX-11	ITV16TT	90882	ILTR5M9G
IK20TT	2978	BKR6EP-11	IQ16	5688	BCPR5EIX	ITV16TT	91418	ILTR5E11
IK20TT	3141	PFR6L-13	IQ16TT	2097	BCPR5EP-11	ITV16TT	96329	ILTR5L11
IK20TT	3199	BKR6EQUP	IQ16TT	2950	BCPR5EP-8	ITV20	6509	LTR6IX-11
IK20TT	3452	BKR6EKP-11	IQ16TT	3306	BCPR5EIX-11	ITV20TT	3587	PLTR6A-10G
IK20TT	3500	PFR6B	IQ16TT	5688	BCPR5EIX	ITV20TT	6509	LTR6IX-11
IK20TT	3546	PFR6N-11	IQ16TT	7086	BCPR5EGP	ITV20TT	90117	ILTR6E11
IK20TT	3586	PZFR6J-11	IQ20	4919	BCPR6EIX-11	ITV20TT	92182	LTR6BI-9
IK20TT	3764	BKR6EIX-11	IQ20	5689	BCPR6EIX	ITV20TT	94806	LTR6BP13
IK20TT	4014	PFR6B-11	IQ20TT	3350	BCPR6EP-11	ITV20TT	95369	SILTR6A7G
IK20TT	4115	PFR6G-13	IQ20TT	4045	PFR6A-11	ITV20TT	95853	LTR6AI13
IK20TT	4589	IFR6T11	IQ20TT	4497	BCPR6EP-N-11	ITV20TT	96588	LTR6DI-8
IK20TT	4639	PFR6L-11	IQ20TT	4919	BCPR6EIX-11	ITV20TT	97177	LTR6CI-8
IK20TT	4793	PFR6G	IQ20TT	5275	BCPR6EP-N-8	ITV22	6510	LTR7IX-11
IK20TT	4867	IFR6B-K	IQ20TT	5689	BCPR6EIX	ITV24	4344	LTR5IX-11
IK20TT	5266	IZFR6K-11S	IQ20TT	6290	PFR6H-10	IU20	6965	CR6E
IK20TT	5344	IFR6D10	IQ20TT	7088	BCPR6EGP	IU22	7385	CR7EIX
IK20TT	5368	IFR6B11	IQ22	5690	BCPR7EIX	IU24	4218	CR8EIX
IK20TT	5547	PFR6W-TG	IQ22	5691	BCPR7EIX-11	IU24A	4218	CR8EIX
IK20TT	5555	PFR6G-11	IQ31	4897	R7435-10	IU27	3521	CR9EIX
IK20TT	5648	IFR6Q-G	IRL01-27	6700	RE7C-L	IU27	4772	DR9EIX
IK20TT	5874	PFR6U-11G	IRT01-31	6701	RE9B-T	IU27A	3521	CR9EIX
IK20TT	6418	BKR6EIX	IT16	7397	TR5IX	IU27D	6289	CR9EIA-9
IK20TT	6507	IFR6B	IT16TT	1209	PTR4G-15	IU31	6482	CR10EIX
IK20TT	6741	IFR6E11	IT16TT	1465	IZTR5B11	IU31A	6482	CR10EIX
IK20TT	6994	IZFR6K11	IT16TT	3186	TR5GP	IUF22	7544	CR7HIX
IK20TT	7092	BKR6EGP	IT16TT	3784	PTR5D-10	IUF24	7669	CR8HIX
IK20TT	7658	IFR6J11	IT16TT	4213	IZTR4A11	IUH24	3797	CR8EHIX-9

**NOTE:** Cross references are provided as a GUIDE ONLY. Due to differences in design / materials, products produced by various mfrs may have different specifications. Please refer to specific application guide for proper usage.

**REMARQUE:** Les références sont fournies en GUIDE UNIQUEMENT. En raison des différences de conception et de matériaux, des produits fabriqués par différents fabricants peuvent avoir des spécifications différentes. Veuillez vous référer au guide d'application spécifique pour l'utilisation correcte.





Competitor #	NGK Stock #	NGK Part #	Competitor #	NGK Stock #	NGK Part #	Competitor #	NGK Stock #	NGK Part #
DENSO			DENSO			DENSO		
IUH24	7669	CR8HIX	IXU22	6046	DCPR7EIX	K22P-U11	5791	BKR7E-11
IUH27	6216	CR9EHIX-9	IXU22C	6046	DCPR7EIX	K22TMR	2095	BKR7EKC-N
IUH27D	6966	IMR9A-9H	IXU24	6546	DCPR8EIX	KJ14CR11	4043	ZFR4F-11
IVT20TT	3787	ILTR6A-8G	IXU27	2316	DCPR9EIX	KJ14CR-L11	4043	ZFR4F-11
IVT20TT	6509	LTR6IX-11	IXUH20I	93815	SILZKR6B10E	KJ16CR	7558	ZFR5F
IVT20TT	90656	ILTR6F9	IXUH22	93911	LKR7AIX	KJ16CR11	4435	ZFR5E-11
IVT20TT	91725	LTR6BI-13	IXUH22I	93911	LKR7AIX	KJ16CR11	5584	ZFR5J-11
IVT20TT	94489	ILTR6M9G	J16AY	6937	BPR5EY-11	KJ16CR-11	2262	ZFR5F-11
IVT20TT	96621	ILTR6G8G	J16BR-U	6334	ZGR5C	KJ16CR-L11	2262	ZFR5F-11
IVT20TT	96870	ILTR6H8G	J16BR-U11	6334	ZGR5C	KJ16CR-L11	5584	ZFR5J-11
IW01-24	5442	R7376-8	J16CR-U	5077	ZGR5A	KJ16CR-U11	2262	ZFR5F-11
IW01-29	6957	BR10EIX SOLID	J16C-U	5077	ZGR5A	KJ20CR11	2262	ZFR5F-11
IW01-31	6801	BR10EIX	J16HR-U10	6334	ZGR5C	KJ20CR-11	4291	ZFR6F-11
IW01-32	2741	R6252K-105	K14PR-U11	5424	BKR4E-11	KJ20CR-U11	4291	ZFR6F-11
IW16	2115	BPR5EIX-11	K16GPR-U11	4435	ZFR5E-11	KJ20DR-M11	2756	BKR6E-11
IW16	6597	BPR5EIX	K16GPR-U11	4936	ZFR5D-11	KJ22CR11	6855	ZFR7F-11
IW16	7214	GR5IX	K16HPR-U11	6376	LFRA5A-11	KJ22CR-L11	6855	ZFR7F-11
IW16TT	2115	BPR5EIX-11	K16HR-U11	6376	LFRA5A-11	LP20R-U	6427	BPR6EY
IW16TT	3573	PGR5A-11	K16PR-L11	2391	BKR5E-N-11	M17	2910	AB-6
IW16TT	3971	BPR5EP-11	K16PR-P11	6371	FR5AP-10	M22	3010	AB-7
IW16TT	5760	PGR5C-11	K16PR-TP11	5464	BKR5EIX-11	M24S	7909	AB-8
IW16TT	7082	BPR5EGP	K16PR-U	7938	BKR5E	MA9PR-U	2438	WR5
IW20	3903	BPR6EIX-11	K16PR-U11	6953	BKR5E-11	MA16PR-U	2438	WR5
IW20	6637	BPR6EIX	K16PR-ZU11	5464	BKR5EIX-11	MA16PR-U11	2438	WR5
IW20TT	3903	BPR6EIX-11	K16PSRB8	1313	FR5EI	MA16PR-U15	2438	WR5
IW20TT	4984	PGR6A	K16P-U	7938	BKR5E	MA16P-U	2438	WR5
IW20TT	6597	BPR5EIX	K16P-U11	6953	BKR5E-11	MA20PR-U	3323	AR6FS
IW20TT	6637	BPR6EIX	K16R-U	2087	BKR5EYA	MA20P-U	3323	AR6FS
IW20TT	7084	BPR6EGP	K16R-U11	2526	BKR5EYA-11	MA20R-U	3323	AR6FS
IW22	4055	BPR7EIX	K16R-ZU11	5464	BKR5EIX-11	MA20R-U11	3323	AR6FS
IW24	5044	BR8EIX	K16TNR-S9	7797	BKR5EK	MW17	2910	AB-6
IW24	6747	BR8EIX SOLID	K16TR11	3967	BKR5EKB-11	MW22	3010	AB-7
IW27	3089	BR9EIX SOLID	K16-U	2087	BKR5EYA	P16PR8	3573	PGR5A-11
IW27	3981	BR9EIX	K16-U11	2526	BKR5EYA-11	P16PR11	3573	PGR5A-11
IW29	6801	BR10EIX	K20HR-U11	7787	LFRA6C-11	P16R	3971	BPR5EP-11
IW31	6801	BR10EIX	K20PBR	4563	BCP6ET	P16R13	3573	PGR5A-11
IW31	6957	BR10EIX SOLID	K20PBR-S10	2397	BKUR6ET-10	P20PR8	4984	PGR6A
IWF16	3419	BR6HIX	K20PBR-S10	7808	BKUR6ET	P20PR11	7084	BPR6EGP
IWF20	3419	BR6HIX	K20PR-TP11	3764	BKR6EIX-11	P20PR-S11	6637	BPR6EIX
IWF22	7067	BR7HIX	K20PR-U	6962	BKR6E	P20R8	7084	BPR6EGP
IWF24	7001	BR8HIX	K20PR-U11	2756	BKR6E-11	P20R11	7084	BPR6EGP
IWF27	5687	BR9HIX	K20PR-ZU11	3764	BKR6EIX-11	P22PR8	3200	PGR7A
IWM01-32	2396	R6252E-105	K20PSR-B8	6418	BKR6EIX	PK16PR8	2647	PFR5G-11
IWM24	3520	BR8ECMIX	K20P-U	6962	BKR6E	PK16PR11	2300	PFR5B-11
IWM27	2707	BR9ECMIX	K20P-U11	2756	BKR6E-11	PK16PR-L11	5459	PFR5L-11
IWM31	3006	BR10ECMIX	K20R-U	3696	BKR6EY	PK16PR-P11	4642	PFR5J-11
IX22	5686	DR7EIX	K20R-U11	5553	BKR6ES-11	PK16R8	2300	PFR5B-11
IX22B	7803	DPR7EIX-9	K20R-Z	6418	BKR6EIX	PK16R11	3440	BKR5EP-11
IX24	6681	DR8EIX	K20R-ZU11	3764	BKR6EIX-11	PK16TR11	4302	BKR5EKP-11
IX24B	2202	DPR8EIX-9	K20TNR	4959	BKR6EK	PK16TR-11	4302	BKR5EKP-11
IX27	4772	DR9EIX	K20TNR-S	2288	BKR6EK	PK16TT	1311	DIFR5C11
IX27B	5545	DPR9EIX-9	K20TNR-S9	2288	BKR6EK	PK16TT	1313	FR5EI
IXEH20ETT	9029	DILKAR6A11	K20TR-11	3452	BKR6EKP-11	PK16TT	2271	PFR5C-11
IXEH20TT	9029	DILKAR6A11	K20TXR	2288	BKR6EK	PK16TT	2300	PFR5B-11
IXEH20TT	94124	ILKAR7L11	K20-U	7990	BKR6EYA	PK16TT	2647	PFR5G-11
IXEH22TT	1406	DILKAR7B11	K20-U11	7990	BKR6EYA	PK16TT	2761	PFR5G-13E
IXEH22TT	6043	ILZKAR7A10	K22PB	5496	BKUR7ET	PK16TT	2890	BKR5EKUP
IXEH22TT	90137	DILZKAR7C11S	K22PBR-S	5509	BCPR7ET	PK16TT	3107	IFR5G-11K
IXEH22TT	90935	DILZKAR7B11	K22PR-L11	5791	BKR7E-11	PK16TT	3440	BKR5EP-11
IXEH22TT	91578	DILKAR7G11GS	K22PR-TP11	6988	BKR7EIX-11	PK16TT	3508	IFR5T-8N
IXEH22TT	93482	SILZKAR7B11	K22PR-U	4644	BKR7E	PK16TT	3657	IZFR5K11
IXEH22TT	96509	ILZKAR7E11S	K22PR-U11	5791	BKR7E-11	PK16TT	3741	PZFR5F
IXG24	7803	DPR7EIX-9	K22PR-ZU	2667	BKR7EIX	PK16TT	4292	PFR5R-11
IXU01-31	5281	R2525-10	K22PR-ZU11	6988	BKR7EIX-11	PK16TT	4302	BKR5EKP-11

NOTE: Cross references are provided as a GUIDE ONLY. Due to differences in design / materials, products produced by various mfrs may have different specifications. Please refer to specific application guide for proper usage.

438 NOTA: El cruce de referencias servirá únicamente como guía. Las diferencias en diseño, materiales y los productos utilizados para su elaboración pueden variar dependiendo del fabricante. Para obtener la aplicación correcta de su vehículo, por favor referirse a la sección correspondiente dentro de esta guía.



Competitor #	NGK Stock #	NGK Part #	Competitor #	NGK Stock #	NGK Part #	Competitor #	NGK Stock #	NGK Part #
DENSO			DENSO			DENSO		
PK16TT	4363	PZFR5F-11	PK20TT	92085	IFR6V-10G	PT16TT	5599	ITR4A15
PK16TT	4642	PFR5J-11	PK22PR8	4853	PFR7B	PT16TT	6579	PTR5F-11
PK16TT	4696	IFR5D10	PK22PR11	4853	PFR7B	PT16TT	7740	PTR5C-13
PK16TT	4996	IFR5T11	PK22PR-L11	2380	PFR7G-11	PT16TT	7862	PZTR5A-15
PK16TT	5459	PFR5L-11	PK22PR-L11S	7772	PFR7G-11S	PT16TT	90813	TR5AI-13
PK16TT	5463	FR5AP-11	PKH16TT	1637	ILFR5B11	PT16TT	93858	TR5BP12
PK16TT	5838	PFR5N-11	PKH16TT	5018	LFR5AGP	PT16TT	97287	ITR5H13
PK16TT	6371	FR5AP-10	PKH16TT	6240	PLFR5A-11	PT16VR13	2467	PTR5A-13
PK16TT	6569	FR5AP-11E	PKH16TT	92605	DILFR5E11	PT20TT	5141	TR6GP
PK16TT	7090	BKR5EGP	PKH16TT	93298	LZFR5B1-11	PT20TT	5809	TR6AP-13
PK16TT	7098	ZFR5FGP	PKH16TT	93759	DILFR5A11	PT20TT	90156	ITR6G9
PK16TT	7418	IFR5J11	PKH16TT	96779	ILFR5T11	PT22EPR10	3690	TR7IX
PK16TT	7854	IFR5G11	PKH16TT	97606	PLZFR5B13EG	PTF16TT	2953	YR5GP
PK16TT	7866	IFR5N10	PKH16TT	98376	DILFR5A-11D	PTF16TT	3207	UR45GP
PK16TT	7968	PZFR5D-11	PKH20TT	373	SILFR6B8	PTF16TT	3547	UR5GP
PK16TT	7994	IFR5E11	PKH20TT	1208	ILZFR6D11	PTF20TT	3547	UR5GP
PK16TT	92041	ZFR5AP	PKH20TT	1483	LFR6CGP	PTJ16R15	7862	PZTR5A-15
PK20GR8	6737	PZFR5Q-11	PKH20TT	1959	PLFR6C-10G	PTV16TT	2467	PTR5A-13
PK20PR8	5555	PFR6G-11	PKH20TT	3588	ILFR6A	PTV16TT	3474	ILTR5B11
PK20PR11	4014	PFR6B-11	PKH20TT	4458	ILFR6J-11K	PTV16TT	5019	LTR5GP
PK20PR-L11	3546	PFR6N-11	PKH20TT	4904	ILFR6T11	PTV16TT	5476	ILTR5D
PK20PR-L11	5555	PFR6G-11	PKH20TT	5468	SILFR6A11	PTV16TT	5581	ILTR5C11
PK20PR-L11	6458	PFR6Q	PKH20TT	5987	PLZFR6A-11S	PTV16TT	90083	LTR5B1-13
PK20PR-L13	3141	PFR6L-13	PKH20TT	6176	DILFR6D11	PTV16TT	90607	ILTR5K13
PK20PR-P	2743	PFR6J-11	PKH20TT	6481	ILFR6B	PTV16TT	90882	ILTR5M9G
PK20PR-P8	2743	PFR6J-11	PKH20TT	7505	SILFR6C11	PTV16TT	91418	ILTR5E11
PK20PR-P11	2743	PFR6J-11	PKH20TT	7913	SILFR6A	PTV16TT	96329	ILTR5L11
PK20R8	2215	BKR6EP-8	PKH20TT	92491	DILFR6J11	PW16TT	3573	PGR5A-11
PK20R11	2978	BKR6EP-11	PKH20TT	95712	LZFR6AP11GS	PW16TT	3971	BPR5EP-11
PK20R-13	4115	PFR6G-13	PKJ16CR8	3741	PZFR5F	PW16TT	5760	PGR5C-11
PK20TR11	3452	BKR6EKP-11	PKJ16CR-L11	4363	PZFR5F-11	PW16TT	7082	BPR5EGP
PK20TR-11	3452	BKR6EKP-11	PKJ16CR-L13	4363	PZFR5F-11	PW20TT	4984	PGR6A
PK20TT	127	SIFR6A11	PKJ20CR8	3271	PZFR6F-11	PW20TT	7082	BPR5EGP
PK20TT	1312	DIFR6C11	PKJ20CR-11	3271	PZFR6F-11	PW20TT	7084	BPR6EGP
PK20TT	2215	BKR6EP-8	PKJ20CR-L11	3271	PZFR6F-11	Q16PR-TP11	3306	BCPR5EIX-11
PK20TT	2341	PFR6G-13E	PKJ20CR-M11	3271	PZFR6F-11	Q16PR-U	5155	FR4
PK20TT	2380	PFR7G-11	PQ16R	2097	BCPR5EP-11	Q16PR-U	6130	BCPR5ES
PK20TT	2687	FR6EI	PQ16R8	2097	BCPR5EP-11	Q16PR-U	7938	BKR5E
PK20TT	2743	PFR6J-11	PQ16R13	2097	BCPR5EP-11	Q16PR-U11	2441	BCPR5EY-11
PK20TT	2978	BKR6EP-11	PQ16TT	2097	BCPR5EP-11	Q16PR-U15	3686	FR45
PK20TT	3141	PFR6L-13	PQ16TT	2950	BCPR5EP-8	Q16PR-ZU11	3306	BCPR5EIX-11
PK20TT	3199	BKR6EQUP	PQ16TT	7086	BCPR5EGP	Q16P-U11	1273	BCPR5E-11
PK20TT	3452	BKR6EKP-11	PQ16TT	7090	BKR5EGP	Q16R-U	1266	BCPR5EY
PK20TT	3500	PFR6B	PQ20R	3350	BCPR6EP-11	Q16R-U11	2441	BCPR5EY-11
PK20TT	3546	PFR6N-11	PQ20R8	4793	PFR6G	Q16R-ZU11	3306	BCPR5EIX-11
PK20TT	3586	PZFR6J-11	PQ20R13	3350	BCPR6EP-11	Q16-U	5688	BCPR5EIX
PK20TT	4014	PFR6B-11	PQ20R-P8	5275	BCPR6EP-N-8	Q16-U11	2441	BCPR5EY-11
PK20TT	4115	PFR6G-13	PQ20R-P11	4497	BCPR6EP-N-11	Q16-ZU11	3306	BCPR5EIX-11
PK20TT	4589	IFR6T11	PQ20TT	3350	BCPR6EP-11	Q20PR-P11	4919	BCPR6EIX-11
PK20TT	4639	PFR6L-11	PQ20TT	4045	PFR6A-11	Q20PR-U	2330	BCPR6ES
PK20TT	4793	PFR6G	PQ20TT	4497	BCPR6EP-N-11	Q20PR-U11	5632	BCPR6E-11
PK20TT	4867	IFR6B-K	PQ20TT	5275	BCPR6EP-N-8	Q20PR-ZU11	4919	BCPR6EIX-11
PK20TT	5266	IZFR6K-11S	PQ20TT	6290	PFR6H-10	Q20R-U	2330	BCPR6ES
PK20TT	5344	IFR6D10	PQ20TT	7088	BCPR6EGP	Q20R-ZU11	4919	BCPR6EIX-11
PK20TT	5368	IFR6B11	PT16EPR10	93858	TR5BP12	Q20U11	2756	BKR6E-11
PK20TT	5547	PFR6W-TG	PT16EPR13	5809	TR6AP-13	Q20U11	3735	BCPR6E
PK20TT	5555	PFR6G-11	PT16EPR-C13	7740	PTR5C-13	Q20-U	3735	BCPR6E
PK20TT	5648	IFR6Q-G	PT16EPR-L13	7740	PTR5C-13	Q20-ZU11	4919	BCPR6EIX-11
PK20TT	5874	PFR6U-11G	PT16TT	1209	PTR4G-15	Q22PR-P11	5691	BCPR7EIX-11
PK20TT	6507	IFR6B	PT16TT	1465	IZTR5B11	Q22PR-U	6282	BCPR7ES
PK20TT	6741	IFR6E11	PT16TT	3186	TR5GP	Q22PR-U11	5691	BCPR7EIX-11
PK20TT	6994	IZFR6K11	PT16TT	3403	TR55GP	Q22PR-ZU	5690	BCPR7EIX
PK20TT	7092	BKR6EGP	PT16TT	3784	PTR5D-10	Q22PR-ZU11	5691	BCPR7EIX-11
PK20TT	7658	IFR6J11	PT16TT	4213	IZTR4A11	Q22P-U	5690	BCPR7EIX

NOTE: Cross references are provided as a GUIDE ONLY. Due to differences in design / materials, products produced by various mfrs may have different specifications. Please refer to specific application guide for proper usage.

REMARQUE: Les références sont fournies en GUIDE UNIQUEMENT. En raison des différences de conception et de matériaux, des produits fabriqués par différents fabricants peuvent avoir des spécifications différentes. Veuillez vous référer au guide d'application spécifique pour l'utilisation correcte.



Competitor #	NGK Stock #	NGK Part #	Competitor #	NGK Stock #	NGK Part #	Competitor #	NGK Stock #	NGK Part #
DENSO			DENSO			DENSO		
Q22P-U11	5691	BCPR7EIX-11	T20EPR-U	7300	TR4IX	U31FE-ZU-9	6216	CR9EHIX-9
QJ16AR-U	7558	ZFR5F	T20EPR-U15	3951	TR55	VK16	5464	BKR5EIX-11
QJ16C11	5084	ZFR5A-11	T20EP-U	7300	TR4IX	VK16PRZ-11	3657	IZFR5K11
QJ16CR11	5084	ZFR5A-11	T20ERR-U	3689	TR6IX	VK20	3764	BKR6EIX-11
QJ16HR-U	7252	FR5-1	T20EX-U	3623	BPR6EFS	VK20	4294	IZFR6H11
QJ20C11	1041	ZFR6A-11	T20NR-U11	4177	TR6	VK20PRZ-11	6994	IZFR6K11
QJ20CR11	1041	ZFR6A-11	T20PR-U11	7773	UR6	VK20T	6418	BKR6EIX
QJ20CR-11	1041	ZFR6A-11	T20PR-U15	7773	UR6	VK20Y	6418	BKR6EIX
RU01-31	4216	R0045Q-10	TJ16R15	7164	TR55IX	VK22	2667	BKR7EIX
S22PR-A7	3106	IGR7A-G	TR20	7534	B6HS	VK22PR-Z11	5114	IFR7L11
S29	7746	IFR7G-11KS	TR22	4122	BR7HS	VK24PP-Z11	5068	IFR8H11
S29A	6917	BUR7EQ	TR24	4322	BR8HS	VK24PR-Z11	5068	IFR8H11
S31A	5777	BUR9EQ	U16FS-L	7840	CR5HSA	VK27PR-Z11	6588	IFR9H11
SC16HR11	4912	ILKAR7B11	U16FSR-L	7840	CR5HSA	VKH16	4469	IFR5AIX-11
SC20HR11	4912	ILKAR7B11	U16FSR-U	7840	CR5HSA	VKH20	1208	ILZFR6D11
SK16HR11	6240	PLFR5A-11	U16FS-U	7840	CR5HSA	VKH20	6619	IFR6AIX-11
SK16HR11	96779	ILFR5T11	U17F	7840	CR5HSA	VKH22	2309	IFR7AIX
SK16PR-11	3107	IFR5G-11K	U20EPR9	6899	CPR6EA-9	VKJ20RZM11	3521	CR9EIX
SK16PR-A11	7994	IFR5E11	U20ESR-N	6965	CR6E	VKJ20RZ-M11	4095	IZFR6F11
SK16PR-E11	5464	BKR5EIX-11	U20FS	3228	C6HSA	VNH27Z	4888	IFR9B-9H
SK16PR-F8	3508	IFR5T-8N	U20FS-L	2983	CR6HSA	VQ16	3306	BCPR5EIX-11
SK16PR-L11	3107	IFR5G-11K	U20FSR-L	2983	CR6HSA	VQ20	4919	BCPR6EIX-11
SK16R11	4996	IFR5T11	U20FSR-U	2983	CR6HSA	VUH24D	3653	IFR8C-9H
SK16R-P8	3508	IFR5T-8N	U20FS-U	3228	C6HSA	VUH24Z	3653	IFR8C-9H
SK16R-P11	4996	IFR5T11	U20FSZU	7544	CR7HIX	VUH27D	6777	IFR9C-9H
SK20BR11	5547	PF6W-TG	U22ESN	5096	C7E	VUH27ES	5766	IFR9C-9HES
SK20HPR-L11	4458	ILFR6J-11K	U22ES-N	5096	C7E	VUH27Z	6966	IFR9A-9H
SK20HR11	4904	ILFR6T11	U22ESR-N	4578	CR7E	VW20T	6637	BPR6EIX
SK20PR-A8	6741	IFR6E11	U22ETR	7546	CR7EK	VX22BC	7901	IJR7A9
SK20PR-A11	6741	IFR6E11	U22FER9	3486	CR7EH-9	VX22BZ	7901	IJR7A9
SK20PR-L11	92085	IFR6V-10G	U22FS	4629	C7HSA	VXU22	6046	DCPR7EIX
SK20R11	4589	IFR6T11	U22FS-L	4549	CR7HSA	W9EP	2264	BPR2ES
SK20R-P11	4589	IFR6T11	U22FSR-L	4549	CR7HSA	W9EXR-U	2264	BPR2ES
SK22PR-M11	7746	IFR7G-11KS	U22FSR-U	4549	CR7HSA	W9EXU	2264	BPR2ES
SK22PR-M11S	7746	IFR7G-11KS	U22FS-U	4629	C7HSA	W14	3210	B-4
SKJ16CR-A8	3741	PZFR5F	U22FS-ZU	7544	CR7HIX	W14EKR-S11	5370	BUR4EB-11
SKJ16CR-L11	4363	PZFR5F-11	U24ESN	7471	C8E	W14EXR-U15	4268	GR45
SKJ16DR-M11	3657	IZFR5K11	U24ESR-N	1275	CR8E	W14EXR-ZU	2763	GR4GP
SKJ20CR-A8	4095	IZFR6F11	U24ESR-NB	7784	CR8EB	W14EXZU	2763	GR4GP
SKJ20DR-M11	5266	IZFR6K-11S	U24ESR-NZU	4218	CR8EIX	W14FP	7823	BPR4HS
SKJ20DR-M11	6994	IZFR6K11	U24ETR	3478	CR8EK	W14FP-L	3611	BP4HS
SKJ20DR-M13	6994	IZFR6K11	U24FER9	5666	CR8EH-9	W14FPR	3611	BP4HS
SVK20RZ8	2215	BKR6EP-8	U24FER-ZU9	3797	CR8EHIX-9	W14FPR-L	7823	BPR4HS
SVK20RZ8	4867	IFR6B-K	U24FS	6821	C8HSA	W14FPR-U	7823	BPR4HS
SVK20RZ8	6418	BKR6EIX	U24FS-L	2086	CR8HSA	W14FPR-UL	7823	BPR4HS
SVK20RZ11	3764	BKR6EIX-11	U24FSR-U	2086	CR8HSA	W14FP-U	3611	BP4HS
SXE24HCR8S	95112	ILZKAR8H8S	U24FSR-ZU	7669	CR8HIX	W14FP-UL	3611	BP4HS
SXU22HCR-11S	5787	ILZKR7B-11S	U24FS-U	6821	C8HSA	W14L	3112	B-4L
SXU22HDR8	1989	ILKR7B8	U24FS-ZU	7669	CR8HIX	W14PR-U	5858	XR4
SXU22PR9	91715	IKR7H8	U27ESN	7499	C9E	W14PR-U15	4536	XR45
T14PR-U	6630	UR4	U27ES-NZU	3521	CR9EIX	W14P-U	5858	XR4
T14PR-U15	6945	UR45	U27ES-N-ZU	3521	CR9EIX	W14-U	3210	B-4
T16EPR-U	7300	TR4IX	U27ESRN	6263	CR9E	W14-U10	3210	B-4
T16EPR-U15	3951	TR55	U27ESR-NB	6955	CR9EB	W14US	3210	B-4
T16NR-U11	2238	TR5	U27ESR-NZU	3521	CR9EIX	W16EKR-S11	6735	BUR5EB-11
T16PR-U	6630	UR4	U27ETR	4548	CR9EK	W16EP	7832	BP5ES
T16PR-U11	6630	UR4	U27FE9	7502	CR9EH-9	W16EPR11	7634	BPR5ES-11
T16PR-U15	6945	UR45	U27FER9	7502	CR9EH-9	W16EPR-S11	7634	BPR5ES-11
T16PR-U20	6945	UR45	U27FER-ZU9	6216	CR9EHIX-9	W16EPR-U	7734	BPR5ES
T16P-U	6630	UR4	U27FE-ZU9	6216	CR9EHIX-9	W16EPR-U10	2851	GR5
T16R-U	7052	YR5	U31ESN-ZU	6482	CR10EIX	W16EPR-U10	7634	BPR5ES-11
T16R-U15	7516	YR5IX	U31ESRN	6264	CR10E	W16EPR-U11	7634	BPR5ES-11
T20EPR-U	2238	TR5	U31ESRNZU	6482	CR10EIX	W16EPU11	6937	BPR5EY-11
T20EPR-U	3623	BPR6EFS	U31ETR	2360	CR10EK	W16EP-U	7832	BP5ES

**NOTE:** Cross references are provided as a GUIDE ONLY. Due to differences in design / materials, products produced by various mfrs may have different specifications. Please refer to specific application guide for proper usage.

**440 NOTA:** El cruce de referencias servirá únicamente como guía. Las diferencias en diseño, materiales y los productos utilizados para su elaboración pueden variar dependiendo del fabricante. Para obtener la aplicación correcta de su vehículo, por favor referirse a la sección correspondiente dentro de esta guía.



Competitor #	NGK Stock #	NGK Part #	Competitor #	NGK Stock #	NGK Part #	Competitor #	NGK Stock #	NGK Part #
DENSO			DENSO			DENSO		
W16EP-U10	97382	GR4IX	W20EX-ZU	6637	BPR6EIX	W22MPUS	7321	BPM7A
W16EP-ZU	6597	BPR5EIX	W20FP	7331	BP6HS	W24EMRC	3035	BR8ECM
W16ES	6410	B5ES	W20FP-L	4632	BPR6HSA	W24EP	2912	BP8ES
W16ESL-11	5866	BR5ES	W20FPR	7022	BPR6HS	W24EPR	3923	BPR8ES
W16ES-L	5866	BR5ES	W20FPR-L	4632	BPR6HSA	W24EPR-U	3923	BPR8ES
W16ESR-L	5866	BR5ES	W20FPR-U	7022	BPR6HS	W24EPR-ZU	3923	BPR8ES
W16ESR-U	5866	BR5ES	W20FPR-U10	2633	BPR6HS-10	W24EP-U	2912	BP8ES
W16ES-U	6410	B5ES	W20FPR-UL10	2633	BPR6HS-10	W24ES	2411	B8ES
W16ETR-S	5685	BPR5EKU	W20FPR-ZU	4085	BPR6HIX	W24ES-GU	5044	BR8EIX
W16EX	1233	BPR5EY	W20FP-U	7331	BP6HS	W24ESR	5422	BR8ES
W16EXR-U	1233	BPR5EY	W20FRL	4296	BR6HSA	W24ESR-U	5422	BR8ES
W16EXR-U	2635	GR4	W20FS	7534	B6HS	W24ESR-V	3130	BR8EG
W16EXR-U	7734	BPR5ES	W20FS-GU	3419	BR6HIX	W24ESR-ZU	5044	BR8EIX
W16EXR-U11	6937	BPR5EY-11	W20FSR	3922	BR6HS	W24ES-U	2411	B8ES
W16EXR-ZU	6597	BPR5EIX	W20FSRU	3922	BR6HS	W24ES-U11	2411	B8ES
W16EX-U	7734	BPR5ES	W20FS-U	7534	B6HS	W24ES-V	5044	BR8EIX
W16EX-U11	7734	BPR5ES	W20FS-ZU	3419	BR6HIX	W24ES-ZU	5044	BR8EIX
W16EX-ZU	6597	BPR5EIX	W20PR-U	3522	BR6S	W24FPR	3725	BPR8HS
W16FP	4111	BP5HS	W20PSR-U	3522	BR6S	W24FPR-U10	3725	BPR8HS
W16FPR	6222	BPR5HS	W21ES-L11	6931	BR6EB-L-11	W24FR-L	5539	BR8HSA
W16FPR-U	6222	BPR5HS	W21ESR-L11	6931	BR6EB-L-11	W24FS	5510	B8HS
W16FP-U	4111	BP5HS	W22EA	5877	BR7ET	W24FS-GU	7001	BR8HIX
W16FPUL	4111	BP5HS	W22EB	5877	BR7ET	W24FSR	4322	BR8HS
W16FS	4210	B5HS	W22EBR	5877	BR7ET	W24FSU10	5126	B8HS-10
W16FSR	3722	BR5HS	W22EKR-S11	6832	BUR7EB-11	W24FS-U	5510	B8HS
W16FS-U	4210	B5HS	W22EK-S11	6832	BUR7EB-11	W24FS-ZU	7001	BR8HIX
W16LS	3212	B-6L	W22EP	1034	BP7ES	W25EA	6612	BR8ET
W16PR-U	3722	BR5HS	W22EP11	7226	BPR7ES-11	W25EB	6612	BR8ET
W16P-U	4210	B5HS	W22EPB	5877	BR7ET	W25EBR	6612	BR8ET
W16S-U	3522	BR6S	W22EP-GU	4055	BPR7EIX	W25EDR	2329	BR8EQ-14
W17ES	4922	BR6ES	W22EPR	5534	BPR7ES	W25EDR14	2329	BR8EQ-14
W20EKR-S11	7037	BUR6EB-11	W22EPR11	7226	BPR7ES-11	W25EN	3430	B8EG
W20EK-S11	7037	BUR6EB-11	W22EPR-U	5534	BPR7ES	W25FN	7001	BR8HIX
W20EP	7333	BP6ES	W22EPR-U11	7226	BPR7ES-11	W27AZ	5583	R6254E-9
W20EPB	1263	BP6ET	W22EPR-ZU	4055	BPR7EIX	W27EDR	5777	BUR9EQ
W20EPBR-S	7517	BUR6ET	W22EPR-ZU11	6988	BKR7EIX-11	W27EDR14	5777	BUR9EQ
W20EP-GU	6637	BPR6EIX	W22EP-U	1034	BP7ES	W27EMRC	3252	BR9ECM
W20EPR	7131	BPR6ES	W22EP-U11	7226	BPR7ES-11	W27EMR-ZU	2707	BR9ECMIX
W20EPR11	7133	BPR6ES-11	W22EP-ZU	4055	BPR7EIX	W27EN	3530	B9EG
W20EPR-S11	4690	BUR6EA-11	W22ES	1111	B7ES	W27EPT	3981	BR9EIX
W20EPR-U	7131	BPR6ES	W22ES-GU	6664	BR7EIX	W27ES	2611	B9ES
W20EPR-U10	7133	BPR6ES-11	W22ES-L	5122	BR7ES	W27ES-C	4677	BR9ECS
W20EPR-U11	7133	BPR6ES-11	W22ES-L11	6832	BUR7EB-11	W27ES-GU	3981	BR9EIX
W20EPR-ZU	6637	BPR6EIX	W22ESR	5122	BR7ES	W27ESR	5722	BR9ES
W20EPR-ZU11	3903	BPR6EIX-11	W22ESR-L	5122	BR7ES	W27ESR-U	5722	BR9ES
W20EP-S11	4690	BUR6EA-11	W22ESR-L11	5122	BR7ES	W27ESR-V	3230	BR9EG
W20EP-U	7333	BP6ES	W22ESR-U	5122	BR7ES	W27ESR-ZU	3981	BR9EIX
W20EP-ZU	6637	BPR6EIX	W22ES-U	1111	B7ES	W27ES-U	2611	B9ES
W20ES	7432	B6ES	W22ES-ZU	6664	BR7EIX	W27ES-V	3530	B9EG
W20ES-L	7432	B6ES	W22EXR-U	5534	BPR7ES	W27ES-ZU	3981	BR9EIX
W20ESR	4922	BR6ES	W22EX-U	1034	BP7ES	W27FN	5687	BR9HIX
W20ESR-L	4922	BR6ES	W22FP	5111	BP7HS	W27FS	5810	B9HS
W20ESR-U	4922	BR6ES	W22FPR	6422	BPR7HS	W27FS-GU	5687	BR9HIX
W20ES-U	7432	B6ES	W22FPR-U	6422	BPR7HS	W27FSR	4522	BR9HS
W20ES-ZU	7432	B6ES	W22FPR-ZU	5944	BPR7HIX	W27FS-U	5810	B9HS
W20ETR-L	6757	BPR6EKN	W22FP-U	5111	BP7HS	W27FS-ZU	5687	BR9HIX
W20ETR-L8	6757	BPR6EKN	W22FP-US	5111	BP7HS	W29AZ	5583	R6254E-9
W20EXR-U	6427	BPR6EY	W22FS	5110	B7HS	W29ES-GU	6801	BR10EIX
W20EXR-U11	6261	BPR6EY-11	W22FS-GU	7067	BR7HIX	W29ESR-V	3830	BR10EG
W20EXR-U13	7133	BPR6ES-11	W22FSR	4122	BR7HS	W29ES-V	3630	B10EG
W20EXR-ZU	6637	BPR6EIX	W22FSR-U	4122	BR7HS	W29ES-ZU	6801	BR10EIX
W20EX-U	7131	BPR6ES	W22FS-U	5110	B7HS	W31EMRC	4234	BR10ECM
W20EX-U	7333	BP6ES	W22FS-ZU	7067	BR7HIX	W31EMR-ZU	3006	BR10ECMIX
W20EX-U11	7133	BPR6ES-11	W22MP-U	7321	BPM7A			

**NOTE:** Cross references are provided as a GUIDE ONLY. Due to differences in design / materials, products produced by various mfrs may have different specifications. Please refer to specific application guide for proper usage.

**REMARQUE:** Les références sont fournies en GUIDE UNIQUEMENT. En raison des différences de conception et de matériaux, des produits fabriqués par différents fabricants peuvent avoir des spécifications différentes. Veuillez vous référer au guide d'application spécifique pour l'utilisation correcte.





Competitor #	NGK Stock #	NGK Part #	Competitor #	NGK Stock #	NGK Part #	Competitor #	NGK Stock #	NGK Part #
<b>DENSO</b>			<b>DENSO</b>			<b>e3</b>		
W31EN	3630	B10EG	XU22EP-ZU	6046	DCPR7EIX	E3.48	6962	BKR6E
W31ES	7928	B10ES	XU22HDR9	5847	LKR7B-9	E3.52	3332	XR5
W31ESR-U	4832	BR10ES	XU24EPR-P	6546	DCPR8EIX	E3.53	4177	TR6
W31ESR-ZU	6801	BR10EIX	XU24EPR-U	4339	DCPR8E	E3.54	3951	TR55
W31ES-U	7928	B10ES	XU24EPR-ZU	6546	DCPR8EIX	E3.56	3735	BCPR6E
W31FS	2399	B10HS	XU24EP-U	4339	DCPR8E	E3.56	4291	ZFR6F-11
W31FS-U	2399	B10HS	XU24EP-ZU	6546	DCPR8EIX	E3.58	7252	FR5-1
W31FS-ZU	6692	BR10HIX	XU27EPR-U	2641	DCPR9E	E3.60	7060	TR5-1
W32EPT	6801	BR10EIX	XU27EPR-ZU	2316	DCPR9EIX	E3.62	3951	TR55
W34EN	6801	BR10EIX	Y27FER	5869	ER9EH	E3.64	6953	BKR5E-11
W34EPT	6801	BR10EIX	Y27FERC	5869	ER9EH	E3.66	5306	LZTR4A-11
W34E-ZU	6801	BR10EIX	ZT20EPR11	97287	ITR5H13	E3.68	3672	LFR6A-11
X16EPR-U9	2887	DPR5EA-9	ZTJ16R10	7397	TR5IX	E3.74	4306	LZTR5A-13
X16EP-U9	2887	DPR5EA-9	ZXU20HCR8	93815	SILZKR6B10E	<b>Gator/Oregon</b>		
X20EPR-U9	5531	DPR6EA-9	ZXU22HCR8	95770	ILZKBR7B8DG	77-300	7321	BPM7A
X20EP-U9	1068	DP6EA-9	<b>e3</b>			77-303	6130	BCPR5ES
X20FS-U	6512	D6HA	E3.18	4922	BR6ES	77-310	7832	BP5ES
X22EPR-GL	2842	PJR7A	E3.18	7432	B6ES	77-311	7321	BPM7A
X22EPR-U9	5129	DPR7EA-9	E3.20	2460	BKR5ES	77-312	7131	BPR6ES
X22EPR-ZU9	7803	DPR7EIX-9	E3.20	6719	BKR5E BLYB	77-314	7734	BPR5ES
X22EP-U	5629	DP7EA-9	E3.20	7938	BKR5E	77-315	7333	BP6ES
X22EP-U9	5629	DP7EA-9	E3.22	6427	BPR6EY	77-320	3611	BP4HS
X22EP-ZU9	7803	DPR7EIX-9	E3.22	6775	BPR6ES BLYB	77-321	7534	B6HS
X22ES-U	7912	D7EA	E3.22	7131	BPR6ES	77-323	2411	B8ES
X22ES-ZU	5686	DR7EIX	E3.22	7333	BP6ES	77-400	7321	BPM7A
X22GPR-U	4730	DPR8Z	E3.31	1111	B7ES	<b>Generac</b>		
X24EPR-U9	4929	DPR8EA-9	E3.31	1469	BR9ES BLYB	0E7585	7938	BKR5E
X24EPR-ZU9	2202	DPR8EIX-9	E3.31	1471	BR9EYA BLYB	0E7585A	7938	BKR5E
X24EP-U	5829	DP8EA-9	E3.31	2411	B8ES	0E9368	7022	BPR6HS
X24EP-U9	5829	DP8EA-9	E3.31	2611	B9ES	0G84420101	5534	BPR7ES
X24EP-ZU9	2202	DPR8EIX-9	E3.31	3194	BR9ES SOLID	0H8097	4549	CR7HSA
X24ES-GU	6681	DR8EIX	E3.31	3961	BR8ES SOLID	0H33750169	7333	BP6ES
X24ESR-U	2923	DR8ES-L	E3.31	5722	BR9ES	0J00620108	5534	BPR7ES
X24ESR-ZU	6681	DR8EIX	E3.31	7548	BR9EYA	0K20920111	6422	BPR7HS
X24ESR-ZU9	6681	DR8EIX	E3.32	1445	BR7HS BLYB	<b>Harley Davidson/Screamin' Eagle</b>		
X24ES-U	2120	D8EA	E3.32	1466	BR8HS BLYB	32186-10	6546	DCPR8EIX
X24ES-ZU	6681	DR8EIX	E3.32	1503	BPR7HS BLYB	32189-10	2115	BPR5EIX-11
X24ES-ZU9	6681	DR8EIX	E3.32	1507	BR6HS BLYB	32192-10	6046	DCPR7EIX
X24FSR-U	5123	DR8HS	E3.32	3922	BR6HS	32320-91	6046	DCPR7EIX
X24FS-U	7112	D8HA	E3.32	4122	BR7HS	32321-91	6546	DCPR8EIX
X24FS-ZU	7112	D8HA	E3.32	4322	BR8HS	32322-91	4085	BPR6HIX
X24GPR-U	4730	DPR8Z	E3.32	5110	B7HS	32323-91	2115	BPR5EIX-11
X27EPR-U9	5329	DPR9EA-9	E3.32	5510	B8HS	32326-91	2115	BPR5EIX-11
X27EPR-ZU9	5545	DPR9EIX-9	E3.32	5539	BR8HSA	32327-91	3903	BPR6EIX-11
X27EP-U9	6629	DP9EA-9	E3.32	6422	BPR7HS	31600012	3521	CR9EIX
X27EP-ZU9	5545	DPR9EIX-9	E3.34	6578	BPR4ES SOLID	31600012	6263	CR9E
X27ESR-U	3437	DR9EA	E3.34	6773	BPR5ES BLYB	31600085	3521	CR9EIX
X27ESR-ZU	4772	DR9EIX	E3.34	7734	BPR5ES	31600105	6546	DCPR8EIX
X27ESR-ZU9	4772	DR9EIX	E3.36	3932	DCPR7E	31600106	6046	DCPR7EIX
X27ES-U	2420	D9EA	E3.36	4339	DCPR8E	EVS13P	3903	BPR6EIX-11
X27ES-ZU	4772	DR9EIX	E3.36	92238	DCPR8E BLYB	EVS13S	2115	BPR5EIX-11
X27ES-ZU9	4772	DR9EIX	E3.38	1275	CR8E	EX12P	6546	DCPR8EIX
X27ET	2170	J9A	E3.38	1482	CR7E BLYB	EX12S	6046	DCPR7EIX
X27ETR	3188	JR9B	E3.38	1490	CR8E BLYB	HD2	3212	B-6L
X27GPR-U	4830	DPR9Z	E3.38	1491	CR9EB BLYB	HD3	3212	B-6L
X29ES-ZU	4772	DR9EIX	E3.38	1493	CR9EK BLYB	HD4	3212	B-6L
XU20EPR-U	3481	DCPR6E	E3.38	4548	CR9EK	HD4A	3212	B-6L
XU20EPRZU	3481	DCPR6E	E3.38	4578	CR7E	HD4R	3212	B-6L
XU20EP-U	3481	DCPR6E	E3.38	5096	C7E	HD4R5	7022	BPR6HS
XU22EPP	6046	DCPR7EIX	E3.38	6955	CR9EB	HD4R5G	7022	BPR6HS
XU22EPR-P	6046	DCPR7EIX	E3.40	2771	UR5	HD5	3522	BR6S
XU22EPR-U	3932	DCPR7E	E3.42	6630	UR4	HD5A6A	7634	BPR5ES-11
XU22EPR-ZU	6046	DCPR7EIX	E3.44	2238	TR5	HD5-A6	7634	BPR5ES-11
XU22EP-U	3932	DCPR7E	E3.46	2851	GR5	HD5R6	7634	BPR5ES-11

NOTE: Cross references are provided as a GUIDE ONLY. Due to differences in design / materials, products produced by various mfrs may have different specifications. Please refer to specific application guide for proper usage.

442 NOTA: El cruce de referencias servirá únicamente como guía. Las diferencias en diseño, materiales y los productos utilizados para su elaboración pueden variar dependiendo del fabricante. Para obtener la aplicación correcta de su vehículo, por favor referirse a la sección correspondiente dentro de esta guía.





Competitor #	NGK Stock #	NGK Part #	Competitor #	NGK Stock #	NGK Part #	Competitor #	NGK Stock #	NGK Part #
<b>Harley Davidson/Screamin' Eagle</b>			<b>Magneti Marelli</b>			<b>Magneti Marelli</b>		
HD5R6A	7634	BPR5ES-11	7LCR	6962	BKR6E	CW7NJ	7534	B6HS
HD6	1111	B7ES	7LPR	6962	BKR6E	CW7NP	7331	BP6HS
HD6R10	6955	CR9EB	8LCR	6282	BCPR7ES	CW7NPR	7022	BPR6HS
HD6R12	3932	DCPR7E	8LDCR	2467	PTR5A-13	CW7NR	3922	BR6HS
HD6R12	6046	DCPR7EIX	8LPR	6282	BCPR7ES	CW8L	1111	B7ES
HD6RL	1034	BP7ES	61830072304	6282	BCPR7ES	CW8LCR	6282	BCPR7ES
HD7	2411	B8ES	61830085304	5534	BPR7ES	CW8LJ	1111	B7ES
HD7-8	5722	BR9ES	61830086304	6962	BKR6E	CW8LP	1034	BP7ES
HD8	3630	B10EG	61830175304	1034	BP7ES	CW8LPR	5534	BPR7ES
HD10R12	4339	DCPR8E	61830176304	7331	BP6HS	CW8LPS	1034	BP7ES
HD10R12	6546	DCPR8EIX	61830210304	7333	BP6ES	CW8N	5110	B7HS
HD10R12A	4339	DCPR8E	61830211304	7131	BPR6ES	CW8NP	5111	BP7HS
HD10R12A	6546	DCPR8EIX	61830215304	3623	BPR6EFS	CW8NR	4122	BR7HS
RG6HCC	3521	CR9EIX	61830254304	6962	BKR6E	CW9L	2411	B8ES
RG6HCC	6263	CR9E	61830257304	7022	BPR6HS	CW9LJ	2411	B8ES
SH13S	2115	BPR5EIX-11	61830258304	4111	BP5HS	CW9LP	2912	BP8ES
X12P	3932	DCPR7E	61830262304	3623	BPR6EFS	CW9N	5510	B8HS
XL10S	4085	BPR6HIX	61850023304	2467	PTR5A-13	CW10L	3430	B8EG
<b>John Deere</b>			62000611304	7534	B6HS	CW11L	3530	B9EG
AM132420	2238	TR5	62000654304	7331	BP6HS	CW12L	3530	B9EG
B1DR8EA	7162	DR8EA	62000739304	7333	BP6ES	CW13L	3630	B10EG
ET12355	3611	BP4HS	62000740304	7131	BPR6ES	CW14L	3630	B10EG
M138938	2264	BPR2ES	62000754304	7331	BP6HS	CW55N	4210	B5HS
M152222	4339	DCPR8E	CM3N	2910	AB-6	CW67L	7432	B6ES
M802138	7734	BPR5ES	CM4N	2910	AB-6	CW67LP	7333	BP6ES
MIU12783	7092	BKR6EGP	CM5N	2910	AB-6	CW67N	7331	BP6HS
MIU13325	7938	BKR5E	CM6N	3010	AB-7	CW67NJ	7534	B6HS
MIU13363	4455	CR7EKB	CU7N	4629	C7HSA	CW67NR	3922	BR6HS
TY6122	7823	BPR4HS	CW3C	3210	B-4	CW67P	7832	BP5ES
TY26704	5077	ZGR5A	CW3CJ	3210	B-4	CW75LP	7333	BP6ES
TY26709	7938	BKR5E	CW4A	6410	B5ES	CW78L	7432	B6ES
TY26710	4122	BR7HS	CW4C	3210	B-4	CW78LP	7333	BP6ES
TY26716	5422	BR8ES	CW4CJ	3210	B-4	CW78LPR	7131	BPR6ES
TY26717	5722	BR9ES	CW5C	3210	B-4	CW78LPS	7333	BP6ES
TY26718	5722	BR9ES	CW5L	6410	B5ES	CW89LP	1034	BP7ES
TY26720	7788	BPR9ES	CW5LJ	6410	B5ES	CW112L	3530	B9EG
TY26721	4929	DPR8EA-9	CW5LP	7832	BP5ES	CW225A	7534	B6HS
TY26722	5129	DPR7EA-9	CW5LS	6410	B5ES	CW250A	5110	B7HS
TY26723	6263	CR9E	CW5LSZ	6410	B5ES	CW260N	5110	B7HS
TY26724	2120	D8EA	CW5N	4210	B5HS	CWC6NJ	7534	B6HS
<b>Kohler</b>			CW5NJ	4210	B5HS	CWC7NJ	7534	B6HS
235040S	3212	B-6L	CW5NP	4111	BP5HS	CWC9NJ	5110	B7HS
235041S	3212	B-6L	CW5NR	3722	BR5HS	CWC12NJ	5510	B8HS
1213202	7938	BKR5E	CW5NS	4210	B5HS	CWC67NJ	7534	B6HS
1213202S	7938	BKR5E	CW5NSZ	4210	B5HS	CWF11L	5044	BR8EIX
1413203S	6962	BKR6E	CW6L	6410	B5ES	CWP5N	3419	BR6HIX
1413211S	3481	DCPR6E	CW6LJ	6410	B5ES	CWP6N	3419	BR6HIX
1413212S	3932	DCPR7E	CW6LP	7832	BP5ES	CWP7N	3419	BR6HIX
2013202	6962	BKR6E	CW6LR	5866	BR5ES	CWP8L	6664	BR7EIX
2013202S	6962	BKR6E	CW6LS	6410	B5ES	CWP8N	7067	BR7HIX
2513208S	4853	PFR7B	CW6LSZ	6410	B5ES	CWP9L	5044	BR8EIX
2513210S	3212	B-6L	CW6N	7534	B6HS	CWP9N	7001	BR8HIX
2513212S	7938	BKR5E	CW6NJ	7534	B6HS	CWP10L	3981	BR9EIX
2513214S	7938	BKR5E	CW6NP	7331	BP6HS	CWP10N	5687	BR9HIX
2513225S	3932	DCPR7E	CW6NPR	7022	BPR6HS	CX6N	6512	D6HA
5213202S	6630	UR4	CW6NR	3922	BR6HS	CX8L	2120	D8EA
6213204	6962	BKR6E	CW7L	7432	B6ES	CX8N	7112	D8HA
6213204S	6962	BKR6E	CW7LCR	6962	BKR6E	DW4CJR	3522	BR6S
6613201S	7734	BPR5ES	CW7LJ	7432	B6ES	F6NC	4111	BP5HS
6613201S	7938	BKR5E	CW7LP	7333	BP6ES	F6NCR	6222	BPR5HS
<b>Kubota</b>			CW7LPH	7333	BP6ES	F7LC	7333	BP6ES
12691-67710	5424	BKR4E-11	CW7LPR	7131	BPR6ES	F7LCR	7131	BPR6ES
E9151-67710	4421	BKR4E	CW7LR	4922	BR6ES	F7NC	7331	BP6HS
			CW7N	7534	B6HS	F7NCR	7022	BPR6HS

**NOTE:** Cross references are provided as a GUIDE ONLY. Due to differences in design / materials, products produced by various mfrs may have different specifications. Please refer to specific application guide for proper usage.

**REMARQUE:** Les références sont fournies en GUIDE UNIQUEMENT. En raison des différences de conception et de matériaux, des produits fabriqués par différents fabricants peuvent avoir des spécifications différentes. Veuillez vous référer au guide d'application spécifique pour l'utilisation correcte.



Competitor #	NGK Stock #	NGK Part #	Competitor #	NGK Stock #	NGK Part #	Competitor #	NGK Stock #	NGK Part #
<b>Magneti Marelli</b>			<b>Motorcraft</b>			<b>Motorcraft</b>		
F8LC	1034	BP7ES	AF4C	7052	YR5	AGPR12PP8	4853	PFR7B
F8LCR	5534	BPR7ES	AF42	7177	UR5IX	AGPR22C	6962	BKR6E
FC6N	4210	B5HS	AF42C	6630	UR4	AGPR22C1	5553	BKR6ES-11
FC7N	7534	B6HS	AF42CF8	6630	UR4	AGPR22CD	6364	BKR6ES
FC9L	2912	BP8ES	AF52	7401	UR4IX	AGPR22CD1	5553	BKR6ES-11
T7LC	3623	BPR6EFS	AF52C	6630	UR4	AGPR22P	3764	BKR6EIX-11
T7LCR	3623	BPR6EFS	AG1	1111	B7ES	AGPR22PP	4014	PFR6B-11
TW7LP	3623	BPR6EFS	AG1C	2411	B8ES	AGPR22PPJ	4014	PFR6B-11
TW7LPR	3623	BPR6EFS	AG1CX	1111	B7ES	AGPR32C	2330	BCPR6ES
TW78LP	3623	BPR6EFS	AG1X	2411	B8ES	AGPR32C	7373	FR5
TW78LPR	3623	BPR6EFS	AG2	1111	B7ES	AGPR32CD1	5553	BKR6ES-11
<b>Motorcraft</b>			AG2C	1111	B7ES	AGPR32PD	2890	BKR5EKUP
1Y00	7734	BPR5ES	AG2CU	1111	B7ES	AGPS12C	6282	BCPR7ES
1Y0A	2756	BKR6E-11	AG2X	1111	B7ES	AGPS12P1	6988	BKR7EIX-11
1Y0B	5791	BKR7E-11	AG3	7432	B6ES	AGPS22C	6364	BKR6ES
1Y0F	3932	DCPR7E	AG3C	7432	B6ES	AGPS22C1	5553	BKR6ES-11
1Y0G	2262	ZFR5F-11	AG3X	7432	B6ES	AGPS22P	3764	BKR6EIX-11
1Y0H	4291	ZFR6F-11	AG4	6410	B5ES	AGPS22P1	3764	BKR6EIX-11
1Y01	7131	BPR6ES	AG5	6410	B5ES	AGPS22PP1	4014	PFR6B-11
1Y03	7634	BPR5ES-11	AG5CU	6410	B5ES	AGPS32C	6364	BKR6ES
1Y06	7938	BKR5E	AG12	1034	BP7ES	AGPS32C1	5553	BKR6ES-11
1Y07	6962	BKR6E	AG12C	1034	BP7ES	AGPS44F	7968	PZFR5D-11
1Y09	6953	BKR5E-11	AG12CU	1034	BP7ES	AGPS44F11	7968	PZFR5D-11
A7	3210	B-4	AG22	7333	BP6ES	AGPS44F11J	7968	PZFR5D-11
A7C	3210	B-4	AG22C	7333	BP6ES	AGR1X	5422	BR8ES
A7CX	3210	B-4	AG22CU	7333	BP6ES	AGR2C	5122	BR7ES
A7U	3210	B-4	AG25C	5877	BR7ET	AGR2X	5122	BR7ES
A7X	3210	B-4	AG32A	7333	BP6ES	AGR3X	4922	BR6ES
A9	3210	B-4	AG32C	7333	BP6ES	AGR12C	5534	BPR7ES
A9X	3210	B-4	AG32CU	7333	BP6ES	AGR16C	6612	BR8ET
A22NX	7321	BPM7A	AG34CU11	6427	BPR6EY	AGR21	4922	BR6ES
A42	2298	R5670-5	AG42	7832	BP5ES	AGR22	2851	GR5
A42C	2298	R5670-5	AG42C	7832	BP5ES	AGR22	7131	BPR6ES
A42CU	2298	R5670-5	AG42CU	7832	BP5ES	AGR22C	2851	GR5
A52	2298	R5670-5	AG44	6334	ZGR5C	AGR22C	7131	BPR6ES
A52C	2298	R5670-5	AG52	7832	BP5ES	AGR22CU	7131	BPR6ES
A52CU	7355	XR5IX	AG54	6334	ZGR5C	AGR31	4922	BR6ES
A82	5858	XR4	AG92C	2411	B8ES	AGR32	2851	GR5
AE1C	5110	B7HS	AG203	6801	BR10EIX	AGR32	7131	BPR6ES
AE1X	5110	B7HS	AG252	7333	BP6ES	AGR32C	2851	GR5
AE2	5110	B7HS	AG252C	7333	BP6ES	AGR32C	7131	BPR6ES
AE2C	5110	B7HS	AG501	7928	B10ES	AGR32CU	7131	BPR6ES
AE2X	5110	B7HS	AG603	3981	BR9EIX	AGR34CU	6427	BPR6EY
AE3	7534	B6HS	AG603C	3981	BR9EIX	AGR41	5866	BR5ES
AE3C	7534	B6HS	AG701	2611	B9ES	AGR42	2635	GR4
AE3X	7534	B6HS	AG701C	2611	B9ES	AGR42	7734	BPR5ES
AE4	4210	B5HS	AG701CU	2611	B9ES	AGR42C	2635	GR4
AE4X	4210	B5HS	AG701X	3981	BR9EIX	AGR42C	7734	BPR5ES
AE6	4210	B5HS	AG901	2611	B9ES	AGR42CU	7734	BPR5ES
AE22	7331	BP6HS	AG901C	2611	B9ES	AGR44C	1233	BPR5EY
AE22C	7331	BP6HS	AG901CU	2611	B9ES	AGR44C-11	6937	BPR5EY-11
AE32	7331	BP6HS	AG901X	5044	BR8EIX	AGR44CU	1233	BPR5EY
AE32C	7331	BP6HS	AG902	2912	BP8ES	AGR44CU11	6937	BPR5EY-11
AE42	4111	BP5HS	AG903	3430	B8EG	AGR44CU-11	6937	BPR5EY-11
AE42C	4111	BP5HS	AGF22C	2238	TR5	AGR51	5866	BR5ES
AE52	4111	BP5HS	AGF32C	2238	TR5	AGR52	2635	GR4
AE62	4111	BP5HS	AGF32CU	3623	BPR6EFS	AGR52	7734	BPR5ES
AE91	5810	B9HS	AGFS22C1	3623	BPR6EFS	AGR701X	3981	BR9EIX
AE901	5810	B9HS	AGFS22IPJ	4477	ITR6F13	AGR901X	5044	BR8EIX
AER2X	4122	BR7HS	AGFS22YPC	4477	ITR6F13	AGRF22	2238	TR5
AER4	3722	BR5HS	AGFS32C1	3623	BPR6EFS	AGRF22	3623	BPR6EFS
AER4X	3722	BR5HS	AGN42	7832	BP5ES	AGRF22-6	3951	TR55
AER32	7022	BPR6HS	AGPR12C	4644	BKR7E	AGRF22C	2238	TR5
AES4C	4210	B5HS	AGPR12P	6988	BKR7EIX-11	AGRF22C	3623	BPR6EFS

NOTE: Cross references are provided as a GUIDE ONLY. Due to differences in design / materials, products produced by various mfrs may have different specifications. Please refer to specific application guide for proper usage.

444 NOTA: El cruce de referencias servirá únicamente como guía. Las diferencias en diseño, materiales y los productos utilizados para su elaboración pueden variar dependiendo del fabricante. Para obtener la aplicación correcta de su vehículo, por favor referirse a la sección correspondiente dentro de esta guía.



Competitor #	NGK Stock #	NGK Part #	Competitor #	NGK Stock #	NGK Part #	Competitor #	NGK Stock #	NGK Part #
Motorcraft			Motorcraft			Motorcraft		
AGRF22C1	3623	BPR6EFS	AGSF32YPC	90813	TR5AI-13	ARF8	7052	YR5
AGRF22PP1	3784	PTR5D-10	AGSF32Y-PC	97287	ITR5H13	ARF8-6	7240	YR55
AGRF32	2238	TR5	AGSF32YR	97287	ITR5H13	ARF22	2771	UR5
AGRF32	3623	BPR6EFS	AGSF33C	3754	TR4	ARF22C	2771	UR5
AGRF32-6	3951	TR55	AGSF34C	7060	TR5-1	ARF22CU	7348	UR6IX
AGRF32C1	3623	BPR6EFS	AGSF34CF4	2683	TR55-1	ARF32	2771	UR5
AGRF42	2238	TR5	AGSF34CF4	7060	TR5-1	ARF32-6	2248	UR55
AGRF52	2238	TR5	AGSF34EE	7243	TR5-1IX	ARF32C-6	2248	UR55
AGRP52	4043	ZFR4F-11	AGSF34FM	7159	TR55-1GP	ARF32M	2771	UR5
AGS2C	1111	B7ES	AGSF34FP	7159	TR55-1GP	ARF41C15	7240	YR55
AGS3C	7432	B6ES	AGSF34N	2683	TR55-1	ARF41CU15	7240	YR55
AGS4C	6410	B5ES	AGSF34PP	7243	TR5-1IX	ARF42	6630	UR4
AGS12C	5534	BPR7ES	AGSF42C-6	3951	TR55	ARF42-6	6945	UR45
AGS22C	7131	BPR6ES	AGSF42C-6F6	3951	TR55	ARF42-8	6945	UR45
AGS32C	2635	GR4	AGSF42FM	3403	TR55GP	ARF42C	6630	UR4
AGS32C	7734	BPR5ES	AGSF44FM	7159	TR55-1GP	ARF42CU	6630	UR4
AGS32C11	7634	BPR5ES-11	AGSF52C	3754	TR4	ARF52	6630	UR4
AGS32C-11	7634	BPR5ES-11	AGSF52CF4	3754	TR4	ARF52-6	6945	UR45
AGS32CF4	2635	GR4	AGSP32	2756	BKR6E-11	ARF52-8	6945	UR45
AGS32CF4	2851	GR5	AGSP32	7373	FR5	ARF62	6630	UR4
AGS44	6334	ZGR5C	AGSP32C	2756	BKR6E-11	ARF62-6	6945	UR45
AGS52C-6	4268	GR45	AGSP32C	7092	BKR6EGP	AS4C	3332	XR5
AGS52C-6F4	4268	GR45	AGSP32C	7373	FR5	AS8	5858	XR4
AGS081C	2329	BR8EQ-14	AGSP32CF4	7373	FR5	AS42C	3332	XR5
AGSF2	3623	BPR6EFS	AGSP32FP	2647	PFR5G-11	AS42C-6	4536	XR45
AGSF12C	3623	BPR6EFS	AGSP32FPM	2647	PFR5G-11	AS52C	5858	XR4
AGSF12FM1	3692	TR65IX	AGSP32FSM	7090	BKR5EGP	AS82C-7	4536	XR45
AGSF22C	2238	TR5	AGSP32P	3764	BKR6EIX-11	ASF3C	2771	UR5
AGSF22CF6	2238	TR5	AGSF32PP	2647	PFR5G-11	ASF4C	6630	UR4
AGSF22F1	3403	TR55GP	AGSP32PR	4014	PFR6B-11	ASF4C-6	6945	UR45
AGSF22F1M	3403	TR55GP	AGSP33C	4291	ZFR6F-11	ASF8	7052	YR5
AGSF22FM	3403	TR55GP	AGSP33C	7373	FR5	ASF32	2771	UR5
AGSF22FM1	3403	TR55GP	AGSP33CF4	7373	FR5	ASF32-6F4	2248	UR55
AGSF22FM1	97287	ITR5H13	AGSP52	7938	BKR5E	ASF32C	2771	UR5
AGSF22FSM	3403	TR55GP	AGSP52C	5155	FR4	ASF32C-6	2248	UR55
AGSF22N	3951	TR55	AGSP52C	6953	BKR5E-11	ASF32CF4	2771	UR5
AGSF22PP	6579	PTR5F-11	AGSP52CF6	5155	FR4	ASF32CF6	2248	UR55
AGSF22PP	7397	TR5IX	AGSP54	5084	ZFR5A-11	ASF32M	2771	UR5
AGSF22WM	3403	TR55GP	AL5	3212	B-6L	ASF32P	7177	UR5IX
AGSF22WM	97287	ITR5H13	AL5X	3212	B-6L	ASF42	6630	UR4
AGSF22YPC	4477	ITR6F13	AL7	3212	B-6L	ASF42-6C	7272	UR55IX
AGSF23C	3951	TR55	AL7C	3212	B-6L	ASF42C	6630	UR4
AGSF24C	7060	TR5-1	AL7U	3212	B-6L	ASF42C	6945	UR45
AGSF24CF4	2683	TR55-1	AL7X	3212	B-6L	ASF42C-6	6945	UR45
AGSF24CF4	7060	TR5-1	AL9	3112	B-4L	ASF42C-7	6945	UR45
AGSF24FM	7159	TR55-1GP	AL9X	3112	B-4L	ASF42C-7F4	6945	UR45
AGSF24N	2683	TR55-1	AL11	3112	B-4L	ASF42CF8	6630	UR4
AGSF32C	2238	TR5	AL82	3212	B-6L	ASF42P	7401	UR4IX
AGSF32CF6	2238	TR5	AR5S	5858	XR4	ASF44P	7401	UR4IX
AGSF32FEC	6579	PTR5F-11	AR21X	3522	BR6S	ASF52	7401	UR4IX
AGSF32FEC	7740	PTR5C-13	AR31	3522	BR6S	ASF52-6	6945	UR45
AGSF32FEM	3784	PTR5D-10	AR32	3332	XR5	ASF52-7	6945	UR45
AGSF32FM	3186	TR5GP	AR41	3522	BR6S	ASF52-7F6	6945	UR45
AGSF32FM	3403	TR55GP	AR42	3332	XR5	ASF52-7F8	6945	UR45
AGSF32FM	7740	PTR5C-13	AR51	3522	BR6S	ASF52C	6630	UR4
AGSF32FMF6	7740	PTR5C-13	AR52	5858	XR4	ASF52CF6	6630	UR4
AGSF32FSM	3403	TR55GP	AR82	5858	XR4	ASF52CF8	6630	UR4
AGSF32N	3951	TR55	AR82-6	4536	XR45	AT8	3210	B-4
AGSF32PM	3403	TR55GP	AR82-8	4536	XR45	AT42	3332	XR5
AGSF32PM	7740	PTR5C-13	ARF2-6	7240	YR55	ATL3	3212	B-6L
AGSF32W	7397	TR5IX	ARF3-6	7240	YR55	ATL4	3212	B-6L
AGSF32WM	3403	TR55GP	ARF4	7052	YR5	ATL8	3112	B-4L
AGSF32WM	4477	ITR6F13	ARF4-6	7240	YR55	AV1X	5510	B8HS
AGSF32WM1	3403	TR55GP	ARF6	7052	YR5	AV2C	5110	B7HS

**NOTE:** Cross references are provided as a GUIDE ONLY. Due to differences in design / materials, products produced by various mfrs may have different specifications. Please refer to specific application guide for proper usage.

**REMARQUE:** Les références sont fournies en GUIDE UNIQUEMENT. En raison des différences de conception et de matériaux, des produits fabriqués par différents fabricants peuvent avoir des spécifications différentes. Veuillez vous référer au guide d'application spécifique pour l'utilisation correcte.



Competitor #	NGK Stock #	NGK Part #	Competitor #	NGK Stock #	NGK Part #	Competitor #	NGK Stock #	NGK Part #
Motorcraft			Motorcraft			Motorcraft		
AV2CU	5110	B7HS	AWSF54	7060	TR5-1	BSF31	3323	AR6FS
AV2X	5110	B7HS	AWSF54C	7060	TR5-1	BSF31-4	3323	AR6FS
AV3C	7534	B6HS	AWSF54CF6	2683	TR55-1	BSF42C	2438	WR5
AV3CU	7534	B6HS	AWSF54CF6	7060	TR5-1	BSF42CF6	2438	WR5
AV4	4210	B5HS	AWSFA12C	4177	TR6	BSF42F8	2438	WR5
AV22C	7331	BP6HS	AWSFA32C	2238	TR5	BSF44C	4652	WR4-1
AV22CU	7331	BP6HS	AX9	3210	B-4	BSF44CF6	4652	WR4-1
AV42	4111	BP5HS	AYFS22C	2467	PTR5A-13	BSF44P	4652	WR4-1
AV52	4111	BP5HS	AYFS22FE1J	3587	PLTR6A-10G	BSF44PF6	4652	WR4-1
AV82	3611	BP4HS	AYFS22FM	5019	LTR5GP	BSF44PM	4652	WR4-1
AV901C	5810	B9HS	AYFS22FPM1	2467	PTR5A-13	BSF82C	2438	WR5
AV901CU	5810	B9HS	AYFS22PP	2467	PTR5A-13	BSF82CF6	2438	WR5
AVZK0	2522	BUHX	AYFS22PP1	2467	PTR5A-13	BSF92	2438	WR5
AVZKO	2522	BUHX	AYFS32YR	90607	ILTR5K13	BSF314	3323	AR6FS
AWRF32	2238	TR5	AYFS092FE1	2467	PTR5A-13	BT2	7909	AB-8
AWRF32	3623	BPR6EFS	AYRF22P	2467	PTR5A-13	BT3	3010	AB-7
AWRF32-5	3951	TR55	AYRF22PP	2467	PTR5A-13	BT4	3010	AB-7
AWRF42	2238	TR5	AYSF32YPC	90083	LTR5BI-13	BT6	2910	AB-6
AWSF22C	2238	TR5	AYSF32YPC	90607	ILTR5K13	BT8	2910	AB-6
AWSF22C	3623	BPR6EFS	AZ9	3210	B-4	BT9	2910	AB-6
AWSF22E	7397	TR5IX	AZFS22C	2238	TR5	BT10	2910	AB-6
AWSF22F	5598	PTR6D-13	AZFS22CF4	2238	TR5	BTF42	2438	WR5
AWSF22FM	7397	TR5IX	AZFS22FE	2467	PTR5A-13	BTRF42	2438	WR5
AWSF22FM1	7397	TR5IX	AZFS22PP	2467	PTR5A-13	BZ8	2910	AB-6
AWSF22FS	7397	TR5IX	AZFS32FE	2467	PTR5A-13	CGSF22F	93858	TR5BP12
AWSF24C	7060	TR5-1	B2	7909	AB-8	CGSF22N	92838	TR5C-12
AWSF24CF4	2683	TR55-1	B2W	7909	AB-8	CYFS12F1	90374	LTR6DP13
AWSF24CF4	7060	TR5-1	B3W	3010	AB-7	CYFS12F5	94806	LTR6BP13
AWSF32	2238	TR5	B3X	3010	AB-7	CYFS12Y1	92182	LTR6BI-9
AWSF32	3623	BPR6EFS	B4	3010	AB-7	CYFS12Y2	96588	LTR6DI-8
AWSF32C	2238	TR5	B4X	3010	AB-7	CYFS12Y3	97177	LTR6CI-8
AWSF32C	3623	BPR6EFS	B6	2910	AB-6	CYFS12YEC	96870	ILTR6H8G
AWSF32CF4	2238	TR5	B6W	2910	AB-6	CYFS12YYP	6509	LTR6IX-11
AWSF32E	7397	TR5IX	B8	2910	AB-6	CYFS12YP	90656	ILTR6F9
AWSF32EE	7397	TR5IX	B8X	2910	AB-6	CYFS12YPCFC	96621	ILTR6G8G
AWSF32F	7164	TR55IX	B9	2910	AB-6	CYFS12YT3	97177	LTR6CI-8
AWSF32FM	7397	TR5IX	B82	2438	WR5	HE2	7112	D8HA
AWSF32P	7397	TR5IX	BF22	2438	WR5	HE3	6512	D6HA
AWSF32PM	7397	TR5IX	BF22C	2438	WR5	HG2	2120	D8EA
AWSF32PP	7397	TR5IX	BF22CX	2438	WR5	HG2C	2120	D8EA
AWSF34	7060	TR5-1	BF22X	2438	WR5	HG2CU	2120	D8EA
AWSF34C	7060	TR5-1	BF32	2438	WR5	HG22	2120	D8EA
AWSF34CF4	2683	TR55-1	BF32C	2438	WR5	HG22C	2120	D8EA
AWSF34CF4	7060	TR5-1	BF32CX	2438	WR5	HGR2C	2923	DR8ES-L
AWSF34PP	7243	TR5-1IX	BF32X	2438	WR5	HJFS24FP	5507	PZNR6A11H
AWSF42	3754	TR4	BF42	2438	WR5	HV2	7112	D8HA
AWSF42C	3754	TR4	BF42C	2438	WR5	HV3	6512	D6HA
AWSF42CF4	3754	TR4	BF42CF8	2438	WR5	HV22	6512	D6HA
AWSF42CF6	3754	TR4	BF82C	2438	WR5	MA7CM	3210	B-4
AWSF42EE	7164	TR55IX	BF82CF6	2438	WR5	PE3	3228	C6HSA
AWSF42P	7397	TR5IX	BF92	2438	WR5	PV2	4629	C7HSA
AWSF42PP	7397	TR5IX	BR8	2910	AB-6	PV3	3228	C6HSA
AWSF44	7060	TR5-1	BRF3M	3323	AR6FS	SP400	3951	TR55
AWSF44C	7060	TR5-1	BRF6	3323	AR6FS	SP402	7131	BPR6ES
AWSF44CF4	2683	TR55-1	BRF22	2438	WR5	SP405	3403	TR55GP
AWSF44CF4	7060	TR5-1	BRF22C	2438	WR5	SP405	97287	ITR5H13
AWSF44CF6	2683	TR55-1	BRF31	3323	AR6FS	SP406	2756	BKR6E-11
AWSF44CF6	7060	TR5-1	BRF31-4	3323	AR6FS	SP406	7373	FR5
AWSF44EE	7243	TR5-1IX	BRF32	2438	WR5	SP408	2683	TR55-1
AWSF44P	7243	TR5-1IX	BRF42	2438	WR5	SP408	7060	TR5-1
AWSF44PP	7243	TR5-1IX	BRF82	2438	WR5	SP409	7060	TR5-1
AWSF52C	3754	TR4	BRF314	3323	AR6FS	SP410	6630	UR4
AWSF52CF4	3754	TR4	BSF3	3323	AR6FS	SP411	5019	LTR5GP
AWSF52CF6	3754	TR4	BSF6	2438	WR5	SP412	2683	TR55-1

**NOTE:** Cross references are provided as a GUIDE ONLY. Due to differences in design / materials, products produced by various mfrs may have different specifications. Please refer to specific application guide for proper usage.

**446 NOTA:** El cruce de referencias servirá únicamente como guía. Las diferencias en diseño, materiales y los productos utilizados para su elaboración pueden variar dependiendo del fabricante. Para obtener la aplicación correcta de su vehículo, por favor referirse a la sección correspondiente dentro de esta guía.





Competitor #	NGK Stock #	NGK Part #	Competitor #	NGK Stock #	NGK Part #	Competitor #	NGK Stock #	NGK Part #
Motorcraft			Motorcraft			Torch		
SP414	3323	AR6FS	SP493	7740	PTR5C-13	7026	5368	IFR6B11
SP415	2238	TR5	SP494	4177	TR6	7026	7092	BKR6EGP
SP415	2771	UR5	SP495	5598	PTR6D-13	8012	6637	BPR6EIX
SP417	3403	TR55GP	SP497	7092	BKR6EGP	92089897	5534	BPR7ES
SP419	3754	TR4	SP498	7159	TR55-1GP	A5RTC	7840	CR5HSA
SP420	2438	WR5	SP499	2238	TR5	A6RTC	2983	CR6HSA
SP424	5155	FR4	SP500	3403	TR55GP	A6TC	3228	C6HSA
SP424	6953	BKR5E-11	SP500	6579	PTR5F-11	A7C	4629	C7HSA
SP425	6630	UR4	SP500	7397	TR5IX	A7RC	4549	CR7HSA
SP428	7252	FR5-1	SP501	7177	UR5IX	A7RTC	1488	CR7HSA BLYB
SP429	2683	TR55-1	SP502	7401	UR4IX	A7RTC	4549	CR7HSA
SP429	7060	TR5-1	SP503	7401	UR4IX	A7TC	4549	CR7HSA
SP430	2438	WR5	SP504	7159	TR55-1GP	A8RTC	2086	CR8HSA
SP431	2438	WR5	SP505	2238	TR5	A8TC	2086	CR8HSA
SP432	3186	TR5GP	SP506	2683	TR55-1	B7RC	1482	CR7E BLYB
SP432	7164	TR55IX	SP509	5507	PZNR6A11H	B7RC	4578	CR7E
SP432	7397	TR5IX	SP511	93858	TR5BP12	B7RD	7546	CR7EK
SP432	7740	PTR5C-13	SP512A	97177	LTR6CI-8	B8C	7471	C8E
SP433	3403	TR55GP	SP518	92838	TR5C-12	B8RH	5666	CR8EH-9
SP433	4477	ITR6F13	SP518A	2238	TR5	C6RTC	6512	D6HA
SP435	4652	WR4-1	SP519	95853	LTR6A13	C6TC	6512	D6HA
SP436	2635	GR4	SP520	94806	LTR6BP13	C7E	5096	C7E
SP439	6579	PTR5F-11	SP521	3403	TR55GP	C7TC	5629	DP7EA-9
SP439A	7740	PTR5C-13	SP522	90656	ILTR6F9	C8C	7112	D8HA
SP440	7159	TR55-1GP	SP523	3403	TR55GP	C8E	7471	C8E
SP442	3754	TR4	SP524	2467	PTR5A-13	C9E	7499	C9E
SP443	2248	UR55	SP525	96870	ILTR6H8G	CR7E	4578	CR7E
SP444	7060	TR5-1	SP526	6509	LTR6IX-11	CR8E	1275	CR8E
SP445	4291	ZFR6F-11	SP527	91725	LTR6BI-13	CR9E	6263	CR9E
SP445	7373	FR5	SP528	97177	LTR6CI-8	D5RTC	3481	DCPR6E
SP446	3951	TR55	SP530	90607	ILTR5K13	D7	7912	D7EA
SP447	2238	TR5	SP531	96621	ILTR6G8G	D7CA	7912	D7EA
SP448	90813	TR5AI-13	SP532	94769	ILZTR6A8G	D7RC	7912	D7EA
SP448	97287	ITR5H13	SP534	97177	LTR6CI-8	D7RP	5686	DR7EIX
SP449	3332	XR5	SP535	92182	LTR6BI-9	D7RTC	5629	DP7EA-9
SP450	6630	UR4	SP536	90156	ITR6G9	D7RTP	7803	DPR7EIX-9
SP450	6945	UR45	SP537	96588	LTR6DI-8	D8C	2120	D8EA
SP452	4652	WR4-1	SP539	91924	ILZNR8A7G	D8RC	2120	D8EA
SP459	3403	TR55GP	SP541	97287	ITR5H13	D8RP	6681	DR8EIX
SP461	2238	TR5	SP541A	97287	ITR5H13	D8RTC	5829	DP8EA-9
SP466	6410	B5ES	SP541-A	97287	ITR5H13	D8T	2120	D8EA
SP467	2685	FR4GP	SP548	90374	LTR6DP13	D8TC	5829	DP8EA-9
SP468	7090	BKR5EGP	SP549	2438	WR5	DK7RTC	3932	DCPR7E
SP469	2467	PTR5A-13	SP-413	3951	TR55	DK7RTP	6046	DCPR7EIX
SP470	3403	TR55GP	ZD11	97928	Y1037J	DK9RTC	2641	DCPR9E
SP471	3692	TR65IX	ZD12	97190	Y4002J	E4RTC	7823	BPR4HS
SP473	3212	B-6L	ZD13	97190	Y4002J	E4TC	3611	BP4HS
SP474	3212	B-6L	ZD15	5616	Y-408JS	E5C	4210	B5HS
SP476	3332	XR5	<b>MTD</b>			E5RTC	6222	BPR5HS
SP477	5858	XR4	759-3336	7938	BKR5E	E5T	4111	BP5HS
SP478	2467	PTR5A-13	951-10292	4008	BPR6ES SOLID	E5TC	4111	BP5HS
SP479	3403	TR55GP	<b>Torch</b>			E6C	3922	BR6HS
SP479	7397	TR5IX	.K5RTC	6130	BCPR5ES	E6C	7534	B6HS
SP479	97287	ITR5H13	.K5RTP	5688	BCPR5EIX	E6RC	3922	BR6HS
SP480	3210	B-4	.K5RTPP-11	2097	BCPR5EP-11	E6RTC	7022	BPR6HS
SP481	2438	WR5	.K5RTPPF-11	4588	PFR5A-11	E6RTP	4085	BPR6HIX
SP482	7159	TR55-1GP	.K5TC	6130	BCPR5ES	E6T	3611	BP4HS
SP485	2647	PFR5G-11	.K6RF	2330	BCPR6ES	E6TC	7331	BP6HS
SP486	3403	TR55GP	.K6RTC	2330	BCPR6ES	E7C	5110	B7HS
SP487	2467	PTR5A-13	.K6RTP	5689	BCPR6EIX	E7RTC	1503	BPR7HS BLYB
SP490	96870	ILTR6H8G	.K6RTPP-11	3350	BCPR6EP-11	E7RTC	6422	BPR7HS
SP491	3403	TR55GP	.K6RTPPF-11	4045	PFR6A-11	E7RTP	5944	BPR7HIX
SP492	4477	ITR6F13	.K7RTP	5690	BCPR7EIX	E7TC	6422	BPR7HS
SP493	3403	TR55GP	5580	7517	BUR6ET	E7TJC	7517	BUR6ET

**NOTE:** Cross references are provided as a GUIDE ONLY. Due to differences in design / materials, products produced by various mfrs may have different specifications. Please refer to specific application guide for proper usage.

**REMARQUE:** Les références sont fournies en GUIDE UNIQUEMENT. En raison des différences de conception et de matériaux, des produits fabriqués par différents fabricants peuvent avoir des spécifications différentes. Veuillez vous référer au guide d'application spécifique pour l'utilisation correcte.





Competitor #	NGK Stock #	NGK Part #	Competitor #	NGK Stock #	NGK Part #	Competitor #	NGK Stock #	NGK Part #
<b>Torch</b>			<b>Torch</b>					
E8C	4322	BR8HS	K6RT3PP-11	3271	PZFR6F-11			
E8RC	1466	BR8HS BLYB	K6RTC	6364	BKR6ES			
E8RC	4322	BR8HS	K6RTC11	5553	BKR6ES-11			
E8RTC	3725	BPR8HS	K6RTC-11	5553	BKR6ES-11			
E8TC	3725	BPR8HS	K6RTI	6418	BKR6EIX			
F5RF	1233	BPR5EY	K6RTIP	4589	IFR6T11			
F5RTC	6773	BPR5ES BLYB	K6RTJPP	5547	PFR6W-TG			
F5RTC	7734	BPR5ES	K6RTJY	7808	BKUR6ET			
F5RTP	6597	BPR5EIX	K6RTP	6418	BKR6EIX			
F5RTPP-11	3971	BPR5EP-11	K6RTPP	3500	PFR6B			
F6C	7432	B6ES	K6RTPP-11	5555	PFR6G-11			
F6REC4	4008	BPR6ES SOLID	K6RTPPF-11	2743	PFR6J-11			
F6RF	6427	BPR6EY	K6RTPPF-11	4014	PFR6B-11			
F6RTC	6775	BPR6ES BLYB	K6TC	5553	BKR6ES-11			
F6RTC	7131	BPR6ES	K7RT3PP-11	6855	ZFR7F-11			
F6RTI	6637	BPR6EIX	K7RTC	4952	BKR7ES-11			
F6RTJY	7517	BUR6ET	K7RTP	2667	BKR7EIX			
F6RTP	6637	BPR6EIX	K7RTPP-11	2380	PFR7G-11			
F6RTP	7084	BPR6EGP	K7TC	4952	BKR7ES-11			
F6T	7333	BP6ES	K7TJC	4563	BCP6ET			
F6TC	7333	BP6ES	KL6RTI	3656	LZFR6AI			
F7C	1111	B7ES	L7TC	7321	BPM7A			
F7RC	5122	BR7ES	LDKRTPP	4288	PLKR7A			
F7RTC	5534	BPR7ES	P6RTC	7773	UR6			
F7RTJC	1263	BP6ET	Q5RTC	2238	TR5			
F7RTP	4055	BPR7EIX	Q5RTP-11	7397	TR5IX			
F7TC	5534	BPR7ES	Q6RTC	3623	BPR6EFS			
F7TJC	1263	BP6ET	Q6RTP-11	3689	TR6IX			
F8C	5422	BR8ES	Q6RTPP-13	5598	PTR6D-13			
F8RC	3961	BR8ES SOLID	Q6TC	3623	BPR6EFS			
F8RC	5422	BR8ES	Q7RTP-11	3690	TR7IX			
F8RTC	3923	BPR8ES	QH5RTIP-13	90083	LTR5BI-13			
F8TC	3923	BPR8ES	QH5RTIP-13	90607	ILTR5K13			
G3F	3210	B-4	QH5RTPP-13	2467	PTR5A-13			
G4C	3210	B-4	R4C	2910	AB-6			
G5RC	3522	BR6S	R6C	2910	AB-6			
G6RC	3522	BR6S	R7	3010	AB-7			
K4RTC3	7558	ZFR5F	T5RTC	2438	WR5			
K5RF11	6953	BKR5E-11	Z4C	3112	B-4L			
K5RF-11	6953	BKR5E-11	Z4JC	3112	B-4L			
K5RT2PP-11	3440	BKR5EP-11	<b>Volvo Penta</b>					
K5RT3P-11	7098	ZFR5FGP	3851857	2238	TR5			
K5RT3PP-11	4363	PZFR5F-11	3851859	6630	UR4			
K5RTC	6130	BCPR5ES	3851861	6630	UR4			
K5RTC5	3459	ZFR5N	3851868	3754	TR4			
K5RTC11	2382	BKR5ES-11	3854399	2238	TR5			
K5RTC-11	2382	BKR5ES-11	3856759	2238	TR5			
K5RTM	6376	LFR5A-11	3858996	6579	PTR5F-11			
K5RTP	6341	BKR5EIX	3858997	6579	PTR5F-11			
K5RTPP-11	2647	PFR5G-11	3861632	6579	PTR5F-11			
K5RTPP-11	3440	BKR5EP-11	21452622	6579	PTR5F-11			
K5RTPP-11	5838	PFR5N-11						
K5RTPPF-11	2300	PFR5B-11						
K5RTPPF-11	4642	PFR5J-11						
K5RTSPP	7968	PZFR5D-11						
K5TC	2382	BKR5ES-11						
K5TC	6130	BCPR5ES						
K6RD	4959	BKR6EKC						
K6RDY	2288	BKR6EK						
K6RF	2330	BCPR6ES						
K6RF11	2756	BKR6E-11						
K6RF-11	2756	BKR6E-11						
K6RT2PP-11	2978	BKR6EP-11						
K6RT3P-11	7098	ZFR5FGP						

GUIDE ONLY

**NOTE:** Cross references are provided as a GUIDE ONLY. Due to differences in design / materials, products produced by various mfrs may have different specifications. Please refer to specific application guide for proper usage.

**448 NOTA:** El cruce de referencias servirá únicamente como guía. Las diferencias en diseño, materiales y los productos utilizados para su elaboración pueden variar dependiendo del fabricante. Para obtener la aplicación correcta de su vehículo, por favor referirse a la sección correspondiente dentro de esta guía.

## Stock Number to Part Number

NGK STK NO.	NGK PART NO.	NGK STK NO.	NGK PART NO.	NGK STK NO.	NGK PART NO.	NGK STK NO.	NGK PART NO.	NGK STK NO.	NGK PART NO.
127	SIFR6A11	1275	CR8E	2129	B7HS-10	2635	GR4	3180	BPZ8HS-15
372	ZNAR6AIX-11	1299	JR10B	2140	BP5ES Solid	2641	DCPR9E	3186	TR5GP
373	SILFR6B8	1311	DIFR5C11	2147	BUZHW	2647	PFR5G-11	3188	JR9B
701	BUHW S25	1312	DIFR6C11	2161	Y-115R1	2649	YE01	3194	BR9ES SOLID
702	BUHW-2 S25	1313	FR5EI	2168	C8HA	2667	BKR7EIX	3199	BKR6EQU
703	BU8H S25	1314	IFR6G-11K	2170	J9A	2668	BKR8EIX	3200	PGR7A
704	B7HS-10 S25	1402	SILKR8A-S	2173	BUZHW-2	2669	BKR9EIX	3207	UR45GP
705	B8HS-10 S25	1406	DILKAR7B11	2187	Y-118R	2683	TR55-1	3210	B-4
707	BR9HS-10 S25	1422	ILKR8E6	2202	DPR8EIX-9	2685	FR4GP	3212	B-6L
708	BR6FS S25	1445	BR7HS BLYB	2210	A6FS	2687	FR6EI	3226	Y-202-2
709	BR8HS-10 S25	1463	BR8ES SOLID BLYB	2211	C2H	2688	CR6EH-9	3228	C6HSA
710	BP8H-N-10 S25	1465	IZTR5B11	2215	BKR6EP-8	2689	BR9EG-N-8	3230	BR9EG
713	BR8ES S25	1466	BR8HS BLYB	2218	BPMR8Y	2707	BR9ECMIX	3235	R0045Q-9
714	BR9ES S25	1468	BR8HS-10 BLYB	2226	Y-401-3	2741	R6252K-105	3238	Y-709R
740	B2-LM S25	1469	BR9ES BLYB	2227	AP8FS	2743	PFR6J-11	3248	FR5GP
741	B-4LM S25	1470	BR9ES SOLID BLYB	2238	TR5	2746	R5670-6	3249	R5673-8
744	BM6A S25	1471	BR9EYA BLYB	2248	UR55	2756	BKR6E-11	3252	BR9ECM
747	BPM6A S25	1472	BR9HS-10 BLYB	2262	ZFR5F-11	2761	PFR5G-13E	3271	PZFR6F-11
748	BPM7A S25	1473	BU8H BLYB	2264	BPR2ES	2763	GR4GP	3306	BCPR5EIX-11
1006	BPR6EFS S25	1474	BUHW BLYB	2271	PFR5C-11	2765	Y-701RS	3320	G-2Z
1018	BPZ8H-N-10 S25	1475	BUHW-2 BLYB	2288	BKR6EK	2771	UR5	3322	BR4HS
1029	BPMR6A-10	1480	R0406A-8	2298	R5670-5	2773	R6061-11	3323	AR6FS
1034	BP7ES	1481	R0406A-9	2300	PFR5B-11	2815	TR4GP	3326	DR4HS
1041	ZFR6A-11	1482	CR7E BLYB	2305	CR9EKB	2817	R5673-7	3332	XR5
1049	B8EFS	1483	LF6CGP	2306	CPR8EA-9	2831	Y-809-1	3334	R5184-105
1052	B6HS-10	1488	CR7HSA BLYB	2308	CPR9EA-9	2842	PJR7A	3346	BR7EF
1065	Y-702R	1490	CR8E BLYB	2309	LF7AIX	2851	GR5	3350	BCPR6EP-11
1068	DP6EA-9	1491	CR9EB BLYB	2311	B7ES-11	2867	PFR5B-11B	3351	GR5GP
1085	B9EFS	1493	CR9EK BLYB	2313	LZTR4AIX-11	2869	UR4GP	3354	R5670-8
1086	BCP4ES-11	1503	BPR7HS BLYB	2314	LZTR5AIX-13	2877	B7ES SOLID	3365	CMR6H
1090	BR6HS-10	1505	BP8H-N-10 BLYB	2315	LZTR6AIX-13	2887	DPR5EA-9	3381	LZTR5AGP
1092	BP7HS-10	1506	BPZ8HS-10 BLYB	2316	DCPR9EIX	2890	BKR5EKUP	3388	R0373A-9
1094	BR7EFS	1507	BR6HS BLYB	2318	BR6FIX	2891	R5670-7	3403	TR55GP
1095	BCPR7ES-11	1508	BPR9ES BLYB	2322	BUE	2910	AB-6	3410	B-4LM
1097	BR4ES	1553	LKAR8BI9	2329	BR8EQ-14	2912	BP8ES	3419	BR6HIX
1098	BR7HS-10	1555	SIZKBR8A8HS	2330	BCPR6ES	2923	DR8ES-L	3430	B8EG
1107	BPZ8HS-10 S25	1582	CPR6EA-9S	2341	PFR6G-13E	2930	Y-117RS	3432	BPR4EY
1111	B7ES	1589	BPMR7Y	2359	BPR5EFS-13	2950	BCPR5EP-8	3437	DR9EA
1113	BR7HS-10 S25	1598	FR2B-D	2360	CR10EK	2953	YR5GP	3440	BKR5EP-11
1116	LF6A-11 S25	1633	LMAR9D-J	2380	PFR7G-11	2954	R6918B-9	3442	R5673-9
1119	LF6A-11 S25	1637	ILFR5B11	2382	BKR5ES-11	2966	Y-702U	3452	BKR6EKP-11
1132	Y-112RS1	1643	LKR7E	2391	BKR5E-N-11	2967	BM6FY BL1	3459	ZFR5N
1134	BR8HS-10	1654	ILZKAR7B11	2396	R6252E-105	2978	BKR6EP-11	3473	Y-924J
1147	B2-LM	1656	CMR7H-10	2397	BKUR6ET-10	2983	CR6HSA	3474	ILTR5B11
1157	BR8HCS-10	1671	BPR4ES-H	2399	B10HS	3006	BR10ECMIX	3478	CR8EK
1172	BKR5E S25	1675	PFR7S8EG	2405	R5673-6	3010	AB-7	3481	DCPR6E
1174	BMR4A S25	1679	LMAR6C-9	2411	B8ES	3020	AB-2	3486	CR7EH-9
1184	BMR6A S25	1682	DCPR7EGP	2420	D9EA	3035	BR8ECM	3500	PFR6B
1187	BPM7Y S25	1698	ZNAR6AGP	2422	BUH	3041	Y-706R	3508	IFR5T-8N
1194	BPMR6A S25	1716	CS6 S100	2430	CR4HSA	3066	CMR7H	3510	B6S
1195	BPMR7A S25	1959	PLFR6C-10G	2438	WR5	3072	FR45GP	3520	BR8ECMIX
1196	BPR2ES S25	1961	ILZKR7A	2441	BCPR5EY-11	3089	BR9EIX SOLID	3521	CR9EIX
1207	BR7HS S25	1989	ILKR7B8	2460	BKR5ES	3106	IGR7A-G	3522	BR6S
1208	ILZFR6D11	1997	R2556B-10	2467	PTR5A-13	3107	IFR5G-11K	3526	BP7EFS
1209	PTR4G-15	2000	R7282-10	2477	ZFR5FIX-11	3108	DPR6EB-9	3530	B9EG
1223	CMR6A	2015	BPR2ES SOLID	2489	BPR6EY BL1	3110	B-2	3546	PFR6N-11
1229	Y-107R	2031	Y-103V	2522	BUHX	3112	B-4L	3547	UR5GP
1232	Y-112TS	2086	CR8HSA	2526	BKR5EYA-11	3123	DR7ES	3573	PGR5A-11
1233	BPR5EY	2087	BKR5EYA	2531	Y-112M1	3129	BR9EQ-14	3579	BZ7HS-10
1239	Y-207T	2095	BKR7EKC-N	2532	Y-203	3130	BR8EG	3586	PZFR6J-11
1250	Y-208T	2097	BCPR5EP-11	2611	B9ES	3133	BPZ8HS-10	3587	PLTR6A-10G
1263	BP6ET	2101	BPM7Y BL1	2622	BUHW	3141	PFR6L-13	3588	ILFR6A
1266	BCPR5EY	2115	BPR5EIX-11	2623	BPR6FS	3142	GR45GP	3611	BP4HS
1270	BPMR6F	2120	D8EA	2630	BP8HS	3147	BM7Y BL1	3623	BPR6EFS
1273	BCPR5E-11	2127	AP7FS	2633	BPR6HS-10	3177	BR6EF	3626	B9HS-10



# Stock Number to Part Number

THE IGNITION SPECIALIST™

NGK STK NO.	NGK PART NO.	NGK STK NO.	NGK PART NO.	NGK STK NO.	NGK PART NO.	NGK STK NO.	NGK PART NO.	NGK STK NO.	NGK PART NO.
3630	B10EG	4013	BMR2A SOLID	4469	LF95AIX-11	4894	R7434-10	5266	IZFR6K-11S
3641	PKR7A	4014	PFR6B-11	4471	LKR8AP	4897	R7435-10	5275	BCPR6EP-N-8
3653	IMR8C-9H	4015	BR9EG SOLID	4477	ITR6F13	4901	R7437-8	5281	R2525-10
3656	LZFR6AI	4017	R6601-10	4482	R6725-115	4904	ILFR6T11	5306	LZTR4A-11
3657	IZFR5K11	4018	Y-757RS	4492	R6918B-8	4905	R7438-8	5326	Y-874-1
3664	BPR5EY BL1	4043	ZFR4F-11	4495	BPZ8H-N-10	4908	LMAR7A-9	5329	DPR9EA-9
3672	LFR6A-11	4045	PFR6A-11	4497	BCPR6EP-N-11	4912	ILKAR7B11	5344	IFR6D10
3678	IFR6L11	4050	R5673-10	4522	BR9HS	4919	BCPR6EIX-11	5367	ILTR6B11
3683	B8ES SOLID	4055	BPR7EIX	4536	XR45	4921	BPM7Y	5368	IFR6B11
3686	FR45	4074	R6061-9	4548	CR9EK	4922	BR6ES	5370	BUR4EB-11
3689	TR6IX	4076	R6254K-105	4549	CR7HSA	4929	DPR8EA-9	5392	Y-720U1
3690	TR7IX	4080	IZFR5B	4551	BR9HS-10	4930	BCP6ES	5393	BKR5E BL1
3691	TR8IX	4085	BPR6HIX	4554	R671A-8	4936	ZFR5D-11	5395	BPMR8Y BL1
3692	TR65IX	4091	R5671A-7	4562	BPM6Y	4937	Y-707RS	5414	BPMR6Y BL1
3692	TR65IX	4095	IZFR6F11	4563	BCP6ET	4940	R0373A-10	5422	BR8ES
3696	BKR6EY	4110	B-4H	4573	Y-204RS	4948	CR8EIB-10	5423	DR8ES
3704	Y-918J	4111	BP5HS	4578	CR7E	4952	BKR7ES-11	5424	BKR4E-11
3710	B7S	4115	PFR6G-13	4586	R6601-11	4959	BKR6EKC	5438	BR9ECSIX
3716	TR5-1GP	4122	BR7HS	4588	PFR5A-11	4962	R2556B-9	5442	R7376-8
3720	BCPR6EY-11	4129	B4ES	4589	IFR6T11	4968	TR6AP-13E	5459	PFR5L-11
3722	BR5HS	4133	BR4-LM	4623	DR5HS	4983	DCPR7E-N-10	5463	FR5AP-11
3725	BPR8HS	4143	Y-766MS	4626	BPMR7A	4984	PGR6A	5464	BKR5EIX-11
3735	BCPR6E	4146	B2LMY BL1	4629	C7HSA	4985	R7282-105	5466	BM6Y BL1
3741	PZFR5F	4172	BR8ECS	4632	BPR6HSA	4996	IFR5T11	5468	SILFR6A11
3754	TR4	4177	TR6	4639	PFR6L-11	4997	PLZTR4A-13	5469	DR7EB
3764	BKR6EIX-11	4179	DCPR8E SOLID	4641	CMR7A-5	4998	PLZTR5A-13	5474	CMR4A
3782	Y-703R	4210	B5HS	4642	PFR5J-11	5011	BP4HS-10	5476	ILTR5D
3784	PTR5D-10	4212	ILFR6G-E	4644	BKR7E	5017	LZTR4AGP	5477	KR8AI
3785	BPR7ES SOLID	4213	IZTR4A11	4646	Y-314	5018	LF95AGP	5496	BKUR7ET
3787	ILTR6A-8G	4214	IZFR7M	4652	WR4-1	5019	LTR5GP	5501	R7420-10
3797	CR8EHIX-9	4216	R0045Q-10	4654	R7437-9	5024	BPR4HS-10	5507	PZNR6A11H
3810	B8S	4218	CR8EIX	4656	R7438-9	5030	BCP7ES	5509	BCPR7ET
3823	BP8HS-10	4224	BPR4ES-11	4660	R7433-9	5034	R5674-7	5510	B8HS
3824	BR6ES-11	4226	BMR7A	4663	CR7EB	5044	BR8EIX	5526	BUHXW-1
3829	Y-204TS1	4234	BR10ECM	4677	BR9ECS	5066	DIMR8A10	5531	DPR6EA-9
3830	BR10EG	4253	PZFR7G-G	4684	BR10ES SOLID	5068	IFR8H11	5534	BPR7ES
3841	BR2-LM SOLID	4259	PMR7A	4690	BUR6EA-11	5077	ZGR5A	5539	BR8HSA
3857	R6725-105	4268	GR45	4693	Y-716RS	5084	ZFR5A-11	5542	PFR6T-10G
3901	CPR7EA-9	4282	R7440A-10L	4695	CR4HSB	5096	C7E	5545	DPR9EIX-9
3903	BPR6EIX-11	4285	BKR7EQUP	4696	IFR5D10	5107	LZTR7AIX-13	5547	PFR6W-TG
3913	R5670-9	4286	CR8EIA-9	4705	Y-745U	5110	B7HS	5553	BKR6ES-11
3922	BR6HS	4288	PLKR7A	4706	MAR10A-J	5111	BP7HS	5555	PFR6G-11
3923	BPR8ES	4291	ZFR6F-11	4708	CR8EIA-10	5113	BPMR4A SOLID	5566	R0373A-11
3932	DCPR7E	4292	PFR5R-11	4709	FR9B1-11	5114	IFR7L11	5568	Y-930U
3949	R6254E-105	4293	BKR6EZB	4717	PMR9B	5115	IFR7F-4D	5574	BPM8Y SOLID
3951	TR55	4294	IZFR6H11	4730	DPR8Z	5118	PLZKAR6A-11	5581	ILTR5C11
3961	BR8ES SOLID	4296	BR6HSA	4735	R2525-9	5122	BR7ES	5583	R6254E-9
3964	BKR5EKU	4302	BKR5EKP-11	4739	BM4Y BL1	5123	DR8HS	5584	ZFR5J-11
3967	BKR5EKB-11	4306	LZTR5A-13	4742	KR8DI	5126	B8HS-10	5585	ZFR6J-11
3971	BPR5EP-11	4311	R6725-11	4757	IZFR6N-E	5129	DPR7EA-9	5592	PFR7W-TG
3973	Y-724U	4313	LMAR8A-9	4764	BUR7EQP	5139	JR8C	5598	PTR6D-13
3978	PFR7H-10	4322	BR8HS	4772	DR9EIX	5141	TR6GP	5599	ITR4A15
3981	BR9EIX	4323	BR6FS	4776	BKR7E-E	5146	PTR4B-15	5616	Y-408JS
3992	BR8EG SOLID	4339	DCPR8E	4778	R0161-10	5149	PLKR6A	5626	BUHW-2
3993	BR10EG SOLID	4344	LTR5IX-11	4786	LKAR8A-9	5155	FR4	5628	BM4A
3994	BP8ES SOLID	4363	PZFR5F-11	4793	PFR6G	5162	Y-113V	5629	DP7EA-9
3995	BP7ES SOLID	4374	CR8EKB	4823	DR6HS	5196	R6918C-9	5632	BCPR6E-11
3997	B8EG SOLID	4421	BKR4E	4830	DPR9Z	5214	LKR8A	5643	BKR5ESA-11
3998	B9EG SOLID	4435	ZFR5E-11	4832	BR10ES	5224	B10EGP	5648	IFR6Q-G
4000	BM4A SOLID	4449	R5674-6	4838	BP8H-N-10	5238	R5671A-9	5649	BKR6EKE
4002	BMR6A SOLID	4452	BMR2A-10	4853	PFR7B	5245	ILFR7H	5657	R5674-8
4004	BMR4A SOLID	4455	CR7EKB	4855	DR8EB	5246	CMR4H	5666	CR8EH-9
4006	BPR5ES SOLID	4457	R7376-10	4857	R7420-105	5255	BUR9EQP	5684	TR45-1GP
4007	BP6ES SOLID	4458	ILFR6J-11K	4867	IFR6B-K	5258	CR8EIB-9	5685	BPR5EKU
4008	BPR6ES SOLID	4462	IZFR6J	4888	IMR9B-9H	5264	Y-711J	5686	DR7EIX

## Stock Number to Part Number

NGK STK NO.	NGK PART NO.	NGK STK NO.	NGK PART NO.	NGK STK NO.	NGK PART NO.	NGK STK NO.	NGK PART NO.	NGK STK NO.	NGK PART NO.
5687	BR9HIX	6193	JR9C	6596	R5671A-11	6817	LMAR8A-9S	7164	TR55IX
5688	BCPR5EIX	6198	Y-752M	6597	BPR5EIX	6821	C8HSA	7168	DCPR8EKC
5689	BCPR6EIX	6205	LKAR9BI9	6600	Y-543J	6825	Y-110	7173	R5672A-8
5690	BCPR7EIX	6208	LR8B	6607	CPR8EB-9	6832	BUR7EB-11	7177	UR5IX
5691	BCPR7EIX-11	6213	SILMAR9A9S	6612	BR8ET	6839	R2349-10	7189	XR4IX
5693	BKR4EIX	6215	SILZKR6B11	6615	BR7ES SOLID	6853	BPR9EIX	7210	BCP6ES-11
5712	C-50	6216	CR9EHIX-9	6619	LFMR6AIX-11	6855	ZFR7F-11	7214	GR5IX
5722	BR9ES	6221	BM6F	6625	Y-107-1	6858	DFH6B-11A	7222	BPR4ES
5724	BKR6E-N-11	6222	BPR5HS	6628	Y-107V	6869	MAR9A-J	7223	CR7HS
5727	YA01	6240	PLFR5A-11	6629	DP9EA-9	6876	PZFR6F	7226	BPR7ES-11
5728	BMR4A	6244	Y-306R	6630	UR4	6884	LMAR9E-J	7238	Y-301V
5740	Y-925J	6259	R6918B-7	6637	BPR6EIX	6899	CPR6EA-9	7240	YR55
5757	PFR6X-11	6261	BPR6EY-11	6644	PTR5D-13	6900	Y-719RS1	7243	TR5-1IX
5760	PGR5C-11	6262	BCPR6EY-N-11	6664	BR7EIX	6914	ZMR7AP	7252	FR5-1
5766	IMR9C-9HES	6263	CR9E	6668	LFMR6A	6917	BUR7EQ	7272	UR55IX
5767	BKR6EQUA	6264	CR10E	6669	BR9ECS-5	6925	Y-122	7274	CR6HIX
5777	BUR9EQ	6282	BCPR7ES	6681	DR8EIX	6926	Y-106V	7293	XR45IX
5787	ILZKR7B-11S	6289	CR9EIA-9	6684	BPR8EIX	6928	BP4ES	7300	TR4IX
5791	BKR7E-11	6290	PFR6H-10	6689	CR5EH-9	6929	Y-810	7316	TR55-1IX
5794	IFR7F-8DS	6292	BKR6EKUE	6692	BR10HIX	6931	BR6EB-L-11	7317	R5724-8
5798	BR2-LM	6325	Y-103K	6696	BCPR5ES-11	6937	BPR5EY-11	7321	BPM7A
5809	TR6AP-13	6326	BP6HS-10	6700	RE7C-L	6945	UR45	7327	BP5EY
5810	B9HS	6328	BPMR4A-10	6701	RE9B-T	6953	BKR5E-11	7331	BP6HS
5812	CM-6	6334	ZGR5C	6702	R5674-10	6955	CR9EB	7333	BP6ES
5820	R5671A-10	6341	BKR5EIX	6703	BPMR7A SOLID	6957	BR10EIX SOLID	7334	BP6ES-11
5829	DP8EA-9	6364	BKR6ES	6706	LKAR8AI-9	6962	BKR6E	7348	UR6IX
5838	PFR5N-11	6371	FR5AP-10	6715	BR8HS Solid	6965	CR6E	7355	XR5IX
5847	LKR7B-9	6376	LFMR5A-11	6719	BKR5E BLYB	6966	IMR9A-9H	7373	FR5
5851	PMR8A	6378	PMR8B	6720	BM6F BLYB	6985	CR8EKPA	7385	CR7EIX
5858	XR4	6410	B5ES	6726	BPMR6A	6987	ZFR6F-11G	7390	BKR5EY
5861	R0045J-9	6418	BKR6EIX	6729	BP8HS-15	6988	BKR7EIX-11	7397	TR5IX
5866	BR5ES	6419	CR9EHI-9	6735	BUR5EB-11	6992	BKUR6ETB	7401	UR4IX
5869	ER9EH	6421	BM7F	6737	PZFR5Q-11	6993	BKR6EIKU	7405	R5672A-9
5874	PFR6U-11G	6422	BPR7HS	6740	PFR6W-T	6994	IZFR6K11	7411	CPR8E
5877	BR7ET	6425	Y-104	6741	IFR6E11	6997	CR8E S25	7415	DCPR8EKP
5881	BKR7EIKU	6427	BPR6EY	6742	BPR8HIX	7001	BR8HIX	7418	IFR5J11
5886	BR8ECSIX	6431	BU8H	6743	BMR4A BLYB	7021	BPM6A	7421	BMR6A
5887	IZFR5G	6441	ZFR6FIX-11	6744	TR45-1IX	7022	BPR6HS	7432	B6ES
5899	IZFR5J	6448	R7420-9	6744	TR45-1IX	7023	CR6HS	7444	J10A
5909	Y-732J	6453	R2556B-8	6745	BKR5EY-11	7031	BUR7EA-11	7447	BUZ8H
5913	ZFR7F	6458	PFR6Q	6746	BM7A BLYB	7037	BUR6EB-11	7464	Y-701R
5921	BM6A	6468	R5674-9	6747	BR8EIX SOLID	7043	R0045J-11	7465	Y-119V
5927	B10EGV	6481	ILFR6B	6748	IZFR6K-11E	7052	YR5	7467	Y-271-2
5928	BPM4A	6482	CR10EIX	6749	BPMR6A BLYB	7060	TR5-1	7471	C8E
5940	BR10ECS SOLID	6490	LFMR6D	6753	BPM6F BLYB	7067	BR7HIX	7472	BPM7A SOLID
5944	BPR7HIX	6499	LFMR4A-E	6757	BPR6EKN	7082	BPR5EGP	7473	C8EH-9
5946	LMAR6A-9	6500	CR6HSB	6759	BPMR6A BLYB	7084	BPR6EGP	7492	Y-146R
5950	BPM6F	6501	IMR9C-9HE	6761	BPMR7A BLYB	7086	BCPR5EGP	7493	Y-147T
5957	R0045Q-11	6502	IFR5L11	6763	BPMR8Y BLYB	7088	BCPR6EGP	7496	BCP5ES
5958	CPR6EB-9	6507	IFR6B	6766	Y-149	7090	BKR5EGP	7499	C9E
5960	ZFR6T-11G	6508	CPR9EB-9	6770	BPR2ES BLYB	7092	BKR6EGP	7502	CR9EH-9
5962	R6061-10	6509	LTR6IX-11	6773	BPR5ES BLYB	7094	ZFR6AGP	7505	SILFR6C11
5984	BR9ES S25 SOLID	6510	LTR7IX-11	6774	IZFR6K13	7096	ZFR5EGP	7506	R0465B-10
5987	PLZFR6A-11S	6512	D6HA	6775	BPR6ES BLYB	7098	ZFR5FGP	7510	WR5IX
6014	BR9ECSIX-5	6521	BM7A	6776	CMR5H BLYB	7100	ZFR6FGP	7512	D6EA
6021	BM6A SOLID	6525	Y-106-1	6777	IMR9C-9H	7102	ZGR5AGP	7516	YR5IX
6026	BPM6A-10	6528	Y-114T	6778	CMR6H BLYB	7112	D8HA	7517	BUR6ET
6043	ILZKAR7A10	6535	CR5HSB	6779	BCPR6ES-11	7120	CR5HIX	7526	BP9ES
6046	DCPR7EIX	6544	IMR9D-9H	6784	CMR7A BLYB	7125	Y-154	7532	BPR5EA-L-11
6125	Y-103	6546	DCPR8EIX	6785	CMR7H BLYB	7131	BPR6ES	7534	B6HS
6130	BCPR5ES	6569	FR5AP-11E	6786	CR5HSB BLYB	7133	BPR6ES-11	7543	CMR7A
6150	B4LMY BL1	6578	BPR4ES SOLID	6787	BR2-LM BLYB	7148	B9ES SOLID	7544	CR7HIX
6159	DILFR5C11D	6579	PTR5F-11	6799	ILZKAR7A	7159	TR55-1GP	7546	CR7EK
6176	DILFR6D11	6588	IFR9H11	6801	BR10EIX	7162	DR8EA	7548	BR9EYA





# Stock Number to Part Number

THE IGNITION SPECIALIST™

NGK STK NO.	NGK PART NO.	NGK STK NO.	NGK PART NO.	NGK STK NO.	NGK PART NO.	NGK STK NO.	NGK PART NO.	NGK STK NO.	NGK PART NO.
7554	ZNAR7AIX	7968	PZFR5D-11	91568	SILZKR6D8E	93482	SILZKAR7B11	95710	DILZKR7B11GS
7556	IMR9E-9HES	7969	BKR6EKUB	91578	DILKAR7G11GS	93501	LKAR7BIX-11S	95712	LZFR6AP11GS
7558	ZFR5F	7986	BR8ES-11	91712	Y-510R	93580	PFR7N8DS	95741	CMR8H
7559	UR45IX	7990	BKR6EYA	91715	IKR7H8	93593	SILZNAR8C7H	95746	R8102B-10
7563	IZKR7B	7993	R5724-10	91725	LTR6BI-13	93618	SIKR9A7	95770	ILZKBR7B8DG
7588	YR55IX	7994	IFR5E11	91784	LKAR8BHX	93623	IFR7U-4D	95822	ILTR7N8
7599	CMR5H	8196	DCPR6EIX	91909	LMAR8BI-9	93655	SILZKR7E8EG	95830	LKAR6AGP
7612	B6LY BL1	8201	ER8EHIX	91924	ILZNAR8A7G	93675	SILMAR7A9S	95839	FR5AHX
7613	BR10EYA	8756	Y-608J	91961	DILFR7K9G	93759	DILFR5A11	95853	LTR6AI13
7634	BPR5ES-11	8765	MAR8B-JDS	91970	ILNAR8B7G	93763	LKR6BHX-E	95875	SILZKFR8D7S
7654	PLFR6A-11	8926	Y1002AS	91975	R2556G-8	93815	SILZKR6B10E	95884	MR9F
7658	IFR6J11	9029	DILKAR6A11	92038	LFR7A	93819	ILKR8Q7	95897	MR7F
7669	CR8HIX	9198	CPR7EAIX-9	92041	ZFR5AP	93833	LMAR8C-9	95945	LFR5A-11 BLYB
7677	BMR2A	9356	R0451B-8	92053	CZ159	93858	TR5BP12	95983	LKR7BGP-8
7679	BR9EYA S25	9723	SILZKR7B11	92085	IFR6V-10G	93893	LFR6AIX	96002	LKR6BGP-E
7692	MR8AI9	9810	CZ104	92145	LZFR5CI-11	93911	LKR7AIX	96024	ILKAR8H6
7696	PZFR6H	9970	CZ303	92174	LZFR5C-11	93961	LKAR7C-9	96329	ILTR5L11
7727	BP6EY	90046	Y1033AS	92182	LTR6BI-9	94017	LZKR6AGP-E	96355	LFR5AHX
7728	Y-203V	90074	DILZKR7A11DS	92213	ZFR6BGP-S	94021	LZMAR8AI-10	96358	LKR7AHX-S
7732	BP5ES-11	90083	LTR5BI-13	92217	DILKAR7B8	94051	SILZNAR6D9	96361	PMR8C-H
7734	BPR5ES	90117	ILTR6E11	92222	LMAR9G	94122	LFR6AHX-S	96412	ILZKR7D8
7740	PTR5C-13	90137	DILZKAR7C11S	92238	DCPR8E BLYB	94124	ILKAR7L11	96416	IFR6F8DN
7743	PZFR5J-11	90156	ITR6G9	92264	SPMR8A6HDG	94167	DIFR6D13	96457	FR5BHX
7746	IFR7G-11KS	90174	DF8H-11B	92274	LKAR7AHX-S	94201	SILZKGR8B8S	96509	ILZKAR7E11S
7751	ILZKR7B11	90178	ZGR5A-4	92288	LMAR8AI-8	94279	FR6AHX-S	96530	DCPR6E BLYB
7755	BKR4ESA-11	90192	LZFR5AGP-E	92315	SILZKR7E11	94290	ILZKR8A	96588	LTR6DI-8
7756	R7420-11	90198	LTR6GP	92340	CZ551	94372	LTR6GP-8	96621	ILTR6G8G
7763	R7376-9	90220	LTR5AHX	92373	SILFR5A11	94374	LTR6IX	96652	ER9EHIX
7764	SILMAR10A9S	90223	PLZKBR7B8DG	92375	FR5AHX-E	94407	ZFR5FGP-E	96779	ILFR5T11
7772	PFR7G-11S	90299	MR8F	92400	FR7BHX-S	94460	PFR8S8EG	96780	LTR6AI-9
7773	UR6	90318	ZFR6U-9	92459	ZFR5FGP-8E	94489	ILTR6M9G	96807	ZFR5FIX-11E
7781	ZFR5LP-13G	90374	LTR6DP13	92460	LZFR5AIX-11E	94553	ZFR5AIX-11	96830	ZFR5F-4
7784	CR8EB	90410	LKR6E-9N	92482	DPR6EA-9 BLYB	94567	TR5AHX	96870	ILTR6H8G
7785	CR9EKPA	90465	LKR8BHX-S	92491	DILFR6J11	94698	ILMAR7E9	96956	LMAR7DI-10
7787	LFR6C-11	90495	LTR6BHX	92566	ZFR6K-9E	94702	DF6H-11A	96957	DILKTR7B6
7788	BPR9ES	90537	LFR6A-11 BLYB	92579	CR9EIB-9	94705	LKR7BHX	96964	DILKAR7H11GS
7790	PZFR6E-11	90543	ILTR7E9	92605	DILFR5E11	94716	PLKR7B8E	96987	SILZKBR8E8S
7791	R0409B-8	90607	ILTR5K13	92628	BPM8Y S25 SOLID	94731	DILKTR7C11	97058	DR8EA BLYB
7795	KR9CI	90654	SILZKFR8E7S	92649	LKAR7BGP-S	94769	ILZTR6A8G	97100	TR4BHX
7797	BKR5EK	90656	ILTR6F9	92650	LKR6E	94806	LTR6BP13	97138	ZFR6AIX-11S
7803	DPR7EIX-9	90760	ZFR6F-11 BLYB	92714	TR6AHX	94833	PLFER7A8EG	97177	LTR6CI-8
7808	BKUR6ET	90804	ZFR5BGP	92743	DIMR8C10	94841	GR9A-EG	97190	Y4002J
7823	BPR4HS	90813	TR5AI-13	92838	TR5C-12	94862	LTR7CP13	97218	DILFR7B10G
7829	BP7HS-10	90856	IZFR7M6D	92873	LZKR6AIX	94931	LR4C-E	97225	LMAR9AI-8
7832	BP5ES	90882	ILTR5M9G	92873	LZKR6AIX	94940	ILKAR7C10	97226	BPR4ES BLYB
7834	BP5EA-L	90893	KR9C-G	92924	DILZKR7A11G	95112	ILZKAR8H8S	97287	ITR5H13
7839	DR7EA	90894	LMAR8F-9	93026	DILKAR8A8	95125	LFER7BHX	97292	LKAR6AHX
7840	CR5HSA	90935	DILZKAR7B11	93053	ILKR7E6	95159	FR6BHX-S	97312	ILKR9Q7G
7854	IFR5G11	90982	MR7BI-8	93126	LKR6CIX	95236	BPR10EIX	97382	GR4IX
7862	PZTR5A-15	90992	SILMAR8A9S	93135	DILKR7A11	95248	SILZKGR8C8S	97390	LKR7BGP-S
7866	IFR5N10	91039	IFR7X7G	93175	LKR7DIX-11S	95264	DILKR6D11G	97408	LZTR6AP11EG
7880	Y-710J	91064	SIMR8A9	93188	LMAR9AI-10	95275	Y-546J	97506	SILZKBR8D8S
7891	R5724-9	91175	CR7EIA-9	93199	DILKR6C11	95332	ZFR5FIX-E	97537	R2558E-9
7901	IJR7A9	91185	R2556G-10	93220	LKAR7AGP-D	95350	DILZKR7B11G	97606	PLZFR5B13EG
7909	AB-8	91187	LKAR6AIX-11	93226	KR9E-G	95369	SILTR6A7G	97627	Y1021J
7910	B6ES-11	91215	DILKAR7C9H	93227	SILNAR7B7	95371	LKAR9BI-10	97768	DPR8EA-9 BLYB
7912	D7EA	91234	IZFR6Q	93253	R2556G-9	95372	CR7HSA-9	97788	Y1032AS
7913	SILFR6A	91276	LTR6AHX	93298	LZFR5BI-11	95397	IMR8E-9HES	97928	Y1037J
7928	B10ES	91320	DPR7EA-9 BLYB	93322	PFR7AB	95399	SILMAR9B9	97932	IZFR5L11
7938	BKR5E	91356	LKR6AHX	93411	SILZKR7B8E	95605	LTR7BHX	98376	DILFR5A-11D
7942	R5672A-10	91360	MR8BI-8	93420	LFR6BHX	95609	IFR6Z7G		
7963	PFR7Q	91418	ILTR5E11	93427	BPR8ES-6	95627	LMAR8G		
7966	UR6GP	91448	DILKR8B6	93444	LMAR8D-J	95660	ILZKAR8J8SY		
7967	CR6EIA-9	91467	SILZKR7E9G	93476	SILZKAR7E8S	95705	SILKR8B8DS		



## Part Number to Stock Number

NGK PART NO.	NGK STK NO.	NGK PART NO.	NGK STK NO.	NGK PART NO.	NGK STK NO.	NGK PART NO.	NGK STK NO.	NGK PART NO.	NGK STK NO.
A6FS	2210	BCPR5EIX-11	3306	BKR6EQUA	5767	BP7ES	1034	BPR5ES BLYB	6773
AB-2	3020	BCPR5EP-11	2097	BKR6EQUP	3199	BP7ES SOLID	3995	BPR5ES SOLID	4006
AB-6	2910	BCPR5EP-8	2950	BKR6ES	6364	BP7HS	5111	BPR5ES-11	7634
AB-7	3010	BCPR5ES	6130	BKR6ES-11	5553	BP7HS-10	7829	BPR5EY	1233
AB-8	7909	BCPR5ES-11	6696	BKR6EY	3696	BP8ES	2912	BPR5EY BL1	3664
AP7FS	2127	BCPR5EY	1266	BKR6EYA	7990	BP8ES SOLID	3994	BPR5EY-11	6937
AP8FS	2227	BCPR5EY-11	2441	BKR6EZB	4293	BP8H-N-10	4838	BPR5HS	6222
AR6FS	3323	BCPR6E	3735	BKR7E	4644	BP8H-N-10 BLYB	1505	BPR6EFS	3623
B10EG	3630	BCPR6E-11	5632	BKR7E-11	5791	BP8H-N-10 S25	710	BPR6EFS S25	1006
B10EGP	5224	BCPR6EGP	7088	BKR7E-E	4776	BP8HS	2630	BPR6EGP	7084
B10EGV	5927	BCPR6EIX	5689	BKR7EIX	2667	BP8HS-10	3823	BPR6EIX	6637
B10ES	7928	BCPR6EIX-11	4919	BKR7EIX-11	6988	BP8HS-15	6729	BPR6EIX-11	3903
B10HS	2399	BCPR6EP-11	3350	BKR7EKC-N	2095	BP9ES	7526	BPR6EKN	6757
B-2	3110	BCPR6EP-N-11	4497	BKR7EKU	5881	BPM4A	5928	BPR6ES	7131
B2-LM	1147	BCPR6EP-N-8	5275	BKR7EQUP	4285	BPM6A	7021	BPR6ES BLYB	6775
B2-LM S25	740	BCPR6ES	2330	BKR7ES-11	4952	BPM6A S25	747	BPR6ES SOLID	4008
B2LMY BL1	4146	BCPR6ES-11	6779	BKR8EIX	2668	BPM6A-10	6026	BPR6ES-11	7133
B-4	3210	BCPR6EY-11	3720	BKR9EIX	2669	BPM6F	5950	BPR6EY	6427
B4ES	4129	BCPR6EY-N-11	6262	BKUR6ET	7808	BPM6F BLYB	6753	BPR6EY BL1	2489
B-4H	4110	BCPR7EIX	5690	BKUR6ET-10	2397	BPM6Y	4562	BPR6EY-11	6261
B-4L	3112	BCPR7EIX-11	5691	BKUR6ETB	6992	BPM7A	7321	BPR6FS	2623
B-4LM	3410	BCPR7ES	6282	BKUR7ET	5496	BPM7A S25	748	BPR6HIX	4085
B-4LM S25	741	BCPR7ES-11	1095	BM4A	5628	BPM7A SOLID	7472	BPR6HS	7022
B4LMY BL1	6150	BCPR7ET	5509	BM4A SOLID	4000	BPM7Y	4921	BPR6HS-10	2633
B5ES	6410	BKR4E	4421	BM4Y BL1	4739	BPM7Y BL1	2101	BPR6HSA	4632
B5HS	4210	BKR4E-11	5424	BM6A	5921	BPM7Y S25	1187	BPR7EIX	4055
B6ES	7432	BKR4EIX	5693	BM6A S25	744	BPM8Y S25 SOLID	92628	BPR7ES	5534
B6ES-11	7910	BKR4ESA-11	7755	BM6A SOLID	6021	BPM8Y SOLID	5574	BPR7ES SOLID	3785
B6HS	7534	BKR5E	7938	BM6F	6221	BPMR4A SOLID	5113	BPR7ES-11	7226
B6HS-10	1052	BKR5E BL1	5393	BM6F BLYB	6720	BPMR4A-10	6328	BPR7HIX	5944
B-6L	3212	BKR5E BLYB	6719	BM6FY BL1	2967	BPMR6A	6726	BPR7HS	6422
B6LY BL1	7612	BKR5E S25	1172	BM6Y BL1	5466	BPMR6A BLYB	6759	BPR7HS BLYB	1503
B6S	3510	BKR5E-11	6953	BM7A	6521	BPMR6A S25	1194	BPR7HS-10	1092
B7ES	1111	BKR5EGP	7090	BM7A BLYB	6746	BPMR6A-10	1029	BPR8EIX	6684
B7ES SOLID	2877	BKR5EIX	6341	BM7F	6421	BPMR6F	1270	BPR8ES	3923
B7ES-11	2311	BKR5EIX-11	5464	BM7Y BL1	3147	BPMR6Y BL1	5414	BPR8ES-6	93427
B7HS	5110	BKR5EK	7797	BMR2A	7677	BPMR7A	4626	BPR8HIX	6742
B7HS-10	2129	BKR5EKB-11	3967	BMR2A SOLID	4013	BPMR7A BLYB	6761	BPR8HS	3725
B7HS-10 S25	704	BKR5EKP-11	4302	BMR2A-10	4452	BPMR7A S25	1195	BPR9EIX	6853
B7S	3710	BKR5EKU	3964	BMR4A	5728	BPMR7A SOLID	6703	BPR9ES	7788
B8EFS	1049	BKR5EKUP	2890	BMR4A BLYB	6743	BPMR7Y	1589	BPR9ES BLYB	1508
B8EG	3430	BKR5E-N-11	2391	BMR4A S25	1174	BPMR8Y	2218	BPZ8H-N-10	4495
B8EG SOLID	3997	BKR5EP-11	3440	BMR4A SOLID	4004	BPMR8Y BL1	5395	BPZ8H-N-10 S25	1018
B8ES	2411	BKR5ES	2460	BMR6A	7421	BPMR8Y BLYB	6763	BPZ8HS-10	3133
B8ES SOLID	3683	BKR5ES-11	2382	BMR6A BLYB	6749	BPR10EIX	95236	BPZ8HS-10 BLYB	1506
B8HS	5510	BKR5ESA-11	5643	BMR6A S25	1184	BPR2ES	2264	BPZ8HS-10 S25	1107
B8HS-10	5126	BKR5EY	7390	BMR6A SOLID	4002	BPR2ES BLYB	6770	BPZ8HS-15	3180
B8HS-10 S25	705	BKR5EY-11	6745	BMR7A	4226	BPR2ES S25	1196	BR10ECM	4234
B8S	3810	BKR5EYA	2087	BP4ES	6928	BPR2ES SOLID	2015	BR10ECMIX	3006
B9EFS	1085	BKR5EYA-11	2526	BP4HS	3611	BPR4ES	7222	BR10ECS SOLID	5940
B9EG	3530	BKR6E	6962	BP4HS-10	5011	BPR4ES BLYB	97226	BR10EG	3830
B9EG SOLID	3998	BKR6E-11	2756	BP5EA-L	7834	BPR4ES SOLID	6578	BR10EG SOLID	3993
B9ES	2611	BKR6EGP	7092	BP5ES	7832	BPR4ES-11	4224	BR10EIX	6801
B9ES SOLID	7148	BKR6EIX	6418	BP5ES Solid	2140	BPR4ES-H	1671	BR10EIX SOLID	6957
B9HS	5810	BKR6EIX-11	3764	BP5ES-11	7732	BPR4EY	3432	BR10ES	4832
B9HS-10	3626	BKR6EK	2288	BP5EY	7327	BPR4HS	7823	BR10ES SOLID	4684
BCP4ES-11	1086	BKR6EKC	4959	BP5HS	4111	BPR4HS-10	5024	BR10EYA	7613
BCP5ES	7496	BKR6EKE	5649	BP6ES	7333	BPR5EA-L-11	7532	BR10HIX	6692
BCP6ES	4930	BKR6EKP-11	3452	BP6ES SOLID	4007	BPR5EFS-13	2359	BR2-LM	5798
BCP6ES-11	7210	BKR6EKU	6993	BP6ES-11	7334	BPR5EGP	7082	BR2-LM BLYB	6787
BCP6ET	4563	BKR6EKUB	7969	BP6ET	1263	BPR5EIX	6597	BR2-LM SOLID	3841
BCP7ES	5030	BKR6EKUE	6292	BP6EY	7727	BPR5EIX-11	2115	BR4ES	1097
BCPR5E-11	1273	BKR6E-N-11	5724	BP6HS	7331	BPR5EY	5685	BR4HS	3322
BCPR5EGP	7086	BKR6EP-11	2978	BP6HS-10	6326	BPR5EP-11	3971	BR4-LM	4133
BCPR5EIX	5688	BKR6EP-8	2215	BP7EFS	3526	BPR5ES	7734	BR5ES	5866



# Part Number to Stock Number

THE IGNITION SPECIALIST

NGK PART NO.	NGK STK NO.	NGK PART NO.	NGK STK NO.	NGK PART NO.	NGK STK NO.	NGK PART NO.	NGK STK NO.	NGK PART NO.	NGK STK NO.
BR5HS	3722	BR9ES S25	714	CMR8H	95741	CR9EIX	3521	DIMR8C10	92743
BR6EB-L-11	6931	BR9ES S25 SOLID	5984	CPR6EA-9	6899	CR9EK	4548	DP6EA-9	1068
BR6EF	3177	BR9ES SOLID	3194	CPR6EA-9S	1582	CR9EK BLYB	1493	DP7EA-9	5629
BR6ES	4922	BR9ES SOLID BLYB	1470	CPR6EB-9	5958	CR9EKB	2305	DP8EA-9	5829
BR6ES-11	3824	BR9EYA	7548	CPR7EA-9	3901	CR9EKPA	7785	DP9EA-9	6629
BR6FIX	2318	BR9EYA BLYB	1471	CPR7EAIX-9	9198	CS6 S100	1716	DPR5EA-9	2887
BR6FS	4323	BR9EYA S25	7679	CPR8E	7411	CZ104	9810	DPR6EA-9	5531
BR6FS S25	708	BR9HIX	5687	CPR8EA-9	2306	CZ159	92053	DPR6EA-9 BLYB	92482
BR6HIX	3419	BR9HS	4522	CPR8EB-9	6607	CZ303	9970	DPR6EB-9	3108
BR6HS	3922	BR9HS-10	4551	CPR9EA-9	2308	CZ551	92340	DPR7EA-9	5129
BR6HS BLYB	1507	BR9HS-10 BLYB	1472	CPR9EB-9	6508	D6EA	7512	DPR7EA-9 BLYB	91320
BR6HS-10	1090	BR9HS-10 S25	707	CR10E	6264	D6HA	6512	DPR7EIX-9	7803
BR6HSA	4296	BU8H	6431	CR10EIX	6482	D7EA	7912	DPR8EA-9	4929
BR6S	3522	BU8H BLYB	1473	CR10EK	2360	D8EA	2120	DPR8EA-9 BLYB	97768
BR7EF	3346	BU8H S25	703	CR4HSA	2430	D8HA	7112	DPR8EIX-9	2202
BR7EFS	1094	BUE	2322	CR4HSB	4695	D9EA	2420	DPR8Z	4730
BR7EIX	6664	BUH	2422	CR5EH-9	6689	DCPR6E	3481	DPR9EA-9	5329
BR7ES	5122	BUHW	2622	CR5HIX	7120	DCPR6E BLYB	96530	DPR9EIX-9	5545
BR7ES SOLID	6615	BUHW BLYB	1474	CR5HSA	7840	DCPR6EIX	8196	DPR9Z	4830
BR7ET	5877	BUHW S25	701	CR5HSB	6535	DCPR7E	3932	DR4HS	3326
BR7HIX	7067	BUHW-2	5626	CR5HSB BLYB	6786	DCPR7EGP	1682	DR5HS	4623
BR7HS	4122	BUHW-2 BLYB	1475	CR6E	6965	DCPR7EIX	6046	DR6HS	4823
BR7HS BLYB	1445	BUHW-2 S25	702	CR6EH-9	2688	DCPR7E-N-10	4983	DR7EA	7839
BR7HS S25	1207	BUHX	2522	CR6EIA-9	7967	DCPR8E	4339	DR7EB	5469
BR7HS-10	1098	BUHXW-1	5526	CR6HIX	7274	DCPR8E BLYB	92238	DR7EIX	5686
BR7HS-10 S25	1113	BUR4EB-11	5370	CR6HS	7023	DCPR8E SOLID	4179	DR7ES	3123
BR8ECM	3035	BUR5EB-11	6735	CR6HSA	2983	DCPR8EIX	6546	DR8EA	7162
BR8ECMIX	3520	BUR6EA-11	4690	CR6HSB	6500	DCPR8EKC	7168	DR8EA BLYB	97058
BR8ECS	4172	BUR6EB-11	7037	CR7E	4578	DCPR8EKP	7415	DR8EB	4855
BR8ECSIX	5886	BUR6ET	7517	CR7E BLYB	1482	DCPR9E	2641	DR8EIX	6681
BR8EG	3130	BUR7EA-11	7031	CR7EB	4663	DCPR9EIX	2316	DR8ES	5423
BR8EG SOLID	3992	BUR7EB-11	6832	CR7EH-9	3486	DF6H-11A	94702	DR8ES-L	2923
BR8EIX	5044	BUR7EB-11	6832	CR7EIA-9	91175	DF8H-11B	90174	DR8HS	5123
BR8EIX SOLID	6747	BUR7EQ	6917	CR7EIX	7385	DFH6B-11A	6858	DR9EA	3437
BR8EQ-14	2329	BUR7EQP	4764	CR7EK	7546	DIFR5C11	1311	DR9EIX	4772
BR8ES	5422	BUR9EQ	5777	CR7EKB	4455	DIFR6C11	1312	ER8EHIX	8201
BR8ES S25	713	BUR9EQP	5255	CR7HIX	7544	DIFR6D13	94167	ER9EH	5869
BR8ES SOLID	3961	BUZ8H	7447	CR7HS	7223	DILFR5A11	93759	ER9EHIX	96652
BR8ES SOLID BLYB	1463	BUZHW	2147	CR7HSA	4549	DILFR5A-11D	98376	FR2B-D	1598
BR8ES-11	7986	BUZHW-2	2173	CR7HSA BLYB	1488	DILFR5C11D	6159	FR4	5155
BR8ET	6612	BZ7HS-10	3579	CR7HSA-9	95372	DILFR5E11	92605	FR45	3686
BR8HCS-10	1157	C2H	2211	CR8E	1275	DILFR6D11	6176	FR45GP	3072
BR8HIX	7001	C-50	5712	CR8E BLYB	1490	DILFR6J11	92491	FR4GP	2685
BR8HS	4322	C6HSA	3228	CR8E S25	6997	DILFR7B10G	97218	FR5	7373
BR8HS BLYB	1466	C7E	5096	CR8EB	7784	DILFR7K9G	91961	FR5-1	7252
BR8HS Solid	6715	C7HSA	4629	CR8EH-9	5666	DILKAR6A11	9029	FR5AHX	95839
BR8HS-10	1134	C8E	7471	CR8EIX-9	3797	DILKAR7B11	1406	FR5AHX-E	92375
BR8HS-10 BLYB	1468	C8EH-9	7473	CR8EIA-10	4708	DILKAR7B8	92217	FR5AP-10	6371
BR8HS-10 S25	709	C8HA	2168	CR8EIA-9	4286	DILKAR7C9H	91215	FR5AP-11	5463
BR8HSA	5539	C8HSA	6821	CR8EIB-10	4948	DILKAR7G11GS	91578	FR5AP-11E	6569
BR9ECM	3252	C9E	7499	CR8EIB-9	5258	DILKAR7H11GS	96964	FR5BHX	96457
BR9ECMIX	2707	CM-6	5812	CR8EIX	4218	DILKAR8A8	93026	FR5EI	1313
BR9ECS	4677	CMR4A	5474	CR8EK	3478	DILKR6C11	93199	FR5GP	3248
BR9ECS-5	6669	CMR4H	5246	CR8EKB	4374	DILKR6D11G	95264	FR6AHX-S	94279
BR9ECSIX	5438	CMR5H	7599	CR8EKPA	6985	DILKR7A11	93135	FR6BHX-S	95159
BR9ECSIX-5	6014	CMR5H BLYB	6776	CR8HIX	7669	DILKR7B6	96957	FR6EI	2687
BR9EG	3230	CMR6A	1223	CR8HSA	2086	DILKR7C11	94731	FR7BHX-S	92400
BR9EG SOLID	4015	CMR6H	3365	CR9E	6263	DILKR7C11	94731	FR9BI-11	4709
BR9EG-N-8	2689	CMR6H BLYB	6778	CR9EB	6955	DILKR8B6	91448	G-2Z	3320
BR9EIX	3981	CMR7A	7543	CR9EB BLYB	1491	DILZKAR7B11	90935	GR4	2635
BR9EIX SOLID	3089	CMR7A BLYB	6784	CR9EH-9	7502	DILZKAR7C11S	90137	GR45	4268
BR9EQ-14	3129	CMR7A-5	4641	CR9EHI-9	6419	DILZKR7A11DS	90074	GR45GP	3142
BR9ES	5722	CMR7H	3066	CR9EHIX-9	6216	DILZKR7A11G	92924	GR4GP	2763
BR9ES BLYB	1469	CMR7H BLYB	6785	CR9EIA-9	6289	DILZKR7B11G	95350	GR4IX	97382
		CMR7H-10	1656	CR9EIB-9	92579	DILZKR7B11GS	95710	GR5	2851
						DIMR8A10	5066		

NGK PART NO.	NGK STK NO.	NGK PART NO.	NGK STK NO.	NGK PART NO.	NGK STK NO.	NGK PART NO.	NGK STK NO.	NGK PART NO.	NGK STK NO.
GR5GP	3351	ILTR6E11	90117	LFRER7BHX	95125	LMAR9AI-10	93188	PFR5J-11	4642
GR5X	7214	ILTR6F9	90656	LFR4A-E	6499	LMAR9AI-8	97225	PFR5L-11	5459
GR9A-EG	94841	ILTR6G8G	96621	LFR5A-11	6376	LMAR9D-J	1633	PFR5N-11	5838
IFR5D10	4696	ILTR6H8G	96870	LFR5A-11 BLYB	95945	LMAR9E-J	6884	PFR5R-11	4292
IFR5E11	7994	ILTR6M9G	94489	LFR5A-11 S25	1116	LMAR9G	92222	PFR6A-11	4045
IFR5G11	7854	ILTR7E9	90543	LFR5AGP	5018	LR4C-E	94931	PFR6B	3500
IFR5G-11K	3107	ILTR7N8	95822	LFR5AHX	96355	LR8B	6208	PFR6B-11	4014
IFR5J11	7418	ILZFR6D11	1208	LFR5AIX-11	4469	LTR5AHX	90220	PFR6G	4793
IFR5L11	6502	ILZKAR7A10	6043	LFR6A	6668	LTR5BI-13	90083	PFR6G-11	5555
IFR5N10	7866	ILZKAR7B11	1654	LFR6A-11	3672	LTR5GP	5019	PFR6G-13	4115
IFR5T11	4996	ILZKAR7E11S	96509	LFR6A-11 BLYB	90537	LTR5JX-11	4344	PFR6G-13E	2341
IFR5T-8N	3508	ILZKAR8H8S	95112	LFR6A-11 S25	1119	LTR6AHX	91276	PFR6H-10	6290
IFR6B	6507	ILZKAR8J8SY	95660	LFR6AHX-S	94122	LTR6AI13	95853	PFR6J-11	2743
IFR6B11	5368	ILZKBR7B8DG	95770	LFR6AIX	93893	LTR6AI-9	96780	PFR6L-11	4639
IFR6B-K	4867	ILZKR7A	1961	LFR6AIX-11	6619	LTR6BHX	90495	PFR6L-13	3141
IFR6D10	5344	ILZKR7B11	7751	LFR6BHX	93420	LTR6BI-13	91725	PFR6N-11	3546
IFR6E11	6741	ILZKR7B-11S	5787	LFR6C-11	7787	LTR6BI-9	92182	PFR6Q	6458
IFR6F8DN	96416	ILZKR7D8	96412	LFR6CGP	1483	LTR6BP13	94806	PFR6T-10G	5542
IFR6G-11K	1314	ILZKR8A	94290	LFR6D	6490	LTR6CI-8	97177	PFR6U-11G	5874
IFR6J11	7658	ILZNAR8A7G	91924	LFR7A	92038	LTR6DI-8	96588	PFR6W-T	6740
IFR6L11	3678	ILZTR6A8G	94769	LFR7AIX	2309	LTR6DP13	90374	PFR6W-TG	5547
IFR6Q-G	5648	IMR8C-9H	3653	LKAR6AGP	95830	LTR6GP	90198	PFR6X-11	5757
IFR6T11	4589	IMR8E-9HES	95397	LKAR6AHX	97292	LTR6GP-8	94372	PFR7AB	93322
IFR6V-10G	92085	IMR9A-9H	6966	LKAR6AIX-11	91187	LTR6JX	94374	PFR7B	4853
IFR6Z7G	95609	IMR9B-9H	4888	LKAR7AGP-D	93220	LTR6JX-11	6509	PFR7G-11	2380
IFR7F-4D	5115	IMR9C-9H	6777	LKAR7AHX-S	92274	LTR7BHX	95605	PFR7G-11S	7772
IFR7F-8DS	5794	IMR9C-9HE	6501	LKAR7BGP-S	92649	LTR7CP13	94862	PFR7H-10	3978
IFR7G-11KS	7746	IMR9C-9HES	5766	LKAR7BIX-11S	93501	LTR7IX-11	6510	PFR7N8DS	93580
IFR7L11	5114	IMR9D-9H	6544	LKAR7C-9	93961	LZFR5AGP-E	90192	PFR7Q	7963
IFR7U-4D	93623	IMR9E-9HES	7556	LKAR8A-9	4786	LZFR5AIX-11E	92460	PFR7S8EG	1675
IFR7X7G	91039	ITR4A15	5599	LKAR8AI-9	6706	LZFR5BI-11	93298	PFR7W-TG	5592
IFR8H11	5068	ITR5H13	97287	LKAR8BHX	91784	LZFR5C-11	92174	PFR8S8EG	94460
IFR9H11	6588	ITR6F13	4477	LKAR8BI9	1553	LZFR5CI-11	92145	PGR5A-11	3573
IGR7A-G	3106	ITR6G9	90156	LKAR9BI-10	95371	LZFR6AI	3656	PGR5C-11	5760
IJR7A9	7901	IZFR5B	4080	LKAR9BI9	6205	LZFR6AP11GS	95712	PGR6A	4984
IKR7H8	91715	IZFR5G	5887	LKR6AHX	91356	LZKAR7A	6799	PGR7A	3200
ILFR5B11	1637	IZFR5J	5899	LKR6BGP-E	96002	LZKAR6AGP-E	94017	PJR7A	2842
ILFR5T11	96779	IZFR5K11	3657	LKR6BHX-E	93763	LZKR6AIX	92873	PKR7A	3641
ILFR6A	3588	IZFR5L11	97932	LKR6CIX	93126	LZKR6AIX	92873	PLFER7A8EG	94833
ILFR6B	6481	IZFR6F11	4095	LKR6E	92650	LZMAR8AI-10	94021	PLFR5A-11	6240
ILFR6G-E	4212	IZFR6H11	4294	LKR6E-9N	90410	LZTR4A-11	5306	PLFR6A-11	7654
ILFR6J-11K	4458	IZFR6J	4462	LKR7AHX-S	96358	LZTR4AGP	5017	PLFR6C-10G	1959
ILFR6T11	4904	IZFR6K11	6994	LKR7AIX	93911	LZTR4AIX-11	2313	PLKR6A	5149
ILFR7H	5245	IZFR6K-11E	6748	LKR7B-9	5847	LZTR5A-13	4306	PLKR7A	4288
ILKAR7B11	4912	IZFR6K-11S	5266	LKR7BGP-8	95983	LZTR5AGP	3381	PLKR7B8E	94716
ILKAR7C10	94940	IZFR6K13	6774	LKR7BGP-S	97390	LZTR5AIX-13	2314	PLTR6A-10G	3587
ILKAR7L11	94124	IZFR6N-E	4757	LKR7BHX	94705	LZTR6AIX-13	2315	PLZFR5B13EG	97606
ILKAR8H6	96024	IZFR6Q	91234	LKR7DIX-11S	93175	LZTR6AP11EG	97408	PLZFR6A-11S	5987
ILKR7B8	1989	IZFR7M	4214	LKR7E	1643	LZTR7AIX-13	5107	PLZKAR6A-11	5118
ILKR7E6	93053	IZFR7M6D	90856	LKR8A	5214	MAR10A-J	4706	PLZKBR7B8DG	90223
ILKR8E6	1422	IZKR7B	7563	LKR8AP	4471	MAR8B-JDS	8765	PLZTR4A-13	4997
ILKR8Q7	93819	IZTR4A11	4213	LKR8BHX-S	90465	MAR9A-J	6869	PLZTR5A-13	4998
ILKR9Q7G	97312	IZTR5B11	1465	LMAR6A-9	5946	MR7BI-8	90982	PMR7A	4259
ILMAR7E9	94698	J10A	7444	LMAR6C-9	1679	MR7F	95897	PMR8A	5851
ILNAR8B7G	91970	J9A	2170	LMAR7A-9	4908	MR8AI9	7692	PMR8B	6378
ILTR5B11	3474	JR10B	1299	LMAR7DI-10	96956	MR8BI-8	91360	PMR8C-H	96361
ILTR5C11	5581	JR8C	5139	LMAR8A-9	4313	MR8F	90299	PMR9B	4717
ILTR5D	5476	JR9B	3188	LMAR8A-9S	6817	MR9F	95884	PTR4B-15	5146
ILTR5E11	91418	JR9C	6193	LMAR8AI-8	92288	PFR5A-11	4588	PTR4G-15	1209
ILTR5K13	90607	KR8AI	5477	LMAR8BI-9	91909	PFR5B-11	2300	PTR5A-13	2467
ILTR5L11	96329	KR8DI	4742	LMAR8C-9	93833	PFR5B-11B	2867	PTR5C-13	7740
ILTR5M9G	90882	KR9C-G	90893	LMAR8D-J	93444	PFR5C-11	2271	PTR5D-10	3784
ILTR6A-8G	3787	KR9CI	7795	LMAR8F-9	90894	PFR5G-11	2647	PTR5D-13	6644
ILTR6B11	5367	KR9E-G	93226	LMAR8G	95627	PFR5G-13E	2761	PTR5F-11	6579



# Part Number to Stock Number

THE IGNITION SPECIALIST

NGK PART NO.	NGK STK NO.	NGK PART NO.	NGK STK NO.	NGK PART NO.	NGK STK NO.	NGK PART NO.	NGK STK NO.	NGK PART NO.	NGK STK NO.
PTR6D-13	5598	R5724-9	7891	SILZKR6D8E	91568	XR4IX	7189	Y-732J	5909
PZFR5D-11	7968	R6061-10	5962	SILZKR7B11	9723	XR5	3332	Y-745U	4705
PZFR5F	3741	R6061-11	2773	SILZKR7B8E	93411	XR5IX	7355	Y-752M	6198
PZFR5F-11	4363	R6061-9	4074	SILZKR7E11	92315	Y1002AS	8926	Y-757RS	4018
PZFR5J-11	7743	R6252E-105	2396	SILZKR7E8EG	93655	Y1021J	97627	Y-766MS	4143
PZFR5Q-11	6737	R6252K-105	2741	SILZKR7E9G	91467	Y-103	6125	Y-809-1	2831
PZFR6E-11	7790	R6254E-105	3949	SILZNR6D9	94051	Y1032AS	97788	Y-810	6929
PZFR6F	6876	R6254E-9	5583	SILZNR8C7H	93593	Y1033AS	90046	Y-874-1	5326
PZFR6F-11	3271	R6254K-105	4076	SIMR8A9	91064	Y1037J	97928	Y-918J	3704
PZFR6H	7696	R6601-10	4017	SIZKBR8A8HS	1555	Y-103K	6325	Y-924J	3473
PZFR6J-11	3586	R6601-11	4586	SPMR8A6HDG	92264	Y-103V	2031	Y-925J	5740
PZFR7G-G	4253	R6725-105	3857	TR4	3754	Y-104	6425	Y-930U	5568
PZNR6A11H	5507	R6725-11	4311	TR45-1GP	5684	Y-106-1	6525	YA01	5727
PZTR5A-15	7862	R6725-115	4482	TR45-1IX	6744	Y-106V	6926	YE01	2649
R0045J-11	7043	R6918B-7	6259	TR45-1IX	6744	Y-107-1	6625	YR5	7052
R0045J-9	5861	R6918B-8	4492	TR4BHX	97100	Y-107R	1229	YR55	7240
R0045Q-10	4216	R6918B-9	2954	TR4GP	2815	Y-107V	6628	YR55IX	7588
R0045Q-11	5957	R6918C-9	5196	TR4IX	7300	Y-110	6825	YR5GP	2953
R0045Q-9	3235	R7282-10	2000	TR5	2238	Y-112M1	2531	YR5IX	7516
R0161-10	4778	R7282-105	4985	TR5-1	7060	Y-112RS1	1132	ZFR4F-11	4043
R0373A-10	4940	R7376-10	4457	TR5-1GP	3716	Y-112TS	1232	ZFR5A-11	5084
R0373A-11	5566	R7376-8	5442	TR5-1IX	7243	Y-113V	5162	ZFR5AIX-11	94553
R0373A-9	3388	R7376-9	7763	TR55	3951	Y-114T	6528	ZFR5AP	92041
R0406A-8	1480	R7420-10	5501	TR55-1	2683	Y-115R1	2161	ZFR5BGP	90804
R0406A-9	1481	R7420-105	4857	TR55-1GP	7159	Y-117RS	2930	ZFR5D-11	4936
R0409B-8	7791	R7420-11	7756	TR55-1IX	7316	Y-118R	2187	ZFR5E-11	4435
R0451B-8	9356	R7420-9	6448	TR55GP	3403	Y-119V	7465	ZFR5EGP	7096
R0465B-10	7506	R7433-9	4660	TR55IX	7164	Y-122	6925	ZFR5F	7558
R2349-10	6839	R7434-10	4894	TR5AHX	94567	Y-146R	7492	ZFR5F-11	2262
R2525-10	5281	R7435-10	4897	TR5AI-13	90813	Y-147T	7493	ZFR5F-4	96830
R2525-9	4735	R7437-8	4901	TR5BP12	93858	Y-149	6766	ZFR5FGP	7098
R2556B-10	1997	R7437-9	4654	TR5C-12	92838	Y-154	7125	ZFR5FGP-8E	92459
R2556B-8	6453	R7438-8	4905	TR5GP	3186	Y-202-2	3226	ZFR5FGP-E	94407
R2556B-9	4962	R7438-9	4656	TR5IX	7397	Y-203	2532	ZFR5FIX-11	2477
R2556G-10	91185	R7440A-10L	4282	TR6	4177	Y-203V	7728	ZFR5FIX-11E	96807
R2556G-8	91975	R8102B-10	95746	TR65IX	3692	Y-204RS	4573	ZFR5FIX-E	95332
R2556G-9	93253	RE7C-L	6700	TR65IX	3692	Y-204TS1	3829	ZFR5J-11	5584
R2558E-9	97537	RE9B-T	6701	TR6AHX	92714	Y-207T	1239	ZFR5LP-13G	7781
R5184-105	3334	SIFR6A11	127	TR6AP-13	5809	Y-208T	1250	ZFR5N	3459
R5670-5	2298	SIKR9A7	93618	TR6AP-13E	4968	Y-271-2	7467	ZFR6A-11	1041
R5670-6	2746	SILFR5A11	92373	TR6GP	5141	Y-301V	7238	ZFR6AGP	7094
R5670-7	2891	SILFR6A	7913	TR6IX	3689	Y-306R	6244	ZFR6AIX-11S	97138
R5670-8	3354	SILFR6A11	5468	TR7IX	3690	Y-314	4646	ZFR6BGP-S	92213
R5670-9	3913	SILFR6B8	373	TR8IX	3691	Y4002J	97190	ZFR6F-11	4291
R5671A-10	5820	SILFR6C11	7505	UR4	6630	Y-401-3	2226	ZFR6F-11 BLYB	90760
R5671A-11	6596	SILKR8A-S	1402	UR45	6945	Y-408JS	5616	ZFR6F-11G	6987
R5671A-7	4091	SILKR8B8DS	95705	UR45GP	3207	Y-510R	91712	ZFR6FGP	7100
R5671A-8	4554	SILMAR10A9S	7764	UR45IX	7559	Y-543J	6600	ZFR6FIX-11	6441
R5671A-9	5238	SILMAR7A9S	93675	UR4GP	2869	Y-546J	95275	ZFR6J-11	5585
R5672A-10	7942	SILMAR8A9S	90992	UR4IX	7401	Y-608J	8756	ZFR6K-9E	92566
R5672A-8	7173	SILMAR9A9S	6213	UR5	2771	Y-701R	7464	ZFR6T-11G	5960
R5672A-9	7405	SILMAR9B9	95399	UR55	2248	Y-701RS	2765	ZFR6U-9	90318
R5673-10	4050	SILNAR7B7	93227	UR55IX	7272	Y-702R	1065	ZFR7F	5913
R5673-6	2405	SILTR6A7G	95369	UR5GP	3547	Y-702U	2966	ZFR7F-11	6855
R5673-7	2817	SILZKAR7B11	93482	UR5IX	7177	Y-703R	3782	ZGR5A	5077
R5673-8	3249	SILZKAR7E8S	93476	UR6	7773	Y-706R	3041	ZGR5A-4	90178
R5673-9	3442	SILZKBR8D8S	97506	UR6GP	7966	Y-707RS	4937	ZGR5AGP	7102
R5674-10	6702	SILZKBR8E8S	96987	UR6IX	7348	Y-709R	3238	ZGR5C	6334
R5674-6	4449	SILZKFR8D7S	95875	WR4-1	4652	Y-710J	7880	ZMR7AP	6914
R5674-7	5034	SILZKFR8E7S	90654	WR5	2438	Y-711J	5264	ZNAR6AGP	1698
R5674-8	5657	SILZKGR8B8S	94201	WR5IX	7510	Y-716RS	4693	ZNAR6AIX-11	372
R5674-9	6468	SILZKGR8C8S	95248	XR4	5858	Y-719RS1	6900	ZNAR7AIX	7554
R5724-10	7993	SILZKR6B10E	93815	XR45	4536	Y-720U1	5392		
R5724-8	7317	SILZKR6B11	6215	XR45IX	7293	Y-724U	3973		



ATV		
Rank	Stock No.	Part No.
1	6953	BKR5E-11
2	6962	BKR6E
3	4929	DPR8EA-9
4	4339	DCPR8E
5	5129	DPR7EA-9
6	4549	CR7HSA
7	7938	BKR5E
8	4629	C7HSA
9	4644	BKR7E
10	1275	CR8E

Power Equipment		
Rank	Stock No.	Part No.
1	2460	BKR5ES
2	2015	BPR2ES SOLID
3	3922	BR6HS
4	6726	BPMR6A
5	4008	BPR6ES SOLID
6	3841	BR2-LM SOLID
7	6021	BM6A SOLID
8	4006	BPR5ES SOLID
9	7472	BPM7A SOLID
10	4002	BMR6A SOLID

Blister Pack BLYB		
Rank	Stock No.	Part No.
1	6761	BPMR7A BLYB
2	6775	BPR6ES BLYB
3	6749	BMR6A BLYB
4	6719	BKR5E BLYB
5	6773	BPR5ES BLYB
6	6787	BR2-LM BLYB
7	6720	BM6F BLYB
8	6778	CMR6H BLYB
9	1469	BR9ES BLYB
10	6763	BPMR8Y BLYB

Marine		
Rank	Stock No.	Part No.
1	6376	LFR5A-11
2	4322	BR8HS
3	3922	BR6HS
4	3481	DCPR6E
5	6431	BU8H
6	4838	BP8H-N-10
7	3672	LFR6A-11
8	1134	BR8HS-10
9	5126	B8HS-10
10	5531	DPR6EA-9

Motorcycle		
Rank	Stock No.	Part No.
1	4929	DPR8EA-9
2	4339	DCPR8E
3	5129	DPR7EA-9
4	4549	CR7HSA
5	3932	DCPR7E
6	6263	CR9E
7	2120	D8EA
8	3481	DCPR6E
9	1275	CR8E
10	4578	CR7E

Snowmobile		
Rank	Stock No.	Part No.
1	4339	DCPR8E
2	6263	CR9E
3	3194	BR9ES SOLID
4	6955	CR9EB
5	3961	BR8ES SOLID
6	1275	CR8E
7	7548	BR9EYA
8	7788	BPR9ES
9	3521	CR9EIX
10	4677	BR9ECS

Non- Auto Iridium IX		
Rank	Stock No.	Part No.
1	4469	LFR5AIX-11
2	6418	BKR6EIX
3	6341	BKR5EIX
4	3521	CR9EIX
5	2667	BKR7EIX
6	6046	DCPR7EIX
7	2309	LFR7AIX
8	4218	CR8EIX
9	5044	BR8EIX
10	3981	BR9EIX

Shop packs		
Rank	Stock No.	Part No.
1	1195	BPMR7A S25
2	92628	BPM8Y S25 SOLID
3	1119	LFR6A-11 S25
4	1116	LFR5A-11 S25
5	740	B2-LM S25
6	1172	BKR5E S25
7	708	BR6FS S25
8	709	BR8HS-10 S25
9	1194	BPMR6A S25
10	1006	BPR6EFS S25



### INTRODUCTION

Spark plugs are one of the most misunderstood components of an engine.

This guide was designed to assist the technician, hobbyist, or race mechanic in understanding, installing, and troubleshooting spark plugs. The information contained in this guide applies to all types of internal combustion engines. Two stroke engines, rotary engines, high performance/ racing engines and street vehicles.

Spark plugs are the window into your engine (your only eyewitness to the combustion chamber), and hence can be used as a valuable diagnostic tool. Like a patient's thermometer, the spark plug displays symptoms and conditions of the engine's performance. The experienced tuner will analyze these symptoms to track down the root cause of any problems or to determine air/fuel ratios.

### BASICS:

The spark plug has two primary functions:

- 1) To ignite the air/fuel mixture
- 2) Remove heat away from the spark plug tip

Spark plugs transmit electrical energy that turn fuel into working energy. A sufficient amount of voltage must be supplied by the ignition system to cause it to spark across the spark plug's gap. This is called electrical performance.

Additionally, the temperature of the spark plug's firing end must be kept low enough to prevent pre-ignition, but high enough to prevent fouling. This is called thermal performance and is determined by the heat range selected.

It is crucial to remember that spark plugs **CANNOT create heat**, they can only **remove** heat. The spark plug works as a **heat-exchanger** by pulling unwanted thermal energy away from the combustion chamber and transferring the heat to the engine's cooling system. The heat range is defined as a plug's ability to dissipate heat. The rate of heat transfer is determined by:

- 1) The insulator nose length
- 2) Gas volume around the insulator nose
- 3) Materials / construction of center electrode and ceramic insulator

A spark plug's heat range has no relationship to the actual voltage transferred through the spark plug. Rather, the heat range is a measure of the spark plug's ability to remove heat from the combustion chamber. The heat range measurement is determined by several factors; the length of the ceramic center insulator nose and its ability to absorb and transfer combustion heat, the material composition of the insulator and center electrode material.

**HEAT RATING AND HEAT FLOW PATH OF SPARK PLUGS**

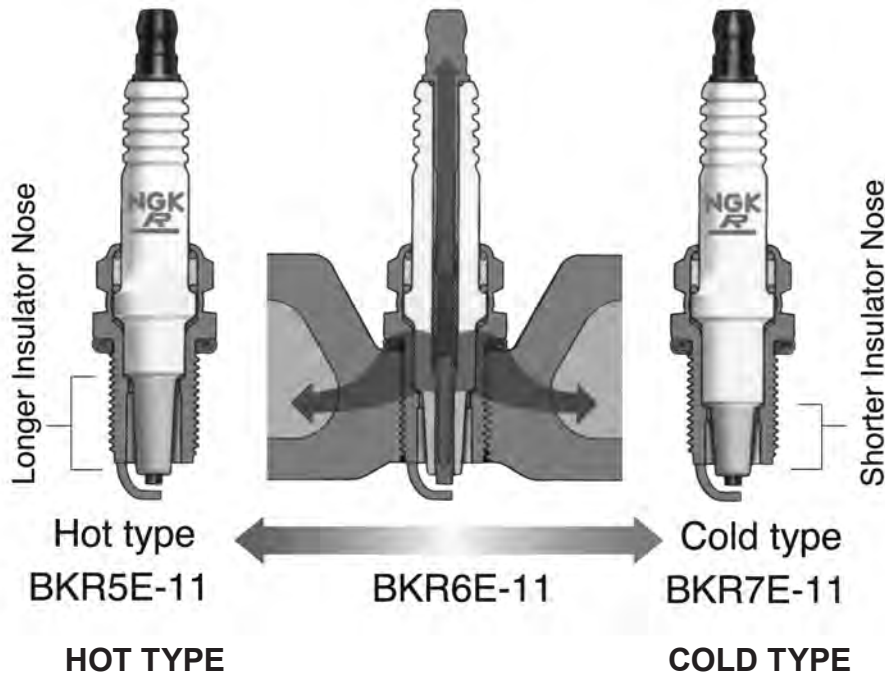

**HOT TYPE**  
It has a larger surface exposed to the combustion gasses. It dissipates heat slowly. Its firing end heats up quickly.

**COLD TYPE**  
It has a smaller surface exposed to the combustion gasses. It dissipates heat quickly. Its firing end does not heat up quickly.

The insulator nose length is the distance from the firing tip of the insulator to the point where the insulator meets the metal shell. Since the insulator tip is the hottest part of the spark plug, the tip temperature is a primary factor in pre-ignition and fouling. Whether the spark plugs are fitted in a lawnmower, boat, or a race car, the spark plug tip temperature must remain between 450°C-850°C. If the tip temperature is lower than 450°C, the insulator area surrounding the center electrode will not be hot enough to burn off carbon and combustion chamber deposits. Accumulated deposits can result in spark plug fouling leading to misfire.

If the tip temperature is higher than 850°C the spark plug will overheat which may cause the ceramic around the center electrode to blister and the electrodes to melt. This may lead to pre-ignition/detonation and expensive engine damage. In identical spark plug types, the difference from one heat range to the next is the ability to remove approximately 70°C to 100°C from the combustion chamber. A projected style spark plug firing temperature is increased by 10°C to 20°C.

## Spark Plug Heat Range

### SPARK PLUG TIP TEMPERATURE AND FIRING END APPEARANCE

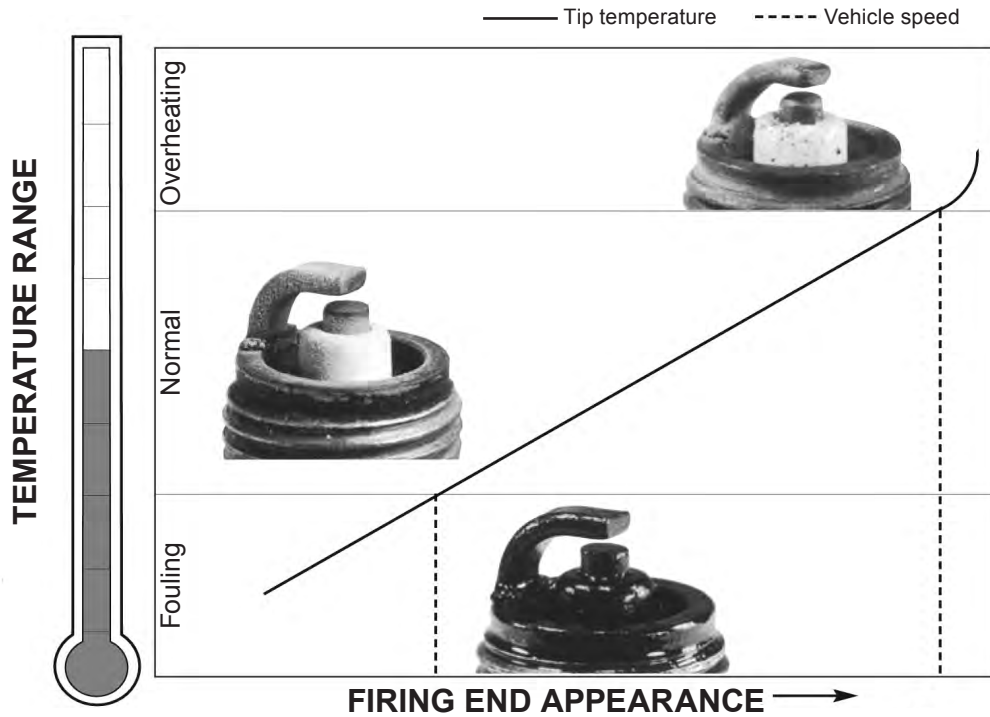

The firing end appearance also depends on the spark plug tip temperature. There are three basic diagnostic criteria for spark plugs: good, fouled and overheated. The borderline between the fouling and optimum operating regions (450°C) is the spark plug self-cleaning temperature. The temperature at this point is where the accumulated carbon and combustion deposits are burned off.

Bearing in mind that the insulator nose length is a determining factor in the heat range of a spark plug, the longer the insulator nose, the less heat is absorbed, and the further the heat must travel into the cylinder head water journals. This means the plug has a higher internal temperature, and is said to be a hot plug. A hot spark plug maintains a higher internal operating temperature to burn off oil and carbon deposits, and has no relationship to spark quality or intensity.

Conversely, a cold spark plug has a shorter insulator nose and absorbs more combustion chamber heat. This heat travels a shorter distance, and allows the plug to operate at a lower internal temperature. A colder heat range can be necessary when the engine is modified for performance, subjected to heavy loads, or is run at high rpms for a significant period of time. The colder type removes heat more quickly, and will reduce the chance of pre-ignition/detonation and burn-out of the firing end. (Engine temperature can affect the spark plug's operating temperature, but not the spark plug's heat range).

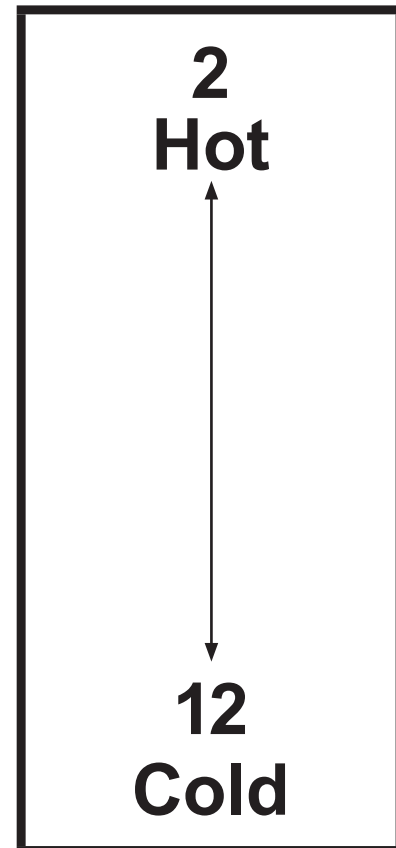

Below is a list of some of the possible external influences on a spark plug's operating temperatures. The following symptoms or conditions may have an effect on the actual temperature of the spark plug. The spark plug cannot create these conditions, but it must be able to cope with the levels of heat, if not, the performance will suffer and engine damage can occur.

**Air/Fuel Mixtures** seriously affect engine performance and spark plug operating temperatures.

- Rich air/fuel mixtures cause tip temperature to drop, causing fouling and poor driveability.
- Lean air/fuel mixtures cause plug tip and cylinder temperature to increase resulting in pre-ignition, detonation, and possibly serious spark plug and engine damage.
- It is important to read spark plugs many times during the tuning process to achieve optimum air/fuel mixture.

**Higher Compression Ratios/Forced Induction** will elevate spark plug tip and in-cylinder temperatures

- Compression can be increased by performing any one of the following modifications:
  - a) reducing combustion chamber volume (domed pistons, smaller chamber heads, milling heads, etc.)
  - b) adding forced induction (Nitrous, Turbocharging or Supercharging)
  - c) camshaft change
- As compression increases, a colder heat range plug, higher fuel octane, and careful attention to ignition timing and air/fuel ratios are necessary. Failure to select a colder spark plug can lead to spark plug/engine damage.

**Advancing Ignition Timing**

- Advancing ignition timing by 10° causes plug tip temperature to increase by approximately 70°-100° C.

**Engine Speed and Load**

- Increases in firing-end temperature are proportional to engine speed and load. When traveling at a consistent high rate of speed, or carrying/pushing very heavy loads, a colder heat range spark plug should be installed.

**Ambient Air Temperature**

- As air temperature falls, air density/air volume becomes greater, resulting in leaner air/fuel mixtures.
- This creates higher cylinder pressures/temperatures and causes an increase in the spark plug's tip temperature. So, fuel delivery should be increased.
- As temperature increases, air density decreases, as does intake volume, and fuel delivery should be decreased.

**Humidity**

- As humidity increases, air intake volume decreases.
- Result is lower combustion pressures and temperatures, causing a decrease in the spark plug's temperature and a reduction in available power.
- Air/fuel mixture should be leaner, depending upon ambient temperature.

**Barometric Pressure/Altitude**

- Affects the spark plug's tip temperature.
- The higher the altitude, the lower cylinder pressure becomes. As the cylinder temperature decreases, so does the plug tip temperature.
- Rather than tuning by changing spark plug heat ranges, adjust jetting or air/fuel mixtures to put air back into an engine.

### TYPES OF ABNORMAL COMBUSTION

#### Pre-ignition

- Defined as: ignition of the air/fuel mixture before the pre-set ignition timing mark.
- Caused by hot spots in the combustion chamber...can be caused (or amplified) by over advanced timing, too hot a spark plug, low octane fuel, lean air/fuel mixture, too high compression, or insufficient engine cooling.
- A change to a higher octane fuel, a colder plug, richer fuel mixture, or lower compression may be in order
- You may also need to retard ignition timing, and check vehicle's cooling system.
- Pre-ignition usually leads to detonation; pre-ignition and detonation are two separate events.

#### Detonation

- The spark plug's worst enemy (besides fouling).
- Can break insulators or break off ground electrodes.
- Pre-ignition most often leads to detonation.
- Plug tip temperatures can spike to over 1648°C (3000°F) during the combustion process (in a race motor).
- Most frequently caused by hot spots in the combustion chamber. Hot spots will allow the air/fuel mixture to pre-ignite. As the piston is being forced upward by mechanical action of the connecting rod, the pre-ignited explosion will try to force piston downward. If piston can't go up (because of the force of the premature explosion) and it can't go down (because of the upward motion of the connecting rod), the piston will rattle from side to side. The resulting shock wave causes an audible pinging sound. This is detonation.
- Most of the damage that an engine sustains when "detonating" is from excessive heat.
- The spark plug is damaged by both the elevated temperatures and the accompanying shock wave, or concussion.

#### Misfires

- A spark plug is said to have misfired when enough voltage has not been delivered to light off all fuel present in the combustion chamber at the proper moment of the power stroke (a few degrees before top dead center).
- A spark plug can deliver a weak spark (or no spark at all) for a variety of reasons a: defective coil, too much compression with incorrect plug gap, dry fouled or wet fouled spark plugs, insufficient ignition timing, etc.
- Slight misfires cause a loss of performance for obvious reasons if fuel is not lit, no energy is being created.
- Severe misfires will cause poor fuel economy, poor driveability, and can lead to engine damage.

#### Fouling

- Will occur when spark plug tip temperature is insufficient to burn off carbon, fuel, oil or other deposits.
- Will cause spark to leach to metal shell: no spark across plug gap will cause a misfire.
- Wet-fouled spark plugs must be changed as spark plugs will not fire.
- Dry-fouled spark plugs can sometimes be cleaned by bringing engine up to operating temperature.
- Before changing fouled spark plugs, be sure to eliminate root cause of fouling.



## Gap

- Check gap on every plug prior to installation.
- Always use factory recommendations for gap size, unless engine is modified.
- When checking gap, use only wire gauges; flat feeler or dial gauges do not accurately measure true width of spark-gap.
- When increasing gap size for high-performance ignition systems (MSD box, etc.) never go plus/minus more than .008" in order to retain parallel surfaces between ground and center electrode.
- When gapping, never use the center electrode as a fulcrum/leverage point...cracked center electrodes can result.
- Higher compression or boosted engines require smaller gaps and high powered ignition systems.

## Spark Plug Torque

- Torque is the most critical part of installation, as it directly influences spark plug temperatures.
- A spark plug can only transfer heat effectively when it is fully seated on the cylinder head. Under-torqued spark plugs can allow combustion gas leakage, or will not allow the plug to remove heat effectively causing spark plug and cylinder temperatures rise dramatically, eventually leading to detonation, plug/engine damage.
- Over-torquing can cause distortion /warping of spark plug's internal seals, causing poor heat transfer or plug temperature increase. This eventually leads to detonation, plug/engine damage.
- Before installation, clean threads to prevent encountering resistance from carbon build-up.
- When re-installing spark plugs, spark plug threads should be clean and particle-free to ensure proper seating.
- Iron and aluminum heads have different torque specs.

TORQUE SPECIFICATIONS*					
	THREAD SIZE	CAST IRON HEADS		ALUMINUM HEADS	
		WITH TORQUE WRENCH	WITHOUT TORQUE WRENCH	WITH TORQUE WRENCH	WITHOUT TORQUE WRENCH
FLAT SEAT W/ GASKET	18 mm	3.5 kg-m ~ 4.5 kg-m 25.3 lb-ft ~ 32.5 lb-ft	1/2- 2/3 turn 180° - 240°	3.5 kg-m ~ 4.0 kg-m 25.3 lb-ft ~ 28.9 lb-ft	1/2- 2/3 turn 180° - 240°
	14 mm	2.5 kg-m ~ 3.5 kg-m 18.0 lb-ft ~ 25.3 lb-ft	1/2- 2/3 turn 180° - 240°	2.5 kg-m ~ 3.0 kg-m 18.0 lb-ft ~ 21.6 lb-ft	1/2- 2/3 turn 180° - 240°
	12 mm	1.5 kg-m ~ 2.5 kg-m 10.8 lb-ft ~ 18.0 lb-ft	1/2- 2/3 turn 180° - 240°	1.5 kg-m ~ 2.0 kg-m 10.8 lb-ft ~ 14.5 lb-ft	1/2- 2/3 turn 180° - 240°
TAPERED SEAT	18 mm	2.0 kg-m ~ 3.0 kg-m 14.5 lb-ft ~ 21.6 lb-ft	1/12- 1/8 turn 30° - 45°	2.0 kg-m ~ 3.0 kg-m 14.5 lb-ft ~ 21.6 lb-ft	1/12- 1/8 turn 30° - 45°
	14 mm	1.5 kg-m ~ 2.5 kg-m 10.8 lb-ft ~ 18.0 lb-ft	1/12- 1/8 turn 30° - 45°	1.0 kg-m ~ 2.0 kg-m 7.2 lb-ft ~ 14.4 lb-ft	1/12- 1/8 turn 30° - 45°

\* Use of anti-seize is not recommended on NGK spark plugs.

All engine manufacturers have recommended torque specifications for spark plug installation, and most are represented in the chart above. Install the spark plug finger tight until the gasket or tapered seat contacts the cylinder head. Then give it the recommended turn or angle.



NGK Spark Plugs warrants that the products, which it sells to the Distributor, seller, reseller, or customer, shall be free from defects in workmanship or materials. Except in the case of damage or defect attributable to NGK Spark Plugs, the Distributor, seller, reseller, or customer shall have no claim against NGK Spark Plugs for any damaged or defective product or part. In the event that any products or parts shall prove to be defective in workmanship or materials within a period of sixty (60) days from the delivery thereof to the Distributor, seller, reseller, or customer, NGK Spark Plugs shall repair or replace the same without cost to the Distributor, seller, reseller or customer. Except as herein stated, NGK Spark Plugs shall not be liable for any damages or for the breach of any warranty, express or implied, or for any other obligation or liability on account of the products which it may sell to the Distributor, reseller, seller or customer.

(a) If during the term of this Contract the Distributor shall have reason to believe it has any claim against NGK Spark Plugs in respect of any transaction growing out of this Contract, the Distributor shall notify NGK Spark Plugs in writing within sixty (60) days after it knows or has reason to know the basis of any such claim.

(b) Failure to give the notice prescribed by Subsection (a) of this section shall relieve NGK Spark Plugs from all liability on any claim in respect to any transaction arising out of this Contract.

(c) The provisions of this section shall survive the termination of any other portions of this Contract.



THE IGNITION SPECIALIST

NGK's OE legacy, unsurpassed quality and leading vehicles in operation coverage reinforces NGK as The Ignition Specialist™. NGK's premium ignition products are manufactured to the highest durability and operational performance to meet OE standards. Each individual product line covers **over 95%** of domestic and import vehicles in operation.

**Product types include:**

- Spark Plugs
- Glow Plugs
- Ignition Coils
- Wire Sets
- Coil-on-plug-boots



THE SENSOR SPECIALIST

NTK's expansion from oxygen sensor to technical sensors is part of our ongoing commitment to streamline product types and increase coverage under one premium brand.

The only OE manufacturer with a full-line of technical sensors in the aftermarket, NTK technical sensors **offers over 85 product types with over 6,800 skus**. On average, shops perform nearly 30 technical sensor replacements every month.

**Sensor types include:**

- Position
- Pressure
- Speed
- Temperature
- Specialty
- Fluid Levels
- Emissions



The addition of a full-line brand portfolio for aftermarket vehicle electronics introduces over 22,000 skus, 215 product types for connectors, emissions, ignition, relays, solenoids and switch categories. Part of WVE's ongoing commitment is to streamline product types and increase coverage under one brand, without adding unnecessary design costs.

**Vehicle electronics types include:**

- Switches
- Emissions
- Relays
- Ignition
- Solenoids
- Connectors



Geared toward the modern technician, NGK Spark Plugs (U.S.A.), Inc.'s Technical Training combines the instruction of hands-on industry techniques and OEM expertise in a contemporary, lecture-style atmosphere. Focused on further defining diagnostic skills relating to emissions components, our training enables technicians to adapt to transitional industry trends.

YouTube [ngksparkplugsusa](https://www.youtube.com/ngksparkplugsusa)

Tech Support: (877) 473-6767 ext. 2



*THE IGNITION SPECIALIST™*



**Customer and Tech Assistance**  
877-473-6767



**NGK Spark Plugs (U.S.A.), Inc.**  
46929 Magellan Drive, Wixom, MI 48393



**ngksparkplugs.com**



**facebook.com/NGKSparkplugs**